

PACKAGE TERMINAL AIR CONDITIONER/HEAT PUMP

INSTALLATION INSTRUCTIONS & OWNER'S MANUAL

Standard and Remote Applications with LED Control

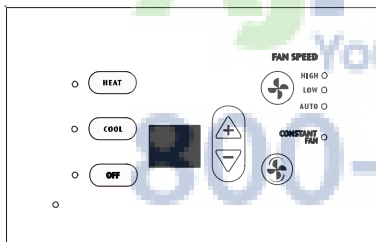
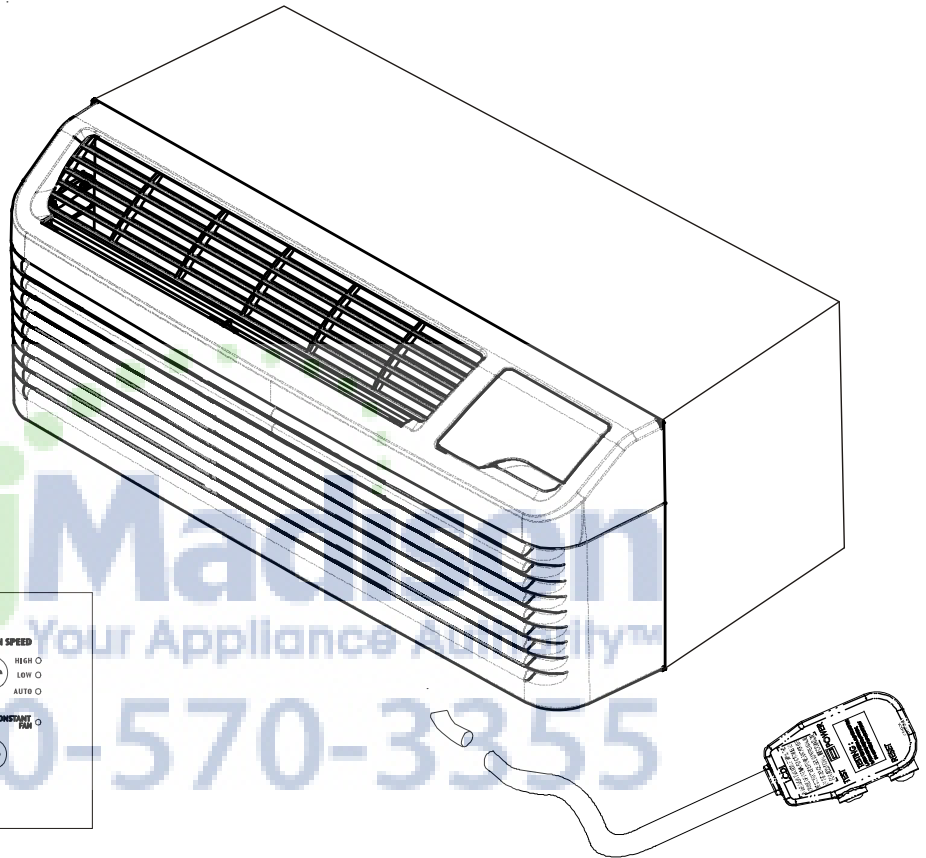

ATTENTION INSTALLING PERSONNEL

As a professional installer you have an obligation to know the product better than the customer. This includes all safety precautions and related items.

Prior to actual installation, thoroughly familiarize yourself with this Instruction Manual. Pay special attention to all safety warnings.

Often during installation or repair it is possible to place yourself in a position which is more hazardous than when the unit is in operation.

Remember, it is **your** responsibility to install the product safely and to know it well enough to be able to instruct a customer in its safe use.

Safety is a matter of common sense...a matter of thinking before acting. Most dealers have a list of specific good safety practices...follow them.

The precautions listed in this Installation Manual are intended as supplemental to existing practices. However, if there is a direct conflict between existing practices and the content of this manual, the precautions listed here take precedence.

This manual must be left with the owner of the equipment.



is a registered trademark of Maytag Corporation or its related companies and is used under license to Goodman Company, L.P., Houston, TX. All rights reserved.

IO-723A
February 2011

5151 San Felipe, Suite 500 • Houston, TX 77056 • www.amana-ptac.com

© 2009, 2011 Goodman Company, L.P.





Contents

Unit Features 2

Installation Instructions 5

Wiring 7

Operating Instructions 8

Maintenance and Cleaning 12

Obtaining Service 14

Normal Operating Sounds and Conditions 14

Configuration Settings 14

Configuration Chart 15

Diagnostic Maintenance & Status Report 16

Diagnostic Codes 17

IMPORTANT NOTE TO THE OWNER

This manual is to be used by qualified, professionally trained HVAC technicians only. Goodman does not assume any responsibility for property damage or personal injury for improper service procedures or services performed by an unqualified person.

IMPORTANT NOTES:

Your warranty certificate is also supplied with the unit. Read the warranty carefully and note what is covered. Keep the warranty certificate in a safe place, so you can find it, if necessary.

Before using this manual, check the serial plate for proper model identification.

THE INSTALLATION AND SERVICING OF THIS EQUIPMENT MUST BE PERFORMED BY QUALIFIED, EXPERIENCED TECHNICIANS ONLY.

Due to policy of continual product improvement, the right is reserved to change specifications and design without notice.

IMPORTANT NOTE TO THE SERVICER

Read this manual and familiarize yourself with the specific items which must be adhered to before attempting to service this unit. The precautions listed in this Installation Manual are intended as supplemental to existing practices. However, if there is a direct conflict between existing practices and the content of this manual, the precautions listed here take precedence.

 **RECOGNIZE THIS SYMBOL AS A SAFETY PRECAUTION.**

 **WARNING**

GOODMAN WILL NOT BE RESPONSIBLE FOR ANY INJURY OR PROPERTY DAMAGE ARISING FROM IMPROPER SERVICE OR SERVICE PROCEDURES. IF YOU INSTALL OR PERFORM SERVICE ON THIS UNIT, YOU ASSUME RESPONSIBILITY FOR ANY PERSONAL INJURY OR PROPERTY DAMAGE WHICH MAY RESULT. MANY JURISDICTIONS REQUIRE A LICENSE TO INSTALL OR SERVICE HEATING AND AIR CONDITIONING EQUIPMENT.

 **WARNING**

HIGH VOLTAGE
DISCONNECT ALL POWER BEFORE SERVICING OR INSTALLING THIS UNIT. MULTIPLE POWER SOURCES MAY BE PRESENT. FAILURE TO DO SO MAY CAUSE PROPERTY DAMAGE, PERSONAL INJURY OR DEATH.



UNIT FEATURES

This unit has many features which are different than those found on conventional PTAC units. The servicer must be familiar with these features in order to properly service the unit.

- **LCDI or AFCI Power Cords** - Underwriters Laboratories and the National Electric Code (NEC) now require power cords that sense current leakage and can open the electrical circuit to the unit on units rated at 250 volts or less. In the event that unit does not operate, check the reset button located on or near the head of the power cord as part of the normal troubleshooting procedure.

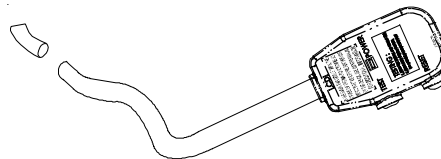

LCDI power Cord

- **Automatic 3-minute compressor lockout** - After the compressor cycles off, it will not restart for three minutes.
- **Automatic 2nd stage electric heat** - If the room temperature falls to 4°F below the set point temperature, the reverse cycle heat is shut off and the electric strip heat is turned on.

- **Automatic freeze protection** - Whenever power is supplied to the unit and the master switch is in the ON position, automatic freeze protection is active. If the unit senses temperature below 40°F, the fan motor and electric strip heat are turned on. Freeze protection can be turned off, if required.
- **Random restart delay** - To help eliminate power surges after a power outage, the unit is equipped with a two to four minute random restart delay feature. Whenever the unit is plugged in with the master switch turned on and the mode switch set in the cool or heat mode, a random restart will occur. A random restart condition can be avoided by setting the mode switch in the fan only or off position before applying power to the unit.
- **Fuse holder** - On all 265 volt units, fuse holders are factory installed. Check for blown fuse if unit does not operate. Fuse holder is located behind the front. Replacement fuses may be purchased from the Parts Department or contact your sales representative for part numbers.

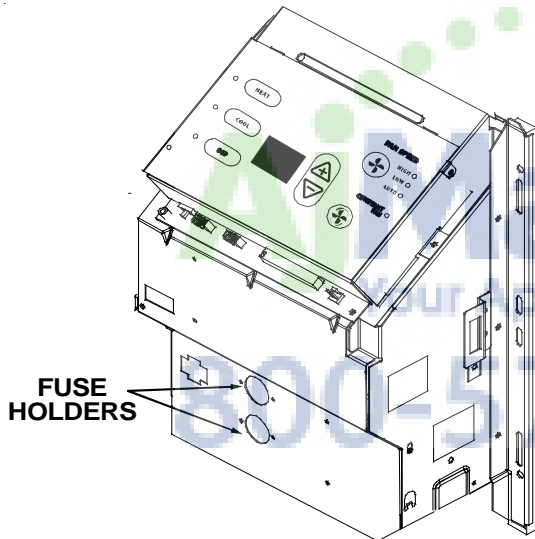

Control Panel

- **Indication LEDs** - The touch pad has LEDs that correspond to fan operation and to indicate unit status. The LEDs next to the selections OFF, COOL, and HEAT indicate which operational mode is active. The LED located in the lower left corner is a status LED. This LED indicates the status of the unit. See *Diagnostic Maintenance & Status Report* section for further details.

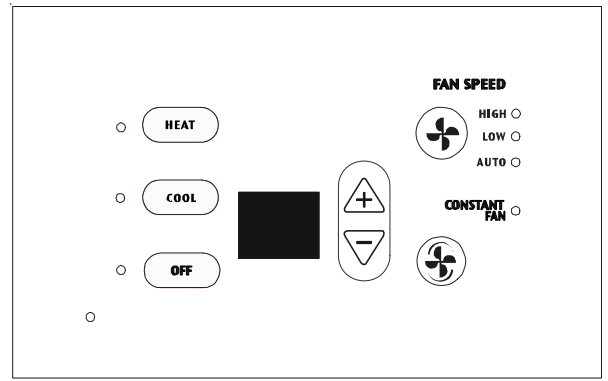

7 Button Touch Pad With Display

- **Load shedding** - An LS terminal has been added for load shedding operations. If at any time a switch is closed between the LS and IN terminals, the compressor and electric heater will lockout until the switch is opened.
- **Transfer fan** - Terminals TF(-) and TF(+) on the low voltage terminal board allow for an external (transfer) fan connection. A user-supplied relay is required and, depending upon the type used, an approved external transformer kit may be required for installation.

NOTE: The PTAC Wire Harness Kit (PWHK01C) is required when using either the transfer fan or load shedding option.

- **Front mounting hole** - A mounting hole location is provided to give the owner the option of securing the front to the chassis. The mounting hole must be drilled at the dimple indicating the correct location below a louver. The owner must supply one 1/2 inch long #8 sheet metal screw per unit. The screw must be removed before the front can be removed.

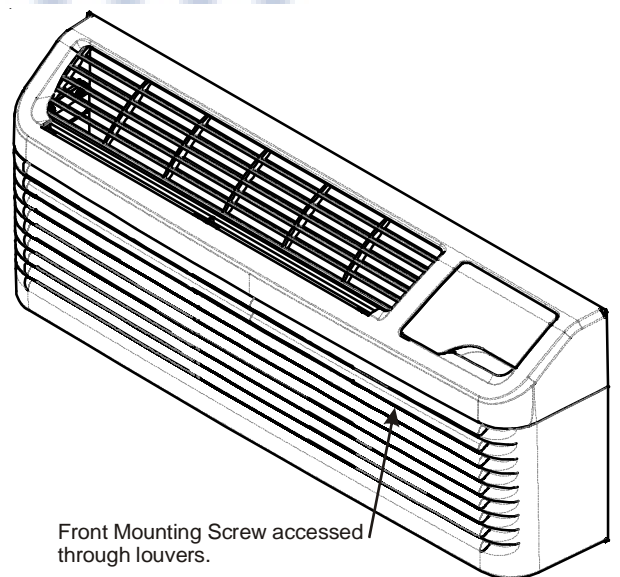

Chassis Front

• **Energy Management System Features**

Temperature Setback - This option can save energy dollars for unrented or unoccupied rooms by automatically setting back the operational temperatures. This mode of operation is selected through the configuration routine (see *Configuration Settings* section). **NOTE:** Temperature setback does not work with a wired remote thermostat.

Door Switch and Motion Sensor Low Voltage Terminals (DS1, DS2, MS1, MS2) - The door switch and motion sensor operate as a unit, the door switch terminals allows for wired connection of a door sensor to the control board. The motion sensor interprets any door movement as a signal of occupancy. If the switch between DS1 and DS2 is closed, the door control will interpret the room door as closed. If the switch between MS1 and MS2 terminals is opened (or closed if unit is configured for normally open) the control will interpret the action as a signal of occupancy. If thirty minutes pass without any door activity, Energy Management Temperature setback activates.

Serial Port Interfaces - Two serial ports located on the control board provide easy access for two-way communications to the control board from an optional RF antennae can be attached for wireless communications.

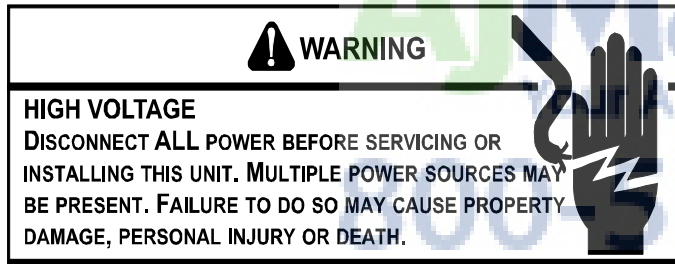

TRANSPORTATION DAMAGE

All units are securely packed in shipping containers tested according to International Safe Transit Association specifications. The carton must be checked upon arrival for external damage. If damage is found, a written request for inspection by the carrier's agent must be made immediately.

In the event of damage, the consignee must:

1. Make notation on delivery receipt of any visible damage to shipment or container.
2. Notify carrier promptly and request an inspection.
3. In case of concealed damage, carrier should be notified as soon as possible—preferably within 5 days.
4. File the claim with the following supporting documents within the 6 month statute of limitations.
 - a. Original Bill of Lading, certified copy, or indemnity bond.

- b. Original paid freight bill or indemnity in lieu thereof.
- c. Original invoice or certified copy thereof, showing trade and other discounts or reductions.
- d. Copy of the inspection report issued by carrier's representative at the time damage is reported to the carrier.

The carrier is responsible for making prompt inspection of damage and for a thorough investigation of each claim. The distributor or manufacturer will not accept claims from dealers for transportation damage.

UNIT ACCESSORIES

This unit is designed for through-the-wall installation in new or existing buildings. To complete the installation of this PTAC, an insulated wall sleeve and an outdoor grille (either the stamped aluminum grille, the architectural grille or polymer grille) are required.

The chassis and the cabinet front are shipped in one carton. Optional accessories to complete a particular installation are the following:



OPTIONAL ACCESSORIES

- | | |
|---------------------|-------------------------------|
| Power Switch Kit | Wire Harness Kit |
| Wall Sleeve Kit | Circuit Breaker Kit |
| Key Lock Kit | Architectural Grille Kit |
| Drain Kit | Remote Escutcheon Kit |
| Filter Kit | External Transformer Kit |
| Subbase Kit | Water or Steam Valve Kit |
| Hard Wire Kit | Condensate Disposal Pump Kit |
| Main Duct Kit | Remote Temperature Sensor Kit |
| Power Vent Kit | Wireless RF Antenna |
| Leveling Legs Kit | Wireless RF Thermostat |
| Hydronic Heat Kit | Wireless Motion Sensor |
| Stamped Grille Kit | Wireless Door Switch |
| Curtain Guard Kit | Wired Motion Sensor |
| Polymer Grille Kit | Wired Door Switch |
| Extension Duct Kit | Extra Deep Sleeves |
| Wall Thermostat Kit | |
| Fuse Holder Kit | |

NOTE: Consult sales literature for the appropriate voltage and amperage selections, if applicable. For additional details and illustrations of the accessories, refer to the Architect's and Engineer's Manual.

INSTALLATION INSTRUCTIONS

To ensure that the unit operates safely and efficiently, it must be installed, operated and maintained according to these installation and operating instructions and all local codes and ordinances or, in their absence, with the latest edition of the National Electric Code. The proper installation of this unit is described in the following sections. Following the steps in the order presented should ensure proper installation.

 WARNING	
HIGH VOLTAGE DISCONNECT ALL POWER BEFORE SERVICING. MULTIPLE POWER SOURCES MAY BE PRESENT. FAILURE TO DO SO MAY CAUSE PROPERTY DAMAGE, PERSONAL INJURY OR DEATH. DO NOT SERVICE THIS UNIT WITHOUT FIRST ENSURING THAT: THE ELECTRICAL ACCESSORIES ARE INSTALLED ONLY IN THE PRE-DRILLED MOUNTING HOLES. THE ELECTRICAL WIRING IS NOT INSTALLED AND DOES NOT HANG BELOW THE PRE-DRILLED MOUNTING HOLE OR LIE IN THE UNIT BASE PAN.	

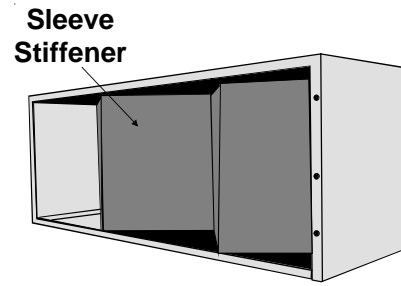

Wall Sleeve with Stiffener

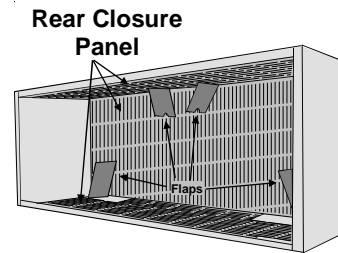

Stiffener Removal

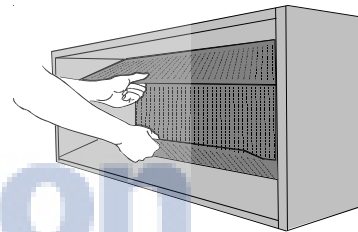

Rear Enclosure Panel Removal



SLEEVE STIFFENER AND REAR CLOSURE PANEL REMOVAL

Before the chassis can be installed in the wall sleeve, the sleeve stiffener and the rear closure panel must be removed.

1. Remove the zigzag folded cardboard sleeve stiffener.
2. Remove the rear closure panel by folding the four flaps.
3. Grasping the top and bottom flanges of the rear closure panel pull the entire panel out diagonally from one side.

DRAIN KIT INSTALLATION (OPTIONAL ACCESSORY)

During normal reverse cycle heating operation, condensate water will drain out of the rear of the wall sleeve. If this water is objectionable, a drain kit should be installed. The drain kit has provisions for draining the water from either the right or left side of the sleeve externally or from the bottom of the sleeve internally. The drain kit must be installed before the outdoor grille is installed. Refer to the Installation Instructions supplied with the drain kit for a complete description of the installation procedure.

 WARNING	
HIGH VOLTAGE DISCONNECT ALL POWER BEFORE SERVICING. MULTIPLE POWER SOURCES MAY BE PRESENT. FAILURE TO DO SO MAY CAUSE PROPERTY DAMAGE, PERSONAL INJURY OR DEATH. DO NOT SERVICE THIS UNIT WITHOUT FIRST SHUTTING OFF POWER TO THE UNIT FROM THE CIRCUIT BREAKER AND/OR REMOVING THE UNIT CORD SET PLUG FROM THE WALL OUTLET.	

SLEEVE INSTALLATION

In order for condensate water to drain properly inside the unit, the sleeve must be installed properly:

- Level from right to left.
- A slight downward pitch from the indoor side to the outdoor side as shown below.

Refer to the Installation Instructions supplied with the PTAC wall sleeve for a complete description of the installation procedure.

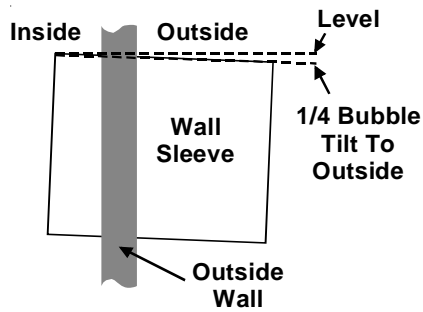

Proper Sleeve Tilt

OUTDOOR GRILLE

An outside grille must be installed to direct air flow for proper unit operation and also protect the outdoor coil. The grille must be installed before installing the chassis. Refer to the Installation Instructions supplied with the outdoor grille kit for a complete description of the installation procedure.

This model requires either a Stamped Grille Kit (Model SGK--B), a Polymer Grille Kit (Model PGK) or an Architectural Grille Kit (Model AGK--B). When replacing an old chassis with an existing grille or using a specialized grille in a new installation, please check with your sales representative to determine if the new chassis should be used with the non-standard specialized grille. An improper outdoor grille can decrease cooling or heating capacity, increase energy usage and shorten compressor life and possibly void the warranty.

FRONT REMOVAL

1. Grasp the cabinet front.

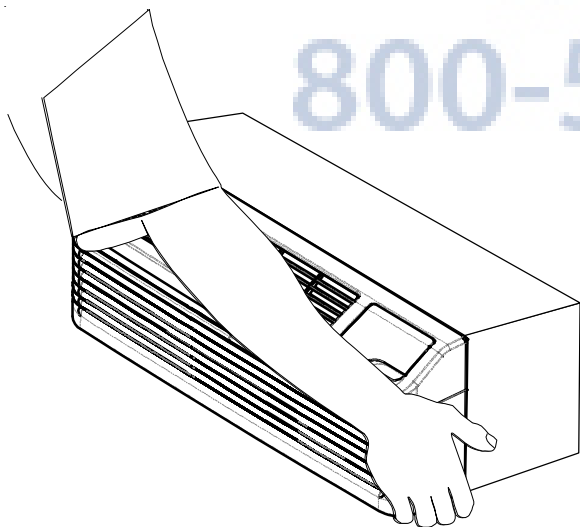

Cabinet Front Removal View 1

2. Pull the bottom of the cabinet front away from the chassis until the retaining clips disengage. **NOTE:** If front is secured with a screw, remove front mounting screw, then follow front removal procedure.

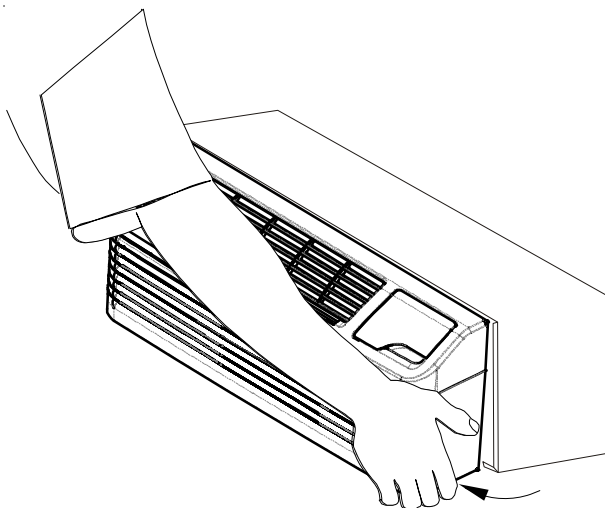

Cabinet Front Removal View 2

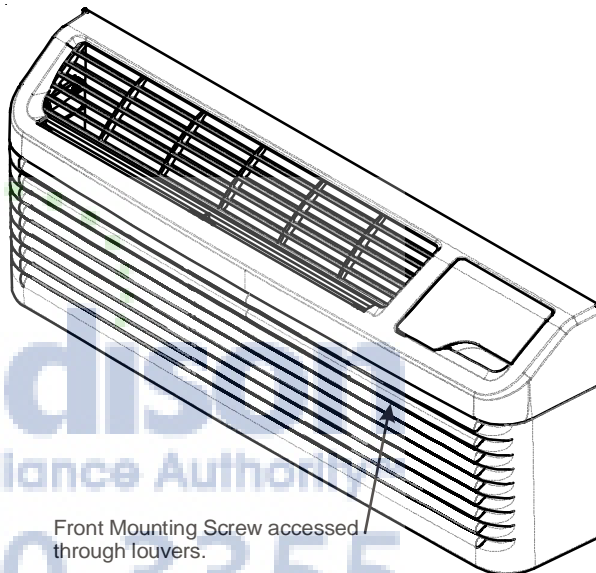

Front Mounting Screw

3. Lift the cabinet front off the chassis. Reverse this procedure to reinstall the cabinet front.

CHASSIS INSTALLATION

1. Remove the cabinet front from the chassis as described in Front Removal.
2. Insert the chassis into the wall sleeve.

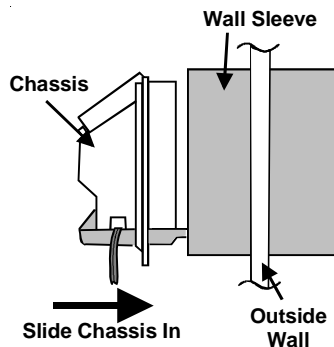

Chassis Installation View 1

- Slide the chassis into the wall sleeve until the chassis flanges contact the front edge of the wall sleeve.

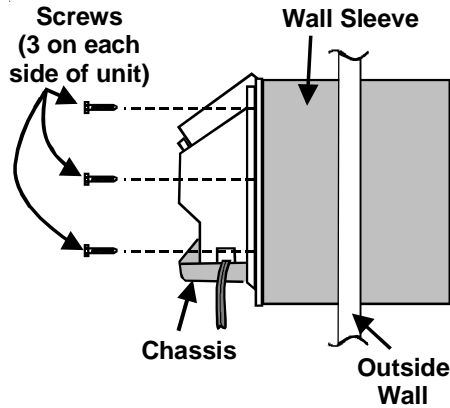



Chassis Installation View 2

- Secure the chassis to the wall sleeve using *three* screws on each side of the chassis to ensure a proper seal between the chassis and the wall sleeve. The screws are supplied in a plastic bag attached to the power cord.

IMPORTANT NOTES:

- The unit is equipped with a rubber grommet mounted compressor. These grommets are factory set and require no adjustment.
- If a standard subbase is used, be sure the right hand subbase cover is removed before the chassis is installed in the sleeve.
- On 230V, 30A units installed with an existing subbase, use the subbase cover extension kit.
- Check the indoor and outdoor grilles for obstructions to air flow. The unit must be located where curtains, furniture, trees, or other objects do not block the air flow to and from the unit. If air is obstructed and/or deflected back into the unit, the air conditioner compressor may cycle on and off rapidly. This could damage the compressor or possibly void the warranty.

WIRING

 WARNING	
<p>HIGH VOLTAGE DISCONNECT ALL POWER BEFORE SERVICING. MULTIPLE POWER SOURCES MAY BE PRESENT. FAILURE TO DO SO MAY CAUSE PROPERTY DAMAGE, PERSONAL INJURY OR DEATH. DO NOT SERVICE THIS UNIT WITHOUT FIRST SHUTTING OFF THE POWER TO THE UNIT FROM THE CIRCUIT BREAKER AND/OR REMOVING THE UNIT CORD SET PLUG FROM THE WALL OUTLET.</p>	

 CAUTION
<p>TO AVOID PROPERTY DAMAGE, PERSONAL INJURY OR DEATH DUE TO ELECTRICAL SHOCK, DO NOT USE AN EXTENSION CORD WITH THIS UNIT.</p>

 CAUTION
<p>TO AVOID THE RISK OF PROPERTY DAMAGE, PERSONAL INJURY OR FIRE, USE ONLY COPPER CONDUCTORS.</p>

 CAUTION
<p>TO AVOID THE RISK OF PROPERTY DAMAGE, PERSONAL INJURY OR FIRE, DO NOT INSTALL WITH POWER CORD STRETCHED OR UNDER A STRAIN AS THIS MAY CREATE A LOOSE PLUG/RECEPTACLE CONNECTION.</p>

 CAUTION
<p>TO AVOID THE RISK OF PERSONAL INJURY, WIRING TO THE UNIT MUST BE PROPERLY POLARIZED AND GROUNDED.</p>

Cord connection to a wall socket is not permitted for 265-volt units. All 265-volt units must be hard wired using the hard wire kit or make use of the plug-in receptacle in the standard subbase.

230/208V and 115V units are equipped with LCDI or AFCI power cords and can open the electrical circuit to the unit. In the event the unit does not operate, check the reset button located on or near the head of the power cord as part of the normal troubleshooting procedure.

 WARNING
<p>THIS AIR CONDITIONER IS NOT MEANT TO PROVIDE UNATTENDED COOLING OR LIFE SUPPORT FOR PERSONS OR ANIMALS WHO ARE UNABLE TO REACT TO THE FAILURE OF THIS PRODUCT. THE FAILURE OF AN UNATTENDED AIR CONDITIONER MAY RESULT IN EXTREME HEAT IN THE CONDITIONED SPACE CAUSING OVERHEATING OR DEATH OF PERSONS OR ANIMALS. PRECAUTIONS MUST BE TAKEN TO WARN OFF OR GUARD AGAINST SUCH AN OCCURRENCE.</p>

PTAC WIRE HARNESS KIT (PWHK01C)

See PTAC Wire Harness Kit Installation Instructions for proper wire orientation and location for low voltage wiring.

HEATERLESS UNITS

If a heaterless unit is ordered, field provisions must be made for adding supplemental heat. Refer to the Installation Instructions supplied with the kit for a complete description of the installation procedures. All 208/230 volt heaterless units are shipped with a 15 Amp power cord.

VOLTAGE MEASUREMENTS

Once the unit is properly wired, measure the unit supply voltage. Voltage must fall within the voltage utilization range given in Table 2.

Operating Voltage		
Unit Voltage Rating	Voltage Utilization Range	
	Minimum	Maximum
230/208	197	253
265	238	292
115	103.5	126.5

Table 2 - Operating Voltage

OPERATING INSTRUCTIONS

USERS CONTROLS

A 7 button touch key pad, located behind the control door, controls both temperature and operation mode. The key pads can be used alone or in combination.

THERMOSTAT SETTING

7 BUTTON TOUCH PAD WITH DISPLAY

Pressing the COOL thermostat control and the up or down arrows will provide a cooler room temperature. Pressing the HEAT thermostat control and the up or down arrow keys will provide a warmer room temperature.

LCDI OR AFCI POWER CORD

230/208V and 115V units are equipped with LCDI or AFCI power cords and can open the electrical circuit to the unit. In the event the unit does not operate, check the reset button located on or near the head of the power cord as part of the normal troubleshooting procedure.

FAN SPEED

The fan speed touch key will deliver high, low or auto fan speed to circulate room air. **NOTE:** The AUTO selection will not be available if a fan speed is selected without COOL or Heat selection.

Fan Operation HIGH or LOW with HEAT or COOL mode selected
- The selected fan speed shall run in the selected speed.

Fan Operation AUTO with HEAT or COOL mode selected - The fan will run in low and high speed. The changes in fan speed are automatic.

DIAGNOSTIC LIGHT

The green diagnostic light located in the lower left hand corner of the touchpad and indicates operation warnings. This light usually indicates that either the filter or coils need cleaning.

Please refer to the *Maintenance and Cleaning* section for the proper cleaning procedure. If this light is still on after cleaning, please refer to the *Diagnostic & Status Report* section for assistance.

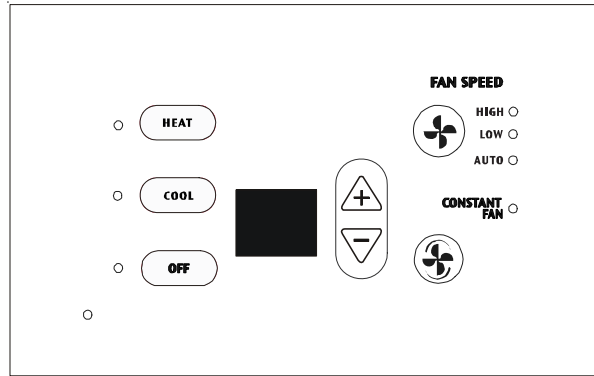

Touch Pad With Display User Controls

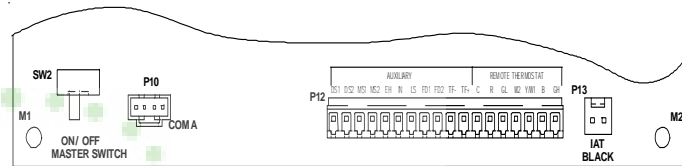

Control Board User Inputs*

*NOTE: The PTAC Wire Harness Kit (PWHK01C) is required for the auxiliary or remote thermostat options.

ADDITIONAL CONTROL INPUTS

The control inputs shown above provide additional unit control and features. To access these control inputs, the cabinet front must be removed (see Front Removal).

MASTER SWITCH

The master switch disconnects power to all of the system components. When this switch is in the off position, the compressor, fan motor, reversing valve, and electric resistance heater will all be de-energized.

⚠ WARNING

HIGH VOLTAGE
DISCONNECT ALL POWER BEFORE SERVICING.
MULTIPLE POWER SOURCES MAY BE PRESENT. FAILURE TO DO SO MAY CAUSE PROPERTY DAMAGE, PERSONAL INJURY OR DEATH.

DO NOT SERVICE THIS UNIT WITHOUT FIRST UNPLUGGING THE UNIT AT THE WALL OUTLET OR TURNING OFF THE POWER AT THE FUSE BOX OR CIRCUIT BREAKER. LINE VOLTAGE WILL BE PRESENT AT THE CONTROL BOARD, TERMINALS L1 AND L2, WHENEVER POWER IS APPLIED TO THE UNIT REGARDLESS OF THE MASTER SWITCH POSITION.

REMOTE CONTROL INPUTS

The C, R, GL, W2, Y/W1, B/O, and GH terminals provide control inputs for a "manufacturer-approved" remote wall mounted thermostat. The "B" terminal can be configured to become "O" if needed see *Configuration Settings* For remote control thermostat operation, refer to the *Remote Thermostat Operation* section.

FRONT DESK CONTROL (FD1, FD2, EH, IN)

The FD1, FD2, EH and IN terminals provide control inputs for a front desk switch. Shorting across the FD1 and FD2 terminals will disable unit operation. The only control function which will remain active when these terminals are shorted is freeze protection. Any switch which will produce a short circuit across these two terminals can be used as a front desk switch. The contact resistance of the switch, when closed, must be less than 200 ohms for the front desk feature to operate properly. Table 3 shows the maximum wire length and corresponding gage size for installation of a front desk switch. The following figure shows a wiring schematic for connecting the front desk switch to the unit.

If the unit is configured for wired unrented setback energy management (see *Configuration Settings* section c2), EH and IN terminals are used instead of FD1 and FD2. If EH and IN are shorted, the unit will go into setback temperatures for cooling and heating as configured in c3 and c4 (see *Configuration Settings*). Unit operation will be disabled. "Fd" (see *Diagnostic Codes*) will appear on the display. This allows the room to quickly recover to a comfortable temperature when the room is occupied.

Maximum Wire Length	
Wire Size (AWG)	Maximum Length Allowed
#24	400 ft
#22	600 ft
#20	900 ft
#18	1500 ft
#16	2000 ft

Table 3 - Maximum Wire Length for Front Desk Switch

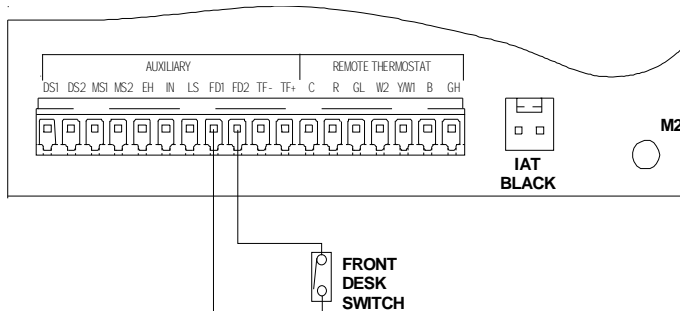

Front Desk Switch Wiring Schematic

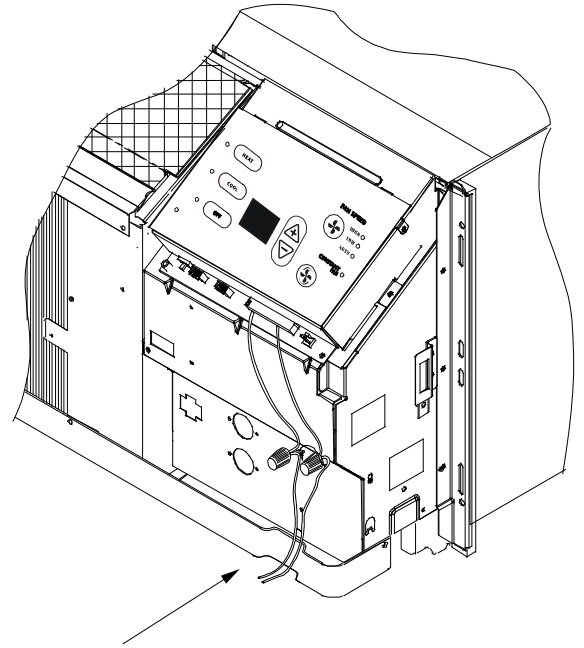

No holes are permitted in chassis basepan or wallsleeve when routing low voltage wire. Route the low voltage wires through the indentation on the front of the basepan.

Low Voltage Wires Routing

VENT CONTROL

The vent control allows outside air to be drawn into the conditioned area. This outside air can provide ventilation when the blower is operating, but it will increase the heating or cooling load and operating costs.

To obtain access to the vent control:

1. Remove the cabinet front (see Front Removal).
2. Remove the shipping screw (if installed) from the vent door.
3. Remove the label (if present) from over the vent control lever on the left side of the chassis. Remove the vent door shipping screw.

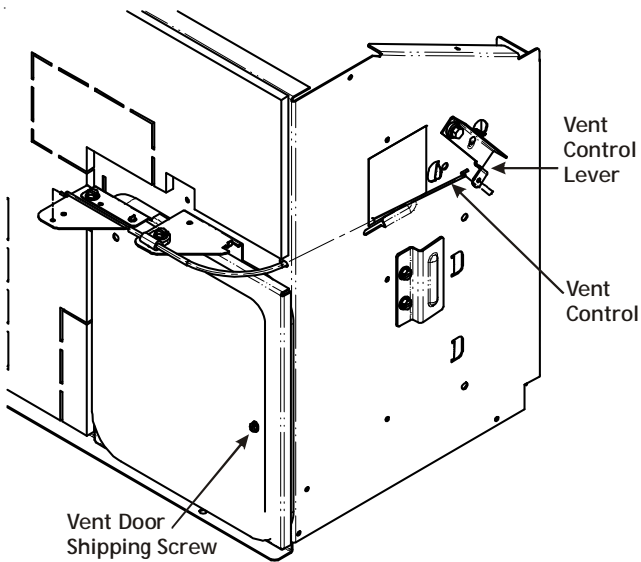

Vent Control Lever

4. Rotate the vent control lever to either open or close the damper.

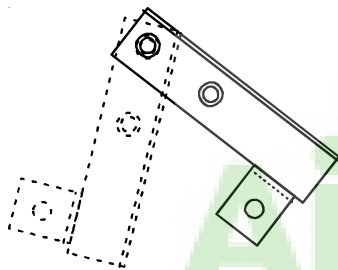

Vent Door Lever Positions

Hydronic Heat Installations

To avoid the risk of freezing the steam or water coil during prolonged shut down periods, the vent door must be left closed when the outdoor temperature might fall below freezing.

AIR DISCHARGE GRILLE

The discharge grille can be adjusted to expel air at either a 16° or 56° angle.

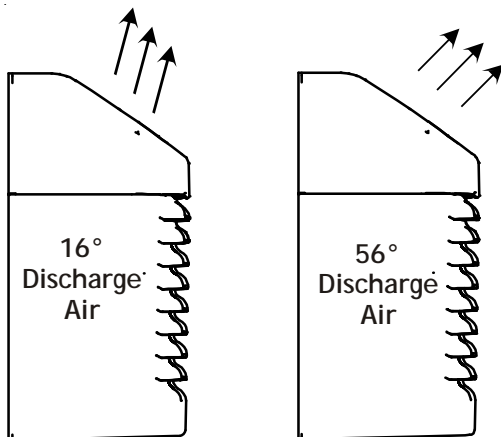

Discharge Grille Orientation Options

Use the following procedure to change the angle of the discharge air flow:

1. Remove the front cabinet (see Front Removal).
2. Position the front so that the backside is accessible.

Discharge Air Flow

3. Remove the four (4) screws which secure the discharge air grille to the cabinet front.

Location of 4 Screws

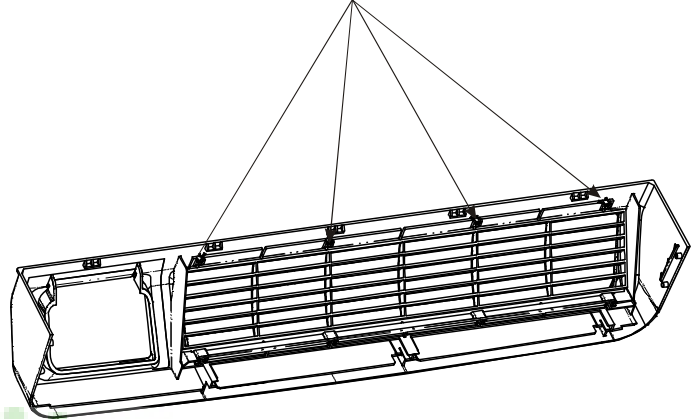

Discharge Air Flow Grille Removal

4. Rotate the grille 180° clockwise.
5. Reinstall the screws securing the discharge air grille to the cabinet front. Reinstall the cabinet front on the unit.

REMOTE THERMOSTAT

To operate this unit with a "manufacturer-approved" remote thermostat, configure the control to be operated by the remote thermostat. Enter configuration mode C1 and then select option Code L5 (see Configuration Settings in back of manual). When in the remote mode, the unit will only respond to the thermostat inputs (terminal strip positions GL (or GH), W2, Y/W1, and B* shown in "Control Board User Inputs" illustration). **NOTE:** Once configuration C1 with option code L5 has been selected, the control touchpad will no longer accept inputs other than configuration and diagnostics modes. The room occupant must operate the unit at the remote mounted thermostat.

NOTE: In remote mode, the 3-minute compressor time delay, the random restart feature and the freeze protection feature are all active (see *Unit Features* section).

THERMOSTAT LOCATION

This unit is designed to be operated with remote wall mounted thermostats. For further information on thermostats approved for use with this unit, contact your sales representative.

For best performance results, the thermostat should be located approximately five feet above the floor on a vibration free, inside wall in an area with good air circulation.

Do not install the thermostat where it may be affected by the following:

- Dead spots behind doors, in corners or under cabinets
- Hot or cold drafts from air ducts
- Radiant heat from the sun, appliances, or fireplaces
- Concealed pipes and chimneys
- Unheated (uncooled) areas behind the thermostat, such as an outside walls

Consult the instruction sheet packaged with the thermostat for further details on mounting and operation.

REMOTE THERMOSTAT OPERATION

Approved thermostats vary slightly in construction and, with few exceptions, are operated similarly. The following operational description pertains to approved nonprogrammable thermostats that energize G in Heat and Cool mode.

HEAT/OFF/COOL Switch

- OFF - cooling and heating functions are defeated.
- HEAT - the selected room temperature is maintained by cycling either in the heat pump mode or electric strip heat. A PTH unit is switched from the heat pump mode to electric strip heat when the coil temperature is 20°F or when the heat pump cannot keep up with the heating load and a two stage thermostat is used.
- COOL - the selected room temperature is maintained by cycling the air conditioner.

Table 4 summarizes the thermostat input combinations and the respective unit functions. The following wiring schematic illustrations show wiring schematics for heat pump and straight cool units with electric resistance heat, respectively.

Unit Function	Heat Pump Thermostat Input		Electric Heat Thermostat Input	
	R Terminal to:		R Terminal to:	
OFF	NONE		NONE	
HEAT	Stage 1	GL*, Y/W1, B**, O	GL* Y/W1, B**, or GL*, W2, O	
	Stage 2	GL*, W2	n/a	
COOL	GL*, Y/W1, B**, O		GL*, Y/W1	

*or GH depending on speed required

**If configured, B and O can be used interchangeably.

Table 4 - Remote Control Inputs

NOTE: The PTAC Wire Harness Kit (PWHK01C) is required for remote thermostat options.

ADDITIONAL NOTES:

1. For heat pump operation, a room thermostat with a B (heating change over) terminal or an O terminal (cooling change over) is required. This will mean that some “auto changeover” thermostats cannot be used, as many of them either do not have a B terminal, or else energize the B terminal continuously when in the “auto” position.
2. Additional wiring should be run for future changeover to Heat Pump or thermostat options.
3. Run 6 to 8 wires during initial installation. Tape or cap off any unused wires.

NOTE: Using a thermostat with an O terminal will require that the 7 button with display control be configured (see Configuration Settings).

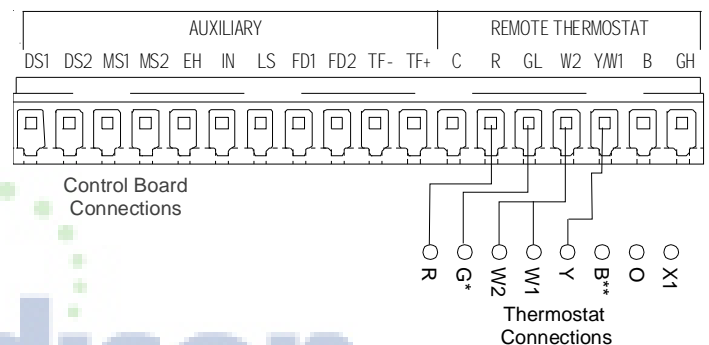

Wiring Schematic for Straight Cool Unit

*NOTE: For high speed fan operation, connect “G” to “GH”.

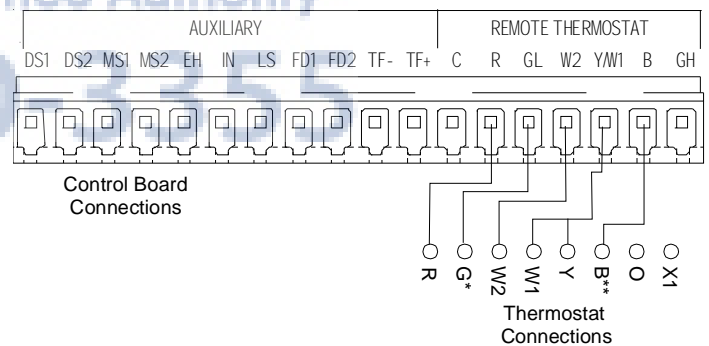

Wiring Schematic for Remote Heat Pump

*NOTE: For high speed fan operation, connect “G” to “GH”.

Table 5 shows the maximum wire length and corresponding gage size for installation of a remote thermostat.

NOTE: If configured, B and O input terminals can be used interchangeably.

Maximum Wire Length	
Wire Size (AWG)	Maximum Length Allowed
#24	400 ft
#22	600 ft
#20	900 ft
#18	1500 ft
#16	2000 ft

Table 5 - Maximum Wire Length for Remote Control Connection

1. Grasp each filter by its molded handle, located on the front edge of the front, below the discharge grill.
 2. Pull the filter straight up and remove.
 3. Clean filter with vacuum or with running water.
- Reverse this procedure to reinstall the filters.

WARNING

HIGH VOLTAGE
DISCONNECT ALL POWER BEFORE CLEANING THIS UNIT. MULTIPLE POWER SOURCES MAY BE PRESENT. FAILURE TO DO SO MAY CAUSE PROPERTY DAMAGE, PERSONAL INJURY OR DEATH.



Filters are removed by grasping the filter's top and gently pulling up

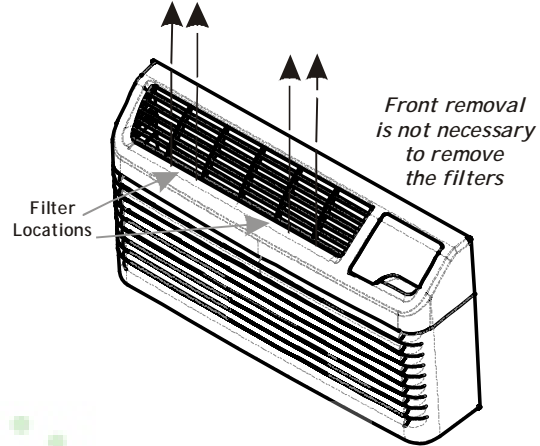

MAINTENANCE AND CLEANING

WARNING

HIGH VOLTAGE
TO AVOID PROPERTY DAMAGE, PERSONAL INJURY OR DEATH DUE TO ELECTRICAL SHOCK, CLEAN AIR FILTERS AND COILS REGULARLY. CLOGGED OR SEVERELY RESTRICTED FILTERS OR COILS REDUCE AIRFLOW, WHICH CAN CAUSE DRASTIC EFFICIENCY LOSS AS WELL AS SEVERE COMPONENT DAMAGE TO COMPRESSORS, ELECTRIC HEATER OR FAN MOTOR. IN EXTREME CASES, CLOGGED FILTERS AND/OR COILS MAY CREATE A FIRE HAZARD AND WILL VOID THE WARRANTY



Intake Filter Removal

Vent Screen

Before cleaning the vent screen, disconnect power to the unit by unplugging the power cord at the wall outlet or subbase, or disconnect power at the fuse box or circuit breaker. If unit is operated with vent door closed, the vent screen does not need to be cleaned.

1. Remove the cabinet front as described in Front Removal.
2. Remove the six screws securing the chassis to the wall sleeve.
3. Slide the chassis out of the wall sleeve far enough so that the vent screen is accessible.
4. Clean the vent screen, slide the chassis back into the wall sleeve, secure it in place with six screws and reinstall the front cabinet.

WARNING

SOME LOCAL CONDITIONS AND ENVIRONMENTS CAN CAUSE FUNGI AND OTHER MATERIAL TO GROW INSIDE THE PTAC UNIT. THIS MATERIAL WHEN DRIED, AS WELL AS OTHER FOREIGN MATERIAL, SIMILAR TO DRYER LINT IN YOUR CLOTHES DRYER, ARE FIRE HAZARDS. BE SURE TO THOROUGHLY CHECK AND CLEAN THE UNIT'S COILS, BLOWER WHEEL AND BASEPAN PER THE INSTRUCTIONS CONTAINED IN THIS MANUAL.

MONTHLY MAINTENANCE AND CLEANING

Intake Air Filters

To properly maintain the operational performance of your PTAC unit, it is extremely important that the inlet air filters be cleaned once per month or more often if operated in dusty or dirty locations or conditions. The intake air filters are constructed of durable polypropylene. The "air intake" air filters can be easily inserted into the cabinet front using the cabinet filter guides. Before cleaning the intake filter, turn the unit off by setting the mode switch to the OFF position. Filter should be cleaned as required.

The following procedure is used to remove the intake filters:

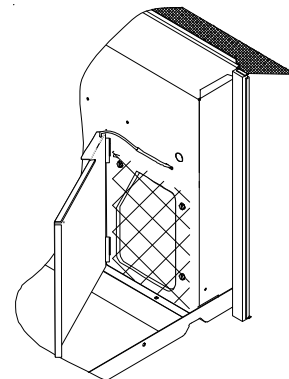

Vent - (Left Side Unit)

Cabinet Front

The cabinet front and discharge air grille can be cleaned with a water dampened cloth. Under no circumstances should hydrocarbon-based cleaners (e.g. acetone, benzene, naphtha gasoline, etc.) or ammonia based cleaners be used to clean the front or air grilles. Use care when cleaning the control area.

YEARLY MAINTENANCE AND CLEANING

NOTE: Use a mild biodegradable detergent such as Simple Green™ when cleaning the unit. Special care must be taken to protect the unit's control board and other electrical components from getting any water on them while cleaning. The use of harsh or caustic cleaning agents or materials such as bleach or coil cleaners that are not designed for PTAC products will cause damage or deterioration of the aluminum fin or coil material and is not recommended. Care must be taken not to bend the aluminum fin stock.

Routine Scheduled Maintenance

To achieve continuing top performance and high efficiency, establish a "once a year" cleaning/inspection schedule for the unit. Take the unit out of the sleeve and thoroughly clean and rinse. Be sure to include in the yearly cleaning the evaporator coils, and condenser coils, basepan, and drain passages. Scheduled maintenance can be accomplished by either qualified local maintenance staff or by an authorized servicer. They must follow the instructions described in this manual.

Adverse Operating Conditions Maintenance

Units operating in dusty or corrosive locations; i.e. dusty construction site or sea coast, must be cleaned more often. A minimum of four (4) times a year will maintain proper operational conditions and protect unit components.

Wall Sleeve

Clean the wall sleeve while cleaning the unit. The caulking around the sleeve should be checked to make sure that any potential air and water openings around the sleeve are properly sealed. The wall sleeve's level should also be rechecked. Proper leveling for most installations are a ¼ bubble tilt to the outside and level from right to left. Contact your sales person for detailed maintenance or cleaning instructions.

Basepan and Condenser Coil



DO NOT USE COMMERCIAL GRADE COIL CLEANERS. SOME OF THESE CLEANERS MAY CONTAIN ETHYLENE DIAMINE TETRACETIC ACID (EDTA) WHICH CAN SHORTEN THE LIFE OF THE CONDENSER COIL.

Before cleaning the basepan and condenser coil, turn OFF unit mode switch and disconnect power to the unit. To disconnect power, either unplug the power cord at the wall outlet or subbase, or disconnect power at the fuse box or circuit breaker.

1. Create a water-tight seal by tightly covering the entire control panel area and fan motor with plastic. Creating this seal prevents water from entering the control area or the fan motor and damaging the unit.
2. Spray condenser coil and basepan down with water. Next spray a mild biodegradable detergent such as Simple Green™ onto the condenser coil and basepan. Let set for five (5) minutes.
3. Rinse condenser coil and basepan with water again.
NOTE: Ensure water pressure is no higher than that of an ordinary garden hose and the water temperature no higher than 120°F.
4. Tilt the non-compressor side of the unit up no higher than 45 degrees and allow water to drain out the other side of the unit.
5. Remove excess water left in the basepan by wiping the basepan with a dry cloth.
6. Remove the water-tight seal from the motor and control panel area.
7. Reinstall unit back into wall sleeve.
8. Allow unit to dry for 24 hours before reapplying power. When power is reapplied test unit for proper operation.
9. Place a non-acidic algaecide in the basepan to inhibit bacteria growth. Ensure the algaecide is compatible with wet coil operation and is not corrosive to the coil.



CAUTION

HIGH PRESSURE AND HIGH TEMPERATURE CLEANING IS NOT RECOMMENDED. DOING SO COULD DAMAGE THE ALUMINUM FIN STOCK AND ELECTRICAL COMPONENTS.

Clearance Check

Clearances around the unit should also be checked to make sure that the intake air and discharge air paths have not become blocked or restricted. A minimum of eight inches clearance is needed from unit to furniture, beds, or other objects for proper operation. Restricted discharge or intake air will reduce the unit's operational performance. In severe airflow restrictions damage can occur to unit components such as the compressor, electric heater or fan motor.

OBTAINING SERVICE

In the event this unit requires repair or servicing beyond what is covered in this manual, contact an authorized service organization.

To obtain an authorized servicer, contact your sales representative or agency.

NORMAL OPERATING SOUNDS AND CONDITIONS

Water trickling sounds

Water is picked up and distributed over the coil. This improves the efficiency and helps with water removal.

Water dripping

Water will collect in the base pan during high humidity days. This can cause overflow and drip from the outside of the unit.

Air sounds

The fan cycle switch sets the operational mode of the fan in the ON position. The fan will run continuously whenever power is applied in this mode. In the AUTO position, the fan will cycle on and off with the compressor or electric heater.

Starting delay





You may notice a few minutes delay in the starting if you try to restart the unit too soon after turning it off or if you adjust the thermostat right after the compressor has shut off. This is due to a built in delay to protect the compressor.



CONFIGURATION SETTINGS

7 BUTTON TOUCH PAD WITH DISPLAY

The control can be configured to operate a wide range of options. The options listed below with the * are the factory default settings. If these are acceptable, then the unit does not require any additional configuration and is fully operable. To configure the unit, first select the configuration feature code setting and then an option code to change from the factory default setting.

To enter configuration feature mode:

1. Press and hold the up and down  arrow keys at the same time and press the OFF  key twice within a two (2) second time frame. The display will indicate - -., and then release the  key and press the  key one time. The display will then alternate between C1 and 0.

To select a different configuration feature code, press the HEAT  key until the desired configuration comes up. To scroll to a previously viewed configuration codes press the COOL  key. Once you have scrolled to the correct feature, then to select the option code for your desired configuration, press either the up or down key  to scroll through the options of the selected feature code.

To exit configuration mode:

1. Press the OFF  key. Configuration feature mode will also exit if no keys are pressed for a period of two (2) minutes.

CONFIGURATION SETTINGS CHART

Configuration Code	Description	Option Code	Description
C1	Interface	0*	Chassis Membrane*
		rE	Wireless Remote
		L5	Wired Thermostat
C2	Fan Operation	bP	Button present
		bA*	7-Button, reverts to Cyclic
		A	Always run fan (even in Off)
		bC	7-Button, reverts to Continuous
C3	Reverse Cycle Operation	C	Cooler Only
		H*	Heat Pump*
		0	Service No Operation "Eo"
C4	Room I.D. Digit 1 & 2	00* - 99	00* - 99
C5	Room I.D. Digit 3 & 4	00* - 99	00* - 99
C6	Wired or Wireless Occupancy	0*	Off*
		1	On
		18	18 Hour Automatic Entry
C8	Temp. Limiting Cool	60* - 72	60* - 72
C9	Temp. Limiting Heat	68 - 90, 80*	68 - 90, 80*
Cd	English / Metric Temp	F*	Fahrenheit Scale*
		C	Celsius Scale
d6	Sensorless Un-Occ. Time	1 - 32, 18*	1 - 32, 18*
d7	1st Un-Occ. Set Back Temp.	1 - 16, 2*	1 - 16, 2*
d8	1st Un-Occ. Set Back Time	.1, .5*, 1 - 24	.1, .5, 1 - 24, .5*
d9	2nd Un-Occ. Set Back Temp.	1 - 16, 3*	1 - 16, 3*
dA	2nd Un-Occ. Set Back Time	.1, .5, 1* - 24	(d8) - 24, 1*
db	3rd Un-Occ. Set Back Temp.	1 - 16, 6*	1 - 16, 6*
dC	3rd Un-Occ. Set Back Time	.1, .5, 1 - 24, 3*	(dA) - 24, 3*
dF	Jace Group Code	00* - 99	00* - 99
r4	Room Prefix	00* - 99	00* - 99
r5	Room Suffix	00* - 99	00* - 99



*Indicates factory default

See manufacturer for additional configuration options.

DIAGNOSTIC MAINTENANCE & STATUS REPORT

The Diagnostic Maintenance & Status Report provides detailed information on PTAC control operation and operational status including present modes, failures, airflow restriction warnings, operating temperatures, and past failures. The lower right hand dot on the center display flashes in this mode. In some cases the green LED located in the lower left hand corner of the touchpad below the OFF key will also be lit. This Green LED "Status Light" only illuminates if there is a status code that has been activated and should be reviewed. In most cases, this light indicates that the indoor room filter is dirty should be cleaned or replaced. **NOTE:** Dirty filters cause the unit to consume more energy than normally needed to condition a room. Once the filter has been cleaned or replaced, the LED should go out. If the LED is still illuminated after the filter has been cleaned, activate the Diagnostic and Status mode to view any active codes. The unit may need additional cleaning or maintenance of the evaporator or condenser coils. Please perform this step before calling a servicer. A servicer should be called only if cleaning the filter or coils does not clear the status code or the code indicates that servicer should be called.



DIAGNOSTIC STATUS REPORT MODE.

To enter Diagnostic Status Report mode, press and hold the up and down  arrows and, while holding, quickly press the COOL key  twice.



ACTIVE FAILURES.

- If there are no active failures or lockouts, the display will show a double dash, "- -". If there is a code listed, see the unit "Diagnostic Codes" chart for a list of definitions.

OPERATING TEMPERATURES.

- If not in Diagnostic Status Report Mode, enter as instructed above and press the Fan Speed  key.
- If already in Diagnostic Status Report mode, press the Fan Speed  key. The display will show the temperature of the desired set point, SP; the temperature at the wireless thermostat, rL; the indoor ambient temperature behind the filter, IA; the indoor coil temperature, IC; the indoor discharge air temperature, Id; the outdoor coil temperature, OC; the outdoor ambient temperature, OA; and the spare probe temperature, IH. If any of the probes are not populated the display will show the corresponding failure code.

PAST FAILURE LOG

- If not in Diagnostic Status Report Mode, enter as instructed above and press the Fan Speed  key twice.
- If already in Diagnostic Status Report mode, press the Fan Speed  key. While the display is showing operating temperatures, the last 10 failure codes active or past can be requested by pressing the Fan Speed  key again. The codes are displayed last entry first followed subsequently by each preceding code.

Note that modes F1 and Fd are also displayed in the normal control operation (see "Diagnostic Codes" chart).

To exit Diagnostic Status Report mode, press the OFF  key.

DIAGNOSTIC CODES

CODE	STATUS	DISPLAY	ERROR LIGHT	SUGGESTED ACTION	
MODES	FP	Freeze Protection Engaged. The room temperature measured by the wireless remote thermostat or indoor ambient thermistor active sensor falls below 40°F.	Y	N	No Action required. This setting will disengage when the room temperature rises above 43°F.
	Fd	Front Desk switch is closed. All outputs are switched off.	Y	N	Open front desk switch to allow occupant unit operation.
	Eo	Un-Configured Service Board - All operation held awaiting configuration	Y	Y	Enter Configuration Menu and set "C3" to "C" for coolers with electric heat or "H" for heat pumps.
	EH	Emergency Hydronic Engaged. The EHH switch is closed. Compressor is switched off.	Y	N	Open front emergency hydronic switch to allow occupant unit operation.
	LS	Load Shedding Engaged. The LS switch is closed. Compressor and Electric heat is switched off.	Y	N	Open load shedding switch to allow occupant unit operation.
	On	Control is configured to respond to a wired thermostat	Y	N	No action if a wired thermostat is being used. Otherwise, see Configuration Settings.
	oP	Open Door Lockout (DS1 & DS2 open; wireless)	Y	Y	Close Room Door. Unit will not condition space with door open.
	nP	Window Switch Lockout - (LS & INN open)	Y	Y	Close Room Door or Window. Unit will not condition space with door or window open.
	hP	Heat Sentinel - (WIAT > u3)	Y	N	No action required. This setting will disengage when the room temperature falls.
	Ur	Un-Rented Status (EHH & INN or wireless)	Y	N	Front Desk needs to set to Rented mode (if applicable).
FAILURES	F1	Indoor Ambient Thermistor reads outside the range -20°F to 200°F & the wireless thermostat is not communicating to the unit control or Indoor Ambient Thermistor (IAT) without a wireless remote thermostat reads outside the range -20°F to 200°F.	Y	Y	Replace black Indoor Ambient Thermistor or Wireless Remote Thermostat.
	F2	Wireless Remote Thermostat failure	N	N	Replace Wireless Thermostat.
	F3	Indoor Ambient Thermistor reads outside the range -20°F to 200°F	Y	N	Replace black Indoor Ambient Thermistor.
	F4	Indoor Coil Thermistor either above or below operating tolerances.	N	Y	Replace Red Indoor Coil Thermistor .
	F5	Wireless Thermostat failure.	N	Y	Attempt to rebind Wireless Thermostat or Replace Wireless Thermostat.
	F6	Indoor Discharge Thermistor either above or below operating tolerances.	N	Y	Replace Yellow Indoor Discharge Thermistor.
	Fb	Low Remote Battery Warning.	N	Y	Replace Batteries in Wireless Devices.
	H1	High Voltage Protection engaged. Power supply voltage is to high.	Y	N	Check for incoming power at correct voltage.
br	Brown Out Protection engaged. Power was lost or voltage is low.	N	N	Check for incoming power at correct voltage.	
AIRFLOW ALERTS	L6	Discharge Air Too Hot.	N	Y	Clean Filter or Remove Air Blockage.
	LC	Outdoor Coil Thermistor temperature high.	N	Y	Clean Condenser Coils, Check Fan for fault. Code will reset after cleaning.
	C2	Indoor Air Recirculation. Large delta between thermostat and return.	N	Y	Clean Filter or Remove Air Blockage or Close Vent Door or Improve indoor to outdoor seal.
	C5	Outdoor Coil temperature too high for outdoor ambient temperature.	N	Y	Check for Blocked Outdoor Air or Clean Coil.
REFRIGERATION ALERTS	C1	Indoor Coil is freezing up.	N	Y	Clean filter, Check for fan and blower operation, Check for Refrigerant loss or Restricted capillary tube.
	C3	Indoor Coil is freezing up.	N	Y	Clean filter, Check for fan and blower operation, Check for Refrigerant loss or Restricted capillary tube.
	C4	Indoor Coil froze up.	N	Y	Clean filter, Check for fan and blower operation, Check for Refrigerant loss or Restricted capillary tube.
	C6	Poor Unit Performance.	N	Y	Check for blower motor, compressor, or electric heat operation.
	C7	Indoor Freezing Lockout (ICT - IAT > 20) +10 Min	N	Y	Clean filter, Check for fan and blower operation, Check for Refrigerant loss or Restricted capillary tube.

THIS PAGE INTENTIONALLY LEFT BLANK



THIS PAGE INTENTIONALLY LEFT BLANK



**Aj Madison**
Your Appliance Authority™
800-570-3355



Amana^{Heating & Air Conditioning}

is a registered trademark of Maytag Corporation or its related companies and is used under license to Goodman Company, L.P., Houston, TX. All rights reserved.

5151 San Felipe, Suite 500 • Houston, TX 77056 • www.amana-ptac.com

© 2009, 2011 Goodman Company, L.P.