

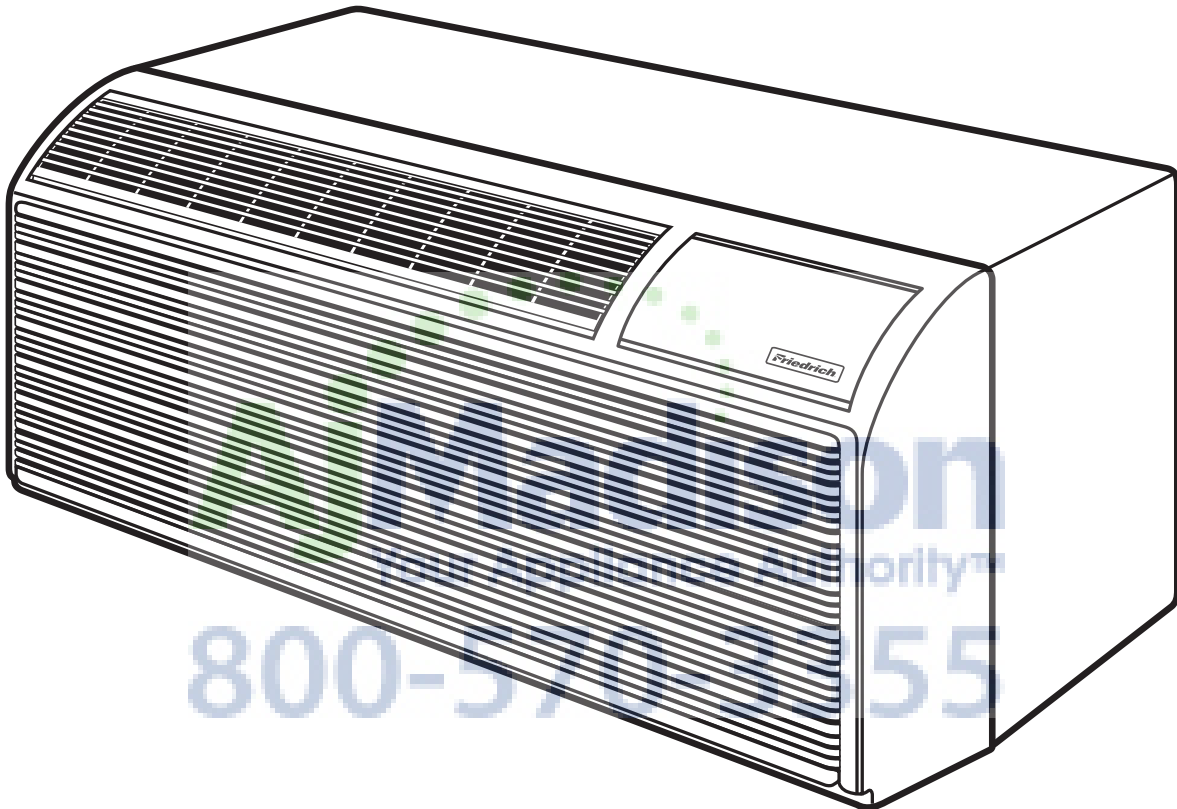

F R I E D R I C H

Service Manual – R410A Models



PTAC - PD Series (Electronic Controls)

Packaged Terminal Air Conditioners

Packaged Terminal Heat Pumps

TECHNICAL SUPPORT CONTACT INFORMATION



F R I E D R I C H

FRIEDRICH AIR CONDITIONING CO.

Post Office Box 1540 · San Antonio, Texas 78295-1540
4200 N. Pan Am Expressway · San Antonio, Texas 78218-5212
(210) 357-4400 · 1-800-541-6645 · FAX (210) 357-4490
www.friedrich.com

Printed in the U.S.A.

Table of Contents

Important Safety Information	2-4	Capillary Tube Systems/Check Valve	23
Introduction	4	Reversing Valve — Description/Operation	24
Unit Identification	5	Testing Coil	24
Component Identification	6	Checking Reversing Valves	24-25
Chassis Specifications	7	Reversing Valve	
Performance Data	8	Touch Testing Heating/Cooling Cycle	25
Electrical Rating Tables	9	Procedure For Changing Reversing Valve	25-26
Power Cord Information	9	Compressor Checks	26
Remote Wall Thermostat / Low Voltage		Locked Rotor Voltage Test	26
Wire Connections	10	Single Phase Connections	26
Digital Control Features	11-12	Determine Locked Rotor Voltage	26
Digital Control Operation	13	Locked Rotor Amperage Test	26
Digital Control User Input Configuration	14	Single Phase Running & Locked Rotor Amperage	28
Optional Hand Held Remote Control Operation	15	Checking the Overload	26-27
Digital Control Diagnostics & Test Mode	15	External Overload	27
Electronic Control Error Code Diagnostics	16	Compressor Single Phase Resistance Test	27
Components Testing	17-18	Compressor Replacement	28-29
Refrigeration System Sequence of Operation	19	Routine Maintenance	29
Sealed Refrigeration System Repairs	20	Troubleshooting Charts	30-31
Refrigerant Charging	20	Wiring Diagram Index	32
Method Of Charging	21	Wiring Diagrams for Cool with Electric Heat	33
Undercharged Refrigerant Systems	21-22	Wiring Diagrams for Heat Pump with Electric Heat	34
Overcharged Refrigerant Systems	22	Remote Thermostat Wiring Diagram	35
Restricted Refrigerant Systems	22	Technical Service Data	36

IMPORTANT SAFETY INFORMATION

The information contained in this manual is intended for use by a qualified service technician who is familiar with the safety procedures required for installation and repair, and who is equipped with the proper tools and test instruments required to service this product.

Installation or repairs made by unqualified persons can result in subjecting the unqualified person making such repairs as well as the persons being served by the equipment to hazards resulting in injury or electrical shock which can be serious or even fatal.

Safety warnings have been placed throughout this manual to alert you to potential hazards that may be encountered. If you install or perform service on equipment, it is your responsibility to read and obey these warnings to guard against any bodily injury or property damage which may result to you or others.

Your safety and the safety of others are very important.

We have provided many important safety messages in this manual and on your appliance. Always read and obey all safety messages.



This is a safety Alert symbol.

This symbol alerts you to potential hazards that can kill or hurt you and others.

All safety messages will follow the safety alert symbol with the word "WARNING" or "CAUTION". These words mean:



You can be killed or seriously injured if you do not follow instructions.



You can receive minor or moderate injury if you do not follow instructions.

All safety messages will tell you what the potential hazard is, tell you how to reduce the chance of injury, and tell you what will happen if the instructions are not followed.



A message to alert you of potential property damage will have the word "NOTICE". Potential property damage can occur if instructions are not followed.

PERSONAL INJURY OR DEATH HAZARDS

ELECTRICAL HAZARDS:

- Unplug and/or disconnect all electrical power to the unit before performing inspections, maintenance, or service.
- Make sure to follow proper lockout/tag out procedures.
- Always work in the company of a qualified assistant if possible.
- Capacitors, even when disconnected from the electrical power source, retain an electrical charge potential capable of causing electric shock or electrocution.
- Handle, discharge, and test capacitors according to safe, established, standards, and approved procedures.
- Extreme care, proper judgment, and safety procedures must be exercised if it becomes necessary to test or troubleshoot equipment with the power on to the unit.
- Do not spray or pour water on the return air grille, discharge air grille, evaporator coil, control panel, and sleeve on the room side of the air conditioning unit while cleaning.
- Electrical component malfunction caused by water could result in electric shock or other electrically unsafe conditions when the power is restored and the unit is turned on, even after the exterior is dry.
- Never operate the A/C unit with wet hands.
- Use air conditioner on a single dedicated circuit within the specified amperage rating.
- Use on a properly grounded outlet only.
- Do not remove ground prong of plug.
- Do not cut or modify the power supply cord.
- Do not use extension cords with the unit.
- Follow all safety precautions and use proper and adequate protective safety aids such as: gloves, goggles, clothing, adequately insulated tools, and testing equipment etc.
- Failure to follow proper safety procedures and/or these warnings can result in serious injury or death.

REFRIGERATION SYSTEM HAZARDS:

- Use approved standard refrigerant recovering procedures and equipment to relieve pressure before opening system for repair.
- Do not allow liquid refrigerant to contact skin. Direct contact with liquid refrigerant can result in minor to moderate injury.
- Be extremely careful when using an oxy-acetylene torch. Direct contact with the torch's flame or hot surfaces can cause serious burns.
- Make sure to protect personal and surrounding property with fire proof materials.
- Have a fire extinguisher at hand while using a torch.
- Provide adequate ventilation to vent off toxic fumes, and work with a qualified assistant whenever possible.
- Always use a pressure regulator when using dry nitrogen to test the sealed refrigeration system for leaks, flushing etc.

- Make sure to follow all safety precautions and to use proper protective safety aids such as: gloves, safety glasses, clothing etc.
- Failure to follow proper safety procedures and/or these warnings can result in serious injury or death.

MECHANICAL HAZARDS:

- Extreme care, proper judgment and all safety procedures must be followed when testing, troubleshooting, handling, or working around unit with moving and/or rotating parts.
- Be careful when, handling and working around exposed edges and corners of sleeve, chassis, and other unit components especially the sharp fins of the indoor and outdoor coils.
- Use proper and adequate protective aids such as: gloves, clothing, safety glasses etc.
- Failure to follow proper safety procedures and/or these warnings can result in serious injury or death.

PROPERTY DAMAGE HAZARDS

FIRE DAMAGE HAZARDS:

- Read the Installation/Operation Manual for this air conditioning unit prior to operating.
- Use air conditioner on a single dedicated circuit within the specified amperage rating.
- Connect to a properly grounded outlet only.
- Do not remove ground prong of plug.
- Do not cut or modify the power supply cord.
- Do not use extension cords with the unit.
- Failure to follow these instructions can result in fire and minor to serious property damage.

WATER DAMAGE HAZARDS:

- Improper installation maintenance, or servicing of the air conditioner unit, or not following the above Safety Warnings can result in water damage to personal items or property.
- Insure that the unit has a sufficient pitch to the outside to allow water to drain from the unit.
- Do not drill holes in the bottom of the drain pan or the underside of the unit.
- Failure to follow these instructions can result in result in damage to the unit and/or minor to serious property damage.

INTRODUCTION

This service manual is designed to be used in conjunction with the installation manuals provided with each unit.

This service manual was written to assist the professional HVAC service technician to quickly and accurately diagnose and repair any malfunctions of this product.

This manual, therefore, will deal with all subjects in a general nature. (i.e. All text will pertain to all models).

IMPORTANT: It will be necessary for you to accurately identify the unit you are servicing, so you can be certain of a proper diagnosis and repair. (See Unit Identification.)

UNIT IDENTIFICATION

Model Number Code

PD H 07 K 3 S E A

Series
PD = P Series Digital PTAC

Engineering Digit

Design Series

System
E = Cooling with or without electric heat
H = Heat Pump with Auxiliary Heat

Options
S = Standard

Nominal Cooling Capacity
07 = 7000 BTUh
09 = 9000 BTUh
12 = 12000 BTUh
15 = 15000 BTUh

Nominal Heater Size
(@ 230V or 265V)
0 = No Heater
2 = 2.5KW
3 = 3.4KW
5 = 5.0KW

Voltage
K = 208/230V - 1Ph. - 60Hz.
R = 265V - 1Ph. - 60Hz.

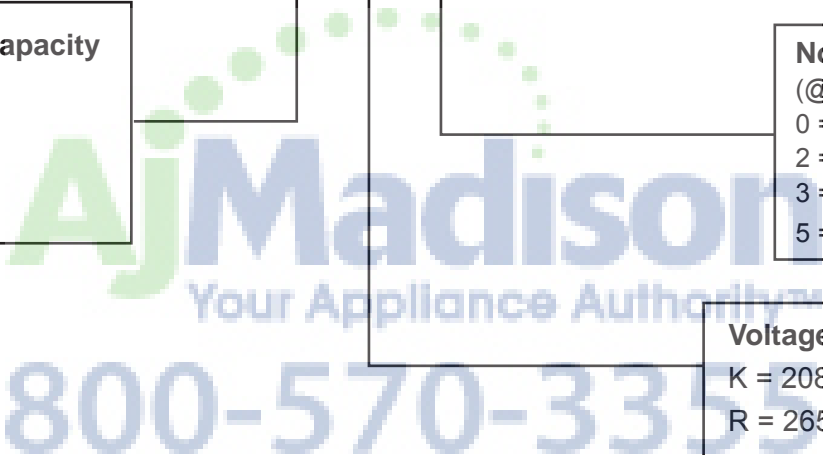

PTAC Serial Number Identification Guide

SERIAL NUMBER	A	K	A	M	00001
YEAR MANUFACTURED LJ = 2009 AE = 2015 AK = 2010 AF = 2016 AA = 2011 AG = 2017 AB = 2012 AH = 2018 AC = 2013 AJ = 2019 AD = 2014					PRODUCTION RUN NUMBER
					PRODUCT LINE M = PTAC
MONTH MANUFACTURED A = Jan D = Apr G = Jul K = Oct B = Feb E = May H = Aug L = Nov C = Mar F = Jun J = Sep M = Dec					

Component Identification



Your Appliance Authority

 800-570-3355

ELECTRIC HEAT DATA											
	PDE/PDH07K		PDE/PDH07R		PDE09K0	PDE/PDH09K			PDE/PDH09R		
HEATER WATTS	2500/2050	3400/2780	2500	3400	0 Kw	2500/2050	3400/2780	5000/4090	2500	3400	5000
VOLTAGE	230/208		265			230/208			265		
HEATING BTUh	8500/7000	11600/9500	8500	11600	0	8500/7000	11600/9500	17000/13900	8500	11600	17000
HEATING CURRENT (AMPS)	11.4/10.4	15.3/13.9	9.8	13.2	0	11.4/10.4	15.3/13.9	22.3/20.3	9.8	13.2	19.5
MINIMUM CIRCUIT AMPACITY	14.1	19.0	12.2	16.4	0.0	14.1	19	27.8	12.2	16.4	24.2
BRANCH CIRCUIT FUSE (AMPS)	15	20	15	20	15	15	20	30	15	20	30

ELECTRIC HEAT DATA														
	PDE12K0	PDE/PDH12K			PDE/PDH12R			PDE15K0	PDE/PDH15K			PDE/PDH15R		
HEATER WATTS	0 Kw	2500/2050	3400/2780	5000/4090	2500	3400	5000	0 Kw	2500/2050	3400/2780	5000/4090	2500	3400	5000
VOLTAGE		230/208			265				230/208			265		
HEATING BTUh	0	8500/7000	11600/9500	17000/13900	8500	11600	17000	0	8500/7000	11600/9500	17000/13900	8500	11600	17000
HEATING CURRENT (AMPS)	0	11.4/10.4	15.3/13.9	22.3/20.3	9.8	13.2	19.5	0	11.4/10.4	15.3/13.9	22.3/20.3	9.8	13.2	19.5
MINIMUM CIRCUIT AMPACITY	0	14.1	19	27.8	12.2	16.4	24.2	0	14.1	19	27.8	12.2	16.4	24.2
BRANCH CIRCUIT FUSE (AMPS)	15	15	20	30	15	20	30	15	15	20	30	15	20	30

Chassis Specifications

PDE Series Air Conditioner with Electric Heat - Chassis Specifications								
MODEL	PDE07K	PDE07R	PDE09K	PDE09R	PDE12K	PDE12R	PDE15K	PDE15R
PERFORMANCE DATA:								
COOLING BTUh	7500/7300	7500	9000/8800	9000	11500/11300	11500	14500/14000	14000
EER	11.6	11.4	11.4	11.0	10.2	10.1	9.42/9.3	9.3
DEHUMIDIFICATION (pints/hr)	1.7	1.6	3.4	3.3	2.9	2.8	3.8	3.8
ELECTRICAL DATA:								
VOLTAGE (1 PHASE, 60 Hz)	230/208	265	230/208	265	230/208	265	230/208	265
CURRENT (AMPS)	3.3/3.4	2.9	3.6/3.9	3.3	5.5/5.8	4.6	7.0/7.4	6.4
AMPS L.R.	13.0	15.0	19.8	16.8	27.0	23.0	32.0	27.0
AMPS F.L.	2.9	2.6	3.7	3.2	5.0	4.0	6.3	5.6
AIRFLOW DATA:								
INDOOR CFM, HIGH	220	245	220	210	325	315	310	340
INDOOR CFM, LOW	200	200	200	200	260	260	280	280
VENT CFM	60	60	60	60	70	70	70	70
PHYSICAL DATA:								
DIMENSIONS	16x42x13.5	16x42x13.5	16x42x13.5	16x42x13.5	16x42x13.5	16x42x13.5	16x42x13.5	16x42x13.5
NET WEIGHT	105	105	112	112	120	120	125	125
SHIPPING WEIGHT	125	125	132	132	140	140	145	145
R-410A CHARGE (oz)	42	35	36	35	33	35	48	42

PDH Series Heat Pump - Chassis Specifications								
MODEL	PDH07K	PDH07R	PDH09K	PDH09R	PDH12K	PDH12R	PDH15K	PDH15R
PERFORMANCE DATA:								
COOLING BTUh	7300/7300	7200	8500/8300	8500	11500/11300	12000	14000/13800	14000
EER	11.1/11.1	11.1	10.8	10.5	9.8	9.7	9.2	9.2
REVERSE HEATING BTUh	6400/6200	6300	8000	7700	10500	10500	12800	12800
POWER (WATTS) HEAT	625/606	615	781	752	1025	1025	1250	1250
COP	3.0/3.0	3.0	3.0	3.0	3.0	3.0	3.0	3.0
DEHUMIDIFICATION (pints/hr)	1.3	1.3	1.9	2.1	2.8	2.9	3.6	3.7
ELECTRICAL DATA:								
VOLTAGE (1 PHASE, 60 Hz)	230/208	265	230/208	265	230/208	265	230/208	265
CURRENT (AMPS)	3.2/3.3	2.8	3.6/3.9	3.3	5.4/5.7	5.2	6.7/7.3	6.3
REVERSE HEAT. Amps	2.7/2.8	2.6	4.3/4.5	3.0	4.4/4.7	4.4	6.2/6.5	5.6
AMPS L.R.	13.0	15.0	19.8	16.8	27.0	23.0	32.0	27.0
AMPS F.L.	2.9	2.6	3.7	3.2	5.0	4.5	6.3	5.6
AIRFLOW DATA:								
INDOOR CFM, HIGH	210	240	220	210	320	310	315	330
INDOOR CFM, LOW	200	200	200	200	260	260	280	280
VENT CFM	60	60	60	60	70	70	70	70
PHYSICAL DATA:								
DIMENSIONS	16x42x13.5	16x42x13.5	16x42x13.5	16x42x13.5	16x42x13.5	16x42x13.5	16x42x13.5	16x42x13.5
NET WEIGHT	105	105	112	112	120	120	125	125
SHIPPING WEIGHT	125	125	132	132	140	140	145	145
R-410A CHARGE (oz)	37	37	37	33	41	40	39	42

Extended Performance 208-230 Volt Models

PDE - EXTENDED COOLING PERFORMANCE																
		OUTDOOR DRY BULB TEMP. (DEGREES F AT 40% R.H.)														
		75			85			95			105			110		
		INDOOR WET BULB TEMP. (DEGREES F AT 80 F D.B.)														
		72	67	62	72	67	62	72	67	62	72	67	62	72	67	62
PDE07	BTUh	8820	8483	7853	8400	7920	7305	8070	7500	6638	7560	6713	5918	6728	5790	5115
	WATTS	528	536	542	575	581	588	647	647	647	699	699	701	763	763	766
	AMPS	2.7	2.7	2.8	2.9	3.0	3.0	3.3	3.30	3.3	3.6	3.6	3.6	3.9	3.9	3.9
	SHR	0.53	0.72	0.96	0.54	0.74	0.98	0.54	0.77	0.99	0.55	0.81	0.99	0.58	0.87	0.99
PDE09	BTUh	10584	10179	9423	10080	9504	8766	9684	9000	7965	9072	8055	7101	8073	6948	6138
	WATTS	644	654	661	701	709	717	789	789	789	853	852	854	930	930	934
	AMPS	3.0	3.0	3.0	3.2	3.2	3.2	3.6	3.60	3.6	3.9	3.9	3.9	4.2	4.2	4.2
	SHR	0.49	0.66	0.89	0.5	0.69	0.91	0.50	0.71	0.91	0.51	0.75	0.92	0.54	0.80	0.91
PDE12	BTUh	13524	13007	12041	12880	12144	11201	12374	11500	10178	11592	10293	9074	10316	8878	7843
	WATTS	920	934	944	1002	1012	1024	1127	1127	1127	1218	1217	1221	1329	1329	1334
	AMPS	4.6	4.6	4.6	4.9	4.9	5.0	5.5	5.50	5.5	5.9	5.9	5.9	6.5	6.5	6.5
	SHR	0.49	0.66	0.89	0.50	0.69	0.91	0.50	0.71	0.91	0.51	0.75	0.92	0.54	0.8	0.91
PDE15	BTUh	16464	15834	14658	15680	14784	13636	15064	14000	12390	14112	12530	11046	12558	10808	9548
	WATTS	1228	1248	1261	1338	1351	1368	1505	1505	1505	1627	1625	1630	1774	1774	1782
	AMPS	5.8	5.8	5.9	6.2	6.3	6.3	7.0	7.00	7.0	7.5	7.5	7.6	8.2	8.2	8.2
	SHR	0.47	0.63	0.85	0.48	0.66	0.87	0.48	0.68	0.87	0.49	0.72	0.88	0.51	0.77	0.87

RATING POINT
ARI 310/380

PDH - EXTENDED COOLING PERFORMANCE																
		OUTDOOR DRY BULB TEMP. (DEGREES F AT 40% R.H.)														
		75			85			95			105			110		
		INDOOR WET BULB TEMP. (DEGREES F AT 80 F D.B.)														
		72	67	62	72	67	62	72	67	62	72	67	62	72	67	62
PDH07	BTUh	8585	8256	7643	8176	7709	7110	7855	7300	6461	7358	6534	5760	6548	5636	4979
	WATTS	537	545	551	585	591	598	658	658	658	711	711	713	776	776	779
	AMPS	2.6	2.7	2.7	2.9	2.9	2.9	3.2	3.20	3.2	3.4	3.4	3.5	3.8	3.8	3.8
	SHR	0.53	0.73	0.98	0.55	0.75	1.00	0.55	0.78	1.00	0.56	0.82	1.01	0.59	0.88	1.00
PDH09	BTUh	9996	9614	8900	9520	8976	8279	9146	8500	7523	8568	7608	6707	7625	6562	5797
	WATTS	642	652	660	700	707	715	787	787	787	851	850	852	928	928	932
	AMPS	3.0	3.0	3.0	3.2	3.2	3.2	3.6	3.60	3.6	3.9	3.9	3.9	4.2	4.2	4.2
	SHR	0.50	0.68	0.91	0.51	0.71	0.93	0.51	0.73	0.94	0.53	0.77	0.94	0.55	0.82	0.93
PDH12	BTUh	13524	13007	12041	12880	12144	11201	12374	11500	10178	11592	10293	9074	10316	8878	7843
	WATTS	957	972	983	1043	1053	1066	1173	1173	1173	1268	1267	1270	1383	1383	1389
	AMPS	4.5	4.5	4.5	4.8	4.8	4.9	5.4	5.40	5.4	5.8	5.8	5.8	6.3	6.3	6.4
	SHR	0.49	0.67	0.90	0.50	0.70	0.92	0.51	0.72	0.92	0.52	0.76	0.93	0.54	0.81	0.92
PDH15	BTUh	16464	15834	14658	15680	14784	13636	15064	14000	12390	14112	12530	11046	12558	10808	9548
	WATTS	1242	1262	1275	1353	1367	1383	1522	1522	1522	1645	1644	1648	1794	1794	1802
	AMPS	5.5	5.6	5.6	6.0	6.0	6.0	6.7	6.7	6.7	7.2	7.2	7.2	7.9	7.9	7.9
	SHR	0.48	0.65	0.88	0.49	0.68	0.89	0.49	0.70	0.90	0.50	0.74	0.9	0.53	0.79	0.9

RATING POINT
ARI 310/380

EXTENDED HEATING PERFORMANCE						
		OUTDOOR DRY BULB TEMP. (DEGREES F)				
		37	42	47	52	57
PDH07	BTUh	5333	5628	6400	7009	7741
	WATTS	589	600	625	635	671
	AMPS	2.6	2.8	2.75	2.9	3
PDH09	BTUh	5930	6320	8000	8540	9130
	WATTS	701	712	781	786	797
	AMPS	3.8	3.8	3.9	3.9	4
PDH12	BTUh	7582	8372	10500	11067	12006
	WATTS	896	931	1025	1055	1089
	AMPS	4.2	4.3	4.7	4.9	5.1
PDH15	BTUh	10134	10442	12800	14003	15341
	WATTS	1151	1166	1250	1324	1384
	AMPS	5.7	5.8	6.3	6.6	6.9

RATING POINT
ARI 310/380

ELECTRICAL RATING TABLES

⚠ WARNING

ELECTRIC SHOCK HAZARD

Turn off electric power before service or installation. All electrical connections and wiring **MUST** be installed by a qualified electrician and conform to the National Electrical Code and all local codes which have jurisdiction. Failure to do so could result in serious personal injury or death.

NOTE: Use Copper Conductors ONLY. Wire sizes are per NEC, check local codes for overseas applications.

Table 1 250 V Receptacles and Fuse Types			
AMPS	15	20*	30
RECEPTACLE			
TIME-DELAY TYPE FUSE (or HACR circuit breaker)	15	20	30

HACR – Heating, Air Conditioning, Refrigeration
 * May be used for 15 Amp applications if fused for 15 Amp
 NOTE: 265 volt units are hard wired.

Table 2 Recommended branch circuit wire sizes*	
NAMEPLATE / MAXIMUM CIRCUIT BREAKER SIZE	AWG WIRE SIZE**
15	14
20	12
30	10

AWG – American Wire Gauge
 * Single circuit from main box
 ** Based on copper wire, single insulated conductor at 60°C

WIRE SIZE	Use ONLY wiring size recommended for single outlet branch circuit.
FUSE/CIRCUIT BREAKER	Use ONLY type and size fuse or HACR circuit breaker indicated on unit's rating plate. Proper current protection to the unit is the responsibility of the owner. NOTE: A time delay fuse is provided with 265V units.
GROUNDING	Unit MUST be grounded from branch circuit through service cord to unit, or through separate ground wire provided on permanently connected units. Be sure that branch circuit or general purpose outlet is grounded. The field supplied outlet must match plug on service cord and be within reach of service cord. Refer to Table 1 for proper receptacle and fuse type. Do NOT alter the service cord or plug. Do NOT use an extension cord.
RECEPTACLE	The field supplied outlet must match plug on service cord and be within reach of service cord. Refer to Table 1 for proper receptacle and fuse type. Do NOT alter the service cord or plug. Do NOT use an extension cord.
WIRE SIZING	Use recommended wire size given in Table 2 and install a single branch circuit. All wiring must comply with local and national codes. NOTE: Use copper conductors only.

POWER CORD INFORMATION (230/208V MODELS ONLY)

All Friedrich 230/208V PTAC units are shipped from the factory with a Leakage Current Detection Interrupter (LCDI) equipped power cord. The LCDI device meets the UL and NEC requirements for cord connected air conditioners effective August 2004.

To test your power supply cord:

1. Plug power supply cord into a grounded 3 prong outlet.
2. Press RESET.
3. Press TEST (listen for click; Reset button trips and pops out).
4. Press and release RESET (listen for click; Reset button latches and remains in). The power supply cord is ready for operation.

NOTE: The LCDI device is not intended to be used as a switch.

Once plugged in the unit will operate normally without the need to reset the LCDI device. If the LCDI device trips and

requires resetting the cause of the trip should be identified prior to further use of the PTAC.

If the device fails to trip when tested or if the power supply cord is damaged it must be replaced with a new supply cord obtained from the product manufacturer, and must not be repaired.

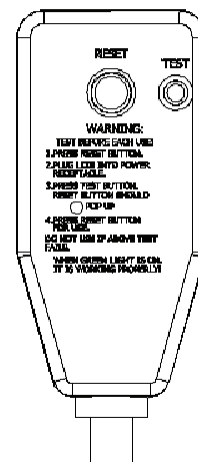

REMOTE THERMOSTAT AND LOW VOLTAGE CONTROL CONNECTIONS

Room Thermostats

Room thermostats are available from several different manufacturers in a wide variety of styles. They range from the very simple Bimetallic type to the complex electronic set-back type. In all cases, no matter how simple or complex, they are simply a switch (or series of switches) designed to turn equipment (or components) "ON" or "OFF" at the desired conditions.

An improperly operating, or poorly located room thermostat can be the source of perceived equipment problems. A careful check of the thermostat and wiring must be made then to insure that it is not the source of problems.

Remote Thermostat

All Friedrich PD model PTAC units are factory configured to be controlled by either the chassis mounted Smart Center or a 24V single stage remote wall mounted thermostat. The thermostat may be auto or manual changeover as long as the control configuration matches that of the PTAC unit.

Manual Changeover Thermostat

For Heat Pump equipped units: A single stage, heat/cool thermostat with a terminal for a reversing valve operation is required. Terminal "B" should be continuously energized in the heat mode and terminal "G" should be energized whenever there is a call for heating or cooling. Typically, a single stage, heat/cool thermostat designed for use with electric heat systems will meet the above requirements.

To control the unit with a wall mounted thermostat follow the steps below:

- 1) With the front cover removed locate the low voltage terminal strip at the lower portion of the Smart Center.
- 2) Remove the jumper between the 'GL' and GH' terminals.
- 3) The control is now configured for control by a wall thermostat. The Smart Center will no longer control the unit.
- 4) If desired the accessory escutcheon kit (PDXRT) is to be used, install it over the existing control panel

Note: To revert back to the Smart Center control of the unit replace the jumper wire between the 'GL' and 'GH' terminals that was removed in step 1.

Remote Thermostat Control

Heat Pump with Electric Heat Operation

When there is a call for heat from the wall thermostat the control board will receive signals on terminals W, B, GL or GH. During compressor lock-out time, the electric heat will turn on first. When the compressor lock-out time is up, the compressor will turn on. If the outdoor coil temperature sensor drops to 30° F or less for 2 consecutive minutes then the unit will switch to electric heat.

Thereafter, the unit will switch back to heat pump heat if the outdoor coil temperature sensor rises to 45° F or greater.

Thermostat Connections

- C = Common Ground
- W = Call for Heating
- Y = Call for Cooling
- R = 24V Power from Unit
- GL = Call for Low Fan
- GH = Call for High Fan
- B = Reversing Valve Energized in heating mode (PDH Models Only)

*If only one G terminal is present on thermostat connect to GL for low fan or to GH for high fan operation.

NOTE: It is the installer's responsibility to ensure that all control wiring connections are made in accordance with the Friedrich installation instructions. Improper connection of the thermostat control wiring and/or tampering with the unit's internal wiring can void the equipment warranty. Questions concerning proper connections to the unit should be directed to the factory: 210-357-4400.

Location

The thermostat should not be mounted where it may be affected by drafts, discharge air from registers (hot or cold), or heat radiated from the sun or appliances.

The thermostat should be located about 5 Ft. above the floor in an area of average temperature, with good air circulation. Close proximity to the return air grille is the best choice.

Mercury bulb type thermostats MUST be level to control temperature accurately to the desired set-point. Electronic digital type thermostats SHOULD be level for aesthetics.

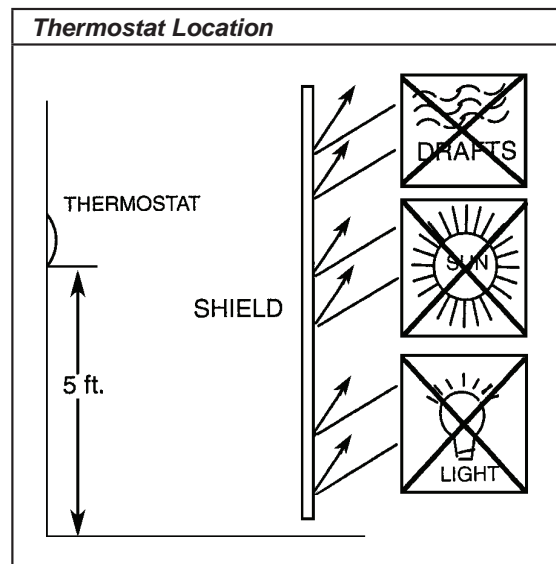

FRIEDRICH DIGITAL CONTROL FEATURES

The new Friedrich digital PTAC has state of the art features to improve guest comfort, indoor air quality and conserve energy. Through the use of specifically designed control software for the PTAC industry Friedrich has accomplished what other Manufacturer's have only attempted – a quiet, dependable, affordable and easy to use PTAC.

Below is a list of standard features on every Friedrich PTAC and their benefit to the owner.

Digital Temperature Readout	By digitally monitoring desired room temperature the room is controlled more precisely than conventional systems. The large, easy to read LED display can show either set-point or actual room temperature as selected by owner.
One-Touch Operation	When the unit is powered off the unit can be returned directly to heating or cooling mode by pressing the 'Heat' or 'Cool' buttons without the confusing power up sequence of some controls. One-touch control takes guess-work out of unit control delivering a more enjoyable experience and eliminating front-desk calls.
Individual Mode and Fan Control Buttons	By having separate control buttons and indicators for both fan and mode settings the Friedrich digital control eliminates the confusion of previous digital PTACs. The accurate temperature setting provides greater guest comfort than other systems.
Quiet Start/Stop Fan Delay	The fan start and stop delays prevent abrupt changes in room acoustics due to the compressor energizing or stopping immediately. Upon call for cooling or heating the unit fan will run for five seconds prior to energizing the compressor. Also, the fan off delay allows for "free cooling" by utilizing the already cool indoor coil to its maximum capacity by running for 30 seconds after the compressor.
Remote Thermostat Operation	Some applications require the use of a wall mounted thermostat. All new Friedrich PTACs may be switched from unit control to remote thermostat control easily without the need to order a special model or accessory kit.
Wireless Remote Control Ready	Guests can adjust the temperature and mode of the unit through the use of an optional hand held wireless remote, improving guest comfort and relaxation.
Internal Diagnostic Program	The new Friedrich digital PTAC features a self diagnostic program that can alert maintenance to component failures or operating problems. The internal diagnostic program saves properties valuable time when diagnosing running problems.
Service Error Code Storage	The self diagnosis program will also store error codes in memory if certain conditions occur and correct themselves such as extreme high or low operating conditions or activation of the room freeze protection feature. Storing error codes can help properties determine if the unit faced obscure conditions or if an error occurred and corrected itself.
Constant Comfort Room Monitoring	The on-board processor monitors time between demand cycles (heat or cool) and will cycle the fan every 9 minutes to sample the room condition and determine if the desired conditions are met. This allows the room to have similar benefits to a remote mounted stat without the complication or cost of a wall mounted thermostat.
Electronic Temperature Limiting	By limiting the operating range the property can save energy by eliminating "max cool" or "max heat" situations common with older uncontrolled systems. The new electronic control allows owners to set operating ranges for both heating and cooling independently of one another.
Room Freeze Protection	When the PTAC senses that the indoor room temperature has fallen to 40°F the unit will cycle on high fan and the electric strip heat to raise the room temperature to 46°F then cycle off again. This feature works regardless of the mode selected and can be turned off. The control will also store the Room Freeze cycle in the service code memory for retrieval at a later date. This feature ensures that unoccupied rooms do not reach freezing levels where damage can occur to plumbing and fixtures.
Random Compressor Restart	Multiple compressors starting at once can often cause electrical overloads and premature unit failure. The random restart delay eliminates multiple units from starting at once following a power outage or initial power up. The compressor delay will range from 180 to 240 seconds.
Digital Defrost Thermostat	The new Friedrich PTAC uses a digital thermostat to accurately monitor the outdoor coil conditions to allow the heat pump to run whenever conditions are correct. Running the PTAC in heat pump mode save energy and reduces operating costs. The digital thermostat allows maximization of heat pump run time.

FRIEDRICH DIGITAL CONTROL FEATURES CONTINUED

Instant Heat Heat Pump Mode	Heat pump models will automatically run the electric heater to quickly bring the room up to temperature when initially energized, then return to heat pump mode. This ensures that the room is brought up to temperature quickly without the usual delay associated with heat pump units.
Even Heat Monitoring	The digital control monitors indoor conditions to ensure that the room temperature is within five degrees of the setpoint. If necessary the unit will cycle the electric heat to maintain the temperature. This feature ensures guest comfort by delivering the heating benefits of an electric heater while maintaining the efficiency benefits of a heat pump.
Fan Cycle Control	The owner may choose between fan cycling or fan continuous mode based on property preference. (Note: Even heat monitoring and quiet start/stop fan delay only operate in fan cycle mode). Fan continuous mode is used to keep constant airflow circulation in the room during all times the unit is 'ON'. Fan cycle will conserve energy by only operating the fan while the compressor or electric heater is operating.
Emergency Heat Override	In the event of a compressor failure in heat pump mode the compressor may be locked out to provide heat through the resistance heater. This feature ensures that even in the unlikely event of a compressor failure the room temperature can be maintained until the compressor can be serviced.
Desk Control Ready	All Friedrich digital PTACs have low voltage terminals ready to connect a desk control energy management system. Controlling the unit from a remote location like the front desk can reduce energy usage and requires no additional accessories at the PTAC.
Indoor Coil Frost Sensor	The frost sensor protects the compressor from damage in the event that airflow is reduced or low outdoor temperatures cause the indoor coil to freeze. When the indoor coil reaches 30°F the compressor is disabled and the fan continues to operate based on demand. Once the coil temperature returns to 45°F the compressor returns to operation.
Ultra-Quiet Air System	The new Friedrich PD series units feature a indoor fan system design that reduces sound levels without lowering airflow and preventing proper air circulation.
High Efficiency	The Friedrich PTAC benefits quality components and extensive development to ensure a quiet, efficient and dependable unit.
Single Motor	Friedrich's single-motor design allows for enhanced outdoor airflow and simplifies the unit design without the need for redundant components.
Rotary Compressor	High efficiency rotary compressors are used on all Friedrich PTACs to maximize durability and efficiency.
Auxiliary Fan Ready	The Friedrich PTAC features a 24V AC terminal for connection to an auxiliary fan that may be used to transfer air to adjoining rooms. Auxiliary fans can provide conditioning to multiple rooms without the requirement of multiple PTAC units.
Aluminum Endplates	All Friedrich PTACs are built with .04" endplates made from aluminum as opposed to steel. The endplates are typically the most susceptible area for corrosion and aluminum is far more resistant to corrosion than even coated steel.
Seacoast Protection	Optional Seacoast protection is available to protect the outdoor coil from harsh environments. The Friedrich Seacoast process includes dipping the entire outdoor coil in a 7-step coating process that provides superior protection to only coating the fins of the coil.
Top Mounted Anti-microbial Air Filters	All Friedrich PTAC return air filters feature an anti-microbial element that has proven to prevent mold and bacterial growth in laboratory testing. PDXFT replacement filter kits feature the same anti-microbial agent. All filters are washable and reusable and are easily accessed from the top of the unit without the removal of the front cover.
Filtered Fresh Air Intake	Friedrich PTAC units are capable of introducing up to 70 CFM of outside air into the conditioned space. The outdoor air passes through a washable mesh filter to prevent debris from entering the airstream.

DIGITAL CONTROL OPERATION

Temperature Display

The Friedrich digital PTAC is shipped from the factory to display the “Set Point” (desired room temperature) on the LED readout.

The unit can be configured to display the room temperature by simultaneously pressing the **‘Cool’** and **‘High Fan’** buttons for three seconds. The display will show an **‘R’** for one second to acknowledge the change. The unit will then display the “Set Point” whenever the Temperature Up **▲** or Temperature Down **▼** buttons are pressed, then switch back to display actual room temperature.

To revert back to the factory setting displaying the “Set Point” only, press the **‘Cool’** and **‘High Fan’** buttons simultaneously for three seconds. The unit will display an **‘S’** for one second to acknowledge the change.

°F vs. °C Display

The unit is factory configured to display all temperatures in degrees Fahrenheit (°F). To switch to degrees Celsius press the **‘Fan Only’** and **‘Low Fan’** buttons simultaneously for three seconds. The display will show a **‘C’** as acknowledgement of the change.

To revert back to degrees Fahrenheit press the **‘Fan Only’** and **‘Low Fan’** buttons simultaneously for three seconds. The display will show an **‘F’** as acknowledgement of the change.

Cooling Mode

Pressing the **‘Cool’** button while the unit is in any mode, including off, will put the unit into cooling mode. Adjust the temperature readout to the desired room temperature and the unit will cycle the compressor on and off to maintain a comfortable room. The compressor will come on anytime that the room temperature is 1.8°F above the desired temperature. The fan operation is dependent on the fan mode selected, either continuous or cycling.

Heating Mode

Pressing the **‘Heat’** button while the unit is in any mode, including off, will put the unit into heating mode.

Heat Pump Models (PDH)

When the **‘Heat’** button is pressed initially the unit will energize the electric resistance heat to quickly bring the room to the set temperature. When the desired room temperature falls 1.8°F below the desired set temperature the unit will cycle the compressor on and operate as a heat pump to maintain the room temperature while running more efficiently than resistance heat only models. If the room temperature should fall more than 5°F from the set temperature the unit will run the resistance heater. The fan operation is dependent on the fan mode selected, either continuous or cycling. Dip switch 5 controls the fan mode, see “Dip Switch” setting elsewhere in this manual.

When the outdoor coil temperature falls below 30°F for more than 2 minutes the unit will operate the resistance heaters and not the compressor. When the outdoor coil temperature reaches 45°F the compressor will be allowed to operate again.

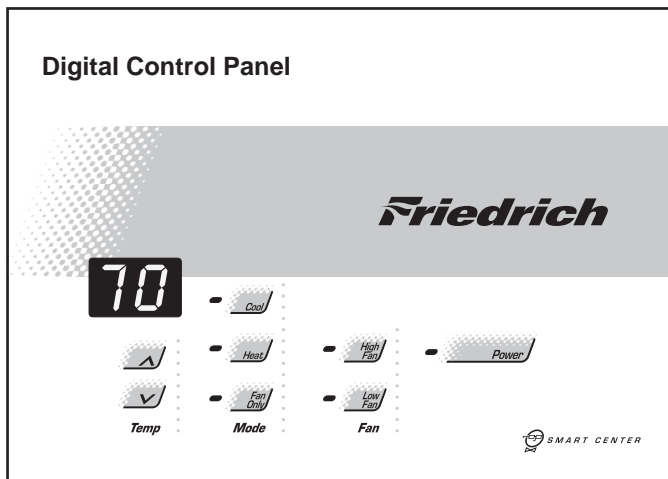

Heat/Cool Models (PDE)

After pressing the **‘Heat’** button, adjust the temperature readout to the desired room temperature and the unit will cycle the resistance heat on and off to maintain a comfortable room. The heater will come on anytime that the room temperature is 1.8°F below the desired temperature. The fan operation is dependent on the fan mode selected, either continuous or cycling. Dip switch 5 controls the fan mode, see “Dip Switch” setting elsewhere in the manual.

Emergency Heat Operation

In the event of a compressor failure in heat pump mode the compressor may be locked out to provide heat through the resistance heater. This feature ensures that even in the unlikely event of a compressor failure the room temperature can be maintained until the compressor can be serviced. Dip switch 7 controls the emergency heat setting, see “Dip Switch” setting elsewhere in the manual.

Fan Mode

Fan Only

Pressing the **‘Fan Only’** button will run the fan to allow for air circulation in the room without operating the compressor or heater regardless of the room or set temperature. The fan speed selection is made by pressing either the **‘High Fan’** or **‘Low Fan’** button.

Cycle/Continuous

The owner may choose between fan cycling or fan continuous mode based on property preference. (Note: Even heat monitoring and quiet start/stop fan delay only operate in fan cycle mode). Fan continuous mode is used to keep constant airflow circulation in the room during all times the unit is ‘ON’. Fan cycle will conserve energy by only operating the fan while the compressor or electric heater is operating. Dip switch 5 controls the fan mode, see “Dip Switch” setting elsewhere in the manual.

Optional Hand Held Remote Control Operation

The electronic control can be configured to operate via an optional hand held remote control for added convenience. The PTAC control board comes shipped with all of the necessary hardware to communicate to the PDXRC remote control. In order to operate the unit with the remote control, the remote control sensor must be enabled. Simply press and hold the 'Temp' ▲ and ▼ buttons simultaneously for 3 seconds and the LED window will display an "E" for confirmation that the remote is enabled. To disable the feature press 'Temp' ▲ and ▼ buttons at the same time for 3 seconds. LED will display an "0" as acknowledgement for 1 second. The remote control is now ready for use. The temperature, mode and fan speed control from the remote control will operate the unit the same as the unit mounted controls. NOTE: The hand held remote control cannot be used in conjunction with a wall mounted thermostat.

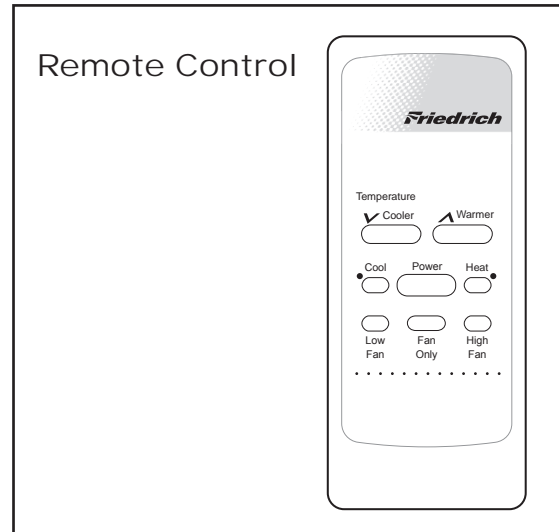

Digital Control Diagnostics and Test Mode

Diagnostics

The Friedrich Smart Center continuously monitors the PTAC unit operation and will store service codes if certain conditions are witnessed. In some cases the unit may take action and shut the unit off until conditions are corrected.

To access the error code menu press the 'Heat' and 'High Fan' buttons simultaneously for three seconds. If error codes are present they will be displayed. If multiple codes exist you can toggle between messages using the temp up ▲ button. To clear all codes press the temp

down ▼ button for three seconds while in the error code mode. To exit without changing codes press the 'Low Fan' button.

Button Location with Optional PDXRT Escutcheon Kit Installed

If the remote escutcheon kit is installed, the button locations to access the diagnostics and tests modes can be located as shown below.

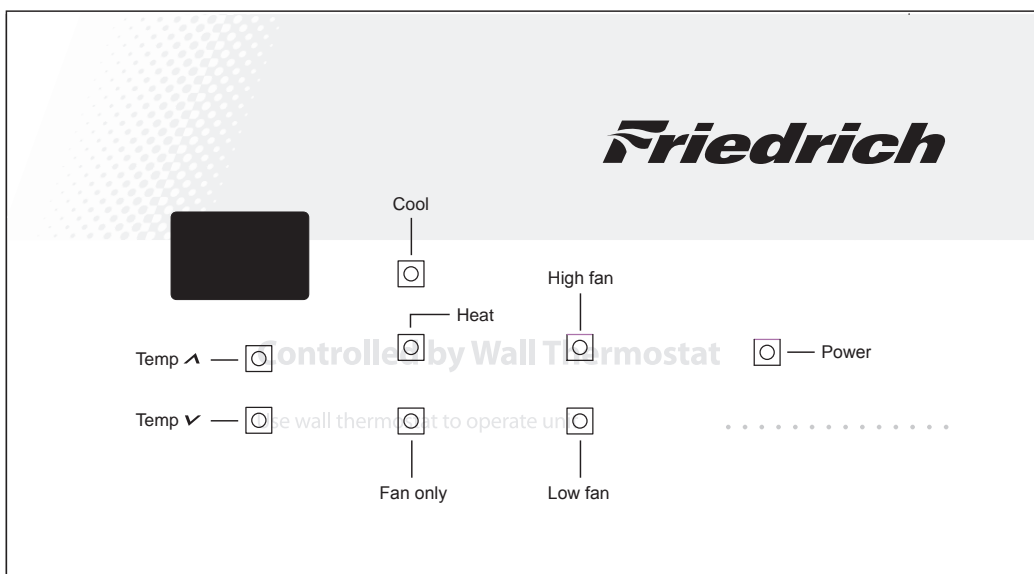

Electronic Control Error Code Diagnostics

Error Code	Code Translation	Action Taken By Unit	Possible Cause
EF	Error Free	None	Unit Operating Normally
02	An extreme low voltage condition exists <198V for 230V units and <239V for 265V units.	Shut unit down. Flash error code. When voltage rises to adequate level normal unit operation is restored.	<ul style="list-style-type: none"> Inadequate power supply Defective breaker Blown fuse
03	Return air thermistor sensor open or short circuit	Leave unit running. Alternately flash error code and set point.	<ul style="list-style-type: none"> Defective sensor
04	Indoor coil thermistor sensor open or short circuit	Leave unit running. Alternately flash error code and set point.	<ul style="list-style-type: none"> Defective sensor
05	Outdoor coil thermistor sensor open or short circuit	Leave unit running. Switch to Electric Heat Mode (Heat Pump only). Alternately flash error code and set point.	<ul style="list-style-type: none"> Defective sensor
06	Outdoor coil Temperature > 175° F for 2 consecutive minutes. (Heat Pump models only)	Shut unit down for 5 minutes, Alternately flash error code and set point, then try again 2 times, if unit fails the 3rd time then shut unit down and alternately flash error code and set point.	<ul style="list-style-type: none"> Dirty coil Fan motor failure Restricted air flow Non-condensables in refrigeration sys
07	Indoor coil temperature <30° F for 2 consecutive minutes.	Shut down Compressor, and continue fan operation. Alternately flash error code and set point until the indoor coil thermistor reaches 45° F. Then, (after lockout time of 180 to 240 seconds expires), re-energize the compressor.	<ul style="list-style-type: none"> Dirty filters Dirty coil Fan motor failure Restricted air flow Improper refrigerant charge Restriction in refrigerant circuit
08	Unit cycles (Heat or Cool demand) > 9 times per hour	Leave unit running. Store error code in memory.	<ul style="list-style-type: none"> Unit oversized Low load conditions
09	Unit cycles (Heat or Cool demand) < 3 times per hour	Leave unit running. Store Error Code in memory.	<ul style="list-style-type: none"> Unit undersized High load conditions
10	Room Freeze Protection triggered	Leave unit running. Alternately flash error code and set point.	<ul style="list-style-type: none"> Room temperature fell below 40°F
11	No Signal to "GL" or "GH" terminal	Shut unit down. Flash error code.	<ul style="list-style-type: none"> Defective remote thermostat Defective thermostat wiring
12	Discharge air temperature >185° F	Shut down Compressor and/or Heater, and energize high fan. Alternately flash error code and set point. If condition repeats three times in one hour, shut unit down.	<ul style="list-style-type: none"> Restricted air flow Fan motor failure
13	Pressure switch jumper wire loose/missing High Pressure switch open (If so equipped)	Shut unit down. Flash error code.	<ul style="list-style-type: none"> Dirty coil Fan motor failure Restricted air flow Non-condensables in refrigeration system
14	Discharge air temperature sensor open or shorted	Leave unit running. Alternately flash error code and set point.	<ul style="list-style-type: none"> Defective Sensor

Diagnostics

The Friedrich Smart Center continuously monitors the PTAC unit operation and will store service codes if certain conditions are witnessed. In some cases the unit may take action and shut the unit off until conditions are corrected.

To access the error code menu press the **'Heat'** and **'High Fan'** buttons simultaneously for three seconds. If error codes are present they will be displayed. If multiple codes exist you can toggle between messages using the temp **▲** button. To clear all codes press the temp **▼** button for three seconds while in the error code mode. To exit without changing codes press the **'Low Fan'** button.

EF = Error Free

Test Mode

For service and diagnostic use only, the built-in timers and delays on the PTAC may be bypassed by pressing the **'Cool'** and **'Low Fan'** buttons simultaneously for three seconds while in any mode to enter the test mode. **CE** will be displayed when entering test mode, and **DE** will be displayed when exiting. The test mode will automatically be exited 30 minutes after entering it or by pressing the **'Cool'** and **'Low Fan'** buttons simultaneously for three seconds.

Note:

To access the **Test Mode** while under remote wall thermostat operation, remove thermostat's wires at the terminal block on the electronic control board then connect a jumper wire between GL and GH.

COMPONENTS TESTING

BLOWER/FAN MOTOR

A single phase permanent split capacitor motor is used to drive the evaporator blower and condenser fan. A self-resetting overload is located inside the motor to protect against high temperature and high amperage conditions.

⚠ WARNING	
	ELECTRIC SHOCK HAZARD Disconnect power to the unit before servicing. Failure to follow this warning could result in serious injury or death.

BLOWER/FAN MOTOR TEST

1. Make sure the motor has cooled down.
2. Disconnect the fan motor wires from the control board.
3. Test for continuity between the windings also, test to ground.
4. If any winding is open or grounded replace the motor.

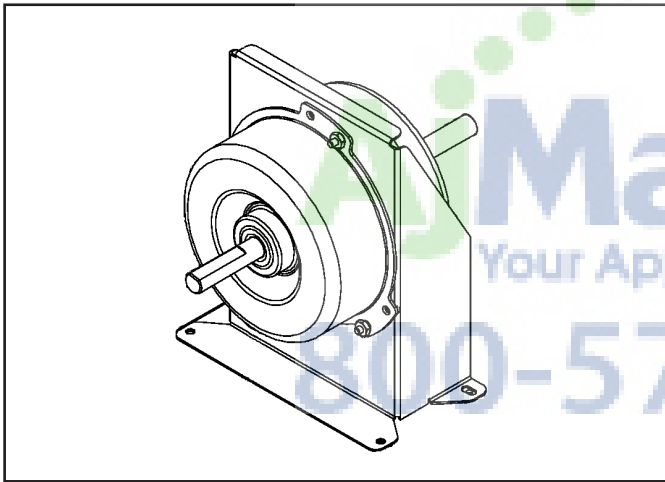

CAPACITORS

⚠ WARNING	
	ELECTRIC SHOCK HAZARD Turn off electric power before servicing. Discharge capacitor with a 20,000 Ohm 2 Watt resistor before handling. Failure to do so may result in personal injury, or death.

Many motor capacitors are internally fused. Shorting the terminals will blow the fuse, ruining the capacitor. A 20,000 ohm 2 watt resistor can be used to discharge capacitors safely. Remove wires from capacitor and place resistor across terminals. When checking a dual capacitor with a capacitor analyzer or ohmmeter, both sides must be tested.

Capacitor Check with Capacitor Analyzer

The capacitor analyzer will show whether the capacitor is “open” or “shorted.” It will tell whether the capacitor is within its micro farads rating and it will show whether the capacitor is operating at the proper power-factor percentage. The instrument will automatically discharge the capacitor when the test switch is released.

Capacitor Connections

The starting winding of a motor can be damaged by a shorted and grounded running capacitor. This damage usually can be avoided by proper connection of the running capacitor terminals.

From the supply line on a typical 230 volt circuit, a 115 volt potential exists from the “R” terminal to ground through a possible short in the capacitor. However, from the “S” or start terminal, a much higher potential, possibly as high as 400 volts, exists because of the counter EMF generated in the start winding. Therefore, the possibility of capacitor failure is much greater when the identified terminal is connected to the “S” or start terminal. The identified terminal should always be connected to the supply line, or “R” terminal, never to the “S” terminal.

When connected properly, a shorted or grounded running capacitor will result in a direct short to ground from the “R” terminal and will blow the line fuse. The motor protector will protect the main winding from excessive temperature.

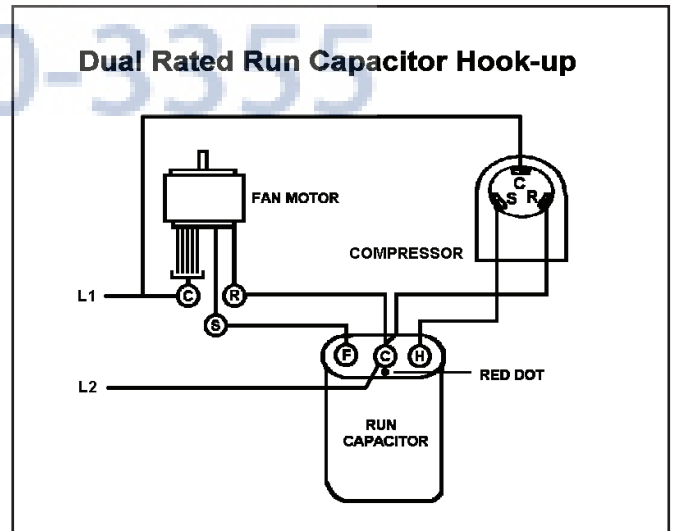

COMPONENTS TESTING (Continued)

HEATER ELEMENTS AND LIMIT SWITCHES' SPECIFICATIONS

All heat pumps and electric heat models are equipped with a heating element and a limit switch (bimetal thermostat). The limit is in series with the element and will interrupt the power at a designed temperature.

Should the blower motor fail, filter become clogged or air-flow be restricted etc., the high limit switch will open and interrupt the power to the heater before reaching an unsafe temperature condition.

TESTING THE HEATING ELEMENTS AND LIMIT SWITCHES

WARNING



ELECTRIC SHOCK HAZARD

Disconnect power to the unit before servicing. Failure to follow this warning could result in serious injury or death.

Testing of the heating elements can be made with an ohmmeter or continuity tester across the terminals after the power wires have been removed. Test the limit switch for continuity across its input and output terminals. Test below the limit switch's reset temperature.

DRAIN PAN VALVE

During the cooling mode of operation, condensate which collects in the drain pan is picked up by the condenser fan blade and sprayed onto the condenser coil. This assists in cooling the refrigerant plus evaporating the water.

During the heating mode of operation, it is necessary that water be removed to prevent it from freezing during cold outside temperatures. This could cause the condenser fan blade to freeze in the accumulated water and prevent it from turning.

To provide a means of draining this water, a bellows type drain valve is installed over a drain opening in the base pan.

This valve is temperature sensitive and will open when the outside temperature reaches 40°F. The valve will close gradually as the temperature rises above 40°F to fully close at 60°F.

Bellows Assembly
Drain Pan Valve

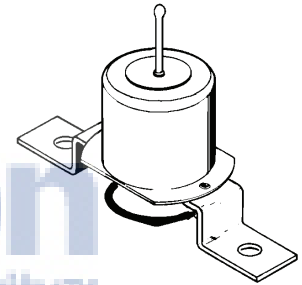

AJ Madison
Your Appliance Authority™

800-570-3355

REFRIGERATION SEQUENCE OF OPERATION

A good understanding of the basic operation of the refrigeration system is essential for the service technician. Without this understanding, accurate troubleshooting of refrigeration system problems will be more difficult and time consuming, if not (in some cases) entirely impossible. The refrigeration system uses four basic principles (laws) in its operation they are as follows:

1. "Heat always flows from a warmer body to a cooler body."
2. "Heat must be added to or removed from a substance before a change in state can occur"
3. "Flow is always from a higher pressure area to a lower pressure area."
4. "The temperature at which a liquid or gas changes state is dependent upon the pressure."

The refrigeration cycle begins at the compressor. Starting the compressor creates a low pressure in the suction line which draws refrigerant gas (vapor) into the compressor. The compressor then "compresses" this refrigerant, raising its pressure and its (heat intensity) temperature.

The refrigerant leaves the compressor through the discharge line as a hot High pressure gas (vapor). The refrigerant enters the condenser coil where it gives up some of its heat. The condenser fan moving air across the coil's finned surface facilitates the transfer of heat from the refrigerant to the relatively cooler outdoor air.

When a sufficient quantity of heat has been removed from the refrigerant gas (vapor), the refrigerant will "condense" (i.e. change to a liquid). Once the refrigerant has been condensed (changed) to a liquid it is cooled even further by the air that continues to flow across the condenser coil.

The PTAC design determines at exactly what point (in the condenser) the change of state (i.e. gas to a liquid) takes place. In all cases, however, the refrigerant must be totally condensed (changed) to a Liquid before leaving the condenser coil.

The refrigerant leaves the condenser Coil through the liquid line as a warm high pressure liquid. It next will pass through the refrigerant drier (if so equipped). It is the function of the drier to trap any moisture present in the system, contaminants, and large particulate matter.

The liquid refrigerant next enters the metering device. The metering device is a capillary tube. The purpose of the metering device is to "meter" (i.e. control or measure) the quantity of refrigerant entering the evaporator coil.

In the case of the capillary tube this is accomplished (by design) through size (and length) of device, and the pressure difference present across the device.

Since the evaporator coil is under a lower pressure (due to the suction created by the compressor) than the liquid line, the liquid refrigerant leaves the metering device entering the evaporator coil. As it enters the evaporator coil, the larger area and lower pressure allows the refrigerant to expand and lower its temperature (heat intensity). This expansion is often referred to as "boiling". Since the unit's blower is moving indoor air across the finned surface of the evaporator coil, the expanding refrigerant absorbs some of that heat. This results in a lowering of the indoor air temperature, hence the "cooling" effect.

The expansion and absorbing of heat cause the liquid refrigerant to evaporate (i.e. change to a gas). Once the refrigerant has been evaporated (changed to a gas), it is heated even further by the air that continues to flow across the evaporator coil.

The particular system design determines at exactly what point (in the evaporator) the change of state (i.e. liquid to a gas) takes place. In all cases, however, the refrigerant must be totally evaporated (changed) to a gas before leaving the evaporator coil.

The low pressure (suction) created by the compressor causes the refrigerant to leave the evaporator through the suction line as a cool low pressure vapor. The refrigerant then returns to the compressor, where the cycle is repeated.

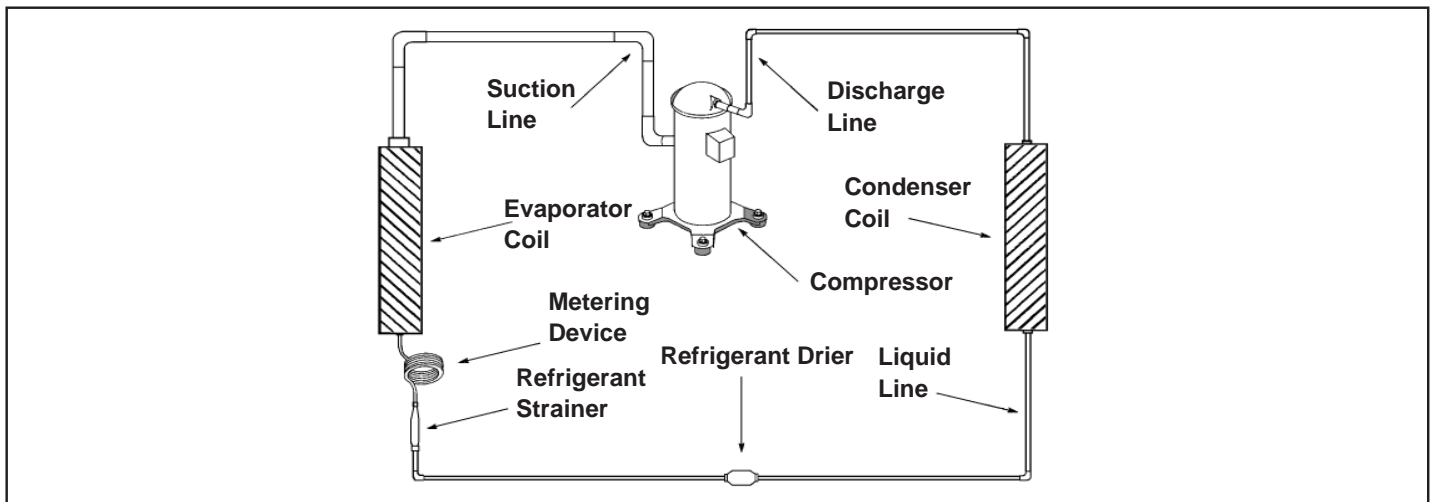

R-410A SEALED REFRIGERATION SYSTEM REPAIRS

IMPORTANT



SEALED SYSTEM REPAIRS TO COOL-ONLY MODELS REQUIRE THE INSTALLATION OF A LIQUID LINE DRIER.
SEALED SYSTEM REPAIRS TO HEAT PUMP MODELS REQUIRE THE INSTALLATION OF A SUCTION LINE DRIER.



EQUIPMENT REQUIRED:

1. Voltmeter
2. Ammeter
3. Ohmmeter
4. E.P.A. Approved Refrigerant Recovery System
5. Vacuum Pump (capable of 200 microns or less vacuum.)
6. Acetylene Welder
7. Electronic Halogen Leak Detector capable of detecting HFC (Hydrofluorocarbon) refrigerants.
8. Accurate refrigerant charge measuring device such as:
 - a. Balance Scales - 1/2 oz. accuracy
 - b. Charging Board - 1/2 oz. accuracy
9. High Pressure Gauge - (0 - 750 lbs.)
10. Low Pressure Gauge - (30 - 200 lbs.)
11. Vacuum Gauge - (0 - 1000 microns)
12. Facilities for flowing nitrogen through refrigeration tubing during all brazing processes.

EQUIPMENT MUST BE CAPABLE OF:

1. Recovering refrigerant to EPA required levels.
2. Evacuation from both the high side and low side of the system simultaneously.
3. Introducing refrigerant charge into high side of the system.
4. Accurately weighing the refrigerant charge introduced into the system.

 WARNING	
	RISK OF ELECTRIC SHOCK Unplug and/or disconnect all electrical power to the unit before performing inspections, maintenances or service. Failure to do so could result in electric shock, serious injury or death.

 WARNING	
	HIGH PRESSURE HAZARD Sealed Refrigeration System contains refrigerant and oil under high pressure. Proper safety procedures must be followed, and proper protective clothing must be worn when working with refrigerants. Failure to follow these procedures could result in serious injury or death.

Too much refrigerant (overcharge) in the system is just as bad (if not worse) than not enough refrigerant (undercharge). They both can be the source of certain compressor failures if they remain uncorrected for any period of time. Quite often, other problems (such as low air flow across evaporator, etc.) are misdiagnosed as refrigerant charge problems. The refrigerant circuit diagnosis chart will assist you in properly diagnosing these systems.

An overcharged unit will at times return liquid refrigerant (slugging) back to the suction side of the compressor eventually causing a mechanical failure within the compressor. This mechanical failure can manifest itself as valve failure, bearing failure, and/or other mechanical failure. The specific type of failure will be influenced by the amount of liquid being returned, and the length of time the slugging continues.

Not enough refrigerant (undercharge) on the other hand, will cause the temperature of the suction gas to increase to the point where it does not provide sufficient cooling for the compressor motor. When this occurs, the motor winding temperature will increase causing the motor to overheat and possibly cycle open the compressor overload protector. Continued overheating of the motor windings and/or cycling of the overload will eventually lead to compressor motor or overload failure.

Refrigerant Charging

Proper refrigerant charge is essential to proper unit operation. Operating a unit with an improper refrigerant charge will result in reduced performance (capacity) and/or efficiency. Accordingly, the use of proper charging methods during servicing will insure that the unit is functioning as designed and that its compressor will not be damaged.

Method Of Charging / Repairs

The acceptable method for charging the RAC system is the Weighed in Charge Method. The weighed in charge method is applicable to all units. It is the preferred method to use, as it is the most accurate.

The weighed in method should always be used whenever a charge is removed from a unit such as for a leak repair, compressor replacement, or when there is no refrigerant charge left in the unit. To charge by this method, requires the following steps:

1. Install a piercing valve to remove refrigerant from the sealed system. (Piercing valve must be removed from the system before recharging.)
2. Recover Refrigerant in accordance with EPA regulations.

⚠ WARNING	
	BURN HAZARD Proper safety procedures must be followed, and proper protective clothing must be worn when working with a torch.
	Failure to follow these procedures could result in moderate or serious injury.

3. Install a process tube to sealed system.

⚠ CAUTION	
	FREEZE HAZARD Proper safety procedures must be followed, and proper protective clothing must be worn when working with liquid refrigerant.
	Failure to follow these procedures could result in minor to moderate injury.

4. Make necessary repairs to system.
5. Evacuate system to 200 microns or less.
6. Weigh in refrigerant with the property quantity of R-410A refrigerant.
7. Start unit, and verify performance.

⚠ WARNING	
	BURN HAZARD Proper safety procedures must be followed, and proper protective clothing must be worn when working with a torch.
	Failure to follow these procedures could result in moderate or serious injury.

8. Crimp the process tube and solder the end shut.

⚠ WARNING	
	ELECTRIC SHOCK HAZARD Turn off electric power before service or installation.
	Extreme care must be used, if it becomes necessary to work on equipment with power applied.
	Failure to do so could result in serious injury or death.

⚠ WARNING	
	HIGH PRESSURE HAZARD Sealed Refrigeration System contains refrigerant and oil under high pressure.
	Proper safety procedures must be followed, and proper protective clothing must be worn when working with refrigerants.
	Failure to follow these procedures could result in serious injury or death.

Undercharged Refrigerant Systems

An undercharged system will result in poor performance (low pressures, etc.) in both the heating and cooling cycle.

Whenever you service a unit with an undercharge of refrigerant, always suspect a leak. The leak must be repaired before charging the unit.

To check for an undercharged system, turn the unit on, allow the compressor to run long enough to establish working pressures in the system (15 to 20 minutes).

During the cooling cycle you can listen carefully at the exit of the metering device into the evaporator; an intermittent hissing and gurgling sound indicates a low refrigerant charge. Intermittent frosting and thawing of the evaporator is another indication of a low charge, however, frosting and thawing can also be caused by insufficient air over the evaporator.

Checks for an undercharged system can be made at the compressor. If the compressor seems quieter than normal, it is an indication of a low refrigerant charge.

A check of the amperage drawn by the compressor motor should show a lower reading. (Check the Unit Specification.)

After the unit has run 10 to 15 minutes, check the gauge pressures. Gauges connected to system with an undercharge will have low head pressures and substantially low suction pressures.

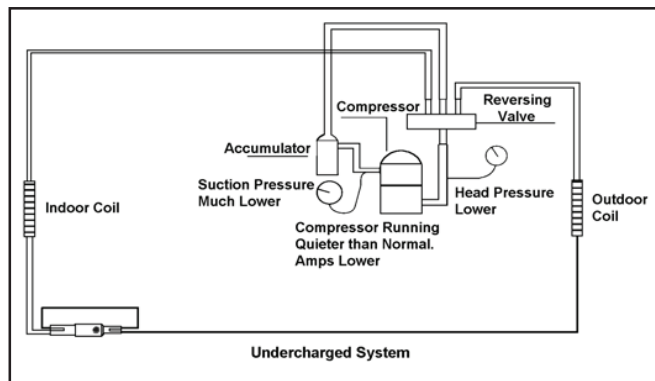

Overcharged Refrigerant Systems

Compressor amps will be near normal or higher. Noncondensables can also cause these symptoms. To confirm, remove some of the charge, if conditions improve, system may be overcharged. If conditions don't improve, Noncondensables are indicated.

Whenever an overcharged system is indicated, always make sure that the problem is not caused by air flow problems.

Improper air flow over the evaporator coil may indicate some of the same symptoms as an over charged system. An overcharge can cause the compressor to fail, since it would be "slugged" with liquid refrigerant.

The charge for any system is critical. When the compressor is noisy, suspect an overcharge, when you are sure that the air quantity over the evaporator coil is correct. Icing of the evaporator will not be encountered because the refrigerant will boil later if at all. Gauges connected to system will usually have higher head pressure (depending upon amount of over charge). Suction pressure should be slightly higher.

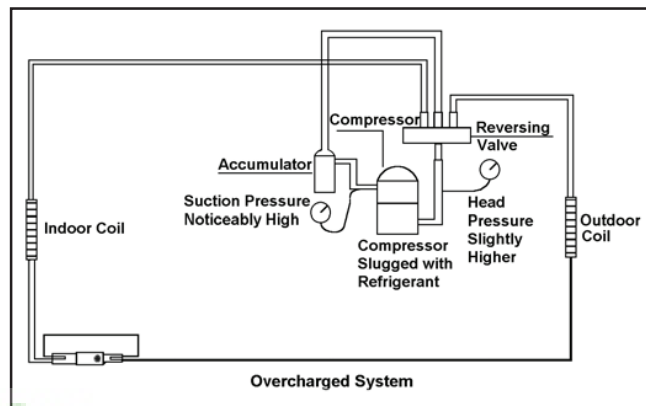

Restricted Refrigerant System

Troubleshooting a restricted refrigerant system can be difficult. The following procedures are the more common problems and solutions to these problems. There are two types of refrigerant restrictions: Partial restrictions and complete restrictions.

A partial restriction allows some of the refrigerant to circulate through the system.

With a complete restriction there is no circulation of refrigerant in the system.

Restricted refrigerant systems display the same symptoms as a "low-charge condition."

When the unit is shut off, the gauges may equalize very slowly.

Gauges connected to a completely restricted system will run in a deep vacuum. When the unit is shut off, the gauges will not equalize at all.

A quick check for either condition begins at the evaporator. With a partial restriction, there may be gurgling sounds at the metering device entrance to the evaporator. The evaporator in a partial restriction could be partially frosted or have an ice ball close to the entrance of the metering device. Frost may continue on the suction line back to the compressor.

Often a partial restriction of any type can be found by feel, as there is a temperature difference from one side of the restriction to the other.

With a complete restriction, there will be no sound at the metering device entrance. An amperage check of the compressor with a partial restriction may show normal current when compared to the unit specification.

With a complete restriction the current drawn may be considerably less than normal, as the compressor is running in a deep vacuum (no load.) Much of the area of the condenser will be relatively cool since most or all of the liquid refrigerant will be stored there.

The following conditions are based primarily on a system in the cooling mode.

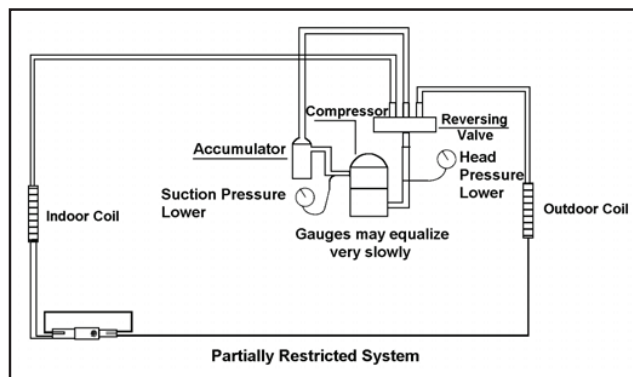
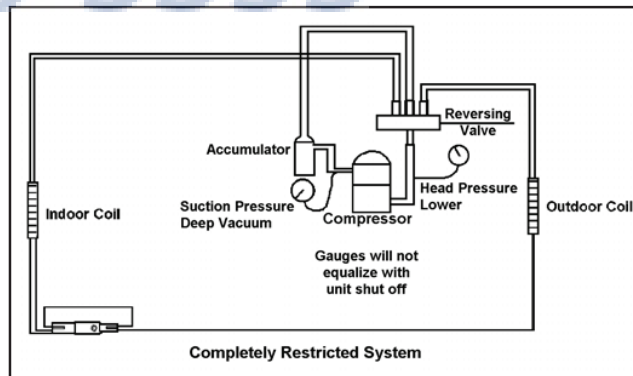

HERMETIC COMPONENTS CHECK

⚠ WARNING	
	BURN HAZARD Proper safety procedures must be followed, and proper protective clothing must be worn when working with a torch. Failure to follow these procedures could result in moderate or serious injury.

⚠ WARNING	
	CUT/SEVER HAZARD Be careful with the sharp edges and corners. Wear protective clothing and gloves, etc. Failure to do so could result in serious injury.

METERING DEVICE

Capillary Tube Systems

All units are equipped with capillary tube metering devices.

Checking for restricted capillary tubes.

1. Connect pressure gauges to unit.
2. Start the unit in the cooling mode. If after a few minutes of operation the pressures are normal, the check valve and the cooling capillary are not restricted.
3. Switch the unit to the heating mode and observe the gauge readings after a few minutes running time. If the system pressure is lower than normal, the heating capillary is restricted.
4. If the operating pressures are lower than normal in both the heating and cooling mode, the cooling capillary is restricted.

CHECK VALVE

A unique two-way check valve is used on the reverse cycle heat pumps. It is pressure operated and used to direct the flow of refrigerant through a single filter drier and to the proper capillary tube during either the heating or cooling cycle.

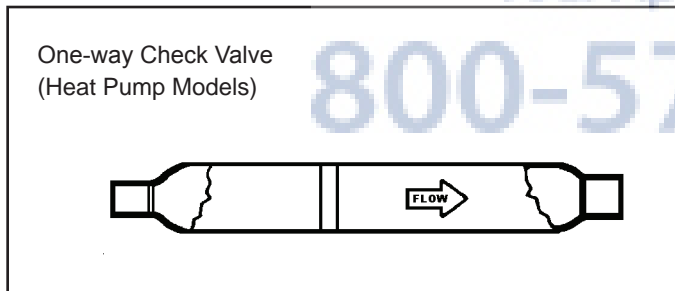

NOTE: The slide (check) inside the valve is made of teflon. Should it become necessary to replace the check valve, place a wet cloth around the valve to prevent overheating during the brazing operation.

CHECK VALVE OPERATION

In the cooling mode of operation, high pressure liquid enters the check valve forcing the slide to close the opposite port (liquid line) to the indoor coil. Refer to refrigerant flow chart. This directs the refrigerant through the filter drier and cooling capillary tube to the indoor coil.

In the heating mode of operation, high pressure refrigerant enters the check valve from the opposite direction, closing

the port (liquid line) to the outdoor coil. The flow path of the refrigerant is then through the filter drier and heating capillary to the outdoor coil.

Failure of the slide in the check valve to seat properly in either mode of operation will cause flooding of the cooling coil. This is due to the refrigerant bypassing the heating or cooling capillary tube and entering the liquid line.

COOLING MODE

In the cooling mode of operation, liquid refrigerant from condenser (liquid line) enters the cooling check valve forcing the heating check valve shut. The liquid refrigerant is directed into the liquid dryer after which the refrigerant is metered through cooling capillary tubes to evaporator. (Note: liquid refrigerant will also be directed through the heating capillary tubes in a continuous loop during the cooling mode).

HEATING MODE

In the heating mode of operation, liquid refrigerant from the indoor coil enters the heating check valve forcing the cooling check valve shut. The liquid refrigerant is directed into the liquid dryer after which the refrigerant is metered through the heating capillary tubes to outdoor coils. (Note: liquid refrigerant will also be directed through the cooling capillary tubes in a continuous loop during the heating mode).

REVERSING VALVE DESCRIPTION/OPERATION

WARNING



ELECTRIC SHOCK HAZARD

Disconnect power to the unit before servicing. Failure to follow this warning could result in serious injury or death.

The Reversing Valve controls the direction of refrigerant flow to the indoor and outdoor coils. It consists of a pressure-operated, main valve and a pilot valve actuated by a solenoid plunger. The solenoid is energized during the heating cycle only. The reversing valves used in the PTAC system is a 2-position, 4-way valve.

The single tube on one side of the main valve body is the high-pressure inlet to the valve from the compressor. The center tube on the opposite side is connected to the low pressure (suction) side of the system. The other two are connected to the indoor and outdoor coils. Small capillary tubes connect each end of the main valve cylinder to the "A" and "B" ports of the pilot valve. A third capillary is a common return line from these ports to the suction tube on the main valve body. Four-way reversing valves also have a capillary tube from the compressor discharge tube to the pilot valve.

The piston assembly in the main valve can only be shifted by the pressure differential between the high and low sides

of the system. The pilot section of the valve opens and closes ports for the small capillary tubes to the main valve to cause it to shift.

NOTE: System operating pressures must be near normal before valve can shift.

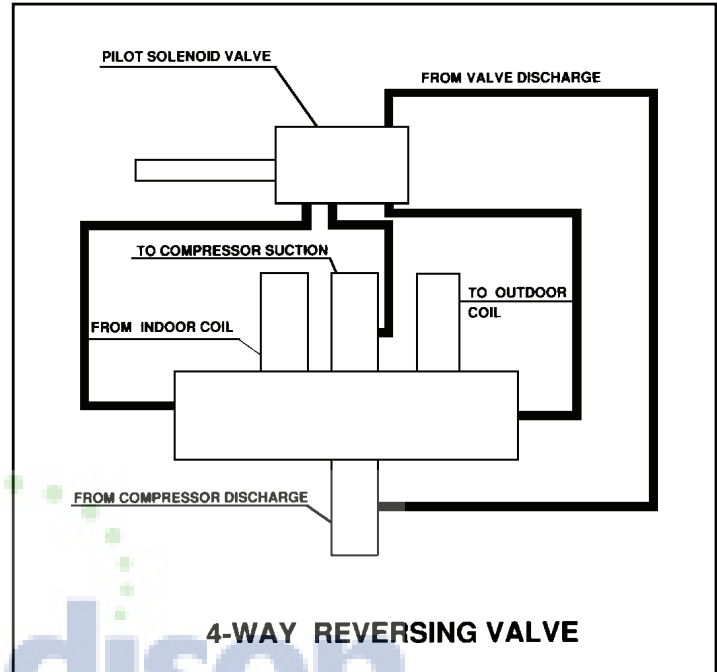

TESTING THE COIL

WARNING



ELECTRIC SHOCK HAZARD

Unplug and/or disconnect all electrical power to the unit before performing inspections, maintenances or service.

Failure to do so could result in electric shock, serious injury or death.

The solenoid coil is an electromagnetic type coil mounted on the reversing valve and is energized during the operation of the compressor in the heating cycle.

1. Turn off high voltage electrical power to unit.
2. Unplug line voltage lead from reversing valve coil.
3. Check for electrical continuity through the coil. If you do not have continuity replace the coil.
4. Check from each lead of coil to the copper liquid line as it leaves the unit or the ground lug. There should be no continuity between either of the coil leads and ground; if there is, coil is grounded and must be replaced.
5. If coil tests okay, reconnect the electrical leads.
6. Make sure coil has been assembled correctly.

NOTE: Do not start unit with solenoid coil removed from valve, or do not remove coil after unit is in operation. This will cause the coil to burn out.

CHECKING THE REVERSING VALVE

NOTE: You must have normal operating pressures before the reversing valve can shift.

WARNING

HIGH PRESSURE HAZARD

Sealed Refrigeration System contains refrigerant and oil under high pressure.

Proper safety procedures must be followed, and proper protective clothing must be worn when working with refrigerants.

Failure to follow these procedures could result in serious injury or death.



Check the operation of the valve by starting the system and switching the operation from "Cooling" to "Heating" and then back to "Cooling". Do not hammer on valve.

Occasionally, the reversing valve may stick in the heating or cooling position or in the mid-position.

When sluggish or stuck in the mid-position, part of the discharge gas from the compressor is directed back to the suction side, resulting in excessively high suction pressure.

Should the valve fail to shift from cooling to heating, block the air flow through the outdoor coil and allow the discharge pressure to build in the system. Then switch the system from heating to cooling.

If the valve is stuck in the heating position, block the air flow through the indoor coil and allow discharge pressure to build in the system. Then switch the system from heating to cooling.

Should the valve fail to shift in either position after increasing the discharge pressure, replace the valve.

Dented or damaged valve body or capillary tubes can prevent the main slide in the valve body from shifting.

If you determine this is the problem, replace the reversing valve.

After all of the previous inspections and checks have been made and determined correct, then perform the "Touch Test" on the reversing valve.

Touch Test in Heating/Cooling Cycle

⚠ WARNING	
	BURN HAZARD Certain unit components operate at temperatures hot enough to cause burns.
	Proper safety procedures must be followed, and proper protective clothing must be worn.
	Failure to follow these procedures could result in minor to moderate injury.

The only definite indications that the slide is in the mid-position is if all three tubes on the suction side of the valve are hot after a few minutes of running time.

NOTE: A condition other than those illustrated above, and on Page 31, indicate that the reversing valve is not shifting properly. Both tubes shown as hot or cool must be the same corresponding temperature.

Procedure For Changing Reversing Valve

⚠ WARNING	
	HIGH PRESSURE HAZARD Sealed Refrigeration System contains refrigerant and oil under high pressure.
	Proper safety procedures must be followed, and proper protective clothing must be worn when working with refrigerants.
	Failure to follow these procedures could result in serious injury or death.

NOTICE	
FIRE HAZARD	
The use of a torch requires extreme care and proper judgment. Follow all safety recommended precautions and protect surrounding areas with fire proof materials. Have a fire extinguisher readily available. Failure to follow this notice could result in moderate to serious property damage.	

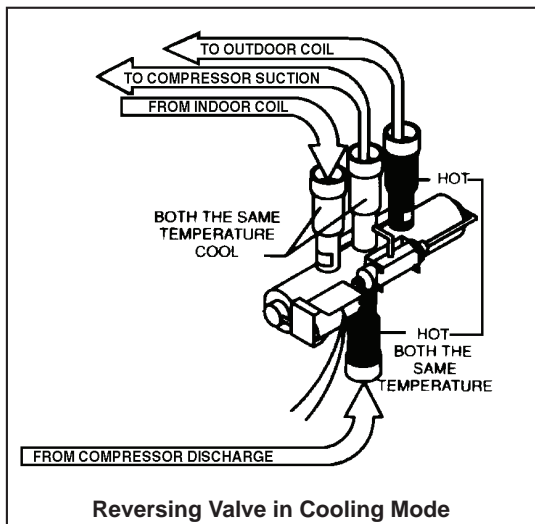
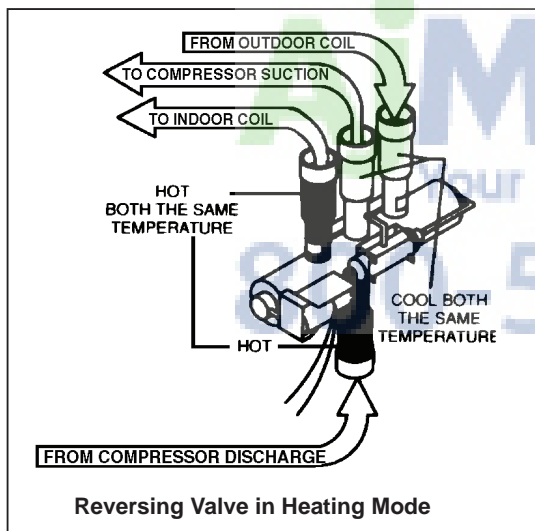

1. Install Process Tubes. Recover refrigerant from sealed system. PROPER HANDLING OF RECOVERED REFRIGERANT ACCORDING TO EPA REGULATIONS IS REQUIRED.
2. Remove solenoid coil from reversing valve. If coil is to be reused, protect from heat while changing valve.
3. Unbraid all lines from reversing valve.
4. Clean all excess braze from all tubing so that they will slip into fittings on new valve.
5. Remove solenoid coil from new valve.

- Protect new valve body from heat while brazing with plastic heat sink (Thermo Trap) or wrap valve body with wet rag.
- Fit all lines into new valve and braze lines into new valve.

⚠ WARNING	
	<p>EXPLOSION HAZARD</p> <p>The use of nitrogen requires a pressure regulator. Follow all safety procedures and wear protective safety clothing etc.</p> <p>Failure to follow proper safety procedures could result in serious injury or death.</p>

- Pressurize sealed system with a combination of R-22 and nitrogen and check for leaks, using a suitable leak detector. Recover refrigerant per EPA guidelines.
- Once the sealed system is leak free, install solenoid coil on new valve and charge the sealed system by weighing in the proper amount and type of refrigerant as shown on rating plate. Crimp the process tubes and solder the ends shut. Do not leave Schrader or piercing valves in the sealed system.

NOTE: When brazing a reversing valve into the system, it is of extreme importance that the temperature of the valve does not exceed 250°F at any time.

Wrap the reversing valve with a large rag saturated with water. "Re-wet" the rag and thoroughly cool the valve after each brazing operation of the four joints involved.

The wet rag around the reversing valve will eliminate conduction of heat to the valve body when brazing the line connection.

COMPRESSOR CHECKS

⚠ WARNING	
	<p>ELECTRIC SHOCK HAZARD</p> <p>Turn off electric power before service or installation. Extreme care must be used, if it becomes necessary to work on equipment with power applied.</p> <p>Failure to do so could result in serious injury or death.</p>

Locked Rotor Voltage (L.R.V.) Test

Locked rotor voltage (L.R.V.) is the actual voltage available at the compressor under a stalled condition.

Single Phase Connections

Disconnect power from unit. Using a voltmeter, attach one lead of the meter to the run "R" terminal on the compressor and the other lead to the common "C" terminal of the compressor. Restore power to unit.

Determine L.R.V.

Start the compressor with the volt meter attached; then stop the unit. Attempt to restart the compressor within a couple of seconds and immediately read the voltage on the meter. The compressor under these conditions will not start and will usually kick out on overload within a few seconds since the pressures in the system will not have had time to equalize. Voltage should be at or above minimum voltage of 197 VAC, as specified on the rating plate. If less than minimum, check for cause of inadequate power supply; i.e., incorrect wire size, loose electrical connections, etc.

Amperage (L.R.A.) Test

The running amperage of the compressor is the most important of these readings. A running amperage higher than that indicated in the performance data indicates that a problem exists mechanically or electrically.

Single Phase Running and L.R.A. Test

NOTE: Consult the specification and performance section for running amperage. The L.R.A. can also be found on the rating plate.

Select the proper amperage scale and clamp the meter probe around the wire to the "C" terminal of the compressor.

Turn on the unit and read the running amperage on the meter. If the compressor does not start, the reading will indicate the locked rotor amperage (L.R.A.).

Overloads

The compressor is equipped with an external overload which senses both motor amperage and winding temperature. High motor temperature or amperage heats the overload causing it to open, breaking the common circuit within the compressor.

Heat generated within the compressor shell, usually due to recycling of the motor, is slow to dissipate. It may take anywhere from a few minutes to several hours for the overload to reset.

Checking the Overload

⚠ WARNING	
	<p>ELECTRIC SHOCK HAZARD</p> <p>Turn off electric power before service or installation. Extreme care must be used, if it becomes necessary to work on equipment with power applied.</p> <p>Failure to do so could result in serious injury or death.</p>

⚠ WARNING



BURN HAZARD

Certain unit components operate at temperatures hot enough to cause burns.

Proper safety procedures must be followed, and proper protective clothing must be worn.

Failure to follow this warning could result in moderate to serious injury.

External Overload

With power off, remove the leads from compressor terminals. If the compressor is hot, allow the overload to cool before starting check. Using an ohmmeter, test continuity across the terminals of the external overload. If you do not have continuity; this indicates that the overload is open and must be replaced.

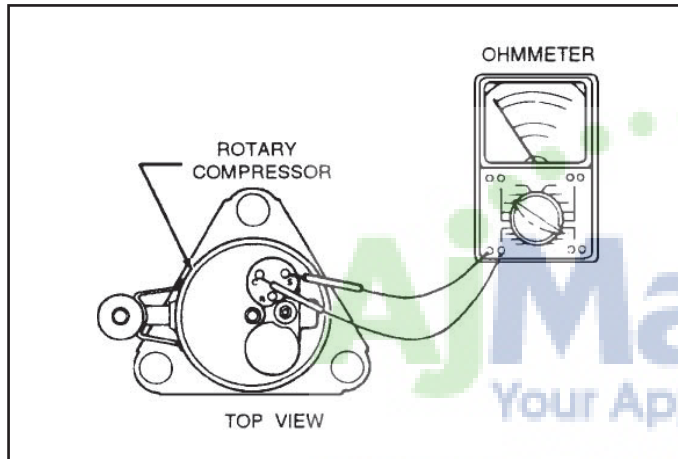

In a single phase PSC compressor motor, the highest value will be from the start to the run connections (“S” to “R”). The next highest resistance is from the start to the common connections (“S” to “C”). The lowest resistance is from the run to common. (“C” to “R”) Before replacing a compressor, check to be sure it is defective.

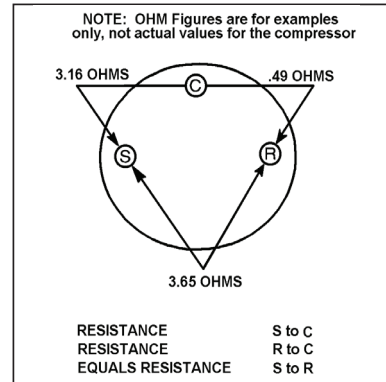

GROUND TEST

Use an ohmmeter set on its highest scale. Touch one lead to the compressor body (clean point of contact as a good connection is a must) and the other probe in turn to each compressor terminal. If a reading is obtained the compressor is grounded and must be replaced.

Check the complete electrical system to the compressor and compressor internal electrical system, check to be certain that compressor is not out on internal overload.

Complete evaluation of the system must be made whenever you suspect the compressor is defective. If the compressor has been operating for sometime, a careful examination must be made to determine why the compressor failed.

Single Phase Resistance Test

⚠ WARNING



ELECTRIC SHOCK HAZARD

Turn off electric power before service or installation. Extreme care must be used, if it becomes necessary to work on equipment with power applied.

Failure to do so could result in serious injury or death.

Remove the leads from the compressor terminals and set the ohmmeter on the lowest scale (R x 1).

Touch the leads of the ohmmeter from terminals common to start (“C” to “S”). Next, touch the leads of the ohmmeter from terminals common to run (“C” to “R”).

Add values “C” to “S” and “C” to “R” together and check resistance from start to run terminals (“S” to “R”). Resistance “S” to “R” should equal the total of “C” to “S” and “C” to “R.”

Many compressor failures are caused by the following conditions:

1. Improper air flow over the evaporator.
2. Overcharged refrigerant system causing liquid to be returned to the compressor.
3. Restricted refrigerant system.
4. Lack of lubrication.
5. Liquid refrigerant returning to compressor causing oil to be washed out of bearings.
6. Noncondensables such as air and moisture in the system. Moisture is extremely destructive to a refrigerant system.

COMPRESSOR REPLACEMENT

Recommended procedure for compressor replacement

⚠ WARNING	
	RISK OF ELECTRIC SHOCK Unplug and/or disconnect all electrical power to the unit before performing inspections, maintenances or service.
	Failure to do so could result in electric shock, serious injury or death.

1. Be certain to perform all necessary electrical and refrigeration tests to be sure the compressor is actually defective before replacing.

⚠ WARNING	
	HIGH PRESSURE HAZARD Sealed Refrigeration System contains refrigerant and oil under high pressure.
	Proper safety procedures must be followed, and proper protective clothing must be worn when working with refrigerants.
	Failure to follow these procedures could result in serious injury or death.

2. Recover all refrigerant from the system through the process tubes. **PROPER HANDLING OF RECOVERED REFRIGERANT ACCORDING TO EPA REGULATIONS IS REQUIRED.** Do not use gauge manifold for this purpose if there has been a burnout. You will contaminate your manifold and hoses. Use a Schrader valve adapter and copper tubing for burnout failures.

⚠ WARNING	
	HIGH TEMPERATURES Extreme care, proper judgment and all safety procedures must be followed when testing, troubleshooting, handling or working around unit while in operation with high temperature components. Wear protective safety aids such as: gloves, clothing etc.
	Failure to do so could result in serious burn injury.

NOTICE	
FIRE HAZARD	
The use of a torch requires extreme care and proper judgment. Follow all safety recommended precautions and protect surrounding areas with fire proof materials. Have a fire extinguisher readily available. Failure to follow this notice could result in moderate to serious property damage.	

3. After all refrigerant has been recovered, disconnect suction and discharge lines from the compressor and remove compressor. Be certain to have both suction and discharge process tubes open to atmosphere.
4. Carefully pour a small amount of oil from the suction stub of the defective compressor into a clean container.
5. Using an acid test kit (one shot or conventional kit), test the oil for acid content according to the instructions with the kit.
6. If any evidence of a burnout is found, no matter how slight, the system will need to be cleaned up following proper procedures.
7. Install the replacement compressor.

⚠ WARNING	
	EXPLOSION HAZARD The use of nitrogen requires a pressure regulator. Follow all safety procedures and wear protective safety clothing etc.
	Failure to follow proper safety procedures result in serious injury or death.

8. Pressurize with a combination of R-410A and nitrogen and leak test all connections with leak detector capable of detecting HFC (Hydrofluorocarbon) refrigerant. Recover refrigerant/nitrogen mixture and repair any leaks found. Repeat Step 8 to insure no more leaks are present.
9. Evacuate the system with a good vacuum pump capable of a final vacuum of 200 microns or less. The system should be evacuated through both liquid line and suction line gauge ports. While the unit is being evacuated, seal all openings on the defective compressor.

⚠ CAUTION	
	FREEZE HAZARD Proper safety procedures must be followed, and proper protective clothing must be worn when working with liquid refrigerant.
	Failure to follow these procedures could result in minor to moderate injury.

10. Recharge the system with the correct amount of refrigerant. The proper refrigerant charge will be found on the unit rating plate. The use of an accurate measuring device, such as a charging cylinder, electronic scales or similar device is necessary.

NOTICE	
NEVER , under any circumstances, charge a rotary compressor through the LOW side. Doing so would cause permanent damage to the new compressor.	

SPECIAL PROCEDURE IN THE CASE OF MOTOR COMPRESSOR BURNOUT

⚠ WARNING	
	ELECTRIC SHOCK HAZARD Turn off electric power before service or installation. Failure to do so may result in personal injury, or death.

⚠ WARNING	
	HIGH PRESSURE HAZARD Sealed Refrigeration System contains refrigerant and oil under high pressure. Proper safety procedures must be followed, and proper protective clothing must be worn when working with refrigerants. Failure to follow these procedures could result in serious injury or death.

⚠ WARNING	
	EXPLOSION HAZARD The use of nitrogen requires a pressure regulator. Follow all safety procedures and wear protective safety clothing etc. Failure to follow proper safety procedures result in serious injury or death.

1. Recover all refrigerant and oil from the system.
2. Remove compressor, capillary tube and filter drier from the system.
3. Flush evaporator condenser and all connecting tubing with dry nitrogen or equivalent. Use approved flushing agent to remove all contamination from system. Inspect suction and discharge line for carbon deposits. Remove and clean if necessary. Ensure all acid is neutralized.
4. Reassemble the system, including new drier strainer and capillary tube.
5. Proceed with step 8-10 on previous page.

ROUTINE MAINTENANCE

⚠ WARNING	
	ELECTRICAL SHOCK HAZARD! Turn off electrical power before service or installation. All electrical connections and wiring MUST be installed by a qualified electrician and conform to the National Code and all local codes which have jurisdiction. Failure to do so can result in property damage, personal injury and/or death.

To ensure proper unit operation and life expectancy, the following maintenance procedures should be performed on a regular basis

1. Air Filter

To ensure proper unit operation, the air filters should be cleaned at least monthly, and more frequently if conditions warrant. The unit must be turned off before the filters are cleaned.

To remove the air filters, grasp the top of the filter and lift out of the front cabinet. Reverse the procedure to reinstall the filters.

Clean the filters with a mild detergent in warm water, and allow them to dry thoroughly before reinstalling.

2. Coils & Chassis

NOTE: Do not use a caustic coil cleaning agent on coils or base pan. Use a biodegradable cleaning agent and degreaser. The use of harsh cleaning materials may lead to deterioration of the aluminum fins or the coil end plates.

The indoor coil and outdoor coils and base pan should be inspected periodically (annually or semi-annually) and cleaned of all debris (lint, dirt, leaves, paper, etc.) as necessary. Under extreme conditions, more frequent cleaning may be required. Clean the coils and base pan with a soft brush and compressed air or vacuum. A pressure washer may also be used, however, you must be careful not to bend the aluminum fin pack. Use a sweeping up and down motion in the direction of the vertical aluminum fin pack when pressure cleaning coils.

Note: It is extremely important to insure that none of the electrical and/or electronic parts of the unit get wet. Be sure to cover all electrical components to protect them from water or spray.

3. Decorative Front

The decorative front and discharge air grille may be cleaned with a mild soap or detergent. Do NOT use solvents or hydrocarbon based cleaners such as acetone, naphtha, gasoline, benzene, etc., to clean the decorative front or air discharge grilles.

Use a damp (not wet) cloth when cleaning the control area to prevent water from entering the unit, and possibly damaging the electronic control

4. Fan Motor & Compressor

The fan motor & compressor and are permanently lubricated, and require no additional lubrication.

5. Wall Sleeve

Inspect the inside of the wall sleeve and drain system periodically (annually or semi-annually) and clean as required. Under extreme conditions, more frequent cleaning may be necessary. Clean both of these areas with an antibacterial and antifungal cleaner. Rinse both items thoroughly with water and ensure that the drain outlets are operating properly.

TROUBLESHOOTING CHART - COOLING

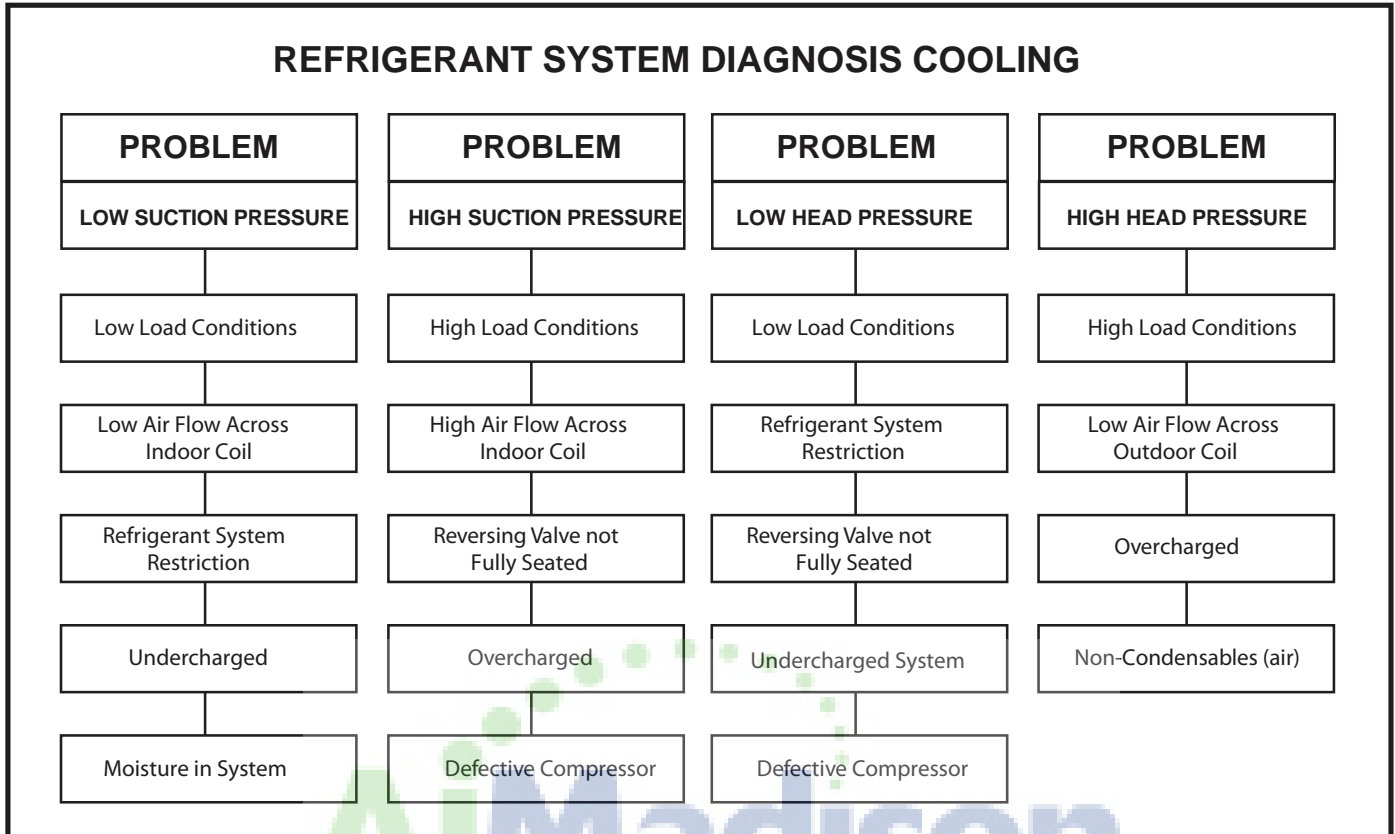

TROUBLESHOOTING CHART - HEATING

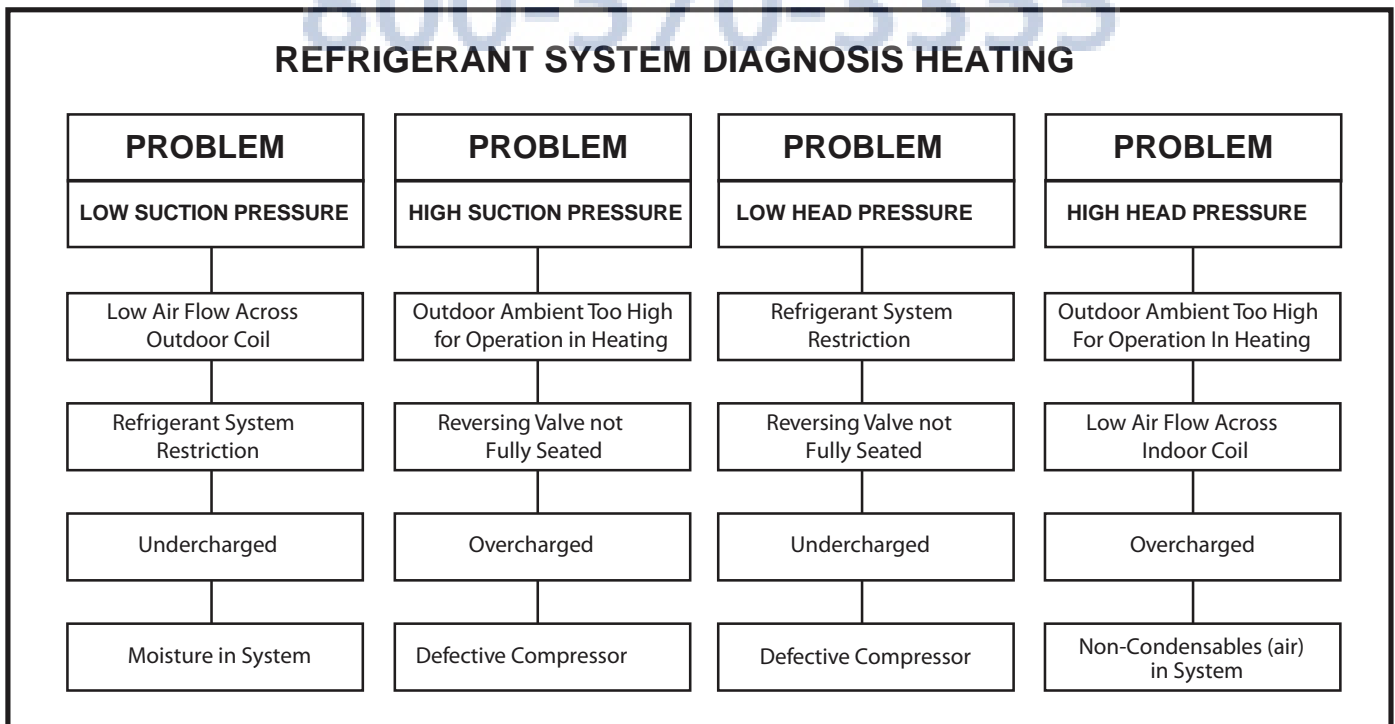

ELECTRICAL TROUBLESHOOTING CHART - HEAT PUMP

⚠ WARNING



ELECTRIC SHOCK HAZARD

Turn off electric power before service or installation.

Extreme care must be used, if it becomes necessary to work on equipment with power applied.

Failure to do so could result in serious injury or death.

⚠ CAUTION



BURN HAZARD

Certain unit components operate at temperatures hot enough to cause burns.

Proper safety procedures must be followed, and proper protective clothing must be worn.

Failure to do so could result in minor to moderate injury.

HEAT PUMP

SYSTEM COOLS WHEN HEATING IS DESIRED.

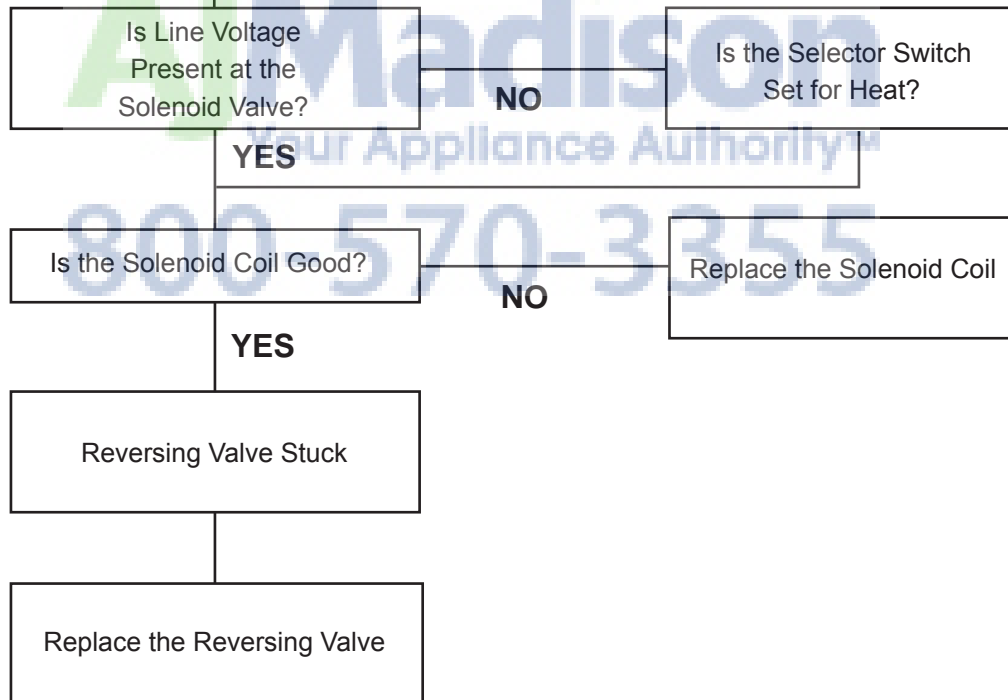

WIRING DIAGRAM INDEX

Model	Wiring Diagram	Page	Model	Wiring Diagram	Page
PDE07			PDH07		
PDE07K2SE-A	921-401-00	37	PDH07K2SE-A	921-402-00	38
PDE07K3SE-A	921-401-00	37	PDH07K3SE-A	921-402-00	38
PDE07R2SE-A	921-401-00	37	PDH07R2SE-A	921-402-00	38
PDE07R3SE-A	921-401-00	37	PDH07R3SE-A	921-402-00	38
PDE09			PDH09		
PDE09K0SE-A	921-401-00	37	PDH09K2SE-A	921-402-00	38
PDE09K2SE-A	921-401-00	37	PDH09K3SE-A	921-402-00	38
PDE09K3SE-A	921-401-00	37	PDH09R2SE-A	921-402-00	38
PDE09R2SE-A	921-401-00	37	PDH09R3SE-A	921-402-00	38
PDE09R3SE-A	921-401-00	37			
PDE12			PDH12		
PDE12K0SE-A	921-401-00	37	PDH12K2SE-A	921-402-00	38
PDE12K2SE-A	921-401-00	37	PDH12K3SE-A	921-402-00	38
PDE12K3SE-A	921-401-00	37	PDH12K5SE-A	921-402-00	38
PDE12K5SE-A	921-401-00	37	PDH12R2SE-A	921-402-00	38
PDE12R2SE-A	921-401-00	37	PDH12R3SE-A	921-402-00	38
PDE12R3SE-A	921-401-00	37	PDH12R5SE-A	921-402-00	38
PDE12R5SE-A	921-401-00	37			
PDE15			PDH15		
PDE15K0SE-A	921-401-00	37	PDH15K3SE-A	921-402-00	38
PDE15K3SE-A	921-401-00	37	PDH15K5SE-A	921-402-00	38
PDE15K5SE-A	921-401-00	37	PDH15R3SE-A	921-402-00	38
PDE15R3SE-A	921-401-00	37	PDH15R5SE-A	921-402-00	38
PDE15R5SE-A	921-401-00	37			



 You Appliance Authority™

800-570-3355

WIRING DIAGRAM COOL WITH ELECTRIC HEAT

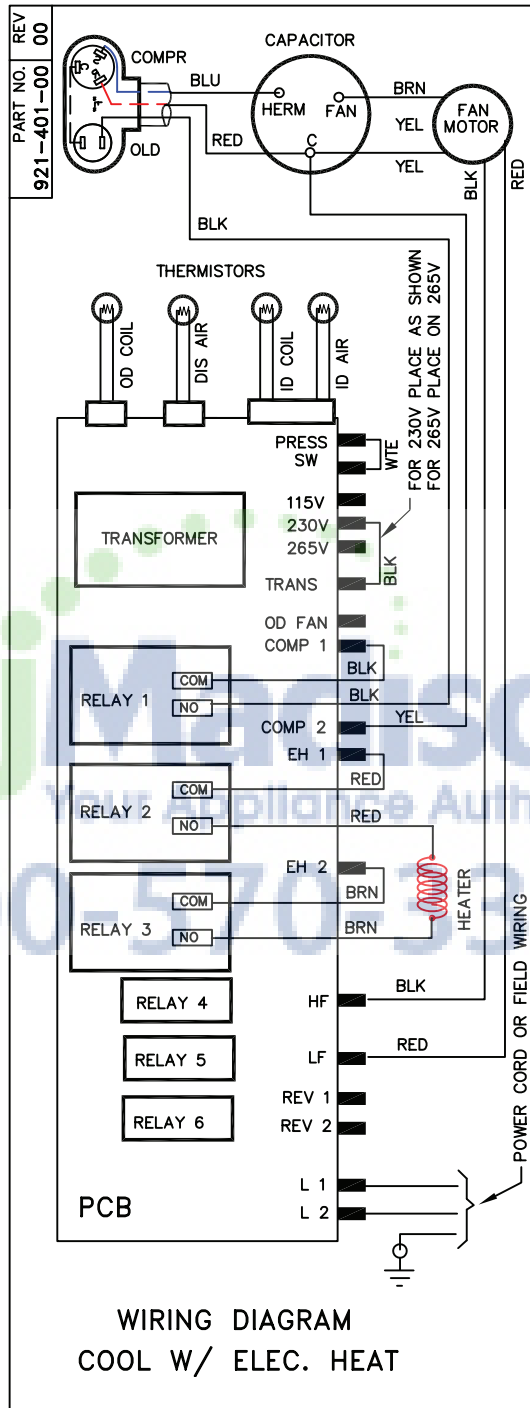

WIRING DIAGRAM HEAT PUMP WITH ELECTRIC HEAT

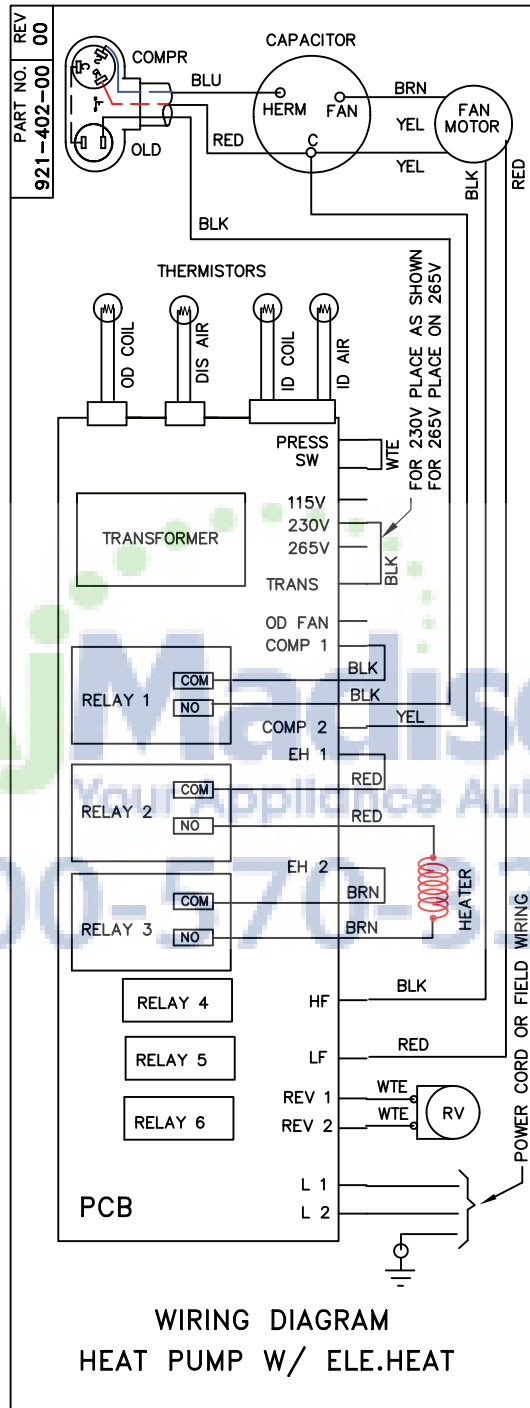

REMOTE THERMOSTAT WIRING DIAGRAM

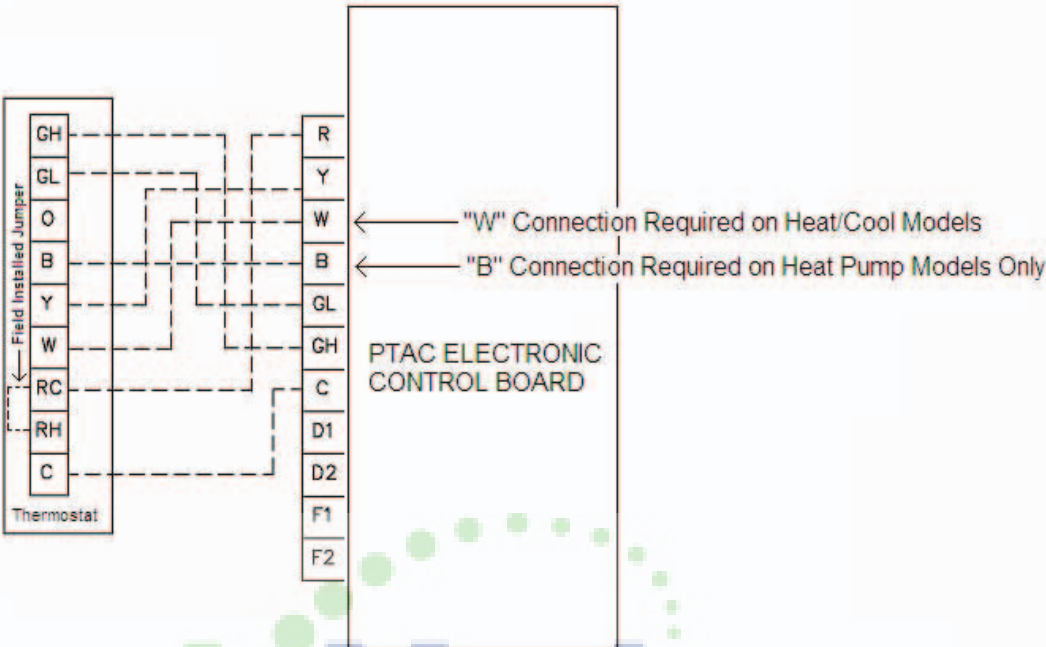

AjMadison
Your Appliance Authority™
800-570-3355

TECHNICAL SERVICE DATA

SERVICE DATA Cooling ¹	ELECTRICAL RATINGS		INDOOR COIL TEMPERATURE ° F		OUTDOOR COIL TEMPERATURE ° F	Discharge Line Temperature ° F	Suction Line Temperature ° F	Super Heat ° F	Sub-Cooling ° F	OPERATING PRESSURES		Refrigerant Charge R-410A - Oz.
	Voltage	Amps	Supply Air	Temperature Drop Δ						Suction	Discharge	
PDE07K*SE	230/208	3.3	53	27	120	173	72	15	24	144	400	42.0
PDE09K*SE	230/208	3.6	52	28	117	155	55	15	21	142	420	36.0
PDE12K*SE	230/208	5.5	53	27	123	163	60	11	18	144	439	33.0
PDE15K*SE	230/208	7.0	49	31	133	184	61	11	31	133	489	48.0
PDE07R*SE	265	2.9	53	27	115	150	65	12	23	158	390	35.0
PDE09R*SE	265	3.3	55	25	119	165	65	14	27	138	410	35.0
PDE12R*SE	265	4.6	52	28	126	167	55	7	22	140	440	36.0
PDE15R*SE	265	6.4	49	31	134	166	55	13	26	132	470	42.0
PDH07K*SE	230/208	3.2	55	25	117	165	71	18	19	151	404	37.0
PDH09K*SE	230/208	3.6	53	27	120	165	67	18	25	140	420	35.0
PDH12K*SE	230/208	5.4	53	27	125	177	65	14	22	140	460	42.0
PDH15K*SE	230/208	6.7	53	27	135	195	66	17	35	136	510	39.0
PDH07R*SE	265	2.8	55	25	118	168	65	15	22	155	400	38.0
PDH09R*SE	265	3.3	55	25	118	166	70	14	20	145	420	33.0
PDH12R*SE	265	5.2	53	27	129	170	67	14	25	145	470	40.0
PDH15R*SE	265	6.3	50	30	130	183	60	10	30	140	515	42.0

¹Test Conditions: 80° F, Room Air Temperature with 50% Relative Humidity, and 95° F, Outdoor Air Temperature with 40% Relative Humidity

*Denotes Heater KW - Number Varies



TECHNICAL SUPPORT CONTACT INFORMATION



F R I E D R I C H

FRIEDRICH AIR CONDITIONING CO.

Post Office Box 1540 · San Antonio, Texas 78295-1540
4200 N. Pan Am Expressway · San Antonio, Texas 78218-5212
(210) 357-4400 · 1-800-541-6645 · FAX (210) 357-4490
www.friedrich.com

Printed in the U.S.A.



F R I E D R I C H

FRIEDRICH AIR CONDITIONING CO.

Post Office Box 1540 · San Antonio, Texas 78295-1540
4200 N. Pan Am Expressway · San Antonio, Texas 78218-5212
(210) 357-4400 · FAX (210) 357-4490
www.friedrich.com

Printed in the U.S.A.

PD-ServMan-E (1-10)