

Installation Instructions

WALL SLEEVE

For Use With Packaged Terminal Units

Please read these instructions completely before attempting installation.

NOTE: These instructions apply to installation of the wall sleeve only through walls structurally adequate to support the unit (i.e. sleeve, chassis, accessories.) If wall is not structurally adequate, a subbase or other means of support **MUST** be made.

Figure 1. Typical Wall Sleeve Installation

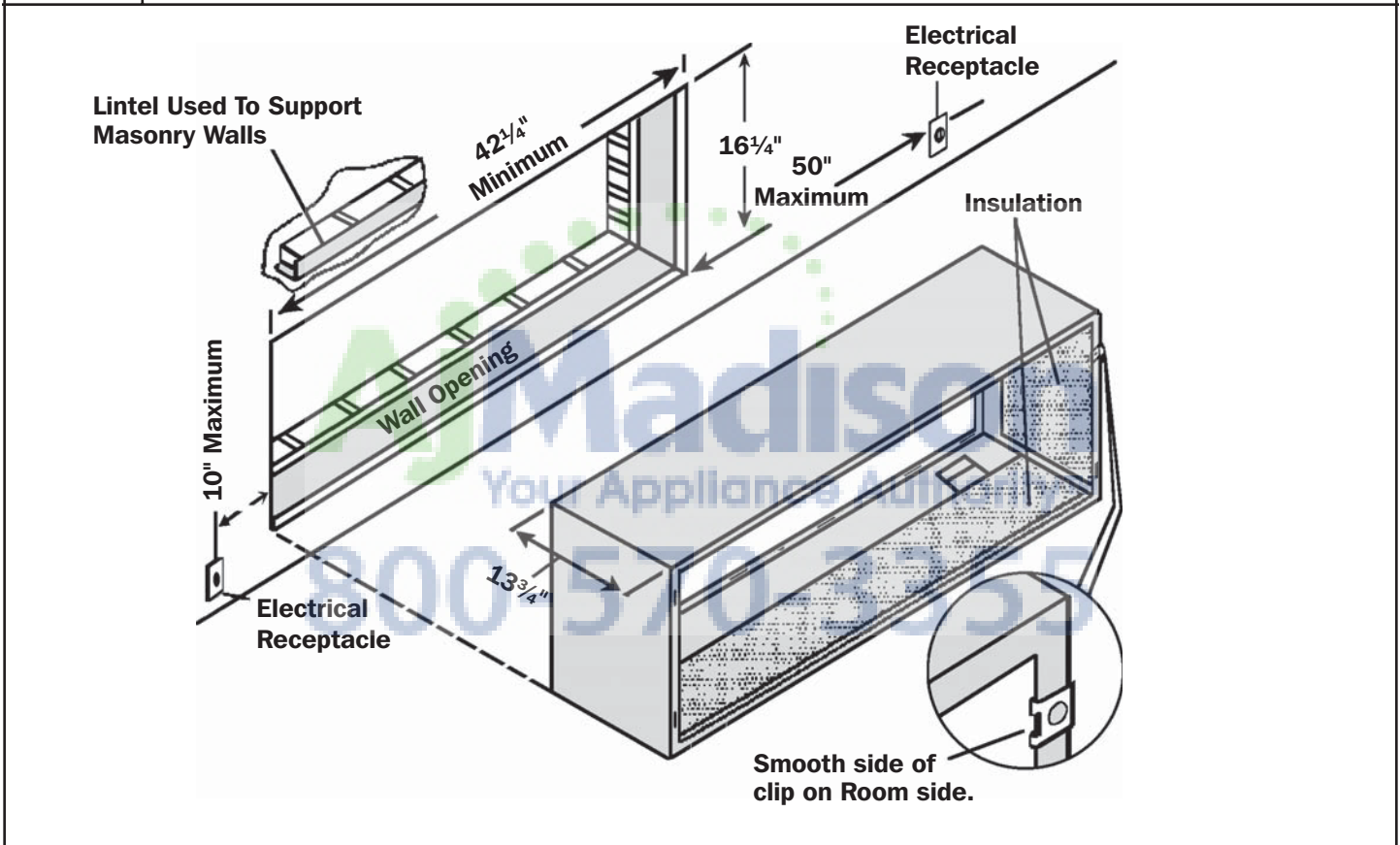

WARNING

Electrical shock hazard.

Turn OFF electric power at fuse box or service panel before making any electrical connections and ensure a proper ground connection is made before connecting line voltage.

Failure to do so can result in property damage, personal injury and/or death.

Wall Opening

Refer to **Figures 1 and 2** for proper dimensions and location of wall opening and placement of electrical receptacle.

SECTION I

Drain Kit

A field supplied condensate drain kit is required for total elimination of cooling or heat pump condensate.

When installing a condensate drain kit, (either internal or external drain), it is recommended that installation of the drain kit be completed before installing the wall sleeve. Instructions for drain kit installation are shipped with the drain kit.

Wall Structure

A subbase or other means of support **MUST** be used if sleeve projects more than 8" into room. Refer to subbase installation instructions for additional information.

Sleeve Installation

For Deep Wall Installation See Section II

The following instructions apply **ONLY** to walls less than 1 1/4" in depth.

1. From inside the building, position wall sleeve in opening and push through the wall so it protrudes at least 1/4" on the outside, note **Figure 2**.
2. Position the wall sleeve so that it is positioned with a slight tilt towards the outside to facilitate condensate drainage. It should be level side-to-side. **DO NOT allow any pitch toward the inside.**

3. Drill two 3/16" holes through each side of the sleeve approximately 4" from top and 4" from bottom of sleeve. Screw four #10 x 1" screws (included) or appropriate fasteners for your installation, through holes in sides of opening.

NOTE: Do **NOT** put any screws or drill any holes in the bottom of wall sleeve, unless required by the installation of a PXDR10 Condensate Drain Kit.

4. Apply sealant around the wall sleeve where it projects through the inside and outside wall surfaces. Apply sealant to screw heads or tops of fasteners used in Step #3.

NOTE: When sealing sleeve on outside of building, be careful **NOT** to let sealant block the two condensate drain holes or the four overflow slots at the bottom flange of the sleeve.

5. If chassis and exterior louver are to be installed later, leave the weatherboard and center support in place, otherwise remove and dispose of them.

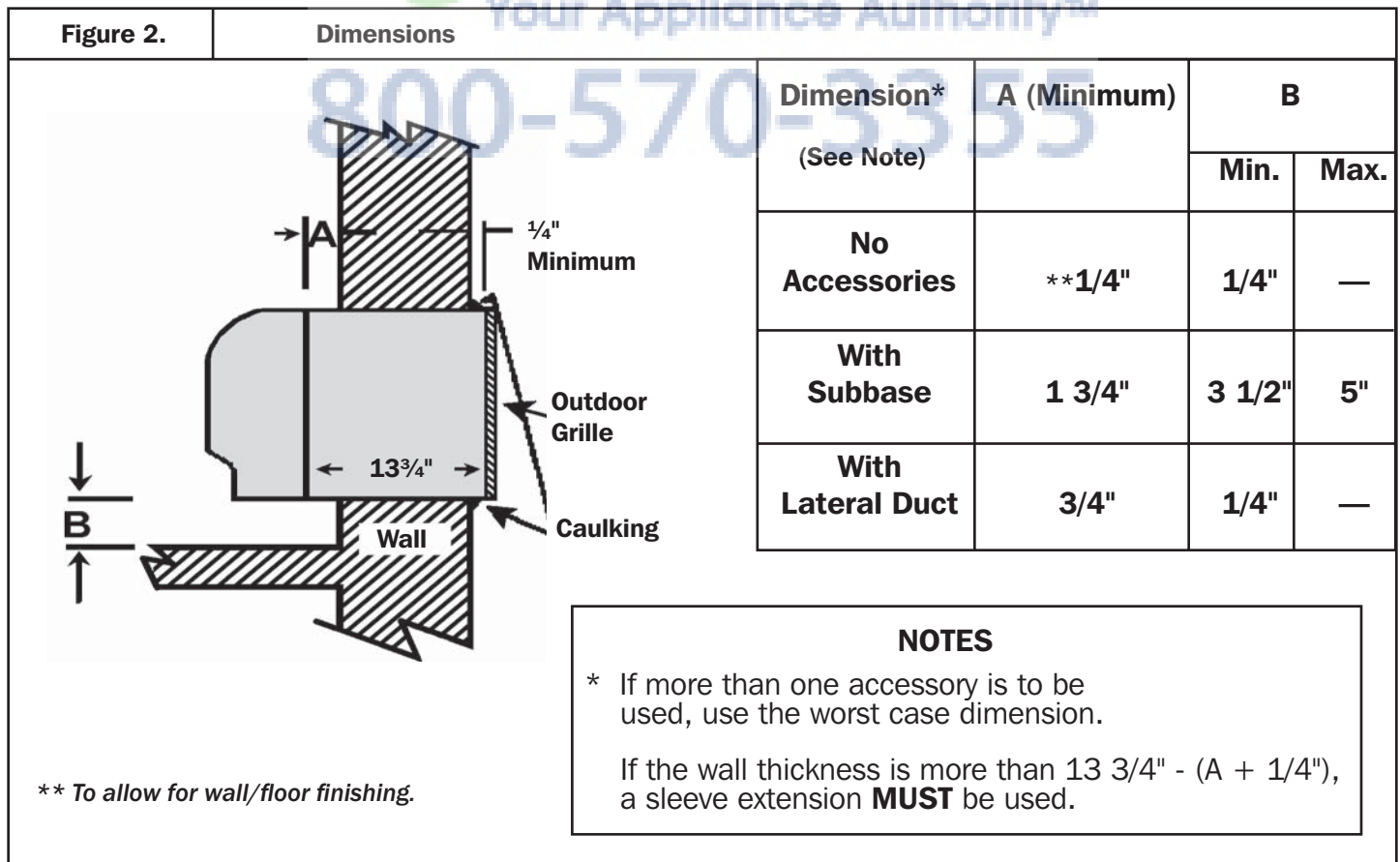
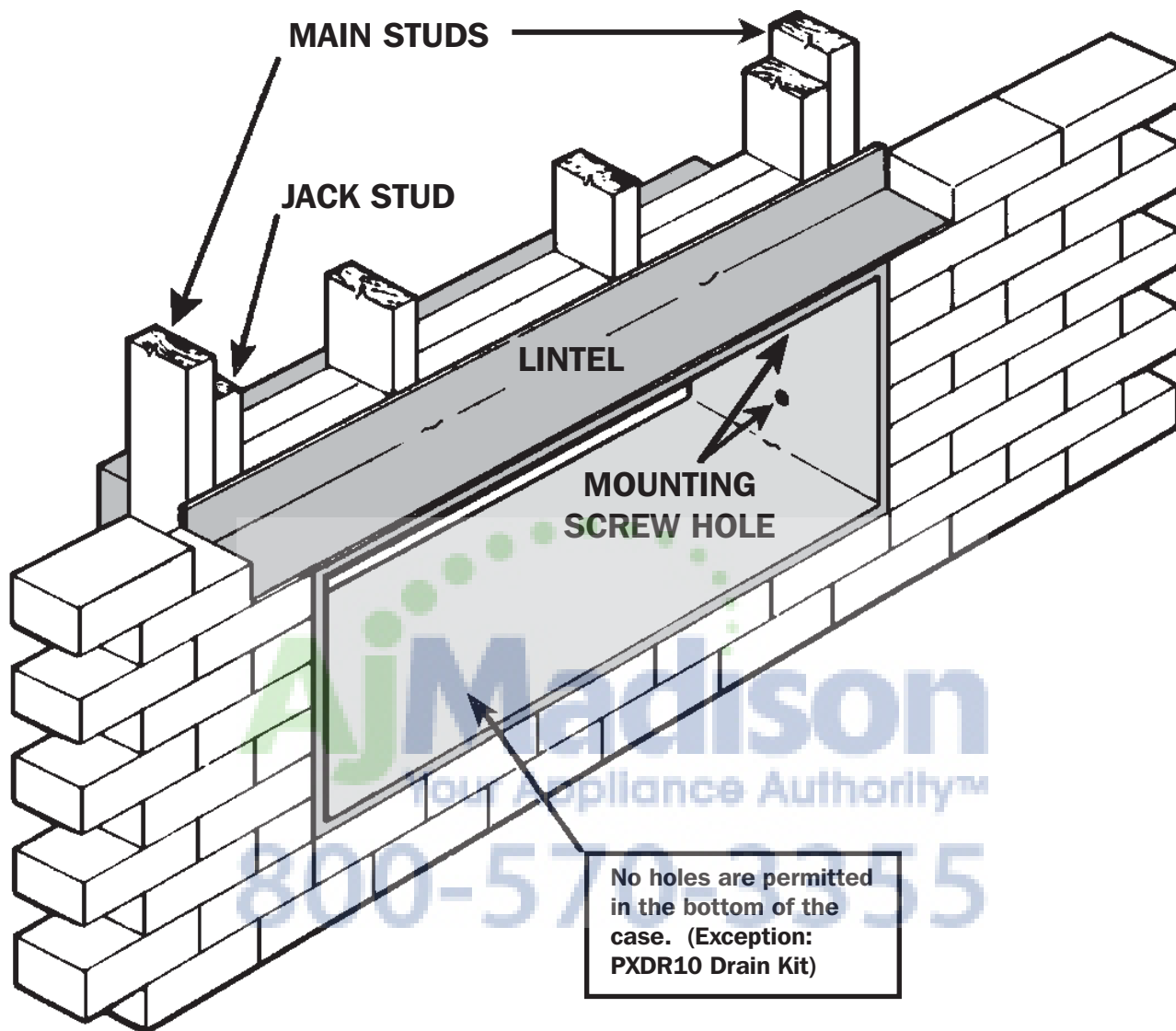

Figure 3.

Lintel Installation



Note the use of a lintel under the first course of bricks above the wall sleeve. Do not use the wall sleeve as a lintel. The mounting screw holes shown are to be made by the installer.

6. Provide a support lintel if the wall sleeve is installed in a concrete or masonry wall. (See Figure 3)

SECTION II

Deep Wall Installation

If wall is thicker than allowed in the notes in **Figure 2**, a sheet metal wall sleeve extension and flashing **MUST** be used. See **Figure 4** for guidelines to use in fabricating a wall sleeve extension.

Field Fabricating A Sleeve Extension

The Following points **MUST** be considered when designing a wall sleeve extension.

1. Provision must be made to direct excess condensate from the back of the wall sleeve to the outside of the building.
2. Air baffles must be mounted to properly direct air flow from the condenser.
3. Wall Sleeve Extension design must allow for the proper mounting of the louvers.
4. Caulking of all potential sites where condensate or external water could infiltrate into building is required.
5. Seal strips must be attached to the outside edge of the vertical baffles.

6. Condensate notches are clear of sealant so condensate flows freely into extension.

NOTE: Improper fabrication of a wall sleeve extension will impair PTAC performance. Regardless of your final extended wall sleeve design, provision **MUST** be made for proper direction of air flow and condensate.

Extension Installation

Size wall sleeve extension to fit frame opening. Secure it to the wall sleeve before installing in the wall. Refer to **Figure 4** for a guide for fabrication of a condensate drip panel. Panel **MUST** extend the full depth of the wall sleeve **and** the wall sleeve extension. Pay particular care in sealing and caulking the panel where it makes contact with the wall sleeve (see **Figure 4**.) After installation in the wall, secure with fasteners through the sides. Seal around the sleeve extension with exterior caulking. Using a good grade of silicone sealant, seal all exposed screw heads. When installation is complete, outside louver may be attached to wall sleeve extension.

