

Professional 2 PS2X110-18 Stainless Steel

Franke's Professional 2, the second generation of this hard-working sink, features an updated silk stainless finish and modern lines that offer enduring beauty for years. Made of 16 gauge, commercial-grade T304 stainless steel and available in a variety of size and configuration options, it's the perfect partner for the serious home chef. The rear offset drain maximizes the usable bottom surface of the bowl while also creating extra cabinet space beneath the sink. The thoughtful flush drain design functions like a traditional drain while maintaining the even surface of the basin. Add custom accessories such as a cutting board, colander or roller mat which are perfectly sized for the Professional 2 series sinks.

Product Picture



Technical Drawing

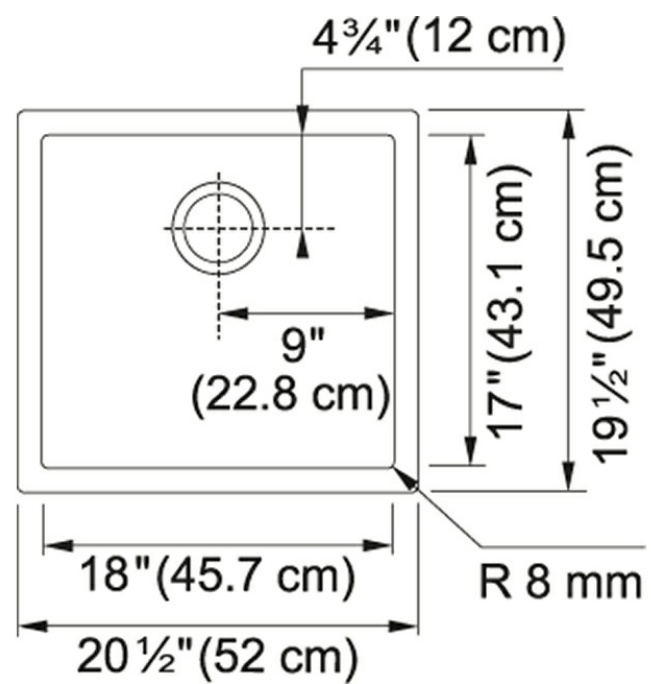

Product Dimensions

Length overall	20 1/2"
Width overall	19 1/2"
Length of large bowl	18"
Width of large bowl	16 15/16"
Depth of large bowl	10"
Minimum Cabinet Size	24"

General Information

Type of Material	16 Gauge Stainless Steel
Number of Bowls	1
Installation Clips	Yes
Cut-Out Template	Yes
Where to buy	Showroom

Article Numbers

FUN#	122.0530.830
US Part Number	PS2X110-18

