

# Vent-A-Hood

## INSTALLATION INSTRUCTIONS

### WALL MOUNT RANGE HOOD

**WARNING - TO REDUCE THE RISK OF FIRE, ELECTRIC SHOCK, OR INJURY TO PERSONS, OBSERVE THE FOLLOWING:**

- A. Installation Work and Electrical Wiring Must Be Done By Qualified Person(s) In Accordance With All Applicable Codes And Standards, Including Fire-Rated Construction.
- B. When cutting or drilling into wall or ceiling, do not damage electrical wiring and other hidden utilities.
- C. Ducted fans must always be vented to the outdoors.
- D. Sufficient air is needed for proper combustion and exhausting of gases through the flue (chimney) of fuel burning equipment to prevent back drafting. Follow the heating equipment manufacturer's guideline and safety standards such as those published by the National Fire Protection Association (NFPA), and the American Society for Heating, Refrigeration and Air Conditioning Engineers (ASHRAE), and local code authorities.

**WARNING - TO REDUCE THE RISK OF FIRE, USE ONLY METAL DUCTWORK.**

## Read and Save These Instructions All Hoods Should Be Installed By A Qualified Installer

### Step 1. — Cut vent hole in ceiling or furrdown.

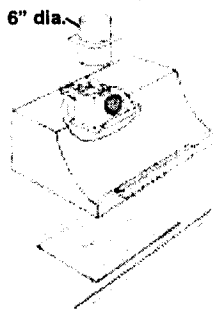

**A. Model B100** — Mark area to be cut as per dimensions on sketch below. Allow area for motor cooling vents. (Motors are cooled from above). Special offset transition to centerline is available.

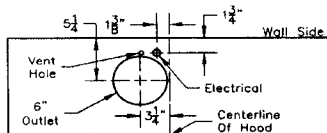

Top View—B100 Single Blower

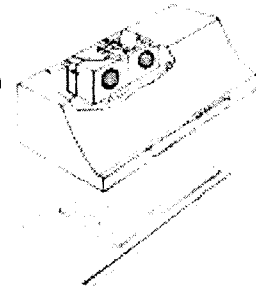

**B. Model B200** — Mark opening to cut out area as per dimensions on sketch below. Motors are cooled from above so be sure area is large enough for motor cooling vents.

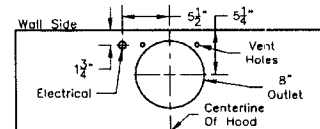

Top View—B200 Dual Blower

### Step 2. — Remove wood mounting strip. Mount to wall.

Remove wood mounting strips from channel on back side of hood. (Wood strip attached with Phillips head screws.)

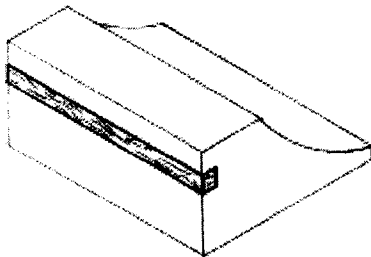

Nail or screw mounting strip to wall in proper position and attach firmly to wall studs. Hang hood canopy on wood strip and attach with Phillips head screws provided. If more support is needed for larger hoods, attach lower part of canopy to wall with lag bolts or to studs. Canopy can also be attached to side cabinets or walls if necessary.

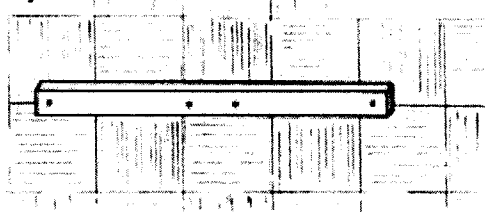

### Step 3. — Connect ducting.

**A. Model B100:** 6" duct or the equivalent must be installed throughout.

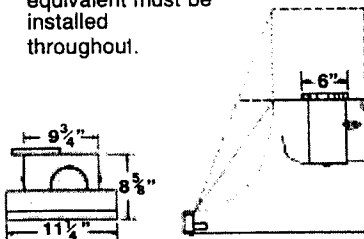

Blower	Minimum Round Duct Size	Square Inches
B100 Single 300 CFM	6" (or equivalent)	28
B200 Dual 600 CFM	8" (or equivalent)	50

Each single or dual blower in hood must be vented and connected separately. Do not restrict ducting anywhere including roof jacks or wall louvers. Don't make sharp turns with ducting. Make gradual turns or 45° angles.

**B. Model B200:** 8" round duct or the equivalent must be installed throughout.

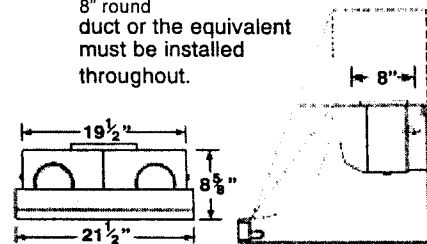

**Turn Page For More Instructions**

### Step 4. — Connect electrical.

Follow label instructions and remove motor plate. Unplug motor and remove, being careful to not damage blower wheel. Connect electrical, black to black, white to white and ground to lug provided. In cluster blower hoods (hoods with more than one dual blower) separate electrical connections are necessary (one for each dual blower). Replace motor(s) and don't forget to plug them back in. Replace blower front and be sure it is secured properly and blower wheel(s) turn freely. Model B100, 1.7 Amps. Model B200, 3.4 Amps. Hoods with heat lamps and/or halogen lamps, 8.0 Amps.

### Observe All Governing Codes and Ordinances

**Caution:** to reduce the risk of fire or electrical shock, do not use this fan with any solid state speed control device.

## Methods of Ducting Your Vent-A-Hood

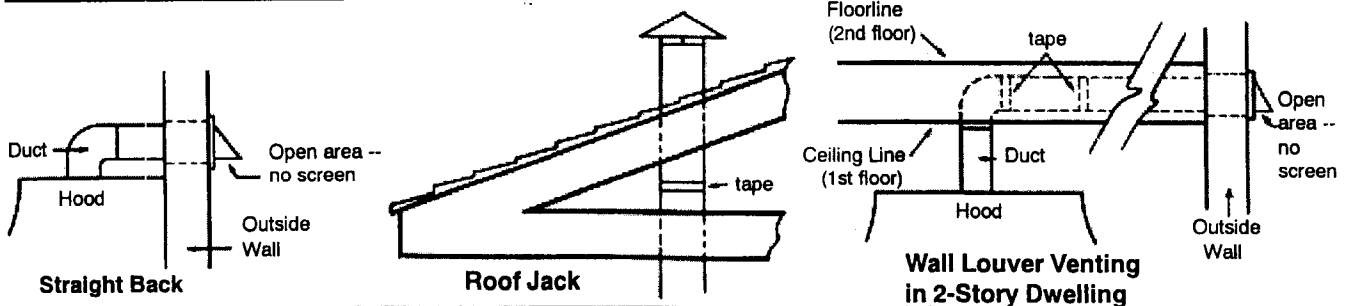

## Venting Configurations

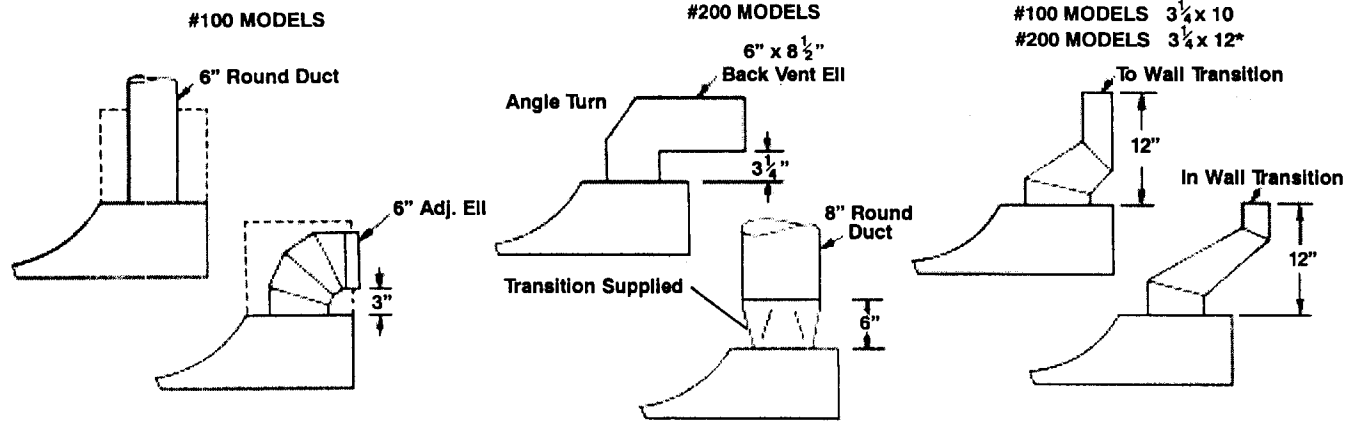

## Venting Materials Available from Vent-A-Hood

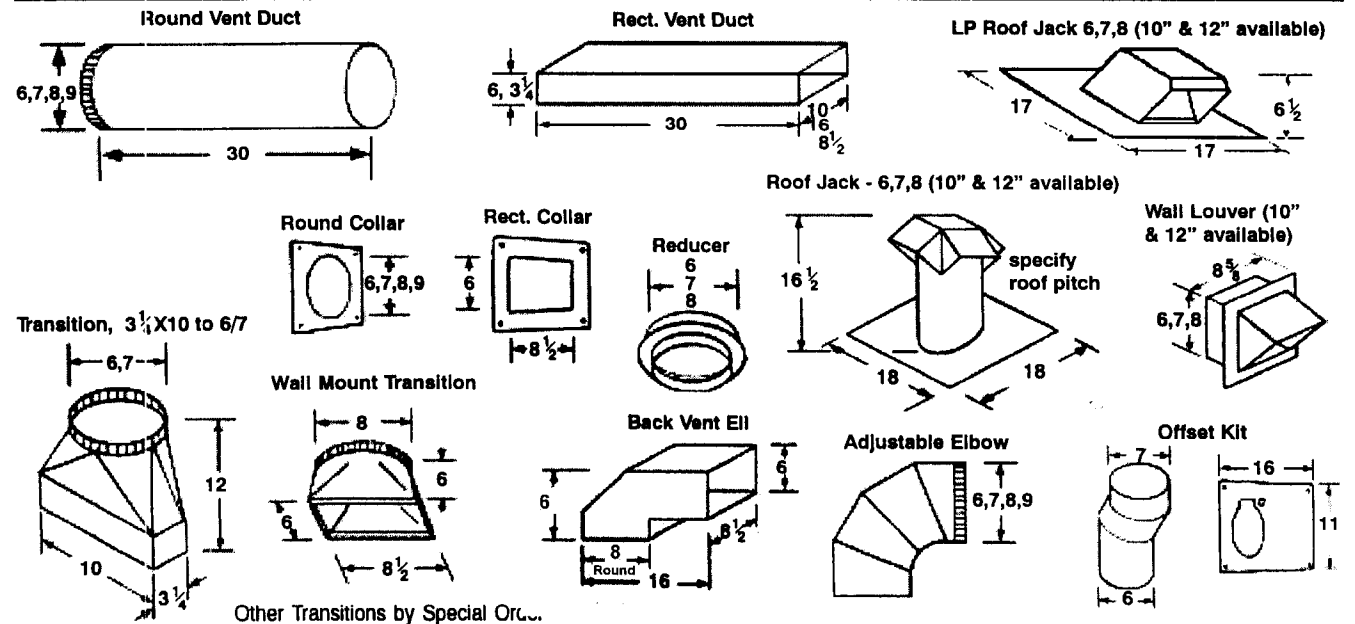

*Vent-A-Hood*

1000 N. Greenville Ave. • P.O. Box 830426 • Richardson, TX 75083 • (972) 235-5201

Revised 06/05