



Madison
Your Appliance Authority™
800-570-3355

Vent Hood

THE VENTHOOD DIFFERENCE

1

GREASE EXTRACTION

OUR PREMIUM
MAGIC LUNG® BLOWER

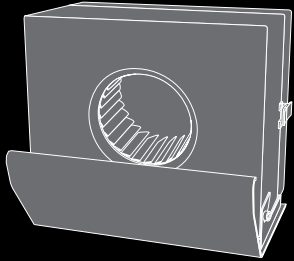

CONSTANT 99%
CENTRIFUGAL
GREASE EXTRACTION

LABORATORY TESTING OF COMPETITIVE UNITS SHOWS THAT ONLY ABOUT 30% OF THE GREASE IS COLLECTED IN THE FILTER DURING TYPICAL RESIDENTIAL COOKING.

SCREEN/BAFFLE FILTER

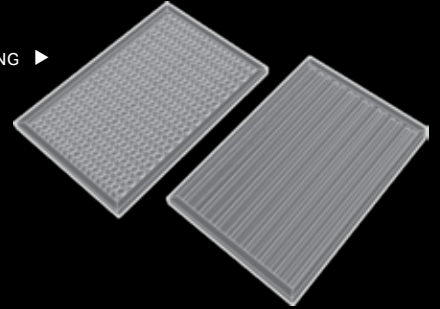

5% TO 60% VARIABLE
GREASE EXTRACTION

MAGIC LUNG® VS OTHER BRANDS

THE PATENTED MAGIC LUNG® CENTRIFUGAL GREASE EXTRACTOR COLLECTS 99% OF THE GREASE 100% OF THE TIME.

2

QUIET & POWERFUL

THE QUIETEST VENTILATION
AVAILABLE

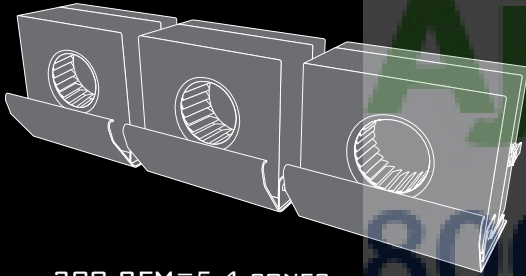

300 CFM=5.4 SONES
600 CFM=6.5 SONES
900 CFM=6.3 SONES
1200 CFM=6.6 SONES

VARIABLE SPEED BLOWERS BECOME LOUDER AND LOUDER AS CFM INCREASES.

NOISY VARIABLE
SPEED BLOWER

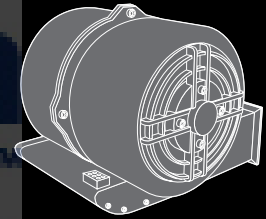

300 CFM=6.0 SONES
600 CFM=9.0 SONES
900 CFM=12.0 SONES
1200 CFM=15.0 SONES

MAGIC LUNG® VS OTHER BRANDS

EACH MAGIC LUNG® BLOWER SUPPLIES 300 CFM OF AIR FLOW—COMBINING MULTIPLE BLOWERS WILL MEET ANY AIR FLOW REQUIREMENT WITHOUT INCREASING THE NOISE LEVEL.

3

EFFICIENT

COLLECTION

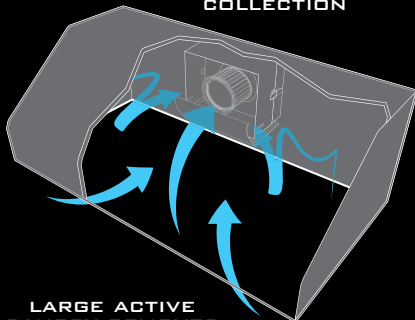

LARGE ACTIVE
CANOPY REMOVES
CONTAMINANTS

FILTERS OBSTRUCT AIR FLOW AND SPOIL THE COLLECTOR PROPERTIES OF THE CANOPY.

BARRIER

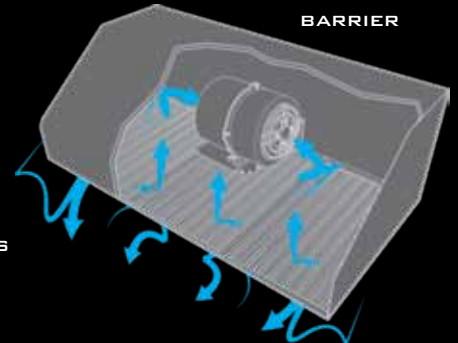

CLOSED CANOPY
RESTRICTS AIR FLOW

MAGIC LUNG® VS OTHER BRANDS

A RANGE HOOD EQUIPPED WITH THE MAGIC LUNG® BLOWER SYSTEM IS A WIDE OPEN, ACTIVE COLLECTOR THAT INVITES CONTAMINANTS IN. A PROPER COLLECTOR IS THE MOST CRITICAL ELEMENT FOR GOOD COOKING VENTILATION AND REQUIRES 1/3 LESS AIR FLOW THAN A FILTER-STYLE RANGE HOOD.

4

NEW, SIMPLE SLIDE-OFF GREASE TRAY (OPTIONAL)

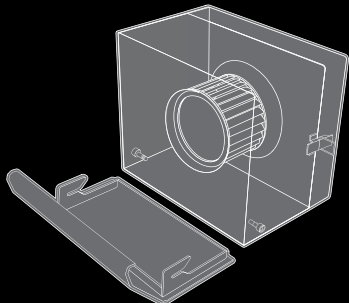

BLOWER HOUSING SNAPS APART FOR FAST CLEANING

EASY TO CLEAN

CLEANING THE GREASE FROM BEHIND THE FILTER IS NEARLY IMPOSSIBLE. ACCESS IS LIMITED BY COMPONENTS AND SHARP PROTRUSIONS. EVEN THE MOTOR GETS GREASY.

MAGIC LUNG® VS OTHER BRANDS

DIFFICULT TO CLEAN

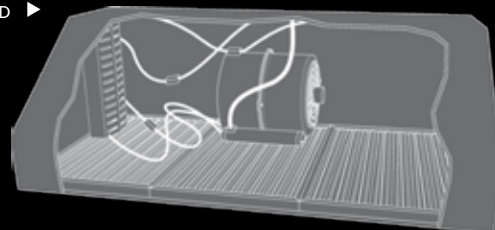

GREASE ESCAPING THE FILTERS COATS THE MOTORS AND WIRING

THE NEW IN-THE-SHIELD GREASE TRAY (OPTIONAL) MAKES ROUTINE CLEANING EASIER THAN EVER. IF DESIRED, THE MAGIC LUNG® BLOWER COMES APART FOR EASY CLEANING IN SOAPY WATER OR A DISHWASHER.

5

FLAME HAS NO ACCESS TO SECONDARY SOURCES OF COMBUSTION



NO GREASY FILTER TO SUSTAIN A SECONDARY FIRE

FIRE SAFETY

COOKING FIRES ARE THE LEADING CAUSE OF HOME FIRES (150,000 PER YEAR - NFPA) FILTERS ARE FLAMMABLE AND CAN SUSTAIN A SECONDARY FIRE NEAR THE INLET TO THE BLOWER LEADING TO A DUCT FIRE. FIRE INSURANCE CLAIMS AGAINST FILTERED HOODS ARE COMMON.

MAGIC LUNG® VS OTHER BRANDS

FLAME HAS DIRECT ACCESS TO MULTIPLE SOURCES OF COMBUSTION



GREASY FILTERS AND DUCTING ARE FLAMMABLE

THE MAGIC LUNG® CONSTANT-SPEED BLOWER IS DESIGNED TO KEEP GREASE AND FLAME FROM ENTERING THE DUCT. IN OVER 75 YEARS, VENT-A-HOOD HAS NEVER RECEIVED A REPORT OF AN ATTIC OR WALL FIRE WHEN THE MAGIC LUNG® HAS BEEN IN USE.

6

WARRANTY

THE PERFORMANCE GUARANTEED MAGIC LUNG®



MAGIC LUNG® VS OTHER BRANDS

STANDARD INDUSTRY WARRANTY



WE'VE GOT YOU COVERED WITH THE BEST WARRANTY IN THE INDUSTRY. VENT-A-HOOD® HAS LONG BEEN THE MOST RESPECTED NAME IN VENTILATION. OUR PRODUCTS ARE GUARANTEED TO WORK AND WE STAND ON OVER 75 YEARS OF MANUFACTURING THE HIGHEST QUALITY VENTILATION PRODUCTS. OUR FAMILY IS DEVOTED TO YOUR SATISFACTION.

JDIH/C1 WITH
OPTIONAL FINISH
AND TRIM



JCH/C2



DESIGNER SERIES
BEAUTY AND
PERFORMANCE

- CUSTOM DESIGNS
- OVER 200 METALLIC OR PAINTED FINISHES
- ALL MODELS INCLUDE THE MAGIC LUNG® BLOWER SYSTEM
- 50 WATT HALOGEN LIGHTS FEATURE A DUAL SWITCH FOR DIMMING TO 25 WATTS.

AVAILABLE WITH:

- 18 OR 24 GAUGE VERTICAL BANDS
- LIP TREATMENT OR HORIZONTAL BANDS
- POT RAILS OR GALLEY RAILS



JCH/C1

HOODS SHOWN WITH OPTIONAL FINISH AND TRIM. SEE YOUR LOCAL DEALER FOR DETAILS.

JCH/B1
WITH CDC DUCT COVER



JDH/C2

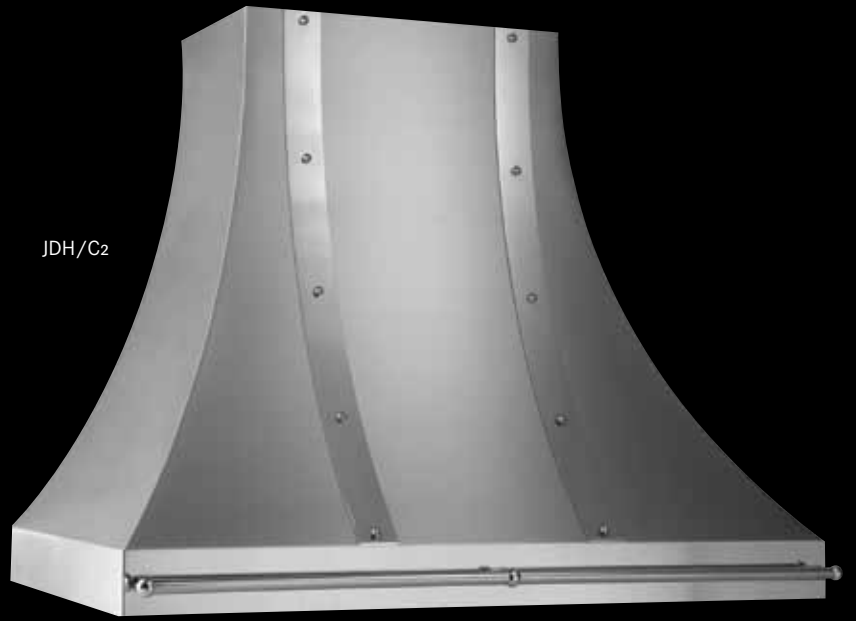

JDH/C1

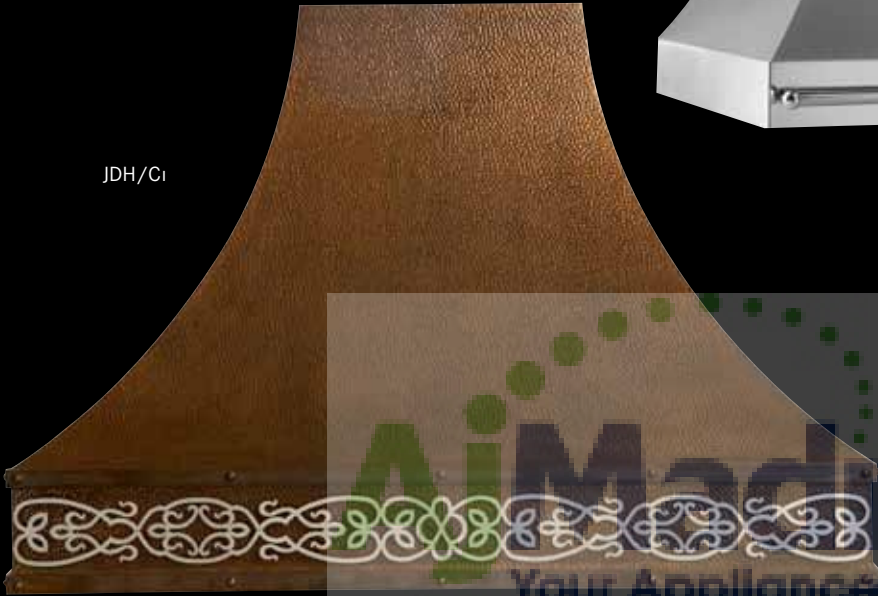

JCH/A1
WITH CDC DUCT COVER



HOODS SHOWN WITH OPTIONAL FINISH AND TRIM. SEE YOUR LOCAL DEALER FOR DETAILS.

Vent-A-Hood



UNDER CABINET PRH6-K

- COMPACT DESIGN WITH LINEAR STYLING IS THE IDEAL UPGRADE REPLACEMENT HOOD
- INCLUDES THE K SERIES BLOWER SYSTEM, WHICH IS PERFECT FOR LIGHT TO MODERATE COOKING (SOUND RATING IS 7.4 SONES AT HIGH SPEED)
- 50 WATT HALOGEN LIGHTS FEATURE A DUAL SWITCH FOR DIMMING TO 25 WATTS. NOT AVAILABLE WITH FLUORESCENT LIGHTS
- EQUIPPED WITH THE SENSASOURCE® HEAT SENSOR
- AVAILABLE IN POPULAR PAINT COLORS (BISCUIT, BLACK, GUNSMOKE AND WHITE ONLY) AND STAINLESS STEEL
- DESIGNED FOR EITHER TOP VENT OR BACK VENT INSTALLATIONS
- RECOMMENDED MOUNTING HEIGHT IS 21" - 24" ABOVE THE COOKING SURFACE

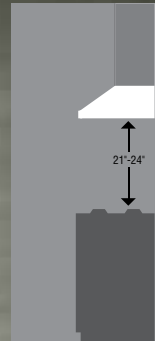

Aj Madison
Your Appliance Authority™
800-570-3355



UNDER CABINET SLH6-K

- COMPACT DESIGN WITH PATENTED EMERALD LIP IS THE IDEAL UPGRADE REPLACEMENT HOOD
- INCLUDES THE K SERIES BLOWER SYSTEM, WHICH IS PERFECT FOR LIGHT TO MODERATE COOKING (SOUND RATING IS 7.4 SONES AT HIGH SPEED)
- 50 WATT HALOGEN LIGHTS FEATURE A DUAL SWITCH FOR DIMMING TO 25 WATTS. NOT AVAILABLE WITH FLUORESCENT LIGHTS
- EQUIPPED WITH THE SENSASOURCE® HEAT SENSOR
- AVAILABLE IN POPULAR PAINT COLORS (BISCUIT, BLACK, GUNSMOKE AND WHITE ONLY) AND STAINLESS STEEL
- DESIGNED FOR EITHER TOP VENT OR BACK VENT INSTALLATIONS
- RECOMMENDED MOUNTING HEIGHT IS 21" - 24" ABOVE THE COOKING SURFACE

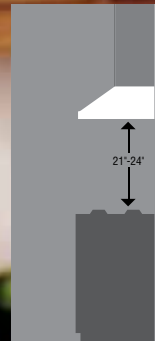



UNDER CABINET PRH9

- LINEAR STYLING PERFECTLY ACCENTS THE PROFESSIONAL-STYLED KITCHEN
- INCLUDES THE MAGIC LUNG® BLOWER SYSTEM
- 50 WATT HALOGEN LIGHTS FEATURE A DUAL SWITCH FOR DIMMING TO 25 WATTS. ALSO AVAILABLE WITH FLUORESCENT LIGHTS
- EQUIPPED WITH THE SENSASOURCE® HEAT SENSOR (HALOGEN LIGHT MODELS ONLY)
- AVAILABLE IN POPULAR STANDARD OR CUSTOM PAINT COLORS, STAINLESS STEEL, REAL BRASS, REAL COPPER OR HAMMERED COPPER
- RECOMMENDED MOUNTING HEIGHT IS 24" - 27" ABOVE THE COOKING SURFACE
- SUITABLE FOR USE IN COVERED OUTDOOR APPLICATIONS WHEN INSTALLED IN A GFCI PROTECTED BRANCH CIRCUIT
- 9" TALL, 21" BOTTOM DEPTH, 12" TOP DEPTH, 2" TALL FRONT LIP
- 300 CFM WIDTHS:
30", 36", 42" AND 48"
- 600 CFM WIDTHS:
30", 36", 42" AND 48"
- 900 CFM WIDTHS:
42" AND 48"
- 1200 CFM WIDTH:
48"

ALSO AVAILABLE
IN CUSTOM SIZES

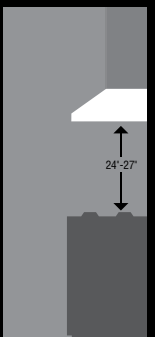



UNDER CABINET NPH9

- ROUNDED FRONT LIP PROVIDES A MODERN VISUAL IMPACT
- INCLUDES THE MAGIC LUNG® BLOWER SYSTEM
- 50 WATT HALOGEN LIGHTS FEATURE A DUAL SWITCH FOR DIMMING TO 25 WATTS. ALSO AVAILABLE WITH FLUORESCENT LIGHTS
- EQUIPPED WITH THE SENSASOURCE® HEAT SENSOR (HALOGEN LIGHT MODELS ONLY)
- AVAILABLE IN POPULAR STANDARD OR CUSTOM PAINT COLORS, STAINLESS STEEL, REAL BRASS, REAL COPPER OR HAMMERED COPPER
- RECOMMENDED MOUNTING HEIGHT IS 24" - 27" ABOVE THE COOKING SURFACE
- SUITABLE FOR USE IN COVERED OUTDOOR APPLICATIONS WHEN INSTALLED IN A GFCI PROTECTED BRANCH CIRCUIT
- 9" TALL, 21" BOTTOM DEPTH, 12" TOP DEPTH, 3" TALL FRONT LIP
- 300 CFM WIDTHS: 30", 36", 42" AND 48"
- 600 CFM WIDTHS: 30", 36", 42" AND 48"
- 900 CFM WIDTHS: 42" AND 48"
- 1200 CFM WIDTH: 48"

ALSO AVAILABLE
IN CUSTOM SIZES

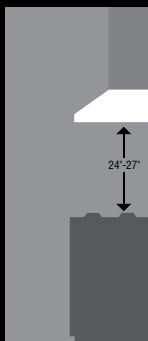

AjMadison
Your Appliance Authority
800-570-3355

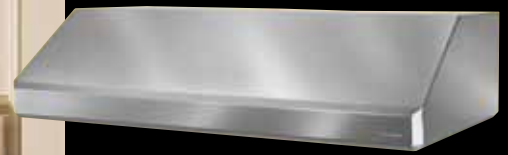

UNDER CABINET SLH9

- SOFT CUT CORNERS OF THE PATENTED EMERALD LIP YIELD A CONTEMPORARY FEEL
- INCLUDES THE MAGIC LUNG® BLOWER SYSTEM
- 50 WATT HALOGEN LIGHTS FEATURE A DUAL SWITCH FOR DIMMING TO 25 WATTS. ALSO AVAILABLE WITH FLUORESCENT LIGHTS
- EQUIPPED WITH THE SENSASOURCE® HEAT SENSOR (HALOGEN LIGHT MODELS ONLY)
- AVAILABLE IN POPULAR STANDARD OR CUSTOM PAINT COLORS, STAINLESS STEEL, REAL BRASS, REAL COPPER OR HAMMERED COPPER
- RECOMMENDED MOUNTING HEIGHT IS 24" - 27" ABOVE THE COOKING SURFACE
- SUITABLE FOR USE IN COVERED OUTDOOR APPLICATIONS WHEN INSTALLED IN A GFCI PROTECTED BRANCH CIRCUIT
- 9" TALL, 21" BOTTOM DEPTH, 12" TOP DEPTH, 2" TALL FRONT LIP
- 300 CFM WIDTHS: 30", 36", 42" AND 48"
- 600 CFM WIDTHS: 30", 36", 42" AND 48"
- 900 CFM WIDTHS: 42" AND 48"
- 1200 CFM WIDTH: 48"

ALSO AVAILABLE
IN CUSTOM SIZES

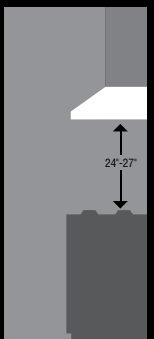

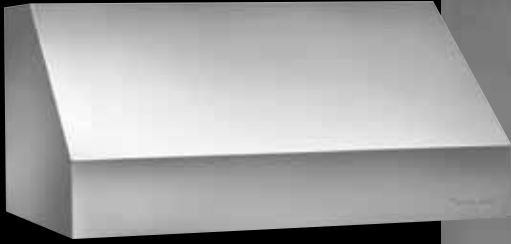

WALL MOUNT PRH 18

- LINEAR STYLING PERFECTLY ACCENTS THE PROFESSIONAL-STYLED KITCHEN
- INCLUDES THE MAGIC LUNG® BLOWER SYSTEM
- 50 WATT HALOGEN LIGHTS FEATURE A DUAL SWITCH FOR DIMMING TO 25 WATTS. ALSO AVAILABLE WITH FLUORESCENT LIGHTS
- EQUIPPED WITH THE SENSASOURCE® HEAT SENSOR (HALOGEN LIGHT MODELS ONLY)
- AVAILABLE IN POPULAR STANDARD OR CUSTOM PAINT COLORS, STAINLESS STEEL, REAL BRASS, REAL COPPER OR HAMMERED COPPER
- SHOWN WITH MATCHING WALL MOUNT DUCT COVER (SOLD SEPARATELY), AVAILABLE IN STANDARD SIZES FOR 8', 9' AND 10' CEILING HEIGHTS OR IN CUSTOM SIZES
- RECOMMENDED MOUNTING HEIGHT IS 30" ABOVE THE COOKING SURFACE
- SUITABLE FOR USE IN COVERED OUTDOOR APPLICATIONS WHEN INSTALLED IN A GFCI PROTECTED BRANCH CIRCUIT
- 18" TALL, 24" BOTTOM DEPTH, 12" TOP DEPTH, 6" TALL FRONT LIP. 27" BOTTOM DEPTH IS ALSO AVAILABLE
- 300 CFM WIDTHS: 30", 36", 42" AND 48"
- 600 CFM WIDTHS: 30", 36", 42", 48" AND 54"
- 900 CFM WIDTHS: 42", 48", 54" AND 60"
- 1200 CFM WIDTHS: 48", 54", 60" AND 66"

ALSO AVAILABLE
IN CUSTOM SIZES

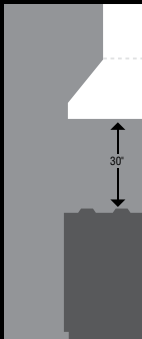

AjMadison
Your Appliance Authority™
800-570-3355

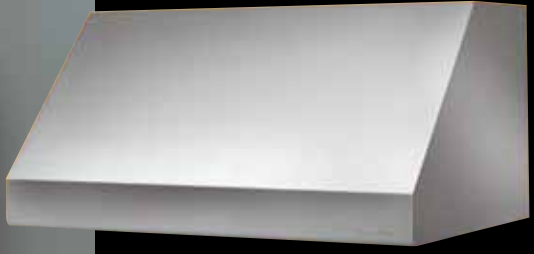

**WALL MOUNT
NPH 18**

- ROUNDED FRONT LIP PROVIDES A MODERN VISUAL IMPACT
- INCLUDES THE MAGIC LUNG® BLOWER SYSTEM
- 50 WATT HALOGEN LIGHTS FEATURE A DUAL SWITCH FOR DIMMING TO 25 WATTS. ALSO AVAILABLE WITH FLUORESCENT LIGHTS
- EQUIPPED WITH THE SENSASOURCE® HEAT SENSOR (HALOGEN LIGHT MODELS ONLY)
- AVAILABLE IN POPULAR STANDARD OR CUSTOM PAINT COLORS, STAINLESS STEEL, REAL BRASS, REAL COPPER OR HAMMERED COPPER
- INCLUDES WARMING LIGHT BAR (HEAT LAMP BULBS NOT INCLUDED). SEE PAGE 38 FOR MORE INFORMATION
- SHOWN WITH OPTIONAL WARMING SHELF ASSEMBLY (SOLD SEPARATELY). SEE PAGE 38 FOR MORE INFORMATION
- SHOWN WITH MATCHING WALL MOUNT DUCT COVER (SOLD SEPARATELY), AVAILABLE IN STANDARD SIZES FOR 8', 9' AND 10' CEILING HEIGHTS OR IN CUSTOM SIZES
- RECOMMENDED MOUNTING HEIGHT IS 30" ABOVE THE COOKING SURFACE
- SUITABLE FOR USE IN COVERED OUTDOOR APPLICATIONS WHEN INSTALLED IN A GFCI PROTECTED BRANCH CIRCUIT
- 18" TALL, 24" BOTTOM DEPTH, 12" TOP DEPTH, 4" TALL FRONT LIP. 27" BOTTOM DEPTH IS ALSO AVAILABLE
- 300 CFM WIDTHS: 30", 36", 42" AND 48"
- 600 CFM WIDTHS: 30", 36", 42", 48" AND 54"
- 900 CFM WIDTHS: 42", 48", 54" AND 60"
- 1200 CFM WIDTHS: 48", 54", 60" AND 66"

ALSO AVAILABLE IN CUSTOM SIZES

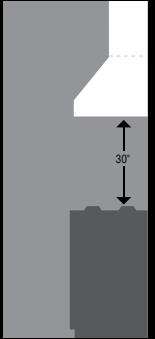



WALL MOUNT SLH 18

- SOFT CUT CORNERS OF THE PATENTED EMERALD LIP YIELD A CONTEMPORARY FEEL
- INCLUDES THE MAGIC LUNG® BLOWER SYSTEM
- 50 WATT HALOGEN LIGHTS FEATURE A DUAL SWITCH FOR DIMMING TO 25 WATTS. ALSO AVAILABLE WITH FLUORESCENT LIGHTS
- EQUIPPED WITH THE SENSASOURCE® HEAT SENSOR (HALOGEN LIGHT MODELS ONLY)
- AVAILABLE IN POPULAR STANDARD OR CUSTOM PAINT COLORS, STAINLESS STEEL, REAL BRASS, REAL COPPER OR HAMMERED COPPER
- SHOWN WITH MATCHING WALL MOUNT DUCT COVER (SOLD SEPARATELY), AVAILABLE IN STANDARD SIZES FOR 8', 9' AND 10' CEILING HEIGHTS OR IN CUSTOM SIZES
- RECOMMENDED MOUNTING HEIGHT IS 30" ABOVE THE COOKING SURFACE
- SUITABLE FOR USE IN COVERED OUTDOOR APPLICATIONS WHEN INSTALLED IN A GFCI PROTECTED BRANCH CIRCUIT
- 18" TALL, 24" BOTTOM DEPTH, 12" TOP DEPTH, 3" TALL FRONT LIP. 27" BOTTOM DEPTH IS ALSO AVAILABLE
- 300 CFM WIDTHS:
30", 36", 42" AND 48"
- 600 CFM WIDTHS:
30", 36", 42", 48"
AND 54"
- 900 CFM WIDTHS:
42", 48", 54" AND 60"
- 1200 CFM WIDTHS:
48", 54", 60" AND 66"

ALSO AVAILABLE
IN CUSTOM SIZES

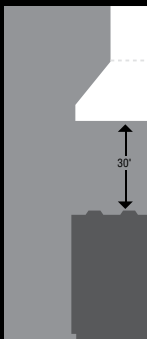

AjMadison
Your Appliance Authority™
800-570-3355



EURO STYLE WALL MOUNT PDH 1 4/PDH 1 4-K

- LINEAR STYLING PERFECTLY ACCENTS THE PROFESSIONAL-STYLED KITCHEN
- AVAILABLE WITH EITHER MAGIC LUNG® OR K SERIES BLOWER SYSTEM
- 50 WATT HALOGEN LIGHTS FEATURE A DUAL SWITCH FOR DIMMING TO 25 WATTS. ALSO AVAILABLE WITH FLUORESCENT LIGHTS (K-SERIES MODELS EXCLUDED)
- EQUIPPED WITH THE SENSASOURCE® HEAT SENSOR (HALOGEN LIGHT MODELS ONLY)
- AVAILABLE IN POPULAR STANDARD OR CUSTOM PAINT COLORS, STAINLESS STEEL, REAL BRASS, REAL COPPER OR HAMMERED COPPER
- SHOWN WITH MATCHING WALL MOUNT DUCT COVER (SOLD SEPARATELY), AVAILABLE IN STANDARD SIZES FOR 7', 8' AND 9' CEILING HEIGHTS OR IN CUSTOM SIZES
- RECOMMENDED MOUNTING HEIGHT IS 24" ABOVE THE COOKING SURFACE
- SUITABLE FOR USE IN COVERED OUTDOOR APPLICATIONS WHEN INSTALLED IN A GFCI PROTECTED BRANCH CIRCUIT
- 14" TALL, 21" BOTTOM DEPTH, 10" X 10" TOP, 2 5/8" TALL LIP
- 250 CFM WIDTHS: 30", 36", 42" AND 48"
- 300 CFM WIDTHS: 30", 36", 42" AND 48"
- 600 CFM WIDTHS: 36", 42" AND 48"

MAGIC LUNG®
MODELS ALSO
AVAILABLE IN
CUSTOM SIZES

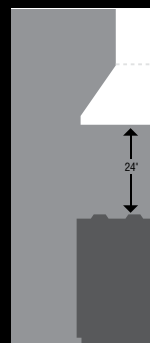



EURO STYLE WALL MOUNT SLDH 14

- SOFT CUT CORNERS OF THE PATENTED EMERALD LIP YIELD A CONTEMPORARY FEEL
- INCLUDES THE MAGIC LUNG® BLOWER SYSTEM
- 50 WATT HALOGEN LIGHTS FEATURE A DUAL SWITCH FOR DIMMING TO 25 WATTS. ALSO AVAILABLE WITH FLUORESCENT LIGHTS
- EQUIPPED WITH THE SENSASOURCE® HEAT SENSOR (HALOGEN LIGHT MODELS ONLY)
- AVAILABLE IN POPULAR STANDARD OR CUSTOM PAINT COLORS AND STAINLESS STEEL
- SHOWN WITH MATCHING WALL MOUNT DUCT COVER (SOLD SEPARATELY), AVAILABLE IN STANDARD SIZES FOR 7', 8' AND 9' CEILING HEIGHTS OR IN CUSTOM SIZES
- RECOMMENDED MOUNTING HEIGHT IS 24" ABOVE THE COOKING SURFACE
- SUITABLE FOR USE IN COVERED OUTDOOR APPLICATIONS WHEN INSTALLED IN A GFCI PROTECTED BRANCH CIRCUIT
- 14" TALL, 21" BOTTOM DEPTH, 10" X 10" TOP, 2" TALL LIP
- 300 CFM WIDTHS:
30", 36", 42" AND 48"
- 600 CFM WIDTHS:
36", 42" AND 48"

ALSO AVAILABLE
IN CUSTOM SIZES

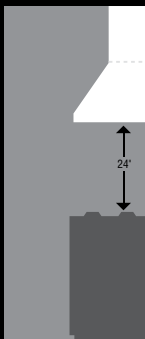

AjMadison
Your Appliance Authority™
800-570-3355



EURO STYLE WALL MOUNT EPH18/EPH18

- LINEAR STYLING PERFECTLY ACCENTS THE PROFESSIONAL STYLED KITCHEN
- INCLUDES THE MAGIC LUNG® BLOWER SYSTEM
- 50 WATT HALOGEN LIGHTS FEATURE A DUAL SWITCH FOR DIMMING TO 25 WATTS. ALSO AVAILABLE WITH FLUORESCENT LIGHTS
- EQUIPPED WITH THE SENSASOURCE® HEAT SENSOR (HALOGEN LIGHT MODELS ONLY)
- AVAILABLE IN POPULAR STANDARD OR CUSTOM PAINT COLORS, STAINLESS STEEL, REAL BRASS, REAL COPPER OR HAMMERED COPPER
- SHOWN WITH MATCHING WALL MOUNT DUCT COVER (SOLD SEPARATELY), AVAILABLE IN STANDARD SIZES FOR 8', 9' AND 10' CEILING HEIGHTS OR IN CUSTOM SIZES
- RECOMMENDED MOUNTING HEIGHT IS 30" ABOVE THE COOKING SURFACE
- SUITABLE FOR USE IN COVERED OUTDOOR APPLICATIONS WHEN INSTALLED IN A GFCI PROTECTED BRANCH CIRCUIT
- 18" TALL, 24" BOTTOM DEPTH, 4" TALL LIP. 27" BOTTOM DEPTH IS ALSO AVAILABLE
- EPH18
600 CFM WIDTHS:
36", 42" AND 48"
TOP DIMENSIONS
12" WIDE X 12" DEEP
- EPTH18
900 CFM WIDTHS:
42", 48", 54", 60"
AND 66"
1200 CFM WIDTHS:
54", 60" AND 66"
TOP DIMENSIONS
26" WIDE X 14" DEEP

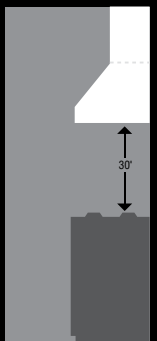

EPTH18



**EURO STYLE
WALL MOUNT
NEPH18/NEPTH18**

- ROUNDED FRONT LIP PROVIDES A MODERN VISUAL IMPACT
- INCLUDES THE MAGIC LUNG® BLOWER SYSTEM
- 50 WATT HALOGEN LIGHTS FEATURE A DUAL SWITCH FOR DIMMING TO 25 WATTS. ALSO AVAILABLE WITH FLUORESCENT LIGHTS
- EQUIPPED WITH THE SENSASOURCE® HEAT SENSOR (HALOGEN LIGHT MODELS ONLY)
- AVAILABLE IN POPULAR STANDARD OR CUSTOM PAINT COLORS, STAINLESS STEEL, REAL BRASS, REAL COPPER OR HAMMERED COPPER
- SHOWN WITH MATCHING WALL MOUNT DUCT COVER (SOLD SEPARATELY), AVAILABLE IN STANDARD SIZES FOR 8', 9' AND 10' CEILING HEIGHTS OR IN CUSTOM SIZES
- RECOMMENDED MOUNTING HEIGHT IS 30" ABOVE THE COOKING SURFACE
- SUITABLE FOR USE IN COVERED OUTDOOR APPLICATIONS WHEN INSTALLED IN A GFCI PROTECTED BRANCH CIRCUIT
- 18" TALL, 24" BOTTOM DEPTH, 4" TALL LIP. 27" BOTTOM DEPTH IS ALSO AVAILABLE

• NEPH18
600 CFM WIDTHS:
36", 42" AND 48"

TOP DIMENSIONS
12" WIDE X 12" DEEP

• NEPTH18
900 CFM WIDTHS:
42", 48", 54", 60"
AND 66"

1200 CFM WIDTHS:
54", 60" AND 66"

TOP DIMENSIONS
26" WIDE X 14" DEEP

ALSO AVAILABLE
IN CUSTOM SIZES

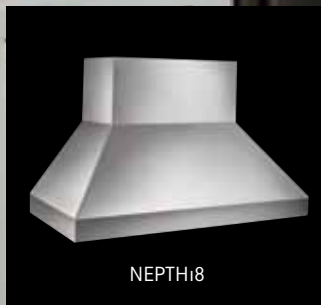
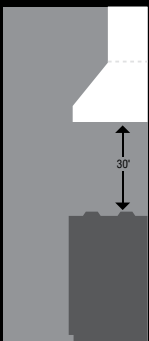

NEPTH18

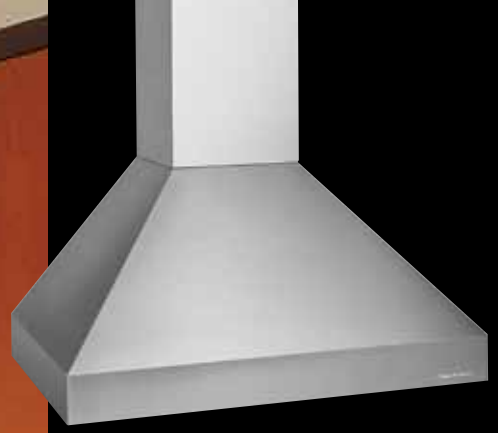

**EURO STYLE
WALL MOUNT
SEPH18/SEPH18**

- SOFT CUT CORNERS OF THE PATENTED EMERALD LIP YIELD A CONTEMPORARY FEEL
- INCLUDES THE MAGIC LUNG® BLOWER SYSTEM
- 50 WATT HALOGEN LIGHTS FEATURE A DUAL SWITCH FOR DIMMING TO 25 WATTS. ALSO AVAILABLE WITH FLUORESCENT LIGHTS
- EQUIPPED WITH THE SENSASOURCE® HEAT SENSOR (HALOGEN LIGHT MODELS ONLY)
- AVAILABLE IN POPULAR STANDARD OR CUSTOM PAINT COLORS AND STAINLESS STEEL
- SHOWN WITH MATCHING WALL MOUNT DUCT COVER (SOLD SEPARATELY), AVAILABLE IN STANDARD SIZES FOR 8', 9' AND 10' CEILING HEIGHTS OR IN CUSTOM SIZES
- RECOMMENDED MOUNTING HEIGHT IS 30" ABOVE THE COOKING SURFACE
- SUITABLE FOR USE IN COVERED OUTDOOR APPLICATIONS WHEN INSTALLED IN A GFCI PROTECTED BRANCH CIRCUIT
- 18" TALL, 24" BOTTOM DEPTH, 3" TALL LIP. 27" BOTTOM DEPTH IS ALSO AVAILABLE

• SEPH18
600 CFM WIDTHS:
36", 42" AND 48"

TOP DIMENSIONS
12" WIDE X 12" DEEP

• SEPH18
900 CFM WIDTHS:
42", 48", 54", 60"
AND 66"

1200 CFM WIDTHS:
54", 60" AND 66"

TOP DIMENSIONS
26" WIDE X 14" DEEP

ALSO AVAILABLE
IN CUSTOM SIZES



SEPH18

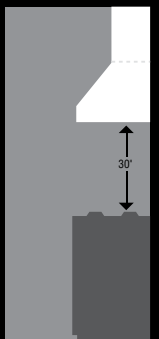

Designer: Rivers Kitchens Inc.
Photographer: Peter Rymwid



CONTEMPORARY WALL MOUNT GTH-K

- COMPACT GLASS FRONT DESIGN WITH A CONTEMPORARY FEEL
- INCLUDES THE THE K SERIES BLOWER SYSTEM, WHICH IS PERFECT FOR LIGHT TO MODERATE COOKING (SOUND RATING IS 7.4 SONES AT HIGH SPEED)
- 50 WATT HALOGEN LIGHTS FEATURE A DUAL SWITCH FOR DIMMING TO 25 WATTS
- EQUIPPED WITH THE SENSASOURCE® HEAT SENSOR
- AVAILABLE IN STAINLESS STEEL
- INCLUDES FIXED LENGTH STAINLESS STEEL RAILS
- SHOWN WITH MATCHING WALL MOUNT DUCT COVER (SOLD SEPARATELY), AVAILABLE IN STANDARD SIZES FOR 7', 8' AND 9' CEILING HEIGHTS OR IN CUSTOM SIZES. DUCT COVER IS 12" X 12" WITH A ROUNDED FRONT
- RECOMMENDED MOUNTING HEIGHT IS 24" ABOVE THE COOKING SURFACE
- SUITABLE FOR USE IN COVERED OUTDOOR APPLICATIONS WHEN INSTALLED IN A GFCI PROTECTED BRANCH CIRCUIT
- 8" TALL, 21" BOTTOM DEPTH, 1 3/4" TALL LIP ON SIDES
- 250 CFM WIDTH:
36"

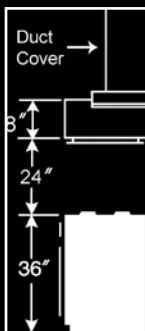

At Madison
Your Appliance Authority™
800-570-3355





CONTEMPORARY WALL MOUNT ZTH

- GLASS FRONT DESIGN WITH A CONTEMPORARY FEEL FOR USE OVER MOST PROFESSIONAL STYLE RANGES
- INCLUDES THE MAGIC LUNG® BLOWER SYSTEM
- 50 WATT HALOGEN LIGHTS FEATURE A DUAL SWITCH FOR DIMMING TO 25 WATTS
- EQUIPPED WITH THE SENSASOURCE® HEAT SENSOR
- AVAILABLE IN STAINLESS STEEL
- INCLUDES FIXED LENGTH STAINLESS STEEL RAILS
- SHOWN WITH MATCHING WALL MOUNT DUCT COVER (SOLD SEPARATELY) AVAILABLE IN STANDARD SIZES FOR 7', 8' AND 9' CEILING HEIGHTS OR IN CUSTOM SIZES
- RECOMMENDED MOUNTING HEIGHT IS 30" ABOVE THE COOKING SURFACE
- SUITABLE FOR USE IN COVERED OUTDOOR APPLICATIONS WHEN INSTALLED IN A GFCI PROTECTED BRANCH CIRCUIT
- 12" TALL, 24" BOTTOM DEPTH, 1" TALL LIP ON SIDES
- 600 CFM WIDTHS:
36", 42" AND 48"
DUCT COVER IS 12" WIDE X 12" DEEP WITH A ROUNDED FRONT
- 900 CFM WIDTH:
54"
DUCT COVER IS 28" WIDE X 12" DEEP WITH A ROUNDED FRONT

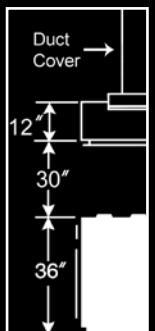

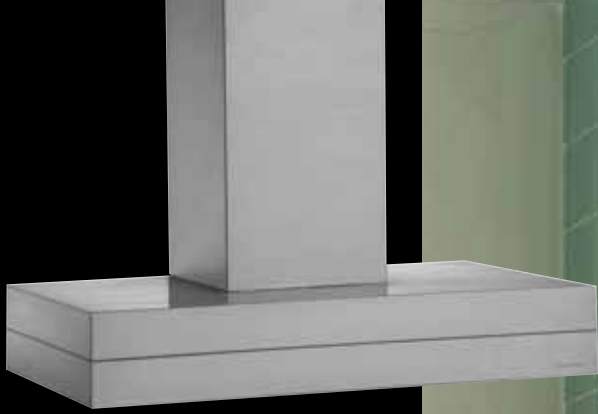

CONTEMPORARY WALL MOUNT CWEH6-K

- COMPACT SPLIT-LAYERED VISUAL EFFECT IS THE IDEAL ADDITION TO ANY CONTEMPORARY KITCHEN
- INCLUDES THE K SERIES BLOWER SYSTEM, WHICH IS PERFECT FOR LIGHT TO MODERATE COOKING (SOUND RATING IS 7.4 SONES AT HIGH SPEED)
- 50 WATT HALOGEN LIGHTS FEATURE A DUAL SWITCH FOR DIMMING TO 25 WATTS
- EQUIPPED WITH THE SENSASOURCE® HEAT SENSOR
- AVAILABLE IN POPULAR PAINT COLORS (BISCUIT, BLACK, GUNSMOKE AND WHITE ONLY) AND STAINLESS STEEL
- SHOWN WITH MATCHING WALL MOUNT DUCT COVER (SOLD SEPARATELY), AVAILABLE IN STANDARD SIZES FOR 7', 8' AND 9' CEILING HEIGHTS OR IN CUSTOM SIZES
- RECOMMENDED MOUNTING HEIGHT IS 24" ABOVE THE COOKING SURFACE
- SUITABLE FOR USE IN COVERED OUTDOOR APPLICATIONS WHEN INSTALLED IN A GFCI PROTECTED BRANCH CIRCUIT
- 6" TALL, 21" BOTTOM DEPTH
- 250 CFM WIDTHS:
30", 36", 42" AND 48"

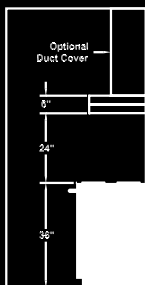

AjMadison
Your Appliance Authority™
800-570-3355



CONTEMPORARY WALL MOUNT CWEH9

- SPLIT-LAYERED VISUAL EFFECT IS THE IDEAL ADDITION TO ANY CONTEMPORARY KITCHEN
- INCLUDES THE MAGIC LUNG® BLOWER SYSTEM
- 50 WATT HALOGEN LIGHTS FEATURE A DUAL SWITCH FOR DIMMING TO 25 WATTS
- EQUIPPED WITH SENSASOURCE® HEAT SENSOR
- AVAILABLE IN POPULAR STANDARD OR CUSTOM PAINT COLORS AND STAINLESS STEEL
- SHOWN WITH MATCHING WALL MOUNT DUCT COVERS (SOLD SEPARATELY), AVAILABLE IN STANDARD SIZES FOR 7', 8' AND 9' CEILING HEIGHTS OR IN CUSTOM SIZES
- RECOMMENDED MOUNTING HEIGHT IS 27" ABOVE THE COOKING SURFACE
- SUITABLE FOR USE IN COVERED OUTDOOR APPLICATIONS WHEN INSTALLED IN A GFCI PROTECTED BRANCH CIRCUIT
- 9" TALL, 21" BOTTOM DEPTH
- 300 CFM WIDTHS:
30", 36", 42" AND 48"
SINGLE DUCT COVER
- 600 CFM WIDTHS:
30", 36", 42", 48" AND 54"
SINGLE DUCT COVER
- 900 CFM WIDTHS:
42", 48", 54"
AND 60"
DUAL DUCT COVERS
- 1200 CFM WIDTHS:
48", 54", 60"
AND 66"
DUAL DUCT COVERS

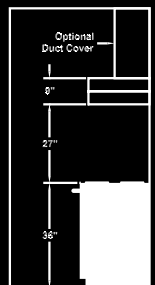



CONTEMPORARY WALL MOUNT CWLH9

- MULTI-LAYERED VISUAL EFFECT IS THE IDEAL ADDITION TO ANY CONTEMPORARY KITCHEN
- INCLUDES THE MAGIC LUNG® BLOWER SYSTEM
- 50 WATT HALOGEN LIGHTS FEATURE A DUAL SWITCH FOR DIMMING TO 25 WATTS
- EQUIPPED WITH THE SENSASOURCE® HEAT SENSOR
- AVAILABLE IN POPULAR STANDARD OR CUSTOM PAINT COLORS AND STAINLESS STEEL
- INCLUDES STAINLESS STEEL GALLEY RAIL
- SHOWN WITH MATCHING WALL MOUNT DUCT COVER (SOLD SEPARATELY), AVAILABLE IN STANDARD SIZES FOR 7', 8', AND 9' CEILING HEIGHTS OR IN CUSTOM SIZES
- RECOMMENDED MOUNTING HEIGHT IS 27" ABOVE THE COOKING SURFACE
- SUITABLE FOR USE IN COVERED OUTDOOR APPLICATIONS WHEN INSTALLED IN A GFCI PROTECTED BRANCH CIRCUIT
- 9" TALL, 21" BOTTOM DEPTH, 4 1/2" TALL LIP
- 300 CFM WIDTHS:
30", 36", 42" AND 48"
DUCT COVER IS 12" WIDE X 12" DEEP
- 600 CFM WIDTHS:
36", 42" AND 48"
DUCT COVER IS 12" WIDE X 12" DEEP
- 900 CFM WIDTHS:
54" AND 60"
DUCT COVER IS 26" WIDE X 12" DEEP
- 1200 CFM WIDTHS:
60" AND 66"
DUCT COVER IS 34" WIDE X 12" DEEP

ALSO AVAILABLE
IN CUSTOM SIZES

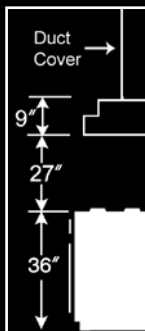



 Your Appliance Authority™
 800-570-3355



CONTEMPORARY WALL MOUNT XLH 12

- UNIQUE ROUNDED SHAPE CREATES A "ONE-OF-A-KIND" STATEMENT
- INCLUDES THE MAGIC LUNG® BLOWER SYSTEM
- 50 WATT HALOGEN LIGHTS FEATURE A DUAL SWITCH FOR DIMMING TO 25 WATTS
- EQUIPPED WITH THE SENSASOURCE® HEAT SENSOR
- AVAILABLE IN STAINLESS STEEL
- INCLUDES BRASS, COPPER, STAINLESS STEEL OR MIRROR STAINLESS STEEL LIP TREATMENT
- SHOWN ABOVE AND AT RIGHT WITH MATCHING 8" FINISHED ROUND DUCT (SOLD SEPARATELY) AND ROUND DUCT COLLARS (SOLD SEPARATELY, SQUARE DUCT COLLARS ALSO AVAILABLE). SHOWN BELOW LEFT WITH MATCHING 10" X 10" WALL MOUNT DUCT COVER (SOLD SEPARATELY), AVAILABLE IN STANDARD SIZES FOR 7', 8' AND 9' CEILING HEIGHTS OR IN CUSTOM SIZES
- RECOMMENDED MOUNTING HEIGHT IS 24" ABOVE THE COOKING SURFACE
- SUITABLE FOR USE IN COVERED OUTDOOR APPLICATIONS WHEN INSTALLED IN A GFCI PROTECTED BRANCH CIRCUIT
- 12" TALL, 21" BOTTOM DEPTH, 2" TALL LIP
- 600 CFM WIDTHS: 30" AND 36"



XLH12 WITH OPTIONAL 10" X 10" DUCT COVER

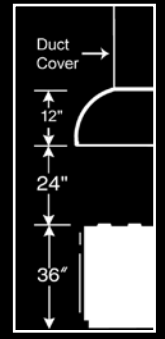

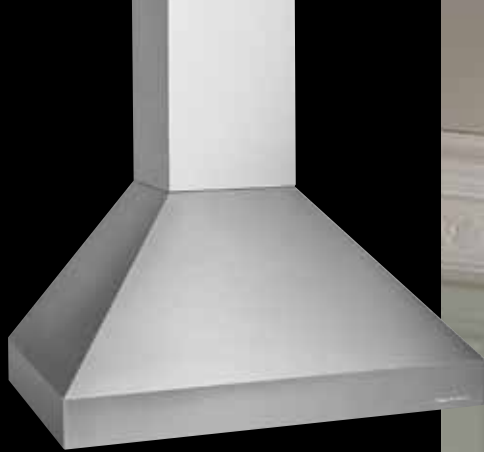

**EURO STYLE
ISLAND
PYDH 18/EPIH 18
EPITH 18**

- LINEAR STYLING PERFECTLY ACCENTS THE PROFESSIONAL-STYLED KITCHEN
- INCLUDES THE MAGIC LUNG® BLOWER SYSTEM
- 50 WATT HALOGEN LIGHTS FEATURE A DUAL SWITCH FOR DIMMING TO 25 WATTS. ALSO AVAILABLE WITH FLUORESCENT LIGHTS
- EQUIPPED WITH THE SENSASOURCE® HEAT SENSOR (HALOGEN LIGHT MODELS ONLY)
- AVAILABLE IN POPULAR STANDARD OR CUSTOM PAINT COLORS, STAINLESS STEEL, REAL BRASS, REAL COPPER OR HAMMERED COPPER
- SHOWN WITH MATCHING ISLAND DUCT COVER (SOLD SEPARATELY), AVAILABLE IN STANDARD SIZES FOR 8', 9' AND 10' CEILING HEIGHTS OR IN CUSTOM SIZES
- RECOMMENDED MOUNTING HEIGHT IS 30" ABOVE THE COOKING SURFACE
- SUITABLE FOR USE IN COVERED OUTDOOR APPLICATIONS WHEN INSTALLED IN A GFCI PROTECTED BRANCH CIRCUIT
- 18" TALL, 4" TALL LIP
- PYDH18
550 CFM WIDTHS:
36", 42" AND 48"
TOP DIMENSIONS
12" WIDE X 12" DEEP
BOTTOM DEPTH - 27"
- EPIH18
550 CFM WIDTHS:
36", 42" AND 48"
TOP DIMENSIONS
12" WIDE X 12" DEEP
BOTTOM DEPTH - 30"
- EPITH18
1100 CFM WIDTHS:
48", 54", 60" AND 66"
TOP DIMENSIONS
15" WIDE X 15" DEEP
BOTTOM DEPTH - 30"

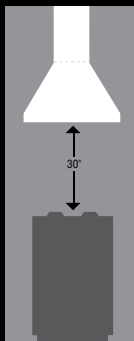

ALSO AVAILABLE
IN CUSTOM SIZES





**EURO STYLE
ISLAND
ISDH 18/SEPIH 18
SEPITH 18**

- SOFT CUT CORNERS OF THE PATENTED EMERALD LIP YIELD A CONTEMPORARY FEEL
- INCLUDES THE MAGIC LUNG® BLOWER SYSTEM
- 50 WATT HALOGEN LIGHTS FEATURE A DUAL SWITCH FOR DIMMING TO 25 WATTS
- EQUIPPED WITH THE SENSASOURCE® HEAT SENSOR (HALOGEN LIGHT MODELS ONLY)
- AVAILABLE IN POPULAR STANDARD OR CUSTOM PAINT COLORS AND STAINLESS STEEL. NOT AVAILABLE IN REAL BRASS, REAL COPPER OR HAMMERED COPPER
- SHOWN WITH MATCHING ISLAND DUCT COVER (SOLD SEPARATELY), AVAILABLE IN STANDARD SIZES FOR 8', 9' AND 10' CEILING HEIGHTS OR IN CUSTOM SIZES
- RECOMMENDED MOUNTING HEIGHT IS 30" ABOVE THE COOKING SURFACE
- SUITABLE FOR USE IN COVERED OUTDOOR APPLICATIONS WHEN INSTALLED IN A GFCI PROTECTED BRANCH CIRCUIT
- 18" TALL, 3" TALL LIP

• ISDH18
550 CFM WIDTHS:
36", 42" AND 48"
TOP DIMENSIONS
12" WIDE X 12" DEEP
BOTTOM DEPTH - 27"

• SEPIH18
550 CFM WIDTHS:
36", 42" AND 48"
TOP DIMENSIONS
12" WIDE X 12" DEEP
BOTTOM DEPTH - 30"

• SEPITH18
1100 CFM WIDTHS:
48", 54", 60" AND 66"
TOP DIMENSIONS
15" WIDE X 15" DEEP
BOTTOM DEPTH - 30"

ALSO AVAILABLE
IN CUSTOM SIZES

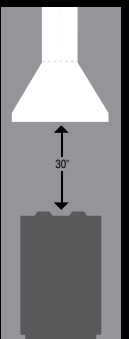

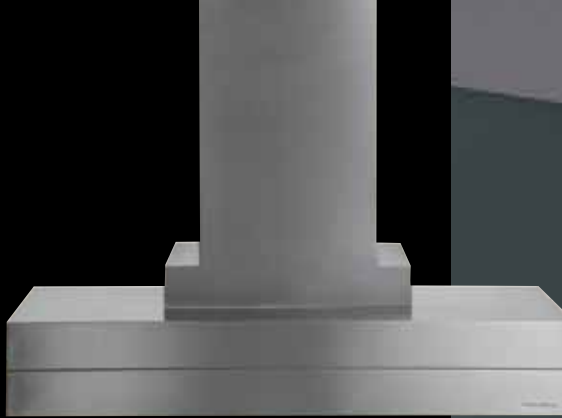

CONTEMPORARY ISLAND CIEH9

- SPLIT-LAYERED VISUAL EFFECT IS THE IDEAL ADDITION TO ANY CONTEMPORARY KITCHEN
- INCLUDES THE MAGIC LUNG® BLOWER SYSTEM
- 50 WATT HALOGEN LIGHTS FEATURE A DUAL SWITCH FOR DIMMING TO 25 WATTS
- EQUIPPED WITH SENSASOURCE® HEAT SENSOR
- AVAILABLE IN POPULAR STANDARD OR CUSTOM PAINT COLORS AND STAINLESS STEEL
- SHOWN WITH MATCHING ISLAND DUCT COVER (SOLD SEPARATELY), AVAILABLE IN STANDARD SIZES FOR 7', 8' AND 9' CEILING HEIGHTS OR IN CUSTOM SIZES. DUCT COVERS ARE 20" WIDE X 14" DEEP AT THE BOTTOM, 14" WIDE X 14" DEEP AT THE TOP
- RECOMMENDED MOUNTING HEIGHT IS 30" ABOVE THE COOKING SURFACE
- SUITABLE FOR USE IN COVERED OUTDOOR APPLICATIONS WHEN INSTALLED IN A GFCI PROTECTED BRANCH CIRCUIT
- 9" TALL, 27" BOTTOM DEPTH
- 550 CFM WIDTHS:
36", 42", 48" AND 54"
SINGLE DUCT COVER
- 1100 CFM WIDTHS:
60" AND 66"
DUAL DUCT COVERS

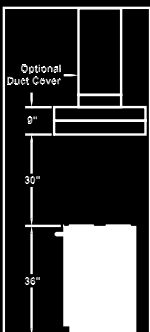

AjMadison
Your Appliance Authority™
800-570-3355





CONTEMPORARY ISLAND CILH9

- MULTI-LAYERED VISUAL EFFECT IS THE IDEAL ADDITION TO ANY CONTEMPORARY KITCHEN
- INCLUDES THE MAGIC LUNG® BLOWER SYSTEM
- 50 WATT HALOGEN LIGHTS FEATURE A DUAL SWITCH FOR DIMMING TO 25 WATTS
- EQUIPPED WITH THE SENSASOURCE® HEAT SENSOR
- AVAILABLE IN POPULAR STANDARD OR CUSTOM PAINT COLORS AND STAINLESS STEEL
- INCLUDES STAINLESS STEEL GALLEY RAIL
- SHOWN WITH MATCHING ISLAND DUCT COVER (SOLD SEPARATELY), AVAILABLE IN STANDARD SIZES FOR 7', 8' AND 9' CEILING HEIGHTS OR IN CUSTOM SIZES. DUCT COVERS ARE 20" WIDE X 14" DEEP AT THE BOTTOM, 14" WIDE X 14" DEEP AT THE TOP
- RECOMMENDED MOUNTING HEIGHT IS 30" ABOVE THE COOKING SURFACE
- SUITABLE FOR USE IN COVERED OUTDOOR APPLICATIONS WHEN INSTALLED IN A GFCI PROTECTED BRANCH CIRCUIT
- 9" TALL, 30" BOTTOM DEPTH, 4 1/2" TALL LIP
- 550 CFM WIDTHS: 42", 48" AND 54" SINGLE DUCT COVER
- 1100 CFM WIDTHS: 60" AND 66" DUAL DUCT COVERS

ALSO AVAILABLE
IN CUSTOM SIZES

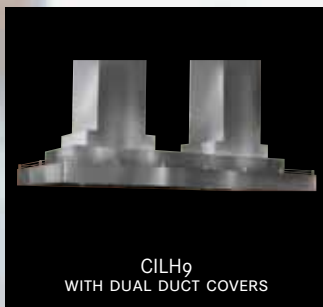
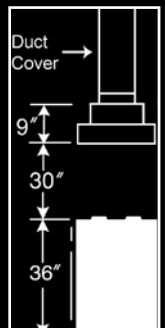

CILH9
WITH DUAL DUCT COVERS

CONTEMPORARY ISLAND IZTH

- GLASS FRONT DESIGN WITH A CONTEMPORARY FEEL FOR USE OVER MOST PROFESSIONAL STYLE RANGES
- INCLUDES THE MAGIC LUNG® BLOWER SYSTEM
- 50 WATT HALOGEN LIGHTS FEATURE A DUAL SWITCH FOR DIMMING TO 25 WATTS
- EQUIPPED WITH THE SENSASOURCE® HEAT SENSOR
- AVAILABLE IN STAINLESS STEEL
- INCLUDES FIXED LENGTH STAINLESS STEEL RAILS
- SHOWN WITH MATCHING ISLAND DUCT COVER (SOLD SEPARATELY), AVAILABLE IN STANDARD SIZES FOR 7', 8' AND 9' CEILING HEIGHTS OR IN CUSTOM SIZES
- RECOMMENDED MOUNTING HEIGHT IS 30" ABOVE THE COOKING SURFACE
- SUITABLE FOR USE IN COVERED OUTDOOR APPLICATIONS WHEN INSTALLED IN A GFCI PROTECTED BRANCH CIRCUIT
- 14" TALL, 30" BOTTOM DEPTH, 1" TALL LIP ON SIDES
- 550 CFM WIDTHS:
42" AND 48"
DUCT COVER IS
18" WIDE X 15" DEEP
- 1100 CFM WIDTHS:
54", 60" AND 66"
DUCT COVER IS
22" WIDE X 15" DEEP

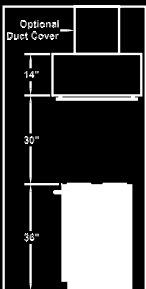

AjMadison
Your Appliance Authority™
800-570-3355



WALL MOUNT LINER INSERT KHSLD

- LINER INSERT WITH A COMPACT DESIGN FOR USE IN NARROW DEPTH INSTALLATIONS
- INCLUDES THE K SERIES BLOWER SYSTEM, WHICH IS PERFECT FOR LIGHT TO MODERATE COOKING (SOUND RATING IS 7.4 SONES AT HIGH SPEED)
- 50 WATT HALOGEN LIGHTS FEATURE A DUAL SWITCH FOR DIMMING TO 25 WATTS
- EQUIPPED WITH THE SENSASOURCE® HEAT SENSOR
- AVAILABLE IN POPULAR PAINT COLORS (BISCUIT, BLACK, GUNSMOKE AND WHITE ONLY) AND STAINLESS STEEL
- DESIGNED FOR EITHER TOP VENT OR BACK VENT INSTALLATIONS
- RECOMMENDED MOUNTING HEIGHT IS 21" - 24" ABOVE THE COOKING SURFACE
- SUITABLE FOR USE IN COVERED OUTDOOR APPLICATIONS WHEN INSTALLED IN A GFCI PROTECTED BRANCH CIRCUIT
- 6" TALL, 18" BOTTOM DEPTH, 16 1/2" TOP DEPTH, 2 1/2" TALL LIP
- 250 CFM WIDTHS:
28 3/8", 34 3/8" AND 40 3/8"
TOP WIDTH 5" LESS THAN BOTTOM WIDTH

AjMadison
Your Appliance Authority™
800-570-3355

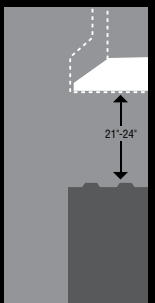

**WALL MOUNT
LINER INSERT
BHSLD/BHPSLD
BHPSLB**

- LINER INSERTS DESIGNED TO FIT MOST ANY APPLICATION
- INCLUDES THE MAGIC LUNG® BLOWER SYSTEM
- 50 WATT HALOGEN LIGHTS FEATURE A DUAL SWITCH FOR DIMMING TO 25 WATTS. ALSO AVAILABLE WITH FLUORESCENT LIGHTS
- EQUIPPED WITH THE SENSASOURCE® HEAT SENSOR (HALOGEN LIGHT MODELS ONLY)
- AVAILABLE IN POPULAR STANDARD OR CUSTOM PAINT COLORS AND STAINLESS STEEL
- RECOMMENDED MOUNTING HEIGHT IS 24" - 27" (BHSLD) OR 27" - 30" (BHPSLB AND BHPSLD) ABOVE THE COOKING SURFACE
- SUITABLE FOR USE IN COVERED OUTDOOR APPLICATIONS WHEN INSTALLED IN A GFCI PROTECTED BRANCH CIRCUIT
- 12" TALL, 12" TOP DEPTH, 3" TALL LIP
- BHSLD
300 CFM WIDTHS:
28 3/8", 34 3/8" AND 40 3/8"
600 CFM WIDTHS:
28 3/8", 34 3/8", 40 3/8" AND 46 3/8"
900 CFM WIDTH 46 3/8"
TOP WIDTH 6" LESS THAN BOTTOM WIDTH
19 1/4" BOTTOM DEPTH
- BHPSLD
600 CFM WIDTHS:
28 3/8", 34 3/8", 40 3/8", 46 3/8" AND 52 3/8"
900 CFM WIDTHS:
46 3/8", 52 3/8" AND 58 3/8"
1200 CFM WIDTHS:
52 3/8", 58 3/8" AND 64 3/8"
TOP WIDTH 6" LESS THAN BOTTOM WIDTH
22 1/2" BOTTOM DEPTH

- BHPSLB
900 CFM WIDTH*:
40 3/8"

1200 CFM WIDTH:
46 3/8"

22 1/2" BOTTOM DEPTH

TOP WIDTH IS THE SAME AS BOTTOM WIDTH

CUSTOM LINER INSERTS ALSO AVAILABLE

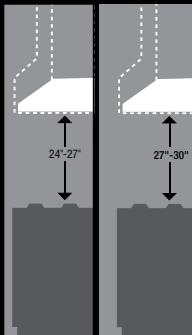

*HALOGEN ONLY

BHSLD

BHPSLD
BHPSLB



ISLAND LINER INSERT THSLE/THPSLE

- LINER INSERTS DESIGNED TO FIT MOST ANY APPLICATION
 - INCLUDES THE MAGIC LUNG® BLOWER SYSTEM
 - 50 WATT HALOGEN LIGHTS FEATURE A DUAL SWITCH FOR DIMMING TO 25 WATTS. ALSO AVAILABLE WITH FLUORESCENT LIGHTS
 - EQUIPPED WITH THE SENSASOURCE® HEAT SENSOR (HALOGEN LIGHT MODELS ONLY)
 - AVAILABLE IN POPULAR STANDARD OR CUSTOM PAINT COLORS AND STAINLESS STEEL
 - RECOMMENDED MOUNTING HEIGHT IS 30" ABOVE THE COOKING SURFACE
 - SUITABLE FOR USE IN COVERED OUTDOOR APPLICATIONS WHEN INSTALLED IN A GFCI PROTECTED BRANCH CIRCUIT
 - 12" TALL, 3" TALL LIP
 - THSLE
550 CFM WIDTHS:
36", 42" AND 48"
TOP WIDTH 12" LESS THAN BOTTOM WIDTH
15" TOP DEPTH
27" BOTTOM DEPTH
 - THPSLE
1100 CFM WIDTHS:
48", 54", 60" AND 66"
TOP WIDTH 16" LESS THAN BOTTOM WIDTH
22" TOP DEPTH
30" BOTTOM DEPTH
- CUSTOM LINER INSERTS ALSO AVAILABLE

AjMadison
Your Appliance Authority™
800-570-3355

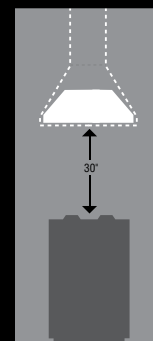

IF YOU CAN DREAM IT, WE WILL MAKE IT
CREATE YOUR OWN CUSTOM HOOD IN 3 EASY STEPS



- STEP 1 DETERMINE WHAT WIDTH, CFM AND LIGHTING IS REQUIRED FOR YOUR APPLICATION. A HOOD SELECTION CHECKLIST CAN BE FOUND ON PAGES 42-43 OF THIS CATALOG.
- STEP 2 SKETCH THE HOOD OF YOUR DREAMS. MAKE SURE TO INCLUDE AS MANY DIMENSIONS AS YOU CAN; THEY'RE IMPORTANT.
- STEP 3 ADD COLOR, TRIM, POT RAILS OR OTHER DECORATIVE FEATURES TO TRULY MAKE IT YOUR OWN. DECORATIVE OPTIONS CAN BE FOUND ON PAGES 38-39.

**CUSTOM
HOODS**



Wilson
Your Appliance Authority™
800-570-6355

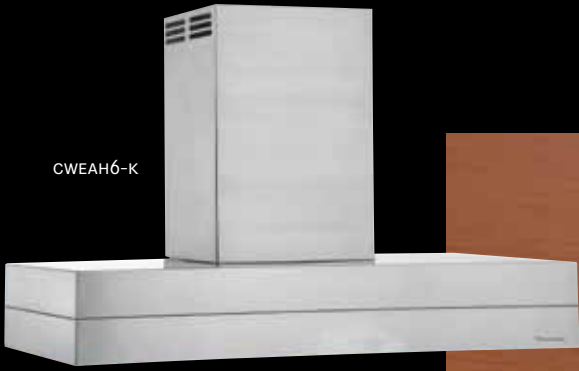

CWEAH6-K



PDAH14-K

AIR RECOVERY SYSTEM ARS

- OUR REVOLUTIONARY ARS TECHNOLOGY IS IDEAL FOR APPLICATIONS WHERE DUCTING IS NOT AN OPTION
- INCLUDES THE DUCT-FREE K SERIES BLOWER SYSTEM
- 50 WATT HALOGEN LIGHTS FEATURE A DUAL SWITCH FOR DIMMING TO 25 WATTS
- AVAILABLE IN POPULAR STANDARD OR CUSTOM PAINT COLORS AND STAINLESS STEEL (PDAH14-K IS ALSO AVAILABLE IN OVERLAY FINISHES)
- RECOMMENDED MOUNTING HEIGHT IS 24" ABOVE THE COOKING SURFACE

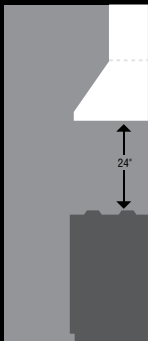

Aj Madison
Appliance Authority™
800-570-3355

THE VENT-A-HOOD® 4 PHASE AIR RECOVERY SYSTEM

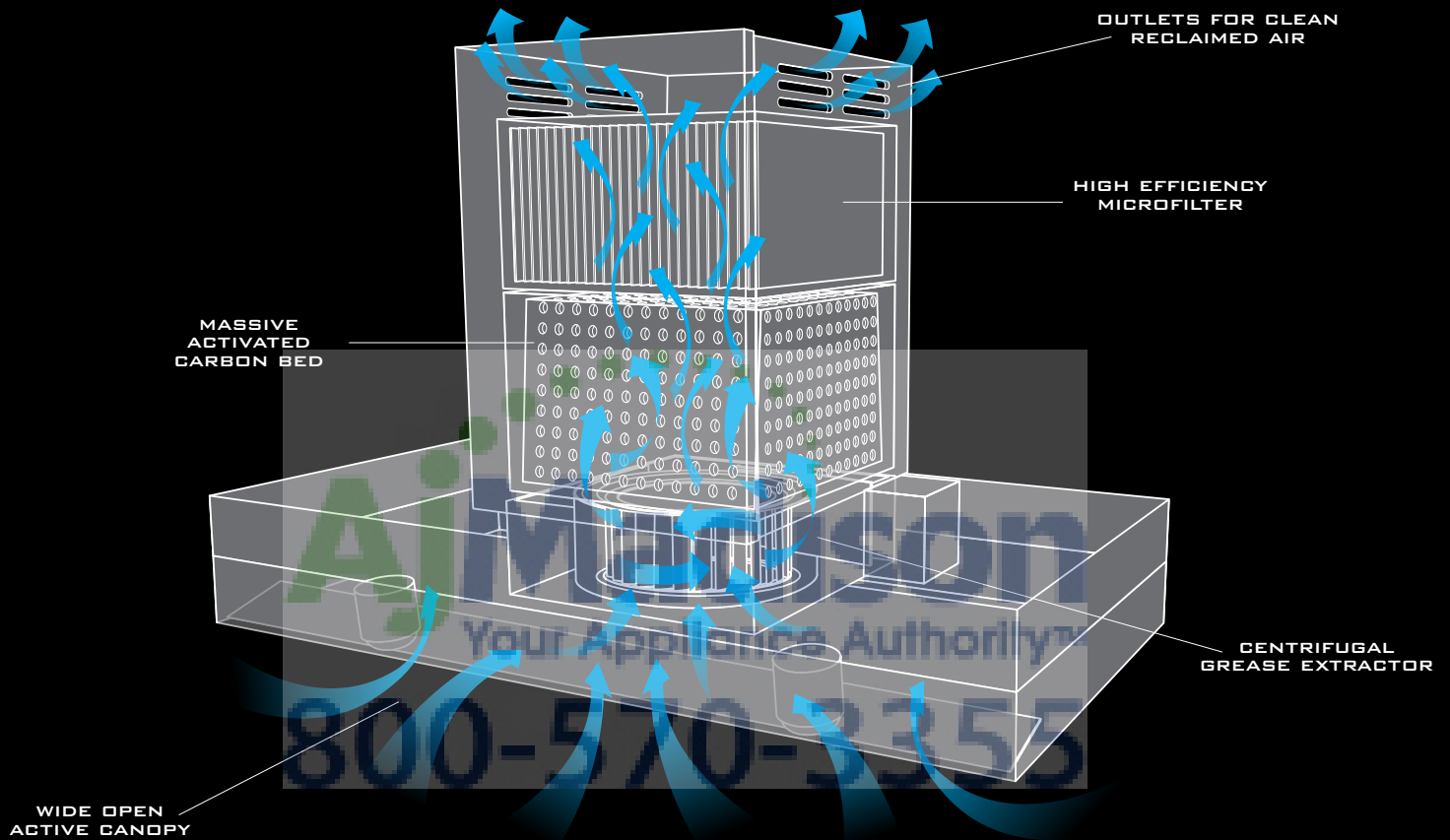

WHILE CONVENTIONAL DUCTLESS HOODS RETURN CONTAMINATES INTO THE KITCHEN, A DUCT-FREE VENT-A-HOOD IS DIFFERENT. THE 4-PHASE ARS PATENT-PENDING PROCESS SYSTEMATICALLY ELIMINATES CONTAMINANTS, RECLAIMING THE AIR AND RETURNING IT CLEAN AND FRESH INTO THE KITCHEN.

PHASE 1 ACTIVE CANOPY TECHNOLOGY EFFECTIVELY CAPTURES COOKING VAPORS

PHASE 2 CENTRIFUGAL GREASE EXTRACTOR REMOVES GREASE FROM AIR STREAM

PHASE 3 MASSIVE ACTIVATED CARBON BED HAS 50 TIMES MORE EXPOSURE THAN CONVENTIONAL DUCTLESS HOODS

PHASE 4 HIGH EFFICIENCY MICROFILTER USES INTERCEPTION, IMPACTION AND DIFFUSION PROCESS TO CAPTURE EVEN MINUTE SMOKE PARTICLES

AND BECAUSE THE 4 PHASE PROCESS WORKS SO WELL, YOUR HOME INTERIOR, INCLUDING FURNISHINGS AND FABRICS, STAY CLEANER AND LAST LONGER.

REMOTE BLOWER SYSTEM

- ROOF MOUNT OR WALL MOUNT APPLICATION
- FINISHED IN A DURABLE GUNSMOKE GRAY POWDER COATING
- INCLUDES A SCREEN TO PREVENT DEBRIS AND ANIMALS FROM ENTERING THE DUCTING
- POWERFUL 1000 AND 1500 CFM MODELS AVAILABLE
- COMPATIBLE WITH VARIABLE SPEED CONTROL FOR MAXIMUM EFFICIENCY



THE BBQ EXTENSION KIT

- CAN BE ATTACHED TO MOST STANDARD 18" TALL HOODS
- AVAILABLE IN POPULAR STANDARD OR CUSTOM PAINT COLORS AND STAINLESS STEEL
- THE EXTENSION KIT EXTENDS THE BLOWER OVER THE COOKING SURFACE FOR BETTER PERFORMANCE
- SAVE THE COST OF BUILDING OUT THE WALL FOR INSTALLATION

EXTENSION

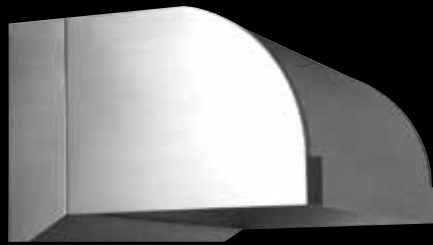

Hood



EXTENSION KIT



ACCESSORIES



OPTIONAL PULLOUT
E-Z CLEAN GREASE TRAYS



ALL-IN-ONE WARMING SHELF
& SPICE RACK



ACCESSORY RAIL

OR CUSTOMIZE YOUR OWN HOOD

- CHOOSE YOUR STYLE & DEPTH: 27", 30", 33" OR ANY CUSTOM DEPTH
- SINGLE INSTALLATION PROCESS
- MORE CANOPY SPACE FOR BETTER PERFORMANCE
- AVAILABLE IN ANY CUSTOM DEPTH
- SAVE THE COST OF BUILDING OUT THE WALL FOR INSTALLATION

Madison
Your Appliance Authority
800-570-3355

OPTIONAL FEATURES



LIGHTS

- HALOGEN LIGHTS (H MODELS) – STANDARD IN MOST MODELS SHOWN. 50-WATT HALOGEN LIGHTS COME WITH A DUAL SWITCH FOR DIMMING TO 25 WATTS. BULBS INCLUDED. FOR HOODS 24” TO 41” WIDE, TWO LIGHTS; 42” TO 53” WIDE, THREE LIGHTS; 54” TO 66” WIDE, FOUR LIGHTS. EACH ISLAND HOOD HAS FOUR HALOGEN LIGHTS, ONE IN EACH CORNER. FLUORESCENT LIGHTS ARE AVAILABLE IN PLACE OF HALOGEN LIGHTS. FLUORESCENT MODELS DO NOT HAVE SENSASOURCE. REPLACEMENT BULBS OR ALTERNATE BULB TYPES (FLUORESCENT OR LED) MAY BE OBTAINED FROM YOUR LOCAL HARDWARE OR LIGHTING STORE.
- WARMING LIGHT BAR (WBAR MODEL) – AVAILABLE IN MOST 18” TALL AND TALLER WALL-MOUNT HOODS. LIGHT BAR HOUSING IS MADE OF STAINLESS STEEL IN ALL HOODS. BULBS NOT INCLUDED. NOT AVAILABLE IN ISLAND OR EURO-STYLE HOODS.
- WARMING LIGHT HOUSING (WL-1 MODEL) – AVAILABLE IN SELECTED UNDER-CABINET MODELS. LIGHT HOUSING IS MADE OF STAINLESS STEEL IN ALL HOODS. BULBS NOT INCLUDED. NOT AVAILABLE IN ISLAND OR EURO-STYLE HOODS.



SHELVES

- WARMING SHELVES – INCLUDE FOLD-DOWN WIRE SHELVES AND STAINLESS STEEL BACKSPLASH. SHELVES ARE 14” WIDE AND 10” DEEP. BACKSPLASH IS 15” HIGH AND EXTENDS THE WIDTH OF THE HOOD. LEDGE IS 3-1/2” DEEP.



RAILS

- POT RAIL - 5/8” DIAMETER BRASS, CHROME OR COPPER RAILS ADD A BEAUTIFUL EFFECT TO ANY STYLE HOOD. SPECIFY POT RAIL FOR FRONT AND/OR SIDES ON UNDER-CABINET AND WALL-MOUNT HOODS. SPECIFY POT RAIL FOR FRONT AND/OR BACK, SIDES OR ALL AROUND ISLAND HOODS (ISLAND HOOD ILLUSTRATED).



- STAINLESS STEEL GALLEY RAIL IS INCLUDED STANDARD ON CWLH9 AND CILH9 HOODS. ALSO AVAILABLE AS AN OPTION ON OTHER SELECTED MODELS.



- FIXED LENGTH STAINLESS STEEL RAIL IS INCLUDED STANDARD ON GTH, ZTH AND IZTH HOODS. ALSO AVAILABLE AS AN OPTION ON OTHER SELECTED MODELS.



ACCESSORY RAILS

- THE ACCESSORY RAIL IS A NEW FEATURE FROM VENT-A-HOOD® THAT IS MULTI-FUNCTIONAL AND INTERCHANGEABLE. IT CAN BE POSITIONED AS A WARMING SHELF OR A SPICE RACK. THE KIT INCLUDES MOUNTING HARDWARE, ACCESSORY RAIL, TWO HANGER BRACKETS AND TWO WARMING SHELVES AND/OR SPICE RACKS. FOR USE ON ALL UNDER CABINET AND WALL MOUNT HOODS. IT CAN BE INSTALLED WITH A WALL MOUNT LINER BY ATTACHING BRACKET TO ADJACENT CABINETS. SHELVES ARE 10 1/2” DEEP BY 13 1/2” WIDE AND SPICE RACK IS 4 1/4” DEEP BY 13 1/2” WIDE.



FINISHES

- STANDARD POWDER-COAT SMOOTH PAINT FINISHES – BISCUIT, GUNSMOKE, SATIN BLACK OR WHITE. ALSO AVAILABLE IN CUSTOM COLORS; ASK FOR THE VENT-A-HOOD® CUSTOM COLOR CHART
- SPECIAL POWDER-COAT TEXTURED PAINT FINISHES* – BLACK RIVER, COPPER VEIN**, GOLD VEIN**, SILVER VEIN OR WHITE RIVER
- STAINLESS STEEL
- METAL OVERLAY*** – REAL BRASS, REAL COPPER, HAMMERED COPPER, ANTIQUED COPPER OR ANTIQUED HAMMERED COPPER. POWDER-COAT PAINT INTERIOR STANDARD. STAINLESS STEEL INTERIOR AVAILABLE UPON REQUEST, ADDITIONAL CHARGES WILL APPLY.

* ADDITIONAL CHARGE APPLIES.

** THESE PAINT COLORS ARE USED FOR INTERIOR COLORS ON REAL COPPER OR REAL BRASS HOODS. IF DESIRED, THE ENTIRE HOOD CAN BE PAINTED WITH THESE COLORS. ADDITIONAL CHARGES WILL APPLY.

*** REAL BRASS, REAL COPPER AND HAMMERED COPPER HOODS OXIDIZE AND/OR TARNISH OVER TIME, AND THEREFORE WILL REQUIRE REGULAR POLISHING. ANTIQUED COPPER AND ANTIQUED HAMMERED COPPER FINISHES DO NOT REQUIRE REGULAR POLISHING. POLISHING ANTIQUED FINISHES WILL REMOVE THE PATINA.



BANDS

- VERTICAL BANDS- 1" OR 2" 18-GAUGE VERTICAL BANDS. BANDS ARE LAMINATED TO THE HOOD STANDARD. MAY BE ATTACHED WITH RIVET CAPS OR HEX NUTS UPON REQUEST. 1" OR 2" 24-GAUGE VERTICAL BANDS ARE ALSO AVAILABLE. BANDS ARE ATTACHED TO HOOD WITH EITHER RIVET CAPS OR HEX NUTS.



- 1/4" THICK COPPER VERTICAL BANDS. HEAVY BANDS ARE ATTACHED TO HOOD USING LARGE COPPER RIVETS.

LIP TREATMENT



- A BAND OF ANY OF THE PAINT FINISHES OR METALS CAN ALSO BE ATTACHED TO THE FRONT OF THE LIP.

- 24-GAUGE LIP TREATMENT PARTIALLY "REVEALS" THE LIP AROUND THE BEVELED EDGES. ATTACHED TO HOOD WITH EITHER RIVET CAPS OR HEX NUTS. CANNOT BE USED IN CONJUNCTION WITH POT RAIL.

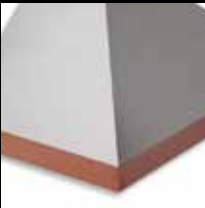

- 18-GAUGE LIP TREATMENT WITH FULL- LIP COVERAGE. LIP TREATMENT IS LAMINATED TO THE HOOD STANDARD. MAY BE ATTACHED WITH RIVET CAPS OR HEX NUTS UPON REQUEST. MAY BE USED IN CONJUNCTION WITH POT RAIL.

BACKSPLASHES

- AVAILABLE IN STANDARD AND CUSTOM SIZES. AVAILABLE IN CHECKERED, DIAMOND OR PLAIN.

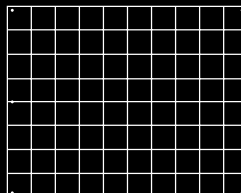

CHECKERED

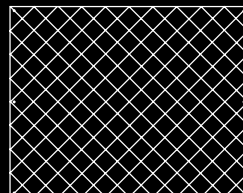

DIAMOND

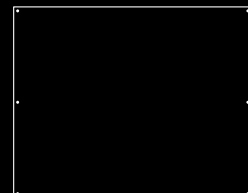

PLAIN

SPECIAL ORDER AND CUSTOMIZED RANGE HOODS

TO PERFECTLY COMPLEMENT THE STYLE OF YOUR KITCHEN, VENT-A-HOOD® OFFERS THE ADDITIONAL STYLES DESCRIBED ON THESE TWO PAGES. ADDITIONALLY, VENT-A-HOOD® HAS LONG BEEN A LEADER AT PROVIDING CUSTOMIZED SOLUTIONS FOR SPECIAL REQUIREMENTS, WHETHER MINOR MODIFICATIONS TO EXISTING PRODUCTS OR MORE SUBSTANTIAL TECHNOLOGICAL AND AESTHETIC INNOVATIONS.

UNDER CABINET

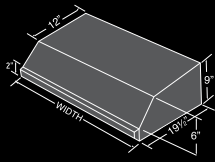

SL6/SLH6 EMERALD
6" TALL FRONT ON THIS UNDER-CABINET HOOD PROVIDES AN IDEAL REPLACEMENT WHERE LOW CABINET HEIGHT IS A PROBLEM AND HIGH PERFORMANCE IS REQUIRED. NOTE: 9" TALL BACK. THE SLH6-K IS ALSO AVAILABLE FOR STANDARD ELECTRIC COOKING EQUIPMENT. SEE PAGE 6 FOR DETAILS.

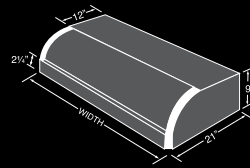

XR9/XRH9 EXCALIBUR
UNIQUELY EUROPEAN UNDER-CABINET HOOD COMBINES A ROUNDED SHAPE WITH BOLD, BLACK BANDS. NOTE THAT BLACK BANDS ARE STANDARD, ALTERNATE FINISHES AVAILABLE.

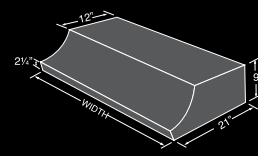

F FLAIRLINE
TRADITIONAL UNDER-CABINET MODEL WORKS WELL IN ANY KITCHEN DESIGN. FLUORESCENT LIGHTS ONLY.

WALL-MOUNT

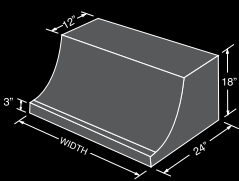

DA18/DAH18 FLAIRLINE
CLASSIC DESIGN OF THIS WALL-MOUNT HOOD FITS ANY KITCHEN. CHOOSE VERTICAL ENDS THAT ARE PERFECT FOR INSTALLATION BETWEEN CABINETS, OR OPTIONAL CONCAVE ENDS FOR A FRENCH COUNTRY LOOK.

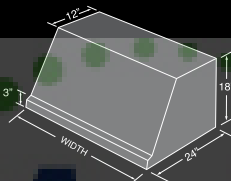

PWV18/PWVH18 SLOPELINE
CLEAN SLOPE AND DEFINED FRONT LIP CREATE A TRADITIONAL WALL-MOUNT DESIGN THAT CAN HAVE EITHER VERTICAL OR OPTIONAL SLOPED ENDS FOR BETWEEN-CABINET AND FREESTANDING INSTALLATIONS.

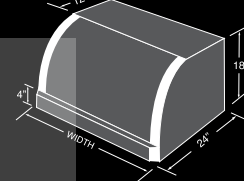

XR18/XRH18 EXCALIBUR
BOLD, BLACK BANDS AND ROUNDED SHAPE OF THIS EUROPEAN WALL-MOUNT HOOD CREATE A UNIQUE DESIGN. BLACK BANDS ARE STANDARD, ALTERNATE FINISHES AVAILABLE. OPTIONAL CONVEX ENDS ARE ALSO AVAILABLE TO COMPLETE THE "BARREL SHAPE" ON ALL THREE SIDES. 27" BOTTOM DEPTH ALSO AVAILABLE.

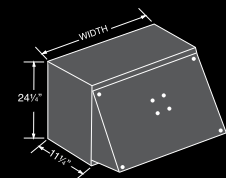

TLH/TILT
TILT-OUT WALL-MOUNT HOOD IS FRONTED WITH YOUR CABINET MATERIAL TO PROVIDE VISUAL CONTINUITY OF CABINETRY. THE HOOD CAN EASILY BE PULLED OUT WHEN NEEDED AND PUSHED CLOSED WHEN NOT IN USE.

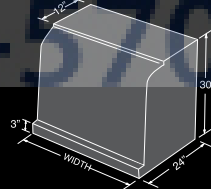

CX30/CXH30 CONVEX
EUROPEAN DESIGN OF THIS ROUNDED WALL-MOUNT HOOD WORKS WELL IN ANY KITCHEN. OPTIONAL CONVEX ENDS ARE ALSO AVAILABLE TO COMPLETE THE "BARREL SHAPE" ON ALL THREE SIDES.

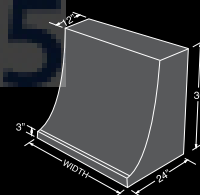

DA30/DAH30 FLAIRLINE
CONCAVE SHAPE ON THIS CLASSIC WALL-MOUNT DESIGN LOOKS GREAT IN ANY KITCHEN. CHOOSE VERTICAL ENDS THAT ARE PERFECT FOR INSTALLATION BETWEEN CABINETS, OR OPTIONAL CONCAVE ENDS FOR A FRENCH COUNTRY LOOK.

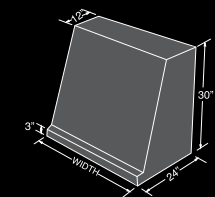

PWV30/PWVH30 SLOPELINE
CLEAN SLOPE AND DEFINED FRONT LIP CREATE A TRADITIONAL WALL-MOUNT DESIGN THAT CAN HAVE EITHER VERTICAL OR OPTIONAL SLOPED ENDS FOR BETWEEN-CABINET AND FREESTANDING INSTALLATIONS.

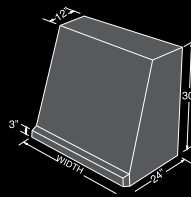

SL30/SLH30 EMERALD
THE POPULAR UP-TO-DATE CONTEMPORARY DESIGN OF THIS WALL-MOUNT HOOD WITH SOFT-CUT CORNERS HAVE EITHER VERTICAL OR OPTIONAL SLOPED ENDS FOR BETWEEN-CABINET AND FREESTANDING INSTALLATIONS.

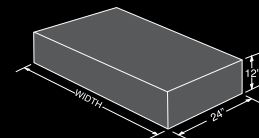

CW/CWH CONTEMPORARY
STAND-ALONE HOOD CAN HAVE OPTIONAL CLIPPED OR ROUNDED CORNERS. ADD OPTIONAL OFFSETS TO CREATE A LIP. OPTIONAL SQUARE, RECTANGULAR OR ROUNDED DUCT COVERS ARE ALSO SMART ADDITIONS.

ISLAND

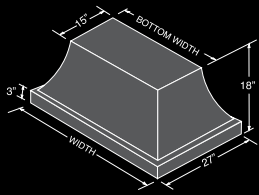

ISF18/ISFH18 FLAIRLINE
CONCAVE ISLAND DESIGN COMPLEMENTS ANY
STYLE KITCHEN.

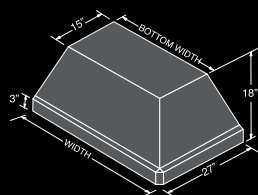

ISL18/ISLH18 EMERALD
SOFT-CUT CORNERS AND CONTEMPORARY
DESIGN MAKE THIS A STRIKING ISLAND HOOD.

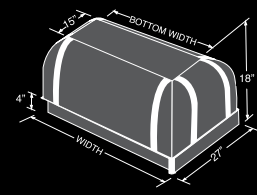

IXR18/IXRH18 EXCALIBUR
EUROPEAN DESIGN OF THIS ISLAND HOOD IS
STANDARD WITH BLACK BANDS, ALTERNATE
FINISHES AVAILABLE.

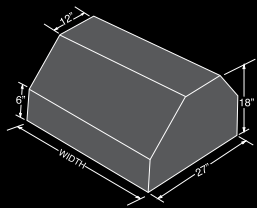

PL18/PLH18 PROFESSIONAL
LINEAR STYLED ISLAND HOOD ACCENTS THE
PROFESSIONALLY-STYLED KITCHEN.

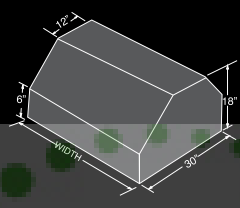

PLX18/PLXH18 PROFESSIONAL
LINEAR STYLED ISLAND HOOD ACCENTS THE
PROFESSIONALLY-STYLED KITCHEN.

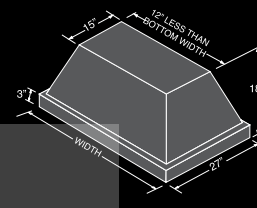

PY18/PYH18 SLOPELINE
ISLAND HOOD WITH CLASSIC FREESTANDING
DESIGN WORKS WELL IN ANY KITCHEN.

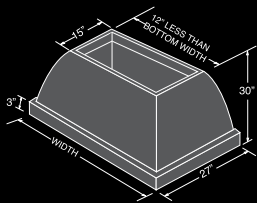

ICX30/ICXH30 CONVEX
UNIQUELY EUROPEAN ISLAND HOOD WITH
ROUNDED SHAPE COMPLEMENTS ANY DESIGN
SETTING.

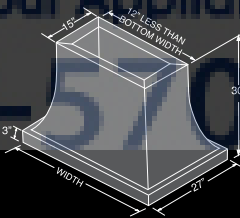

ISF30/ ISFH30 FLAIRLINE
CONCAVE ISLAND DESIGN COMPLEMENTS ANY
STYLE KITCHEN.

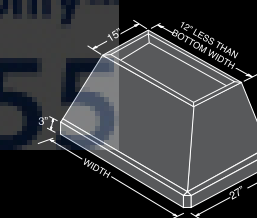

ISL30/ISLH30 EMERALD
SOFT-CUT CORNERS AND CONTEMPORARY
DESIGN MAKE THIS A STRIKING ISLAND HOOD.

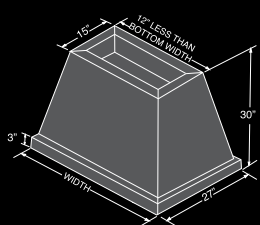

PY30/PYH30 SLOPELINE
ISLAND HOOD WITH CLASSIC FREESTANDING
DESIGN WORKS WELL IN ANY KITCHEN.

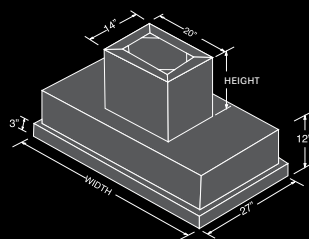

CO/COH STRAIGHTLINE
STRONGLY RECTANGULAR DESIGN WITH OR
WITHOUT LIP OFFSETS (OPTIONAL) CAN BE
MODIFIED WITH OPTIONAL CLIPPED OR
ROUNDED CORNERS. OPTIONAL RECTANGULAR,
SQUARE AND ROUND DUCT COVERS CAN NICELY
COMPLEMENT THIS ISLAND HOOD.

NOTE: BASE MODEL NUMBERS WITH AN "H" HAVE
HALOGEN LIGHTS; THOSE WITHOUT AN "H" HAVE
FLUORESCENT LIGHTS.

9" UNDER-CABINET HOODS ARE RECOMMENDED TO
MOUNT 24"- 27" ABOVE THE COOKING SURFACE AND
6" UNDER-CABINET HOODS ARE RECOMMENDED TO
MOUNT 21"- 24" ABOVE THE COOKING SURFACE.

WALL-MOUNT HOODS ARE RECOMMENDED TO
MOUNT 30" ABOVE THE COOKING SURFACE (EXCEPT
TLH/TILT, WHICH IS RECOMMENDED TO MOUNT
23-3/4" ABOVE THE COOKING SURFACE).

ISLAND HOODS ARE RECOMMENDED TO MOUNT 30"
ABOVE THE COOKING SURFACE.

ALL VENT-A-HOOD® RANGE HOODS ARE SUITABLE
FOR USE IN COVERED OUTDOOR APPLICATIONS WHEN
INSTALLED IN A GFCI PROTECTED BRANCH CIRCUIT.

FOR MORE DETAILED SPECIFICATION INFORMATION,
SEE OUR WEB SITE, WWW.VENTAHOOD.COM

HOW TO CHOOSE YOUR VENT-A-HOOD® RANGE HOOD

ANSWER THE FOLLOWING QUESTIONS TO FOCUS YOUR SEARCH ON THE VENT-A-HOOD® THAT IS APPROPRIATE FOR YOUR NEEDS. YOU WILL MATCH YOUR COOKING EQUIPMENT WITH THE CORRECT VENTILATION. THE SPECIFICATIONS BELOW APPLY TO RESIDENTIAL COOKING EQUIPMENT ONLY. ADDITIONAL SPECIFICATION CONSIDERATIONS MAY BE REQUIRED FOR OUTDOOR COOKING EQUIPMENT.

WHAT TYPE OF COOKING EQUIPMENT DO YOU HAVE?

- STANDARD ELECTRIC
 STANDARD GAS
 PROFESSIONAL-STYLE

WHAT TYPE OF HOOD DO YOU NEED?

- UNDER-CABINET
 WALL-MOUNT
 ISLAND
 LINER INSERT (WALL-MOUNT OR ISLAND)

WHAT SIZE OF MAGIC LUNG® BLOWER DO YOU REQUIRE?

THERE'S NO EXACT SCIENCE FOR DETERMINING YOUR BLOWER REQUIREMENTS—IF YOU NEVER HAVE ALL YOUR BURNERS ON AT ONCE, YOU DON'T NEED TO BUY EXCESSIVE CAPACITY. TO LOCATE ON THE FOLLOWING CHART THE MAGIC LUNG® BLOWER THAT'S APPROPRIATE FOR YOU, CONSIDER THE TYPE OF HOOD YOU WANT, THE TYPE OF EQUIPMENT YOU USE, AND YOUR COOKING HABITS—WHETHER YOU USE ALL OR ONLY PART OF THE BTU/WATT VALUE OF THE COOKING EQUIPMENT.

HOOD TYPE	COOKING EQUIPMENT	MULTI-BURNER COOKTOP RATING* (BTU/WATTS)	BBQ, WOK OR GRIDDLE (BTU/WATTS)	MAGIC LUNG® BLOWER(S)*	EQUIVALENT CFM
WALL-MOUNT OR UNDER-CABINET	STANDARD ELECTRIC SMALL GAS	12,000 WATTS	12,000 WATTS	240 CFM K SERIES BLOWER 300 CFM B100 SINGLE BLOWER	360 CFM 450 CFM
UNDER-CABINET	STANDARD GAS	40,000-60,000 BTU 24,000 WATTS	40,000 BTU 24,000 WATTS	600 CFM (B200 DUAL BLOWER)	900 CFM
WALL-MOUNT	STANDARD GAS OR PROFESSIONAL-STYLE	40,000-60,000 BTU	40,000 BTU 24,000 WATTS	600 CFM (B200 DUAL BLOWER)	900 CFM
WALL-MOUNT	HEAVY-USAGE PROFESSIONAL-STYLE	60,000-90,000 BTU	60,000 BTU 36,000 WATTS	900 CFM (ONE B100 SINGLE BLOWER PLUS ONE B200 DUAL BLOWER)	1350 CFM
WALL-MOUNT	48" OR 60" PROFESSIONAL-STYLE	80,000-120,000 BTU	80,000 BTU 48,000 WATTS	1200 CFM (TWO B200 DUAL BLOWERS)	1800 CFM
ISLAND	STANDARD ELECTRIC, GAS OR PROFESSIONAL-STYLE	40,000-60,000 BTU	40,000 BTU 24,000 WATTS	550 CFM (T200 ISLAND DUAL BLOWER)	900 CFM
ISLAND	HEAVY-USAGE PROFESSIONAL-STYLE	80,000-120,000 BTU	80,000 BTU 48,000 WATTS	1100 CFM (T400 ISLAND CLUSTER BLOWER)	1800 CFM

BECAUSE THE MAGIC LUNG® USES CENTRIFUGAL FILTRATION UNITS RATHER THAN CONVENTIONAL BAFFLE OR MESH FILTERS, THE MAGIC LUNG® BLOWER CAN HANDLE COOKING EQUIPMENT WITH HIGHER CUBIC FEET PER MINUTE (CFM) REQUIREMENTS AND CAN DELIVER EQUIVALENT CFM MUCH MORE EFFICIENTLY THAN OTHER FILTRATION SYSTEMS. WHEN COMPARING THE MAGIC LUNG® WITH BLOWER UNITS MADE BY OTHER MANUFACTURERS, USE THE "EQUIVALENT CFM."

*MULTI-BURNER COOKTOPS ARE NOT GENERALLY OPERATED AT FULL CAPACITY, WHEREAS BBQs, WOKS AND GRIDDLES ARE OFTEN OPERATED AT FULL CAPACITY.

MODEL NUMBER DECODING:

HERE IS AN EXPLANATION OF OUR MODEL NUMBER CODES: EX. PRH18-236 SS

- IN THIS EXAMPLE, PR IS THE MODEL. OTHER EXAMPLES ARE SL, EP, ETC.
- H MEANS THE HOOD HAS HALOGEN LIGHTS. NO H MEANS THE HOOD HAS FLUORESCENT LIGHTS.
- 18 IS THE HOOD HEIGHT IN INCHES.
- 2 IS THE NUMBER OF BLOWER MOTORS.
- 36 IS THE HOOD WIDTH IN INCHES.
- SS DESIGNATES THE FINISH.
SS — STAINLESS STEEL
BL — PAINTED BLACK
OL — OVERLAY, EITHER REAL BRASS, REAL COPPER OR HAMMERED COPPER.*

*IT IS NECESSARY TO SPECIFY EXTERIOR METAL AND INTERIOR COLOR WHEN THE FINISH IS OVERLAY.

WHAT HEIGHT HOOD DO YOU NEED?

THE HOOD HEIGHT IS DEPENDENT UPON THE RECOMMENDED DISTANCE BETWEEN YOUR COOKING SURFACE AND YOUR CABINET, SOFFIT OR CEILING. THE MOST COMMON APPLICATIONS ARE LISTED BELOW BUT WE HAVE A HOOD OR A HOOD AND DUCT COVER COMBINATION FOR NEARLY EVERY SITUATION.

NOTE: EXCEEDING THE RECOMMENDED MAXIMUM MOUNTING HEIGHT MAY COMPROMISE PERFORMANCE. SEE THE RECOMMENDED HEIGHT ILLUSTRATION FOR YOUR CHOSEN HOOD.

- 6" UNDER CABINET – FOR A 27" TO 30" SPACE BETWEEN COOKING SURFACE AND MOUNTING SURFACE (SEE ILLUSTRATIONS ON PAGE 6)
- 9" UNDER CABINET – FOR A 30" TO 33" SPACE BETWEEN COOKING SURFACE AND MOUNTING SURFACE (SEE ILLUSTRATIONS ON PAGES 7-9 AND 40)
- 18" WALL MOUNT OR ISLAND – FOR A 48"+ SPACE BETWEEN COOKING SURFACE AND MOUNTING SURFACE (SEE ILLUSTRATIONS ON PAGES 10-12, 15-17 AND 40-41)
- 30" WALL MOUNT OR ISLAND – FOR A 60"+ SPACE BETWEEN COOKING SURFACE AND MOUNTING SURFACE (SEE ILLUSTRATIONS ON PAGES 40-41)
- OTHER

WHAT WIDTH HOOD DO YOU NEED?

WHEREVER POSSIBLE, THE WIDTH OF UNDER-CABINET AND WALL-MOUNT HOODS SHOULD OVERLAP THE BURNERS 3"- 6" ON EACH SIDE. ISLAND HOODS MUST OVERLAP BY 3"- 6" FOR PROPER PERFORMANCE. VENT-A-HOOD® RANGE HOODS CAN BE MANUFACTURED TO WIDTHS WITHIN 1/8".

- 30" ■ 36" ■ 42" ■ 48"
- 54" ■ 60" ■ 66" ■ OTHER

WHAT DEPTH HOOD DO YOU NEED?

THE HOOD SHOULD BE DEEP ENOUGH TO FULLY COVER ALL BURNERS.

- UNDER-CABINET
 - 19-1/2" OR 21" (STANDARD)
 - OTHER
- WALL-MOUNT
 - 24" (FOR STANDARD AND MOST PROFESSIONAL-STYLE COOKING EQUIPMENT)
 - 27" (FOR SOME PROFESSIONAL-STYLE COOKING EQUIPMENT)
 - OTHER
- ISLAND HOOD
 - 27" (FOR STANDARD COOKING EQUIPMENT)
 - 30" (FOR PROFESSIONAL-STYLE COOKING EQUIPMENT)
 - OTHER

WHAT STYLE OF VENT-A-HOOD® RANGE HOOD DO YOU DESIRE?

ON THE PREVIOUS PAGES OF THIS CATALOG, YOU SEE A VARIETY OF VENT-A-HOOD RANGE HOOD STYLES AND MODELS. UNDER CABINET HOODS ARE SHOWN ON PAGES 6-9, STANDARD WALL MOUNT HOODS ON PAGES 10-12, EURO-STYLE WALL MOUNT HOODS ON PAGES 13-17, CONTEMPORARY WALL MOUNT HOODS ON PAGES 18-23, EURO-STYLE ISLAND HOODS ON PAGES 24-25, CONTEMPORARY ISLAND HOODS ON PAGES 26-28, LINER INSERTS ON PAGES 29-31 AND ARS DUCT-FREE HOODS ON PAGES 34-35. EXAMPLES OF SPECIAL ORDER HOODS ARE AVAILABLE ON PAGES 40-41. OPTIONS, DECORATIVE FEATURES AND FINISHES ARE DESCRIBED ON PAGES 36-39.

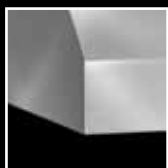

PROFESSIONAL



EMERALD



NOUVEAU PRO

FOR MORE DETAILED SPECIFICATION INFORMATION, REFERENCE OUR SEPARATE SPECIFICATION CATALOG OR VISIT OUR WEB SITE AT WWW.VENTAHOOD.COM



5

YEAR WARRANTY

**THE VENT-A-HOOD®
MAGIC LUNG® WARRANTY**

THE WARRANTY FOR VENT-A-HOOD® MAGIC LUNG® PRODUCTS IS FIVE YEARS ON THE MATERIAL AND WORKMANSHIP AND FIVE YEARS ON THE INTERNAL MOTOR(S). SEE WWW.VENTAHOOD.COM FOR DETAILS.

NOTE: K-SERIES, M-SERIES, AND REMOTE BLOWER PRODUCTS CARRY A ONE-YEAR WARRANTY.

AjMadison
Your Appliance Authority™
800-570-3355

VentAhood®

P.O. Box 830426
1000 N. GREENVILLE AVE.
RICHARDSON, TX 75083-0426
800-331-2492
WWW.VENTAHOOD.COM