

*Use and care*

# GUIDE

Professional Series Pro Grand<sup>®</sup> Ranges



*Use and care*  
**GUIDE**

Professional Series Pro Grand® Ranges

Table of contents (English) ..... 4

**Models:**

- PRD364WDGU
- PRD364WIGU
- PRD364WLGU
- PRD366WGU
- PRD484WCGU
- PRD486WDGU
- PRD486WIGU
- PRD486WLGU



# *Home Connect™ user's information*

## **Wi-Fi® module**

### **FCC/IC statements**

Model: COM2  
FCC ID: 2AHES-COM2  
IC: 21152-COM2

The Home Connect module is a communication device designed to provide communication between appliances and smart devices.

This module is integrated at the factory, under direct control of BSH Home Appliances Corporation, and is not user serviceable or upgradable. At least 20 cm separation distance should be maintained from device to user.

### **FCC COMPLIANCE STATEMENT**

CAUTION: Changes or modifications not expressly approved could void your authority to use this equipment.

This device complies with Part 15 of the FCC Rules. Operation to the following two conditions: (1) This device may not cause harmful interference, and (2) This device must accept any interference received, including interference that may cause undesired operation.

### **INDUSTRY CANADA STATEMENT**

This device complies with Industry Canada licence-exempt RSS standard(s). Operation is subject to the following two conditions: (1) this device may not cause interference, and (2) this device must accept any interference, including interference that may cause undesired operation of the device.

Operation in the band 5150-5250 MHz is only for indoor use to reduce the potential for harmful interference to co-channel mobile satellite systems.

Le présent appareil est conforme aux CNR d'Industrie Canada applicables aux appareils radio exempts de licence. L'exploitation est autorisée aux deux conditions suivantes : (1) l'appareil ne doit pas produire de brouillage, et (2) l'utilisateur de l'appareil doit accepter tout brouillage radioélectrique subi, même si le brouillage est susceptible d'en compromettre le fonctionnement.

Le fonctionnement dans la plage de 5150 à 5250 MHz est uniquement pour une utilisation intérieure afin de réduire le potentiel d'interférences nuisibles aux systèmes de satellites mobiles sur les canaux.

## *Congratulations!*

Congratulations on your recent Thermador purchase! Whether you are a dedicated chef or simply a connoisseur of the art of cooking, owning a Thermador kitchen is the ultimate expression of personal style, good taste and an appreciation for the complete culinary experience. Our award-winning products have been empowering culinary enthusiasts for more than eleven decades.



















Before you begin using your new Thermador product, please take a moment to review the Use and Care Guide. You will find the answers to all of your questions as well as some very important safety information. Pay special attention to the Important Safety Instructions located at the beginning of the manual. Your Thermador product is ready and waiting to be used for your next gourmet creation!

Our products are handcrafted with the highest quality authentic materials to ensure years of reliable service. In the unlikely event that you have a service question, please have your model and serial numbers of your product available (see the "Before calling for service" section for location).

We realize that you have made a considerable investment in your kitchen. Please feel free to share your Thermador kitchen photos and remodeling stories with us. Follow us on Twitter or post your kitchen photos on Facebook. We would love to hear from you!

Thermador wishes you many years of creative cooking.

# Table of CONTENTS

Safety .....	5
Important safety instructions .....	5
Description .....	11
Appliance identification .....	11
Before you begin .....	16
Getting started .....	16
Using the rangetop .....	18
Sealed STAR® burners .....	18
ExtraLow® burners .....	19
POWERBOOST® burner.....	19
Electric griddle .....	25
Electric grill .....	28
Using the oven.....	31
Symbols and descriptions.....	31
Initial start-up.....	32
Setting the oven(s).....	33
Timers   	33
Fast preheat 	34
Panel lock 	34
Convection conversion .....	35
Fine tuning the oven.....	35
Multi-point meat probe 	35
Sabbath 	36
Remote start 	38
Getting the most out of your appliance .....	39
Oven rack positions .....	39
Bake 	39
Broil 	40
Convection broil 	41
Convection bake 	41
True convection 	43
Proof 	43
Roast 	43
Convection roast 	44
Keep warm 	44
Setting up Home Connect™.....	45
Setup .....	45
Care and maintenance .....	47
Self-clean 	47

Appliance cleaning tips .....	48
Do-it-yourself maintenance .....	53
Oven light bulb replacement .....	53
Before calling for service .....	54
Troubleshooting .....	54
Service information .....	55
Remote customer service connection 	55
Product registration.....	55
Statement of limited product warranty .....	56
Support, accessories, and parts.....	back page

## Safety DEFINITIONS

### ▲ WARNING

This indicates that death or serious injuries may occur as a result of non-observance of this warning.

### ▲ CAUTION

This indicates that minor or moderate injuries may occur as a result of non-observance of this warning.

**NOTICE:** This indicates that damage to the appliance or property may occur as a result of non-compliance with this advisory.

**Note:** This alerts you to important information and/or tips.

*This THERMADOR® appliance is made by*  
 BSH Home Appliances Corporation  
 1901 Main Street, Suite 600  
 Irvine, CA 92614

*Questions?*  
 1-800-735-4328  
 www.thermador.com

*We look forward to hearing from you!*



# Safety

## ⚠ IMPORTANT SAFETY INSTRUCTIONS READ AND SAVE THESE INSTRUCTIONS

### Please read carefully

**Installer:** Please leave this guide with this unit for the owner.

**Owner:** Please retain this guide for future reference. Use the appliance only for its intended purpose as described in this manual.

#### WARNING

When properly cared for, your new appliance has been designed to be safe and reliable. Read all instructions carefully before use. These precautions will reduce the risk of burns, electric shock, fire, and injury to persons. When using kitchen appliances, basic safety precautions must be followed, including these in the following pages.

#### WARNING



If the information in this manual is not followed exactly, a fire or explosion may result causing property damage, personal injury or death.

- DO NOT store or use gasoline or other flammable vapors and liquids in the vicinity of this or any other appliance.
- WHAT TO DO IF YOU SMELL GAS
  - DO NOT try to light any appliance.
  - DO NOT touch any electrical switch.
  - DO NOT use any phone in your building.
  - Immediately call your gas supplier from a neighbor's phone. Follow the gas supplier's instructions.
  - If you cannot reach your gas supplier, call the fire department.
- Installation and service must be performed by a qualified installer, service agency or the gas supplier.

#### WARNING



#### DANGER OF TIPPING



- All ranges can tip and injury can result. To prevent accidental tipping of the range, attach it to the floor, wall, or cabinet by installing the anti-tip bracket supplied.
- A child or adult can tip the range over and be killed or seriously injured. Verify that the anti-tip bracket is securely installed. Ensure the anti-tip bracket is engaged when the range is moved.
- **DO NOT** operate the range without the anti-tip bracket in place. Failure to follow the instructions in this manual can result in death or serious burns to children and adults.
- If the range is pulled away from the wall for cleaning, service, or any other reason, ensure that the anti-tip bracket is properly reengaged when the range is pushed back against the wall. In the event of abnormal usage (such as a person standing, sitting, or leaning on an open door), failure to take this precaution can result in tipping of the range. Personal injury might result from spilled hot liquids or from the range itself.
- Check for proper installation and use of anti-tip bracket. Carefully tip range forward pulling from the back to ensure that the anti-tip bracket engages the range and prevents tip-over. Range should not move more than 1" (2.5 cm).

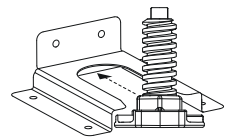

#### WARNING

Improper installation, adjustment, alteration, service or maintenance can cause injury or property damage. Refer to this manual. For assistance or additional information consult a qualified installer, service agency, manufacturer or the gas supplier.

#### WARNING

To provide proper ventilation of the range **DO NOT** remove range feet.

# ⚠ IMPORTANT SAFETY INSTRUCTIONS

## READ AND SAVE THESE INSTRUCTIONS

---

### WARNING

---

Before servicing or cleaning the unit, switch power off at service panel and lock service panel. This will prevent power from being switched on accidentally. When the service panel cannot be locked, securely fasten a prominent warning device, such as a tag to the service panel.

---

### Gas type verification

**Natural gas** – 7 in. water column (17.4 mb) min., 14 in. (34.9 mb) maximum

**Propane gas** – 11 in. water column (27.4 mb) min., 14 in. (34.9 mb) maximum

Verify the type of gas supplied to the location. Ensure that the appliance is connected to the type of gas for which it is certified. Refer to the data rating label.

---

### WARNING

---

If a gas conversion kit is used, the kit shall be installed by qualified technician in accordance with the manufacturer's instructions and all applicable codes and requirements of the authority having jurisdiction. If the information in the instructions is not followed exactly, a fire, explosion or production of carbon monoxide may result causing property damage, personal injury or loss of life. The qualified technician is responsible for the proper installation of the kit. The installation is not proper and complete until the operation of the converted appliance is checked as specified in the manufacturer's instructions supplied with the kit.

---

---

### CAUTION

---

When connecting the unit to propane gas, make certain the propane gas tank is equipped with its own high-pressure regulator in addition to the pressure regulator supplied with the appliance. The maximum gas pressure to this appliance must not exceed 14.0" water column (34.9 mb) from the propane gas tank to the pressure regulator.

---

#### For Massachusetts installations:

1. Installation must be performed by a qualified or licensed contractor, plumber or gas fitter qualified or licensed by the state, province or region where this appliance is being installed.
2. Shut-off valve must be a "T" handle gas cock.
3. Flexible gas connector must not be longer than 36" (914 mm).

Ensure proper installation and servicing. Follow the Installation Instructions provided with this product. Have the appliance installed and electrically grounded by a qualified technician.

In the event a burner goes out and gas escapes, open a window or a door. **DO NOT** attempt to use the appliance until the gas has had time to dissipate. Wait at least 5 minutes before using the appliance.

**DO NOT** repair or replace any part of the appliance unless specifically recommended in this manual. All servicing should be referred to an authorized servicer.

### Electrical requirements

---

### WARNING

---



#### IN CASE OF AN ELECTRICAL FAILURE

If for any reason a gas control knob is turned ON and there is no electrical power to operate the electronic igniters on the burners, turn OFF the gas control knob and wait 5 minutes for the gas to dissipate before lighting the burner manually.

To light the burners manually, carefully hold a lighted match to the burner ports and turn the gas control knob to HI. During a power failure, you can use the standard burners, but each must be lit with a match.

**DO NOT** attempt to light the XLO<sup>®</sup> burners manually. These burners are equipped with the ExtraLow<sup>®</sup> feature and cannot be lit manually.

---

The appliance must be electrically grounded in accordance with local codes or, in the absence of local codes, with the National Electrical Code, NFPA 70 or the Canadian Electric Code, CSA C22.1-02.

---

### WARNING

---

#### Never Operate the Top Surface Cooking Section of this Appliance Unattended

- Failure to follow this warning statement could result in fire, explosion, or burn hazard that could cause property damage, personal injury, or death.
  - If a fire should occur, keep away from the appliance and immediately call your fire department. **DO NOT ATTEMPT TO EXTINGUISH AN OIL/GREASE FIRE WITH WATER.**
-

# **IMPORTANT SAFETY INSTRUCTIONS**

## READ AND SAVE THESE INSTRUCTIONS

It is the personal responsibility and obligation of you, the user, to have this appliance connected to the electrical power supply by a qualified electrician, in accordance with the National Electrical Code and/or applicable local codes and ordinances.

Service should only be done by an authorized servicer.

Always disconnect the electrical plug from the wall receptacle before servicing this unit.

See the Installation Instructions for electrical requirements and grounding instructions.

Have the installer show you where the electric circuit breaker and the gas supply shut off valve are located so you know how and where to turn off the gas and electricity to the appliance.

Installation and maintenance must be carried out correctly. Follow the instructions in the Installation Instructions supplied with the product. Make sure that a qualified electrician installs and performs grounding of the appliance.

### **This appliance complies with the following Safety Codes and Standards:**

- UL 858, The Standard for the Safety of Household Electric Ranges
- ANSI Z21.1, The American National Standard for Household Cooking Gas Appliances
- CAN1-1.1-M81, Domestic Gas Ranges
- CSA C22.2 No. 61, Household Cooking Ranges

Installation must conform with local codes or, in the absence of local codes, with the National Fuel Gas Code, ANSI Z223.1/NFPA 54 or, in Canada, the Natural Gas and Propane Installation Code, CSA B149.1.

Installation of appliances designed for manufactured (mobile) home installation must conform with the Manufactured Home Construction and Safety Standard, Title 24 CFR, Part 3280 [formerly the Federal Standard for Mobile Home Construction and Safety, Title 24, HUD (Part 280)] or with local codes where applicable.

Installation of appliances designed for recreational park trailers must conform with state or other codes or, in the absence of such codes, with the Standard for Recreational Park Trailers, ANSI A119.5.

Clearances from non-combustible materials are not part of the ANSI Z21.1 scope and are not certified by CSA. Clearances under 6 inches should be approved by the local codes and/or by the local authority having jurisdiction.

It is the responsibility of the owner and the installer to determine if additional requirements and/or standards apply to specific installations.

The maximum depth of cabinets installed above cooking surface must be 13" (330 mm).

## Child safety

---

### **WARNING**

---

**DO NOT** store items of interest to children above or at the back of the appliance. If children should climb onto the appliance to reach these items, they could be seriously injured.

---

When children become old enough to use the appliance, it is the responsibility of the parents or guardians to ensure that they are instructed in safe operation of the appliance by qualified persons.

**DO NOT** allow anyone to climb, stand, lean, sit, or hang on any part of an appliance. This can damage the appliance, and the unit may tip over, potentially causing severe injury.

**DO NOT** allow children to use this appliance unless closely supervised by an adult.

Children and pets should not be left alone or unattended in the area where the appliance is in use. They should never be allowed to play in its vicinity, whether or not the appliance is in use.

## Proposition 65 Warning

This product may contain a chemical known to the State of California, which can cause cancer or reproductive harm. Therefore, the packaging of your product may bear the following label as required by California:

**State of California Proposition 65 Warning:**

 **WARNING**

Cancer and Reproductive Harm -  
[www.P65Warnings.ca.gov](http://www.P65Warnings.ca.gov)



# **IMPORTANT SAFETY INSTRUCTIONS**

## READ AND SAVE THESE INSTRUCTIONS

### General safety

---

#### **WARNING**

---

**To reduce the risk of injury to persons, in the event of a range top grease fire, observe the following:**

- Smother flames with a close-fitting lid, cookie sheet, or other metal tray, then turn off the gas burner or the electric element. Be careful to prevent burns. If the flames do not go out immediately, evacuate and call the fire department.
- Never pick up a flaming pan. You may be burned.
- **DO NOT** use water, including wet dish cloths or towels, to extinguish flames – a violent steam explosion will result.
- Use an extinguisher **ONLY** if:
  - You know you have a class ABC extinguisher and you already know how to operate it.
  - The fire is small and contained in the area where it started.
  - The fire department is being called.
  - You can fight the fire with your back to an exit.

---

#### **WARNING**

---

To eliminate risk of burns or fire caused by reaching over heated surface units, cabinet storage located above the surface units should be avoided.

---

#### **WARNING**

---

#### **TO REDUCE THE RISK OF A GREASE FIRE**

- Never leave surface units unattended at high settings. Boilovers cause smoking and greasy spillovers that may ignite. Heat oils slowly on low or medium settings.
- Always turn hood ON when cooking at high heat or when flambéing food (i.e. Crepes Suzette, Cherries Jubilee, Peppercorn Beef Flambé).
- Clean hood filters frequently. Grease should not be allowed to accumulate on fan or filter.
- Use proper pan size. Always use cookware appropriate for the size of the appliance burner.

**NEVER** use any part of the appliance for storage. Flammable materials can catch fire and plastic items may melt or ignite. **DO NOT** hang articles from any part of the appliance. Some fabrics are quite flammable and may catch on fire.

If the appliance is near a window, be certain the curtains do not blow over or near the appliance burners; they could catch on fire.

**ALWAYS** have a working smoke detector near the kitchen. In the event that personal clothing or hair catches fire, drop and roll immediately to extinguish flames.

Have an appropriate fire extinguisher available nearby, highly visible, and easily accessible near the cooking appliance.

Smother flames from food fires, other than grease fires, with baking soda. Never use water on cooking fires.

Whenever possible, do not operate the ventilation system during a fire. However, **DO NOT** reach through fire to turn it off.

**NEVER** let clothing, potholders, or other flammable materials come in contact with or too close to any burner or burner grate until it has cooled. Fabric may ignite and result in personal injury.

Use only dry potholders: moist or damp potholders on hot surfaces may cause burns from steam. **DO NOT** use a towel or other bulky cloth in place of potholders. **DO NOT** let potholders touch hot burners or burner grates.

For personal safety, wear proper apparel. Loose fitting garments or hanging sleeves should never be worn while using this appliance. Some synthetic fabrics are highly flammable and should not be worn while cooking.

**DO NOT** use aluminum foil to line any part of the appliance. Use of a foil liner could result in a shock or fire hazard, or the obstruction of the flow of combustion and ventilation air. Foil is an excellent heat insulator and heat will be trapped beneath it. This will upset the cooking performance and can damage the finish of the appliance.

---

#### **WARNING**

---

The appliance is for cooking. Based on safety considerations, never use the appliance to warm or heat a room. Doing so may result in carbon monoxide poisoning and overheating of the unit. Also, such use can damage the appliance parts.

When using the appliance: **DO NOT TOUCH THE BURNER GRATES OR THE IMMEDIATE SURROUNDING AREA.** Areas adjacent to the burners may become hot enough to cause burns.

# ⚠ IMPORTANT SAFETY INSTRUCTIONS

## READ AND SAVE THESE INSTRUCTIONS

Never leave the appliance unattended when using high flame settings. Boil overs cause smoking and greasy spillovers that may ignite. Also, if the burner flames and igniter are smothered with spillage, unburned gas will escape into the room. See page 5 regarding gas leaks.

Only certain types of glass, heatproof glass-ceramic, ceramic, earthenware, or other glazed cookware are suitable for cooking on the burners. This type of cookware may break with sudden temperature changes. Use only on low or medium heat settings according to the utensil manufacturer's directions.

**DO NOT** heat or warm unopened food containers. Build-up of pressure may cause the container to burst and cause injury.

---

### WARNING

---

During cooking, set the burner control so that the flame heats only the bottom of the pan and does not extend beyond the bottom of the pan. This instruction is based on safety considerations.

---

Use caution to ensure that drafts like those from forced air vents or fans do not blow flammable material toward the flames or push the flames so that they extend beyond the edges of the pot.

Always use pots and pans that have flat bottoms large enough to cover the burner. The use of undersized pots and pans could expose a portion of the flame and may result in ignition of clothing.

---

### WARNING

---

Avoid using high flame setting with a pan larger than the grate or with one that spans more than one burner, such as a griddle, for prolonged periods of time. This can result in poor combustion that generates harmful by-products.

---

**DO NOT** use pots or pans on the grill plate accessory (purchased separately). Bakeware, such as large casserole pans, cookie sheets, etc., should never be used on the accessory.

**DO NOT** use flammable cleaners to clean the appliance.

Remove the optional cutting board or griddle cover accessory, which is stored on top of the griddle plate, before operating the griddle or any adjacent burners.

**GREASE IS FLAMMABLE.** Let hot grease cool before attempting to handle it. Avoid letting grease deposits collect. Clean after each use.

For proper lighting and performance of the burners, keep the igniter ports clean. It is necessary to clean the ports when there is a boil over or when the burner does not light even though the electronic igniters activate.

Clean the appliance with caution. Avoid steam burns; **DO NOT** use a wet sponge or cloth to clean the appliance while it is hot. Some cleaners produce noxious fumes if applied to a hot surface. Follow directions provided by the cleaner manufacturer.

---

### WARNING

---

After a spill or boil over, turn off the burner and using caution due to possible hot surfaces, clean around the burner and burner ports. After cleaning, check for proper operation.

---

Be sure all controls are turned off and the appliance is cool before using any type of aerosol cleaner on or around the appliance. The chemical that produces the spraying action could, in the presence of heat, ignite or cause metal parts to corrode.

---

### WARNING

---

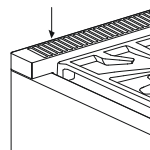

**DO NOT** block or obstruct the flow of air through the ventilation openings. The vent is located at the back of the appliance. The vent needs to be unobstructed and open to provide necessary airflow that is important for proper performance.

**DO NOT** touch vent area while the appliance is on and for several minutes after the appliance is off. Some parts of the vent and surrounding areas become hot enough to cause burns. Allow appliance sufficient time to cool before touching or cleaning vent areas.

**DO NOT** position plastic or other heat-sensitive items on or near the vent. These items could melt or ignite.

---

**DO NOT** obstruct the flow of combustion or ventilation air.

**DO NOT** use the grill plate accessory for cooking excessively fatty meats or products which promote flare-ups.

When cooking fatty or oily foods on burners, the grill, or the griddle, adjacent gas burners can ignite airborne fumes. Use caution to avoid burns.

To avoid a fire hazard, grease accumulation must be prevented by frequently cleaning the ventilation hood and filters.

# **IMPORTANT SAFETY INSTRUCTIONS**

## READ AND SAVE THESE INSTRUCTIONS

In case of fire or when intentionally “flaming” liquor or other spirits on the appliance, follow manufacturer’s instructions. Use caution when cooking foods with high alcohol content (e.g. rum, brandy, bourbon). Alcohol evaporates at high temperatures. There is a risk of burning as the alcohol vapors may catch fire. Use only small quantities of alcohol in foods.

**DO NOT** store or use corrosive chemicals, vapors, flammables, or nonfood products in or near this appliance. It is specifically designed for use when heating or cooking food. The use of corrosive chemicals while heating or cleaning will damage the appliance and could result in injury.

---

### **WARNING**

---

**DO NOT** leave food or cooking utensils, etc, in oven during the self-cleaning mode of operation. Before self-cleaning the oven (select models), remove the broiler pan, oven racks, and any other utensils, and excess spillage.

---

---

### **WARNING**

---

This appliance should not be installed with a ventilation system that directs air in a downward direction toward the appliance. This type of ventilation system may cause ignition and combustion problems with the appliance resulting in personal injury, property damage, or unintended operation. Ventilating systems that direct the air upwards do not have any restriction.

An air curtain or other overhead range hood, which operates by blowing a downward airflow onto a range, shall not be used in conjunction with a gas range unless the hood and range have been designed and tested in accordance with the Standard for Domestic Gas Ranges, ANSI Z21.1 • CSA 1.1, and listed by an independent testing laboratory for combination use.

---

**IMPORTANT:** There is a possibility to discolor the back wall under certain cooking conditions.

**DO NOT** clean, rub, damage, move or remove the door gasket. It is essential for a good seal during baking. If the gasket becomes worn or excessively soiled with food particles, replace gasket to assure a tight seal.

Protect the self-cleaning feature. Clean only those parts indicated in this booklet. **DO NOT** use commercial oven cleaners or oven liner protective coatings of any kind in or around the self-cleaning oven.

Place oven racks in desired position while oven is cool. If a rack must be moved while the oven is hot, do not let the potholders contact the broiler element.

**DO NOT TOUCH HEATING ELEMENTS OR INTERIOR SURFACES OF OVEN** – Heating elements may be hot even though they are dark in color. Interior surfaces of an oven become hot enough to cause burns. During and after use, do not touch, or let clothing or other flammable materials contact heating elements or interior surfaces of oven until they have had sufficient time to cool. Other surfaces of the appliance may become hot enough to cause burns - among these surfaces are oven vent openings and surfaces near these openings, oven doors, and windows of oven doors.

---

### **WARNING**

---

**NEVER** cover any slots, holes or passages in the oven bottom or cover an entire rack with materials such as aluminum foil. Doing so blocks air flow through the oven and may cause carbon monoxide poisoning. Aluminum foil linings may also trap heat, causing a fire hazard.

---

Use care when opening the oven door; let hot air or steam escape before removing or replacing foods.

Please note that some pets or humans can be sensitive to the odors created during the self-cleaning process whether it is a manufacturing residue burn off or food. It is recommended that those potentially affected be removed from the kitchen area during the self-clean process.

# Description

## Appliance identification

Model shown is 48" with griddle option (features will vary).

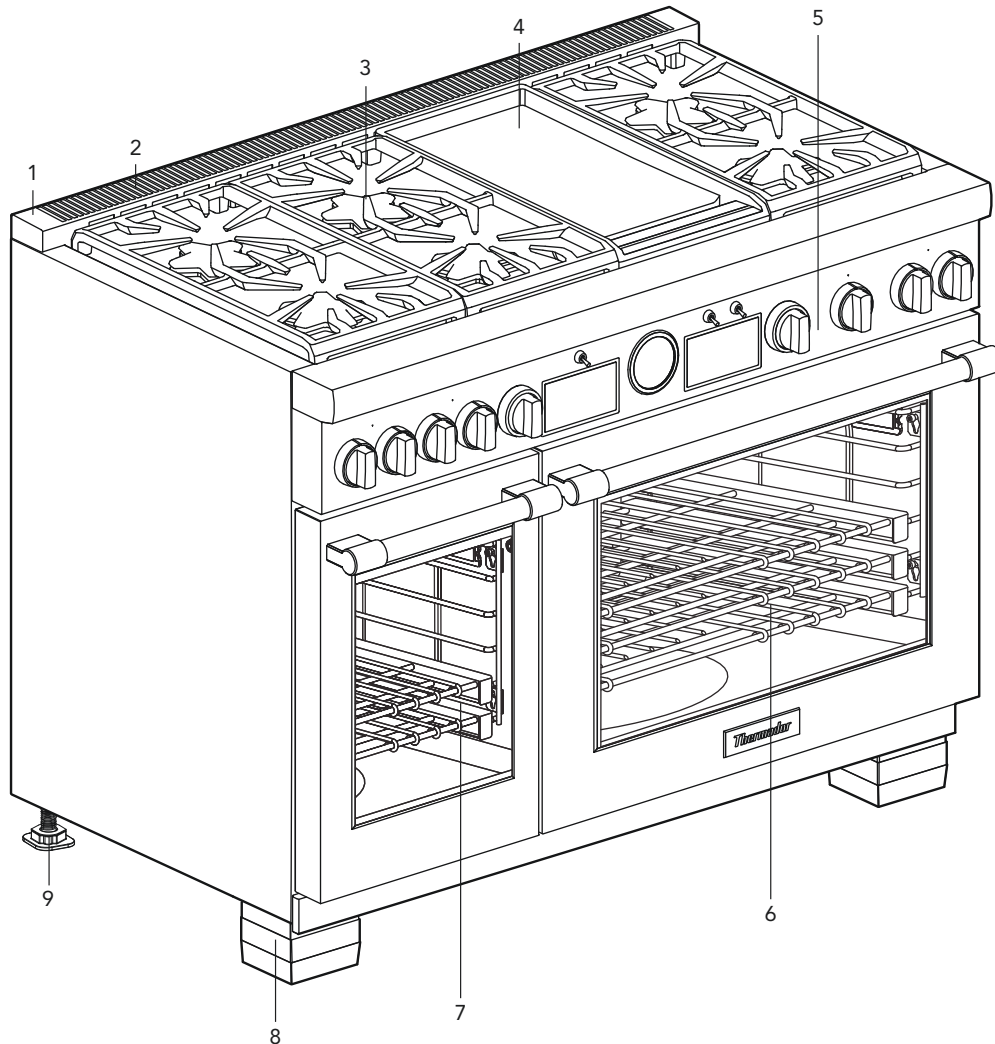

- 1 Island trim included or low backguard ordered separately  
(See Installation Instructions concerning spacing behind the range when using the range with the island trim.)
- 2 Oven vent (**DO NOT** obstruct!)
- 3 STAR® burners and grates
- 4 Griddle option (options will vary)
- 5 Control panel
- 6 Main oven
- 7 Secondary auxiliary oven (select models)
- 8 Leg covers  
(If additional leg covers are required, they may be ordered from the service center by calling 1-800-735-4328 at no charge for up to one year after purchase date of the appliance.)
- 9 Range feet

# Oven interior identification

## Dual fuel oven(s) interior

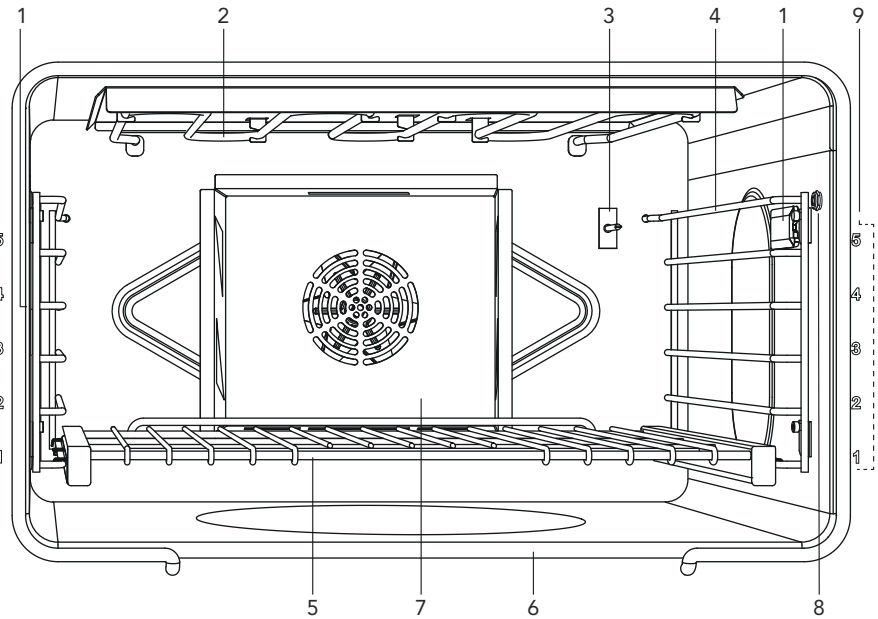
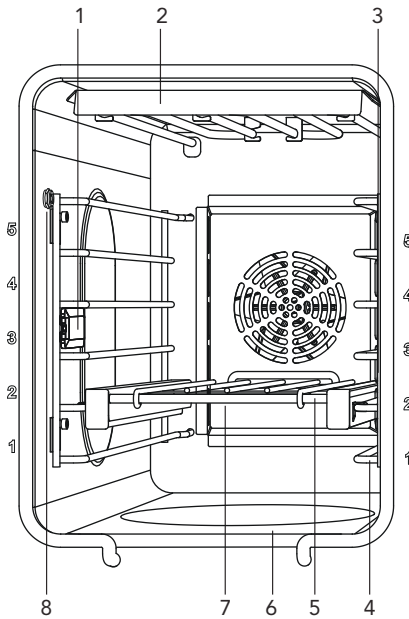

- 1 Oven interior light
- 2 Broil element
- 3 Oven thermostat
- 4 Rack guides
- 5 Oven racks

- 6 Bake element (hidden)
- 7 Convection fan cover
- 8 Meat probe outlet
- 9 Rack positions

## Gas oven(s) interior

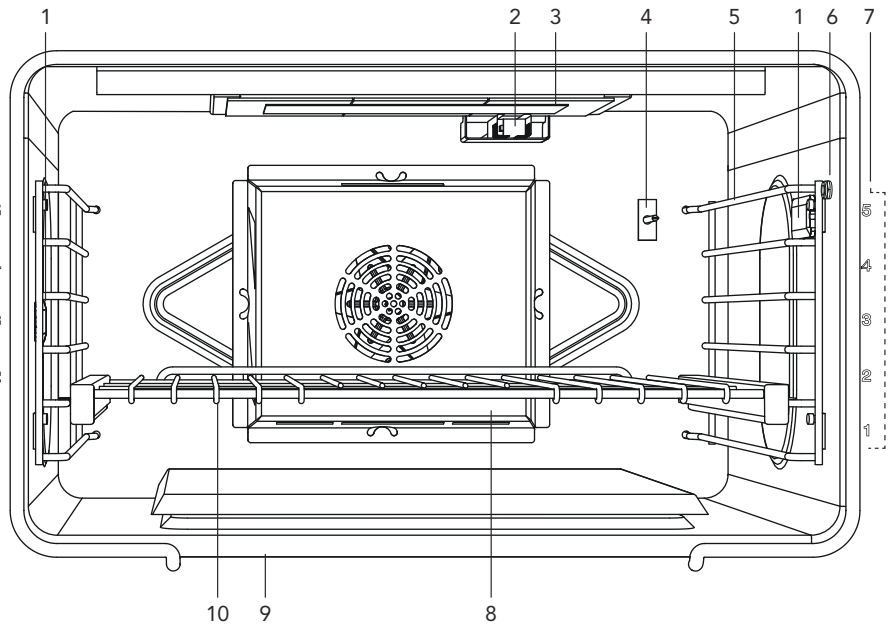
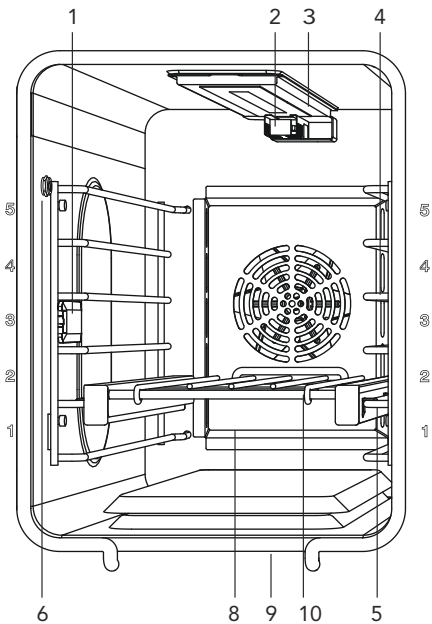



- 1 Oven interior light
- 2 Broil igniter
- 3 Infrared broil burner
- 4 Oven thermostat
- 5 Rack guides

- 6 Meat probe outlet
- 7 Rack positions
- 8 Convection fan cover
- 9 Bake burner (hidden)
- 10 Oven racks

# Control panel identification

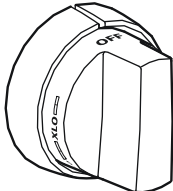
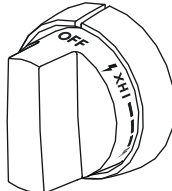
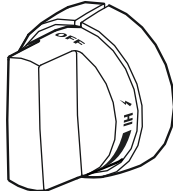
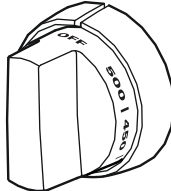
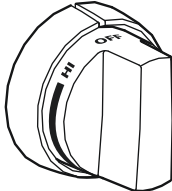
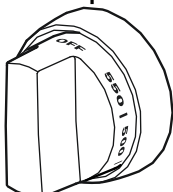
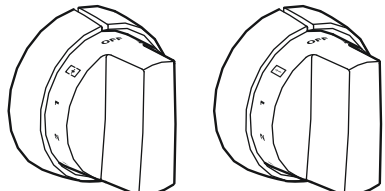
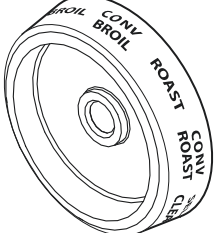
**NOTE:** Not all knobs, modes, and features are available to all models.

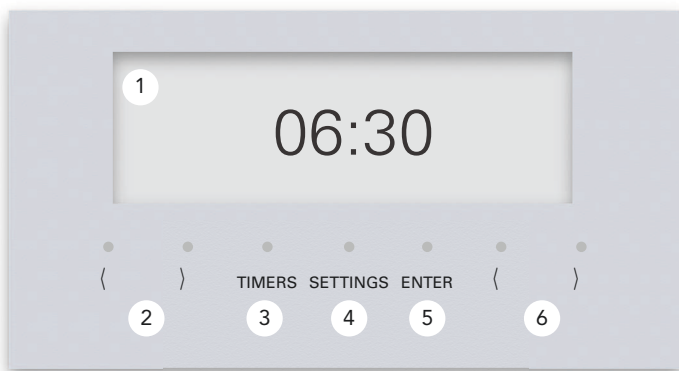
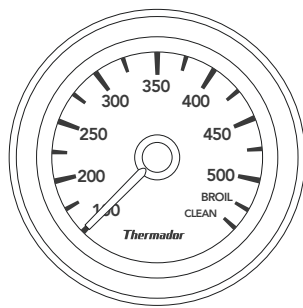
<p><b>ExtraLow®</b></p> 	<p><b>POWERBOOST®</b></p> 	<p><b>Standard</b></p> 	<p><b>Griddle</b></p> 	<p><b>Grill</b></p> 
<p><b>Oven temp selector</b></p> 	<p><b>Induction</b></p> 		<p><b>Mode selector</b></p> 	<p><b>Oven light switch</b></p> 
<p><b>Oven digital display</b></p>  <ol style="list-style-type: none"> <li>1 Digital display screen</li> <li>2 Left navigation buttons</li> <li>3 Access multiple timers</li> <li>4 Access user settings</li> <li>5 Confirm an entry</li> <li>6 Right navigation buttons</li> </ol>			<p><b>Oven temp gauge</b></p> 	



# Top surface identification

## Model 364 with induction

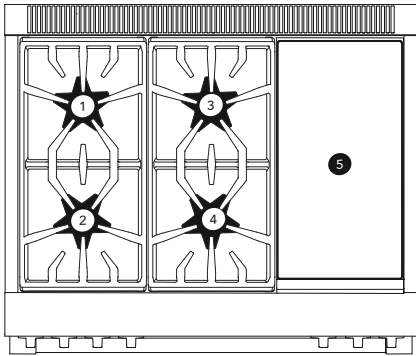

- |   |                                |                             |
|---|--------------------------------|-----------------------------|
| 1 | ExtraLow burner                | Natural 15000, LP 12000 BTU |
| 2 | ExtraLow and PowerBoost burner | Natural 22000, LP 18000 BTU |
| 3 | Standard burner                | Natural 15000, LP 12000 BTU |
| 4 | Standard burner                | Natural 18000, LP 15000 BTU |
| 5 | Induction                      | 3,600W                      |

## Model 364 with griddle

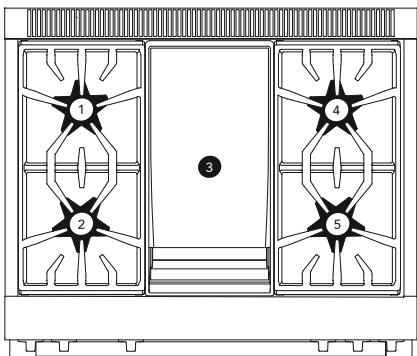

- |   |                                |                             |
|---|--------------------------------|-----------------------------|
| 1 | ExtraLow burner                | Natural 15000, LP 12000 BTU |
| 2 | ExtraLow and PowerBoost burner | Natural 22000, LP 18000 BTU |
| 3 | Griddle                        | 1,630W                      |
| 4 | Standard burner                | Natural 15000, LP 12000 BTU |
| 5 | Standard burner                | Natural 18000, LP 15000 BTU |

## Model 364 with grill

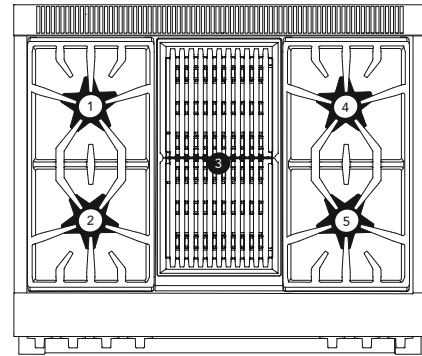

- |   |                                |                             |
|---|--------------------------------|-----------------------------|
| 1 | ExtraLow burner                | Natural 15000, LP 12000 BTU |
| 2 | ExtraLow and PowerBoost burner | Natural 22000, LP 18000 BTU |
| 3 | Grill                          | 815W x 2                    |
| 4 | Standard burner                | Natural 15000, LP 12000 BTU |
| 5 | Standard burner                | Natural 18000, LP 15000 BTU |

## Model 366

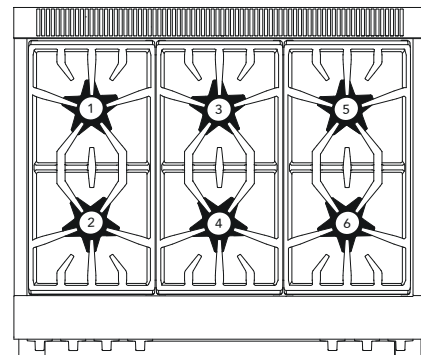

- |   |                                |                             |
|---|--------------------------------|-----------------------------|
| 1 | ExtraLow burner                | Natural 15000, LP 12000 BTU |
| 2 | ExtraLow and PowerBoost burner | Natural 22000, LP 18000 BTU |
| 3 | Standard burner                | Natural 15000, LP 12000 BTU |
| 4 | Standard burner                | Natural 18000, LP 15000 BTU |
| 5 | Standard burner                | Natural 15000, LP 12000 BTU |
| 6 | Standard burner                | Natural 18000, LP 15000 BTU |

**Model 486 with induction**

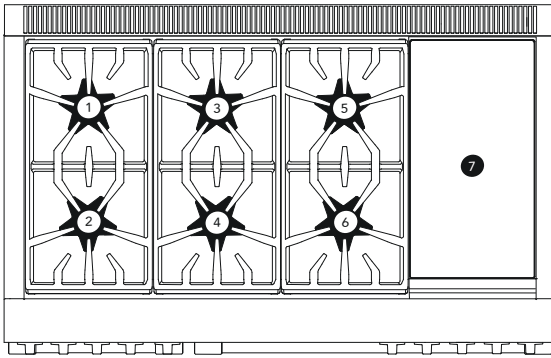

- |   |                                |                             |
|---|--------------------------------|-----------------------------|
| 1 | ExtraLow burner                | Natural 15000, LP 12000 BTU |
| 2 | ExtraLow and PowerBoost burner | Natural 22000, LP 18000 BTU |
| 3 | Standard burner                | Natural 15000, LP 12000 BTU |
| 4 | Standard burner                | Natural 18000, LP 15000 BTU |
| 5 | Standard burner                | Natural 15000, LP 12000 BTU |
| 6 | Standard burner                | Natural 18000, LP 15000 BTU |
| 7 | Induction                      | 3,600W                      |

**Model 486 with griddle**

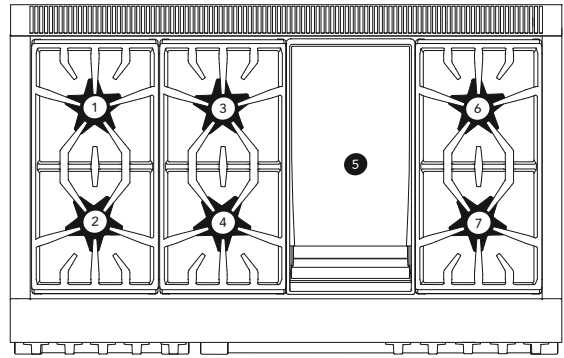

- |   |                                |                             |
|---|--------------------------------|-----------------------------|
| 1 | ExtraLow burner                | Natural 15000, LP 12000 BTU |
| 2 | ExtraLow and PowerBoost burner | Natural 22000, LP 18000 BTU |
| 3 | Standard burner                | Natural 15000, LP 12000 BTU |
| 4 | Standard burner                | Natural 18000, LP 15000 BTU |
| 5 | Griddle                        | 1,630W                      |
| 6 | Standard burner                | Natural 15000, LP 12000 BTU |
| 7 | Standard burner                | Natural 18000, LP 15000 BTU |

**Model 486 with grill**

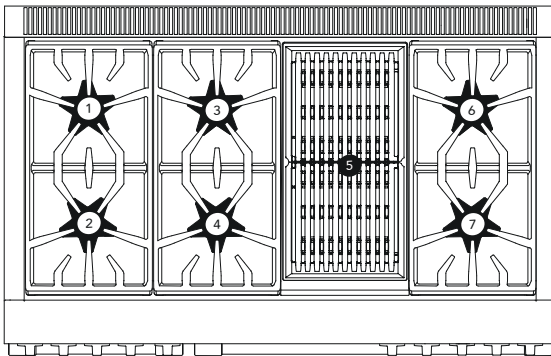

- |   |                                |                             |
|---|--------------------------------|-----------------------------|
| 1 | ExtraLow <sup>®</sup> burner   | Natural 15000, LP 12000 BTU |
| 2 | ExtraLow and PowerBoost burner | Natural 22000, LP 18000 BTU |
| 3 | Standard burner                | Natural 15000, LP 12000 BTU |
| 4 | Standard burner                | Natural 18000, LP 15000 BTU |
| 5 | Grill                          | 815W x 2                    |
| 6 | Standard burner                | Natural 15000, LP 12000 BTU |
| 7 | Standard burner                | Natural 18000, LP 15000 BTU |

**Model 486 with grill and griddle**

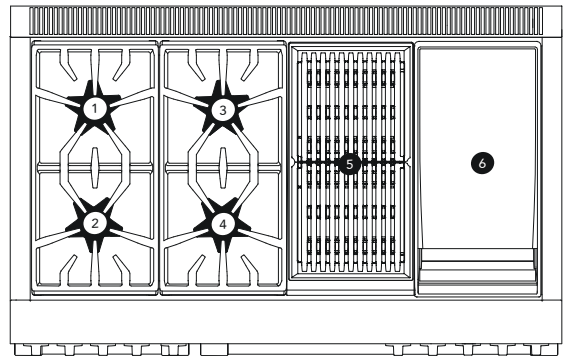

- |   |                                |                             |
|---|--------------------------------|-----------------------------|
| 1 | ExtraLow burner                | Natural 15000, LP 12000 BTU |
| 2 | ExtraLow and PowerBoost burner | Natural 22000, LP 18000 BTU |
| 3 | Standard burner                | Natural 15000, LP 12000 BTU |
| 4 | Standard burner                | Natural 18000, LP 15000 BTU |
| 5 | Grill                          | 815W x 2                    |
| 6 | Griddle                        | 1,630W                      |

# Before you begin

## Getting started

Due to our continuous improvement activities in design and quality improvements, some images may not be representative of the final product.

### Data rating label

- Record the model and serial number.
- The model and serial number must be provided when calling customer support for assistance.
- Register your BSH product to ensure timely service and access to your product related information. For product registration information see "Before calling for service".

### Surface burners

1. Ensure that the burner caps are correctly seated on the burner bases of the range's cooktop (see page 18).
2. Turn on each burner to check for proper flame color (see "Flame description" on page 20 for details).

### Oven racks

#### To install rack guides

1. Push the two rails in the holes in the back of the oven cavity.
2. Slide the guide's key slots over the shoulder bolts.
3. At the front of the oven cavity press down on the front of rack guide to clear the heads of the two shoulder bolts.

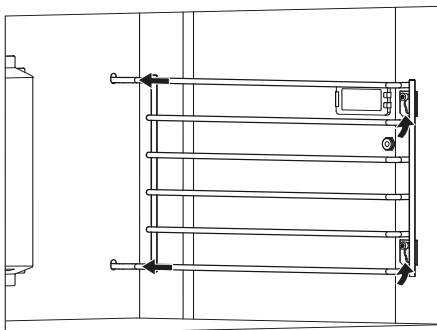

#### To install Full Access® racks

1. Hold the rack on a slight angle and place the safety hooks under the front of the rack guides.

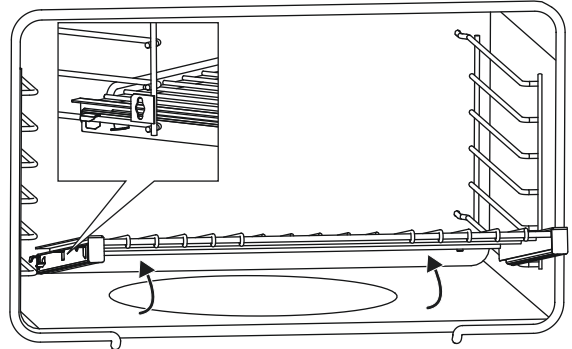

2. Push the rack into the oven, lifting the rack stops over the front of the rack guides.
3. Hold the rack straight.

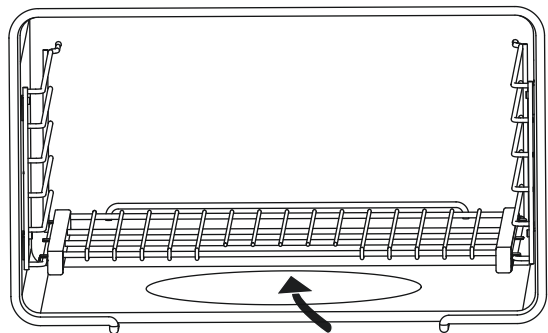

4. Push the rack in completely.
5. Engage the rack's front hooks on the rack guides.

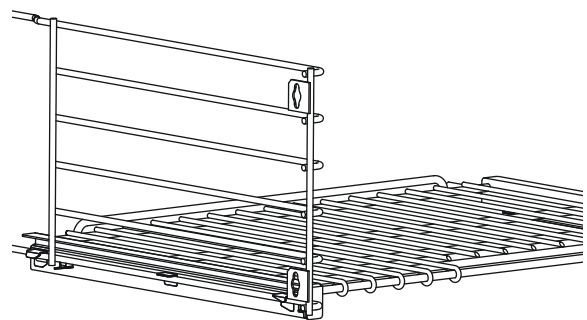

**IMPORTANT:** When placing the gliding rack in the oven, make sure the front supports on the rack guides rest in the large slots at the front corners of the rack. This is necessary to keep the rack in the correct position while fully inserted into the oven.

## To install flat racks

1. Grasp rack firmly on both sides and insert rack.
2. Tilt rack up to allow stop into rack guide.

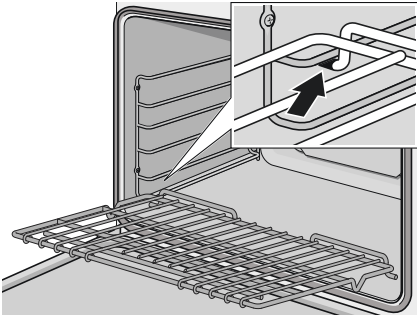

## Oven operation

---

### **⚠ WARNING**

---

To help prevent burns, never remove or reposition the oven racks while the oven is ON or while the oven is cooling.

---

### Positioning the oven racks

- The correct rack position depends on the recipe and the cooking mode.
- The rack positions are numbered from the bottom of the oven, like an elevator.
- Rack position 3 is the most frequently used position.
- Place rack(s) in the proper position before turning on the oven.

### Initial start-up

**IMPORTANT:** ALWAYS remove the oven racks before self-cleaning the oven. If the gliding racks remain in the oven during self-clean, lubricants in the glide mechanisms of each rack will be lost and the finish will discolor.

The range occasionally has an odor or smoke when first used. These odors or smoke comes from the burning off of manufacturing residues and is typical of any new oven regardless of manufacturer.

Before baking or broiling, the oven and broiler should be turned on to burn off the manufacturing oils using one of the two following methods:

1. Turn on kitchen ventilation (or if vent hood is a recirculation type open a window).
2. Turn the oven on to 450°F (230°C) for 20 to 30 minutes; then turn the broiler to broil for the same length of time.

or

1. Turn on kitchen ventilation (or if vent hood is a recirculation type open a window).
2. Remove oven racks.
3. Set oven to self-clean (select models).

### Automatic operation of the cooling fan

The cooling fan runs during all cooking modes. The fan can be heard when it is running, and warm air may be felt as it is released from the oven vent. The fan may also run after the oven is off.

### Oven vent

The oven vent is located at the back of the unit. Warm air may be released from the vent before, during and after cooking. It is normal to see steam escaping from the vent, and condensation may collect in this area. This area may be warm when the oven is in use. Do not block the vent, since it is important for air circulation.

### Convection fan

The convection fan operates during all convection modes. When the oven is operating in a convection mode, the fan turns off automatically when the door is opened. The convection fan may also run during self-clean.

# Using the rangetop

## Sealed STAR<sup>®</sup> burners

### ▲ WARNING

To prevent flare-ups and avoid the creation of harmful by-products, do not use the rangetop without all burner caps and all burner grates properly positioned.

### ▲ WARNING

To prevent burns, do not touch burner caps or grates while hot. Turn the rangetop off and allow the burners to cool.

## Burner cap placement

The burner caps must be properly placed on the burner bases for the cooktop to function properly. If the burner cap is not properly placed, one or more of the following problems may occur:

- Burner flames are too high.
- Flames shoot out of burners.
- Burners do not ignite.
- Burner flames light unevenly.
- Burner emits gas odor.

Each cap has a letter (B, D, or F) cast in the underside of the cap that corresponds to a letter (B, D, or F) cast in the burner base that is attached to the appliance.

### To place the burner caps

1. Place each burner cap on its correct burner base per its corresponding letter designation.

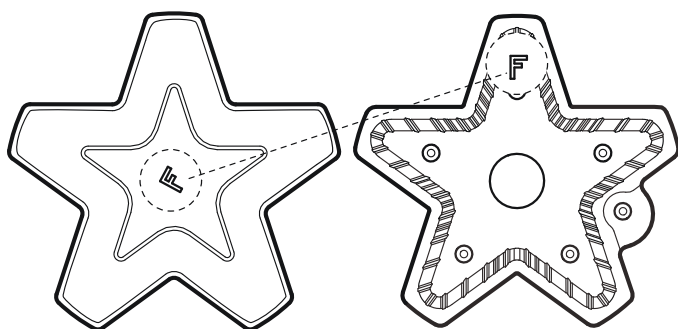

2. Place burner cap gently on top of base so that the prongs of the burner base fit snugly into the groove of the burner cap.

## Checking the burner cap placement

- Check each burner to make sure there is no gap between the burner cap and burner base.
- You may gently try to move the burner caps from side to side to check if the caps are properly placed on the burner bases.
- When properly placed, each burner cap will rest flat on top of its burner base, and completely cover the star-shape of the burner base when viewed from the top as shown below.

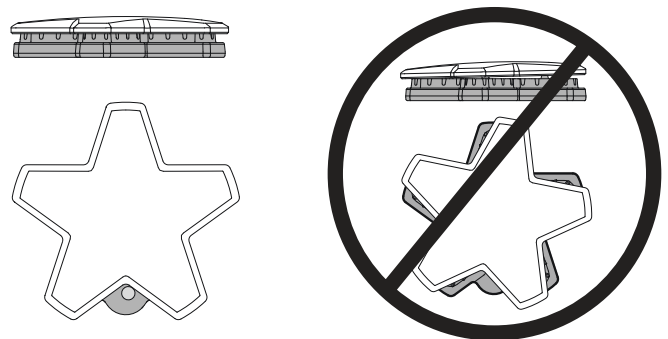

## Burner grate placement

### To install the burner grates

1. Place grates flat-side down and align into the rangetop recess.
2. Grates should rest flush against each other and against the sides of the recess.

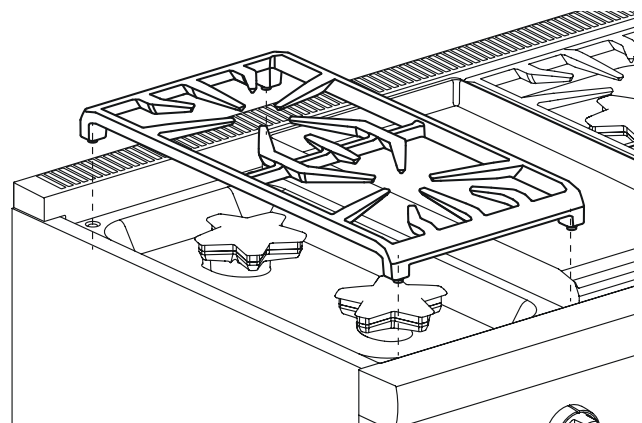

## Control knobs

The control knobs for two sealed gas burners, one in front and one in the rear, are located directly in front of and below the pair of burners on the control panel.

## Operation of the burners

### To turn on the burners

1. Press in on the knob and turn it counter-clockwise **HI**.
  - The igniter for the selected burner clicks and sparks.
  - After burner ignition, the igniter stops clicking.
2. Rotate the knob to any flame setting between **HI** and **LO**.

## LED panel light (select models)

Positioned below the bullnose, the LED panel light provides task lighting with a theatrical ambience.

The panel light toggle switch on the control panel turns the light on and off.

## ExtraLow® burners

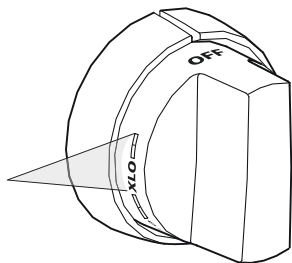

The drawing shows that the control knob has an additional range after the XLO setting. When the knob is set within this range, the flame cycles off and on.

By varying the length of time the flame is off and on, the heat is reduced even further to cook delicate foods. For example, these very low settings are suitable for simmering and poaching, melting chocolate and butter, holding cooked foods at temperatures without scorching or burning, etc.

## Operation of the ExtraLow® burners

- XLO, the very lowest setting, is achieved by cycling the flame on for approximately 10 seconds and off for 50 seconds of each minute.
- When the knob is set just below the XLO setting, the flame will cycle on for approximately 50 seconds and off for 10 seconds of each minute.
- To vary the amount of low heat to suit the food and quantity, the control can be set anywhere within the XLO range marked on the knob.

### ExtraLow® techniques

- To maintain a low or simmer heat, bring food to a rolling boil. Stir well, then cover the pan and lower the heat to a setting just below XLO.
- If a large pan is used, the simmer action may occur mainly in the center of the pan. To equalize the temperature throughout the food, stir the food around the outer edges of the pan into the food in the center.
- It is normal to stir food occasionally while simmering. This is especially important when simmering for several hours, such as for a homemade spaghetti sauce or beans.
- If the setting is too low to hold a simmer, bring the food back to a boil before re-setting to a higher heat.

## POWERBOOST® (select models)

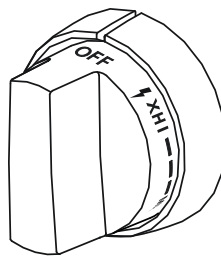

The POWERBOOST, or XHI, offers the convenience to quickly boil water, sear steaks, stir-fry vegetables, etc. Use of the LO and XLO remains the same as the other XLO knobs.



## Automatic re-ignition

---

### ▲ CAUTION

---

**DO NOT** touch the burners when the igniters are sparking.

---

Each burner has its own electronic igniter that sparks when the burner is turned on. Each burner should light in four seconds or less. If a burner does not light, check to see that the cap is positioned correctly on the base.

If any one or more burners blow out, the electronic igniter automatically activates to re-light the flame. Do not touch the burners when the igniters are active.

### IMPORTANT

- For proper combustion do not use the rangetop without the burner grates in place.
- There is a slight sound associated with gas combustion and ignition. This is a normal condition.
- On rangetops using propane gas (LP), a slight “pop” sound may be heard at the burner ports a few seconds after the burner has been turned off.

## Power failure

---

### ▲ WARNING

---

In the event of a power failure, turn all knobs to the OFF position. Only the standard burners can be lit manually.

---

- In the event of a power failure, only the standard burners can be manually lit. It is necessary to light each one individually.
- If the rangetop is being used when the power failure occurs, turn all knobs to the OFF position.
- The standard burners can be lit by holding a match at the ports and turning the control knob to the HI position. Wait until the flame is burning all around the burner cap before adjusting the flame to the desired height.
- The burners with the ExtraLow<sup>®</sup> feature cannot be used during a power failure. Be sure to turn them off.
- If a burner with ExtraLow is on when a power failure occurs, it cannot be turned back on until the knob is first turned off.
- If you smell gas, refer to safety precautions listed in the Safety chapter.

## Flame height

- The correct flame height depends on 1) size and material of pan being used; 2) food being cooked; and 3) amount of liquid in the pan.
- Never extend the flame beyond the base of the pan.
- Use a low or medium flame for pan materials that conduct the heat slowly, such as porcelain coated steel or glass-ceramic.

## Flame description

### Flame characteristics

Yellow flames:  
Further adjustment is required.

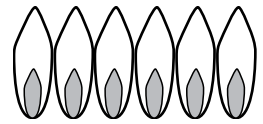

Yellow tips on outer cones:  
Normal for LP Gas

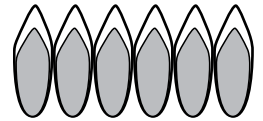

Soft blue flames:  
Normal for natural gas

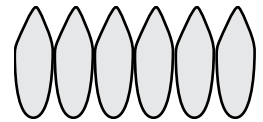

- If the flame is completely or mostly yellow, verify that the regulator is set for the correct fuel. After adjustment, retest.
- Some orange-colored streaking is normal during the initial start-up.
- The burner flame color should be blue with no yellow on the tips. It is not uncommon to see orange in the flame color; this indicates the burning of airborne impurities in the gas and will disappear with use.
- With propane (LP) gas, slight yellow tips on the primary cone are normal.
- The flame should burn completely around the burner cap. If it doesn't, check that the cap is positioned correctly on the base and that the ports are not blocked.
- The flame should be stable with no excessive noise or fluttering.

## Cookware recommendations

---

### ⚠ WARNING

---

To avoid risk of serious injury, damage to appliance or cookware, please observe the following:

---

- Bakeware, such as large casserole pans, cookie sheets, etc. should never be used on the rangetop.
- Placement of large stock pots should be staggered when used on the rangetop.

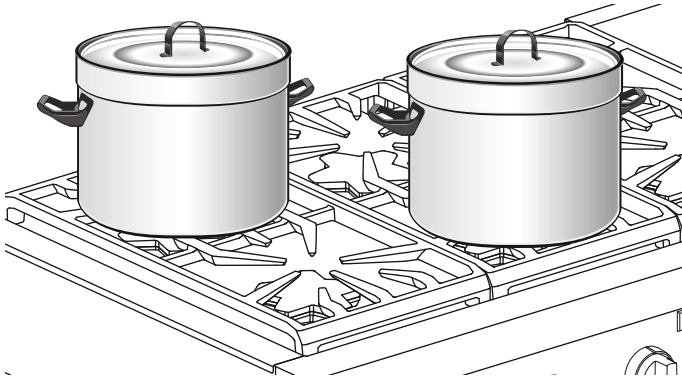

- Select the base diameter to match the diameter of the flame. The diameter of the flame should be the same size as the pan base or slightly smaller. Oversize or under size pans sacrifice cooking performance. A 5½" (140 mm) base size is generally the smallest recommended.
- Avoid using high flame setting with a pan larger than the grate or with one that spans more than one burner, such as a griddle, for prolonged periods of time. This can result in poor combustion that generates harmful by-products.
- Balance is important for stability and even cooking. The handle must not be heavier than the pan and tilt it unevenly. A pan must sit level on the grate without rocking or wobbling.



- Food packaged in aluminum foil should not be placed directly on the burner grate. Aluminum foil can melt during cooking.
- **DO NOT** let plastic, paper, or cloth come in contact with a hot burner grate. They may melt or catch fire.
- Professional quality pans with metal handles are recommended because plastic handles can melt or blister if the flame extends up the side of the pan.
- All cookware should have these characteristics: good heat conductivity, good balance, correctly sized base diameter, a heavy, flat base, and a proper fitting lid.
- For best cooking results, the flame should be contained under the bottom of the pan.
- Aluminum and copper are pan materials that conduct the heat quickly and evenly. These metals are sometimes attached to the base or in the core between stainless steel.
- A heavy, flat base is more apt to remain flat when heated. Pan bases that are warped, dented, ridged or too lightweight will heat unevenly. Heat and cool pans gradually to avoid sudden temperature changes which tend to distort cookware. **DO NOT** add cold water to a hot pan.

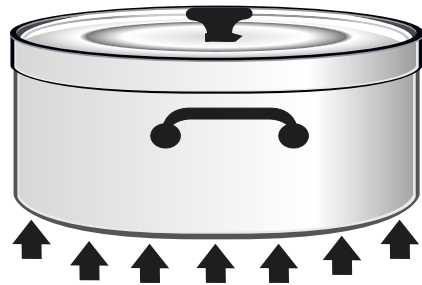

- A properly fitting lid will shorten cooking time and make it possible to use lower heat settings.

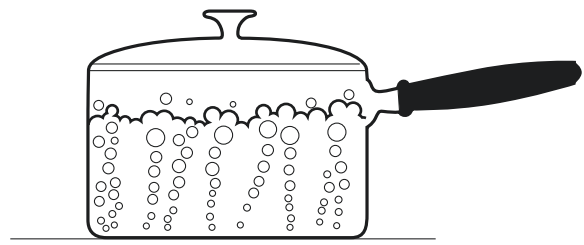

## Specialty cookware

### Woks

- Either flat-based or round-bottom woks with the accessory ring can be used on all models. Round bottom woks must be used with a support ring.
- The wok pan and the porcelain-coated cast iron wok support ring must be purchased separately.

### Canners and stock pots

- Select one with a base diameter that extends no more than 2" (51 mm) beyond the grate.

### Standard size water bath canner

- 21 to 22 quarts (19.95 to 20.9 liters), with an 11" to 12" base (279 – 305 mm) and a 9" to 11" depth (229 – 279 mm).

### Standard size pressure canner

- 8 to 22 quarts (7.6 to 20.9 liters), with an 8" to 11" base (203 – 279 mm) and a 6½" to 12" depth (165 – 305 mm).

### Canning tips

- A flat base pan is preferred to one with a concave, convex or rippled base.
- When using two canners at the same time, use staggered burners. **DO NOT** block air to the burners. A flame needs the right amount of air for complete combustion.
- Use a cover on the canner when bringing the contents to a boil.
- Once the contents have reached a boil on HI, use the lowest flame possible to maintain the boil or pressure.
- Canning produces a large amount of steam. Take precautions to prevent burns.

### Suggestions for using the surface burner cooking recommendations

- Use the chart beginning on page 23 as a guide. The settings you use will vary depending on the pans selected and the starting temperature of the food.
- On the chart, the "Finish setting" has been separated for the standard and ExtraLow<sup>®</sup> burners. There may or may not be a change between the two burner settings.
- The ExtraLow setting can be either a cooking or a holding setting.
- Raise or lower the flame setting gradually. Allow time for the pan and the food to adjust to the new setting.

## Surface burner cooking recommendations

Food	Start setting	Finish setting standard burners	Finish setting XLO® burners
Beverages Cocoa	MED – heat milk, cover	LO – finish heating	XLO – keep warm, cover
Breads French toast, pancakes, grilled sandwiches	MED – preheat skillet	LO to MED – cook	Same as for standard burners
Butter Melting	LO – to start melting		Allow 5 – 10 minutes to melt
Cereals Cornmeal, grits, oatmeal	HI – cover, bring water to a boil, add cereal	LO to MED – finish cooking according to package directions	Same as for standard burners XLO – to hold, cover
Chocolate Melting	XLO – may be stirred to hasten melting		XLO – allow 10 – 15 minutes to melt XLO – to hold
Desserts Candy	LO to MED – cook following recipe	LO to MED	Same as for standard burners
Pudding and pie filling mix	LO to MED LO – cook according to package directions	LO	Same as for standard burners
Pudding	LO to MED LO – bring milk to a boil	LO	Same as for standard Burners
Eggs Cooked in shell	MED HI – cover eggs with water, add lid, bring to boil		
Fried, scrambled	LO to MED – melt butter, add eggs	LO finish cooking	Same as for standard burners XLO – to hold for a short period
Poached	HI – bring water to the boiling point, add eggs	LO to MED – finish heating	Same as for standard burners
Meat, fish, poultry bacon, sausage patties	MED HI – until meat starts to sizzle	LO to MED – finish cooking	Same as for standard burners
Braising: Swiss steak, pot roast, stew meat	MED HI – melt fat, then brown on MED HI, add liquid, cover		XLO – Simmer until tender
Quick frying: Breakfast steaks	MED HI – preheat skillet	MED HI – fry quickly	Same as for standard burners
Frying: Chicken	MED HI – heat oil, then brown on MED	LO – cover, finish cooking	Same as for standard burners
Deep frying: Shrimp	MED HI – heat oil	MED to MED HI – to maintain temperature	Same as for standard burners
Pan frying: Lamb chops, thin steaks, hamburgers, link sausage	MED HI – preheat skillet	MED – brown meat	Same as for standard burners XLO – to hold
Poaching: Chicken, whole or pieces, fish	MED HI – Cover, bring liquids to a boil		To finish cooking

<b>Food</b>	<b>Start setting</b>	<b>Finish setting standard burners</b>	<b>Finish setting XLO® burners</b>
Simmering: Stewed chicken, corned beef, tongue, etc.	HI – cover, bring liquid to a boil		XLO – to simmer slowly XLO – to hold, cover
Pastas Macaroni, noodles, spaghetti	HI – bring water to a boil, add pasta	MED HI to HI – to maintain a rolling boil	Same as for standard burners
Popcorn (use a heavy, flat bottom pan)	HI – cover, heat until kernels start to pop	MED HI – finish popping	Same as for standard burners
Pressure cooker Meat	MED HI to HI – build up pressure	LO to MED – maintain pressure	Same as for standard burners
Vegetables	HI – build up pressure	LO to MED – maintain pressure	Same as for standard burners
Rice	HI – cover, bring water and rice to a boil	LO – to maintain Low Boil. Cover and cook until water is absorbed	Same as for standard burners XLO – to hold, cover
Sauces Tomato base	MED HI – cook meat/vegetables, follow recipe	LO – to maintain simmer	XLO – simmer to thicken sauce, uncovered
White cream, béarnaise	MED – melt fat, follow recipe	LO – finish cooking	XLO – to hold, cover
Hollandaise	XLO		XLO – to hold, lowest setting for short period, stir frequently
Soups, stock	HI – cover, bring liquid to a boil	LO to maintain simmer	Simmer XLO – to hold, cover
Vegetables Fresh	HI – cover, bring water and vegetables to a boil	LO to MED – cook 10 minutes, or until tender	Same as for standard burners XLO – to hold, cover
Frozen	HI – cover, bring water and vegetables to a boil	LO to MED – cook according to package directions	Same as for standard burners
Deep frying	HI – heat oil	MED to MED HI – maintain frying temperature	Same as for standard burners
In pouch	HI – bring water and pouch to a boil	LO to MED – cook according to package directions	Same as for standard burners
Sauté	HI – heat oil or melt butter, add vegetables	LO to MED – cook to desired doneness	Same as for standard burners
Stir fry	HI – heat oil, add vegetables	HI to MED HI – finish cooking	Same as for standard burners

# Electric griddle

## Description

---

### ⚠ CAUTION

---

The griddle element is hot after use. Allow sufficient time for griddle components to cool before cleaning.

---

### ⚠ WARNING

---

To avoid risk of injury, never operate the griddle without the griddle plate installed. Never use the griddle in a manner that is not prescribed by the Use and Care Guide.

---

**NOTE:** Not available on all models.

Griddle widths vary.

A maple chopping block and stainless steel cover are available as accessories and are purchased separately. The maple chopping block and stainless steel cover must be removed before turning the griddle on.

The griddle plate must always be in place when the griddle is turned on.

The griddle is electronically controlled with temperatures marked on the knob from 150° – 500°F (66° – 260°C). There are no fixed settings on the knob.

The 24" griddle models have two heating elements that can be regulated separately; one element for the left side of the griddle and another for the right side. This allows you to cook food with different temperature requirements at the same time.

## Preparing the griddle

### To prepare the griddle

1. The griddle plate should be washed with warm soapy water then rinsed with clear water prior to use.
2. Check the griddle plate adjustment by pouring two tablespoons of water on the back of the griddle plate.
  - The water should slowly roll into the grease tray.
3. If water does not flow to the front of the griddle, move the griddle plate to the side.

4. Adjust the two screws under the back of the plate. Start with one half turn counterclockwise of the screws (below).

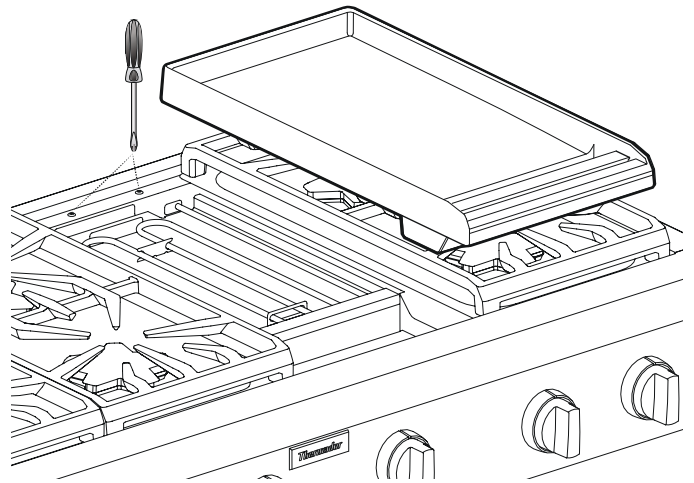

5. Further adjustment should be made by one-quarter turn until water slowly flows into the grease tray.

The griddle may be used without any butter, margarine or oil. However, a very small amount may be used to flavor foods.

**DO NOT** use metal utensils on the griddle surface. Care should be taken that the surface is not gouged when utensils are used. **DO NOT** cut directly on the griddle plate.

**NOTICE:** Performance may vary if there is an excessive amount of airflow in the vicinity of the appliance. The excessive airflow could be from an air-conditioning register or ceiling fan blowing at the rangetop. This could create longer than normal heat-up time, or it could cause the temperature to be higher or lower than the knob setting.

**NOTE:** Having a properly installed ventilation hood is not considered a source of excessive airflow.

## Cooking on the griddle

### To cook on the griddle

1. Press and turn the knob clockwise to the appropriate cooking temperature to preheat the griddle.
2. Preheat the griddle.
3. Add butter, margarine, oil or shortening if desired.

Use the lowest cooking temperature possible. Recipes may need to be modified as the non-stick coating browns and sears at lower temperatures.



## 12" griddle cooking recommendations

Food *	Setting
Eggs	325° – 350°F
Bacon, breakfast sausage	450° – 475°F
Toasted sandwiches	375° – 400°F
Boneless chicken breasts	425° – 450°F
Boneless pork chops, 1" (25.4 mm)	425° – 450°F
Steaks, 1" (25.4 mm) thick	450° – 475°F
Ground beef patties, 6 oz.	450° – 475°F
Ground turkey patties, 6 oz.	450° – 475°F
Hot dogs	350° – 375°F
Ham slices, ½" (12.7 mm) thick	350° – 375°F
Pancakes, French toast	400° – 425°F
Potatoes, hashbrowns	400° – 425°F

\* Level foods to a uniform thickness to ensure even cooking.

## 24" griddle cooking recommendations

Food *	Setting
Eggs	275° – 300°F
Bacon, breakfast sausage	400° – 450°F
Toasted sandwiches	350° – 375°F
Boneless chicken breasts	400° – 425°F
Boneless pork chops, 1" (25.4 mm)	400° – 425°F
Steaks, 1" (25.4 mm)	425° – 450°F
Ground beef patties, 6 oz.	400° – 425°F
Ground turkey patties, 6 oz.	400° – 425°F
Hot dogs	300° – 350°F
Ham slices, ½" (12.7 mm) thick	350° – 375°F
Pancakes, French toast	350° – 375°F
Potatoes, hashbrowns	400° – 425°F

\* Level foods to a uniform thickness to ensure even cooking.

## Griddle grease tray

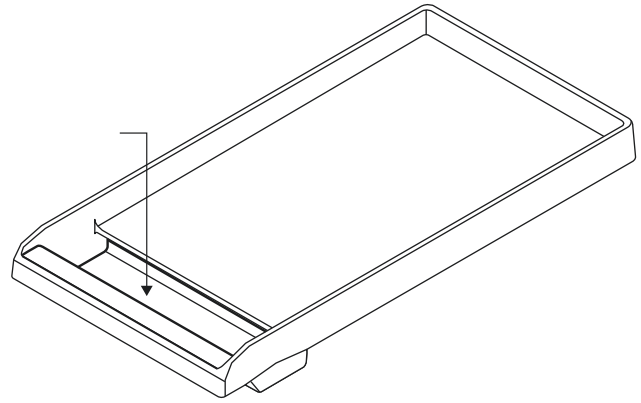

- Clean the tray after every use. When removing the tray, use care when tipping it so that the contents do not spill.
- The grease tray is dishwasher safe.
- After cooling, pour the grease into a grease-resistant container for disposal.

## Care and cleaning the griddle plate

- **NEVER** flood a hot griddle plate with cold water. This can damage the griddle plate.
- **DO NOT** clean the griddle plate in a self-cleaning oven.
- **DO NOT** heat cookware on the griddle surface.
- Care should be taken to avoid scratching or gouging the surface.
  - **DO NOT** cut food directly on the griddle plate.
  - **DO NOT** use metal utensils.
  - Use plastic or wood utensils to avoid scratching the non-stick surface.
- The griddle plate is dishwasher safe, however, hand washing the griddle plate is recommended.

## Seasoning the griddle plate

If the griddle plate seems to lose its non-stick abilities over time, the following instructions should help regain the griddle's non-stick properties. For optimal performance and long life of your griddle plate, follow these simple cleaning and seasoning instructions.

**NOTE:** 24" griddles will not fit in the oven cavity for seasoning. Therefore, care should be taken not to overheat and damage their non-stick coatings while preheating and cooking.

### To prepare the griddle for seasoning

The griddle plate must be clean and all residue removed before the griddle plate is seasoned.

1. Use a mixture of coarse salt and a small amount of white vinegar to buff off any residue from the griddle plate.

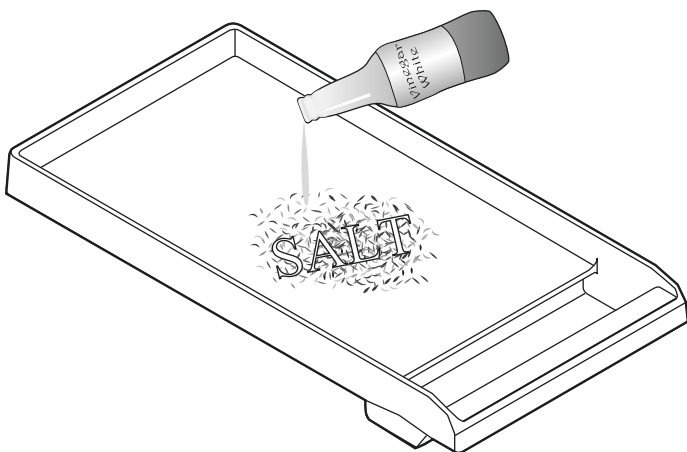

2. Rinse well with clean water.
3. Dry the griddle plate thoroughly.

### To season the griddle

Seasoning is a process by which a layer of animal fat or vegetable oil is applied and baked into the cookware. The seasoning layer provides a non-stick surface for cooking.

1. Use a paper towel to apply a thin, even coating of lard, shortening, or olive oil to the griddle surface.

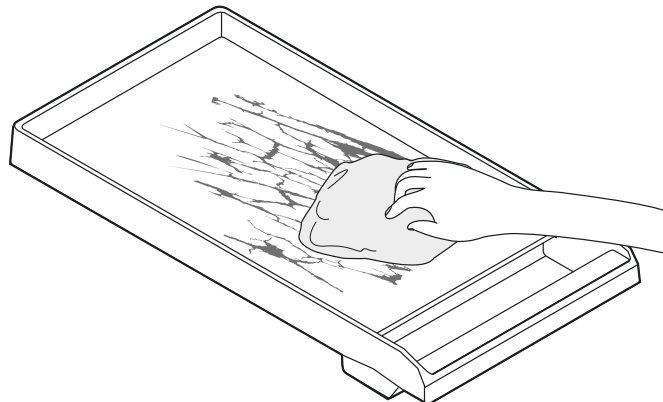

2. Bake the griddle plate in a 350°F oven for 1 hour.
3. Remove the griddle plate from the oven and allow to cool to room temperature.
4. Apply a second layer of fat or oil and bake at 350°F for 1 hour.
5. Repeat process at least one additional time – making 3 coats of oil or fat.

### After seasoning

1. After cooking on your seasoned griddle, allow to cool and wipe clean with a damp cloth. Allow to dry.
2. Add a thin coating of oil or fat before storing your griddle in a cool, dry place.
3. Repeating this process will season the griddle and maintain non-stick properties. Performance will improve over time with more seasoning.
4. To strip the griddle to re-season, a mixture of salt and vinegar should be used to remove any oil layers from the previous seasoning process.

# Electric grill

## Description

### ⚠ WARNING

- To avoid risk of injury, **NEVER** operate grill without the grates or griddle plate accessory installed.
- **NEVER** leave grill unattended while cooking.
- Observe caution with oils and fats. Overheated oils and fats can easily cause fires.
- **DO NOT** use wood chips, lava rocks, or charcoal briquettes. Only use recommended ceramic briquettes (PABRICKBKN).
- **DO NOT** use dishes, pans, pots, or other cookware on the grill.
- **NEVER** use aluminum foil to cover the grates or to line the grill. It can damage the grill and cause a fire hazard if heat is trapped under it.
- Check drip tray before each use. Too much grease in the tray may cause a fire hazard.
- If flames appear, grease should be cleaned from grates, drip tray, briquette basket and other surfaces.
- Grease build up encourages flame and smoke development while cooking.
- Ceramic briquettes must be replaced when they begin to turn black. This means that they are saturated with fat and may smoke heavily during operation or the fat may catch fire.

**NOTE:** Not available on all models.

The built-in grill is made of restaurant-quality cast iron grates. This produces a surface with even heat that is easy to clean.

A non-stick cast iron griddle plate is available as an accessory and may be purchased separately. See the instructions that come with the griddle plate accessory for more details.

## Assembling the grill

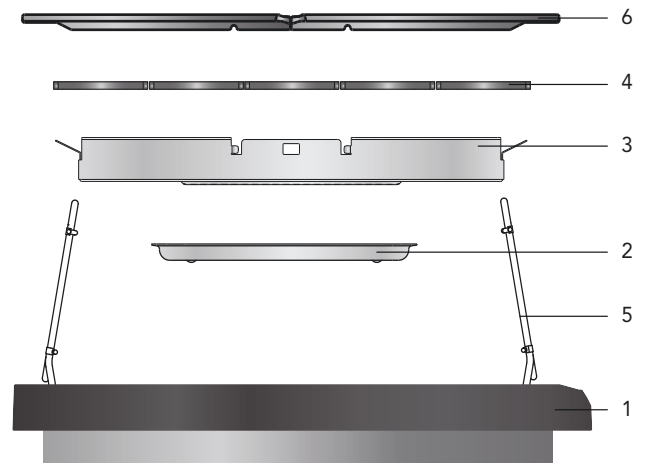

- 1 Grill housing
- 2 Drip tray
- 3 Briquette basket
- 4 Ceramic briquettes
- 5 Heating element (x2)
- 6 Grill grate (x2)

### To assemble the grill

1. Rotate heating elements (5) up and remove the briquette basket (3) stored inside the grill housing (1).
2. Place the drip tray (2) in the bottom of the grill housing (1). (Drip tray is packaged in the large cardboard box that was on top of the appliance.) Align the embosses of the drip tray (2) with the depressions on the bottom of the grill housing (1).
3. Place the briquette basket (3) in the grill housing (1).
4. Arrange the ceramic briquettes (4) on the briquette basket (3), in a single layer. The ceramic briquettes should not contact the heating elements.

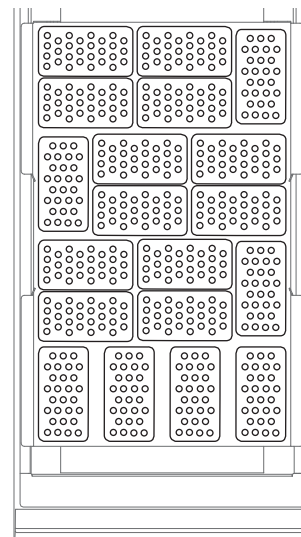

5. Fold both grill heating elements (5) down. The grill heating elements must lie flat. Supports should rest inside of side notches.
6. Install the grill grates (6). Ensure grates are seated level inside the grill housing (1).

## Operating the grill

---

### ▲ WARNING

---

#### TO AVOID RISK OF BURNS:

- Use proper utensils with long handles that allow the chef plenty of clearance from the heat and potential flare ups.
- **DO NOT** wear loose clothing while cooking.
- Never leave grill unattended while cooking.
- After each use, remove grease buildup from the grill surfaces and the trays below the grill to avoid risk of fire. Ventilation hoods should also be cleaned periodically as needed and as recommended by the Use and Care Guide as well as surrounding surfaces.
- Keep a fire extinguisher nearby and accessible.

---

### ▲ CAUTION

---

Clean the grill after each use. Allow the appliance to cool before cleaning.

---

#### IMPORTANT:

- If flames appear while grilling, turn off heat and remove the food. Use caution to avoid any potential injury while removing food.
- Often, such flames will extinguish themselves within a few minutes once grease drippings have burned up. **DO NOT** leave the grill unattended until all flames are extinguished. If desired, flames can be extinguished by generously shaking baking soda or salt over them to smother the fire.
- If flames appear, ceramic briquettes should be replaced and grease should be cleaned from grates, grease tray, briquette basket, and other surfaces before using the grill again. Built up grease which is allowed to remain encourages flame and smoke development while cooking.
- Moist food should be dried, before placing on grill.
- Marinated food may cause more smoke to be produced!
- During grilling, dripping fat may flare up briefly.

### To operate the grill

1. Start overhead ventilation system 10 minutes prior to grilling to begin air movement.
2. The grill grates should be washed with warm soapy water then rinsed with clear water prior to use.
3. Before turning on, make sure that there are ceramic briquettes in the appliance and both grill grates are correctly fitted.
4. Press and turn the knob to the desired temperature setting.
  - The two grill heating elements can be regulated separately. This allows you to grill food with different temperature requirements at the same time, or you can use one area to grill and the other to keep warm.
5. During the initial use, heat the grill for about 10 minutes to eliminate manufacturing residues and smells.
6. For best results, allow the grill grates to preheat before placing food on them.

### Grilling tips

- The grill should be preheated a minimum of 10 minutes before cooking. Depending on browning preference and the types of food being prepared, as much as 15 minutes of preheat time may be required.
- Soak wooden skewers in water a minimum 20 minutes before placing on the grill.
- Prior to grilling, you can coat the food with heat-resistant oil (e.g. peanut oil) or marinate it. Make sure not to use too much oil/marinade, as otherwise it may catch fire and generate thick smoke.
- Lay the food directly on the grill grates. **DO NOT** use aluminum foil or grill trays.
- Cured meat, such as ham or smoked pork chops, is not suitable for grilling. Unhealthy chemical compounds may form.
- To prevent flare-ups, remove excess fat from foods prior to grilling.
- **DO NOT** use cleaners on the heating elements. Allow grease to burn off the heating elements.
- To soak up fat on the grill plate, sprinkle coarse salt onto the grilling surface after use.

## Grill cooking recommendations

### IMPORTANT:

- **GRILL SHOULD NOT BE OPERATED WITHOUT PROPER VENTILATION.**
- Foods with excessive fat or grease should not be prepared on an indoor grill. Grilling foods with high fat content (certain types of ground beef, sausage, etc) increases the chances of smoke and flames.



















Food*	Setting**	Cook time (minutes)	Notes
<b>Beef</b>			
Hamburgers, ¾" (2 cm) (medium)	High	12 – 14	Ready to turn once juices appear on the surface.
T-Bone steak, 1½" (4 cm) (medium)	High	20 – 22	Remove excess fat.
Ribeye or sirloin, 1" (3 cm) (medium)	High	10 – 12	Remove excess fat.
Kebabs, steak (medium)	High	24 – 28	Turn occasionally.
<b>Pork</b>			
Pork chops, ¾" (2 cm)	High	16 – 20	Remove excess fat.
Sausages or bratwurst	Med high	16 – 20	Pierce before grilling.
Hot dogs	High	6 – 8	Place on grill horizontally.
<b>Poultry</b>			
Legs and thighs	Med high	34 – 38	Turn occasionally, remove excess skin.
Chicken wings, whole	Med high	18 – 22	Turn occasionally.
Chicken breasts, ½" (1 cm), boneless	Med high	20 – 24	Pound to an even thickness before cooking.
Kebabs, chicken	High	30 – 33	Turn occasionally.
<b>Seafood</b>			
Fish steak, 2" (6 cm)	Med high	18 – 20	Brush with oil before grilling.
Fish fillet, ¾" (2 cm)	Med high	16 – 20	Brush with oil before grilling.
Shrimp skewers	Med high	10 – 14	Turn occasionally.
<b>Produce</b>			
Portobello mushrooms	High	8 – 10	Brush with oil.
Bell peppers, quartered	High	8 – 10	Turn occasionally.
Eggplant, sliced, ½" (1 cm)	High	8 – 10	Brush lightly with oil.
Tomatoes, halves	High	8 – 10	Brush with oil.
Pineapple, sliced	High	4 – 6	—
Peaches, halves	High	4 – 6	—
<b>Other</b>			
Hamburger or hot dog buns	Med high	4 – 6	Brush with butter.
Tofu, extra firm, sliced	Med high	8 – 12	Skewer for easier grilling.

\* Level foods to a uniform thickness to ensure even cooking.



\*\* The values in the settings table should only be regarded as guidelines, since more or less heat may be required depending on the type and condition of the food.

# Using the oven

## Symbols and descriptions

Symbol/mode	Definitions and recommendations	Electric main	Gas main	Electric aux.	Gas aux.
 Bake	Cooks with dry, heated air. Variety of foods, such as cakes, cookies, pastries, quick breads, quiche and casseroles.	✓	✓	✓	✓
 Conv bake	Similar to bake, but air is circulated by a fan at the back of the oven. Best for baked goods such as cakes, cornbread, pies, quick breads, tarts, and yeast breads.	✓	✓	✓	✓
 True conv	Cooks with heat from a third element at the back of the oven. The heat is circulated throughout the oven by the convection fan. Well suited for cooking individual serving-sized foods such as cookies and pastries.	✓			
 Broil	Uses intense heat radiated from the upper element. Use for tender cuts of meat (1" or less), poultry, browning bread and casseroles.	✓	✓	✓	✓
 Conv broil	Combines intense heat from upper element with fan circulation. Tender cuts of meat (more than 1"), poultry and fish. Not for browning.	✓		✓	
 Proof	Proof (raises) yeast dough and sourdough.			✓	✓
 Roast	Uses more intense heat from upper element, more browning of exterior. Best suited for meats, poultry, less tender cuts of meats and roasting vegetables.	✓	✓	✓	✓
 Conv roast	Uses lower and more intense heat from upper element than convection bake with air circulated by a fan. Use for tender cuts of meat and poultry and roasting vegetables. Meats are more juicy and moist than results with roast mode.	✓		✓	
 Sabbath	This cooking mode is for assisting the user for compliance to Sabbath principles.	✓	✓	✓	✓
 Keep warm	Maintains a low temperature in order to keep food hot. Best for baked goods such as cakes, cornbread, pies, quick breads, tarts, and yeast breads.			✓	
 Self-clean	The oven reaches a high temperature to burn off food soil.	✓	✓	✓	✓
 Remote start	Allows user to start, pause, and abort oven programs remotely via the Home Connect™ app on a mobile device.	✓	✓		
 Fast preheat	Symbol displayed when fast preheating is activated.	✓		✓	
 Meat probe	Appears when a probe is detected.	✓	✓	✓	✓
 Kitchen timer	The kitchen timer runs independently of the other appliance functions.	✓	✓	✓	✓
 Oven timer	Shows the amount of time that the oven mode will run before turning off automatically.	✓	✓	✓	✓
 End timer	Used when delaying the start of a timed oven mode. Shows the time of day that the oven mode will automatically end.	✓	✓		
 Panel lock	Prevents the oven from being turned on or its settings from being changed accidentally.	✓	✓	✓	✓



Symbol/mode	Definitions and recommendations	Electric main	Gas main	Electric aux.	Gas aux.
 Door locking	Symbol is displayed during and after the self-clean mode when the door is locked.	✓	✓	✓	✓
 Remote service	Symbol is displayed if customer service is connected during remote access.	✓	✓		

## Initial start-up

### Start-up settings

The time of day, language and time display settings may be accessed at any time by pressing **SETTINGS** while the appliance is in Standby mode.

1. Connect the appliance to the power supply.

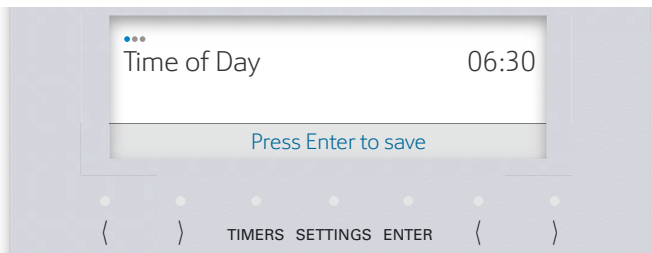

2. Select a setting with the left ( or ).

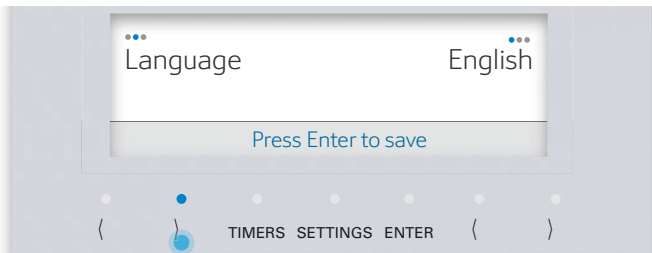

3. Change the setting parameter with the right ( or ).

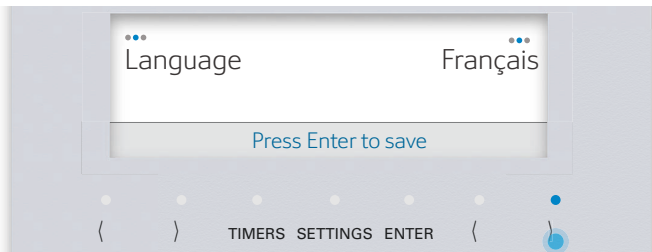

4. Press **ENTER**.

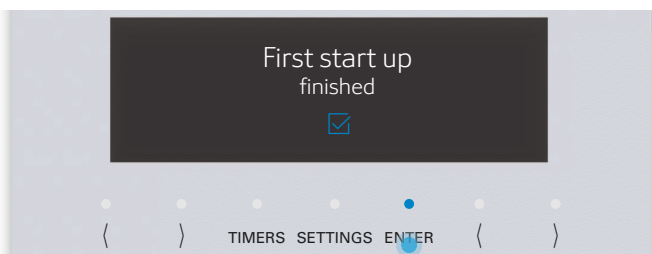

- The screen changes to standby mode.

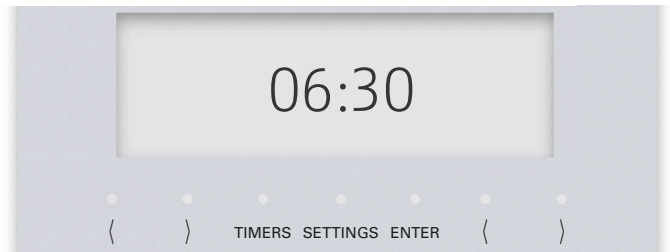

### Available settings

Setting	Option
Time of day	Time in hours and minutes
Language	English, Français, Español
Clock format	12 hr, 24 hr
Clock display	Digital, Analogue
Fast preheat	On, Off
Key press sound	On, Off
Display brightness	1 – 5
Standby mode	On, Off
Convect conversion	On, Off Decreases oven temperature by 25°F (4°C)
Temperature offset	<ul style="list-style-type: none"> <li>• Temp offset: Right oven -35° to +35°F (-20° to +20°C)</li> <li>• Temp offset: Left oven -35° to +35°F (-20° to +20°C)</li> </ul>
Sabbath	On, Off
Home Connect	Set up using the assistant
Factory settings	Restore
Service access	Connect
Customer service	Displays customer service contact information

# Home Connect™ assistant

## About Home Connect

The Home Connect wizard is a part of the initial installation of the appliance on certain models. If the Home Connect is not installed during the first start-up of the appliance it may be accessed in the settings menu.

The Home Connect app must first be successfully installed on a mobile device. See the section "Setting up Home Connect™" on page 45 for full instructions on how to install the Home Connect app.

## Setting up Home Connect

You can start the Home Connect assistant to connect to the Home Connect network and pair your mobile device.

1. Begin from the **STANDBY** mode and select **SETTINGS**.
2. Press the left **<** or **>** to scroll to **HOME CONNECT**.
3. Press **ENTER**.
4. Follow the instructions on the display.

## About data protection

When your appliance is connected for the first time to a WLAN network, which is connected to the Internet, your appliance transmits the following categories of data to the Home Connect server (initial registration):

- Unique appliance identification (consisting of appliance codes as well as the MAC address of the installed Wi-Fi communication module).
- Security certificate of the Wi-Fi communication module (to ensure a secure IT connection).
- The current software and hardware version of your domestic appliance.
- Status of any previous resetting to factory settings.

This initial registration prepares the Home Connect functions for use and is only required when you want to use these Home Connect functions for the first time.

# Setting the oven(s)

## Setting the cooking mode and temperature

1. Place rack in desired rack position and shut the door.
2. Turn the **MODE** knob to **BAKE**, for example.

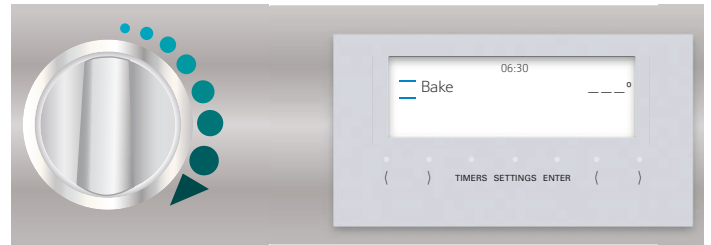

3. Turn the **TEMPERATURE** knob.

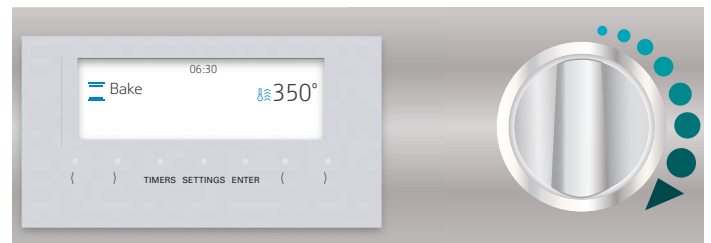

- The temperature gauge will start to move toward the temperature setting. The temperature gauge reflects the temperature setting, not the actual temperature of the oven.
- The needle of the temperature gauge will move to the new selected temperature setting if the temperature setting is increased or decreased. The gauge is for reference only.
- The blue preheating bar moves to the right as the oven heats up.

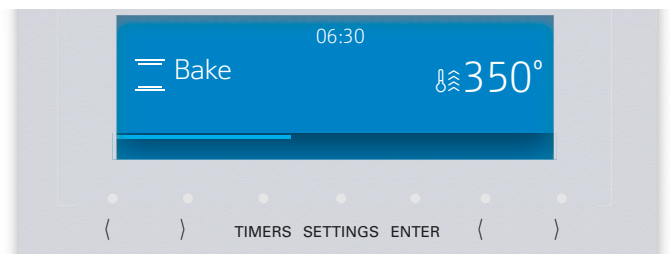

4. After oven has preheated, place food inside.

## Kitchen timer

### About the kitchen timer

- The kitchen timer can be set for up to 24 hours.
- It can be used despite whether the range is in operation and independently of all other functions.
- The appliance does not switch on and off automatically.

### To set the kitchen timer

1. Press **TIMERS**.
2. Press the left < or > and select **KITCHEN TIMER**.
3. Press the right < or > to set your desired time and press **ENTER**.
  - A beep sounds when the timer ends. Press **ENTER** to terminate the beep and timer.

### To change a running timer

1. Press **TIMERS**.
2. Press the right < or > to set your desired time and press **ENTER**.

## |→| Oven timer

### About the oven timer

- After the set time has elapsed, the appliance switches off automatically when the desired cooking time is complete.

### To set the oven timer

1. Turn the **MODE** knob to **BAKE**, for example.
2. Turn the **TEMPERATURE** knob to 350°F, for example.
3. Press **TIMERS**.
4. Press the left < or > and select **OVEN TIMER**.
5. Press the right < or > to set your desired time and press **ENTER**.
  - A beep sounds when the timer ends.

### To change a running timer

1. Press **TIMERS**.
2. Press the right < or > to set your desired time and press **ENTER**.

## →| End timer

### About the end timer

You can delay the cooking time end to a later time. Example: it is 4:00 PM. The dish requires a cooking time of 40 minutes. You want it to be ready at 5:30. Enter the cooking time and delay the cooking time end until 5:30. The appliance starts automatically at 4:50 and switches off at 5:30.

Bear in mind that food which spoils easily should not be left in the oven for too long.

### To set the end timer

1. Set the desired cooking mode and oven temperature.
2. Press **TIMERS**.
3. Press the left < or > and select **OVEN TIMER**.

4. Press the right < or > to set the oven time.
5. Press the left < or > and select **END TIME**.
6. Press the right < or > to set the end time and press **ENTER**.
  - After confirming the end time the waiting time notification appears. After the waiting period the oven starts heating.



## Fast preheat

### About fast preheat

- With fast preheat, you can shorten the preheat time required for some heating modes. Fast preheat is generally recommended for frozen convenience foods, casseroles, or other foods that require longer baking times. This mode is not recommended for baked goods.
- The unit will continue to run the fast preheat indefinitely until the user manually changes it in the settings, or until the unit loses power, in which case fast preheat will need to be reset.
- Fast preheat will also be activated for the secondary oven on 48" models.
- Fast preheat is available for the bake, convection bake, roast, and convection roast modes.
- To achieve an even cooking result, do not place your food into the oven until fast preheating is complete.

### To set the fast preheat

1. Begin from the **STANDBY** mode and select **SETTINGS**.
2. Press the left < or > to scroll to **FAST PREHEAT**.
3. Press the right < or > and select **ON** and then press **ENTER**.

## 🔑 Panel lock

### About the panel lock

- The panel lock is a child safety mechanism to prevent children from accidentally turning on the oven or changing an oven setting.
- Panel lock can only be activated in standby.

### To set the panel lock

1. Press and hold **TIMERS** for four seconds.
  - The panel lock symbol 🔒 and **PANEL LOCKED** will appear in the display.

### To deactivate the panel lock

1. Press and hold the **TIMERS** button for four seconds.

# Convection conversion

## About the convection conversion

- To convert most baked items for use with convection bake and true convection (cookies, cakes, pies, etc.), the oven temperature often needs to be decreased by 25°F. The convection conversion setting reduces the temperature you enter for you automatically.
- The unit will continue to run the convection conversion value indefinitely until the user manually changes it in the settings, or until the unit loses power, in which case convection conversion will need to be reset.
- Convection conversion is available for the convection bake and true convection modes only.
- For meats and poultry, the temperature should not be reduced. The same temperature recommended in recipes and cooking charts for meats and poultry should be used.

## To set the convection conversion

1. Begin from the **STANDBY** mode and select **SETTINGS**.
2. Press the left < or > to scroll to **CONVECT CONVERSION**.
3. Press the right < or > and select **ON**.
4. Press **ENTER**.
5. Turn the mode knob to **CONV BAKE** and the **TEMPERATURE** knob to the recipe temperature.
  - The oven automatically reduces the input temperature by 25°F (10 °C) to the correct temperature.
6. Allow oven to preheat and place food inside.

# Fine tuning the oven

## About offset

The offset feature allows the cook to further fine-tune their cooking parameters to their own personal optimal settings by allowing them to adjust the temperature offset of the oven by +/-35°F in increments of 5°F. This feature is useful if you find that food is consistently either too brown or too light for your tastes.

- The offset feature is available for all modes except self-clean.
- By default, the temperature is set at 0°.
- The unit will continue to run the input offset value indefinitely until the user manually changes it, or until the unit loses power, in which case offset will need to be reset.

## To set offset

1. Begin from the **STANDBY** mode and select **SETTINGS**.
2. Press the left < or > to scroll **TEMP OFFSET: RIGHT/ LEFT OVEN**.
3. Press the right < or > to set the temperature.
4. Press **ENTER**.

## Meat probe

### About the meat probe

The meat probe allows you more control over how your foods are cooked by automatically disabling the specified cooking mode when a dish's desired temperature, defined by the cook, has been reached. The probe expresses the current temperature of the meat as it cooks.

The following are the heating modes that work with the temperature probe:

- Bake
- Convection bake
- Roast
- Convection roast

The temperature probe will not work with the oven timer or with the end timer.

### IMPORTANT:

- To avoid damaging your meat probe, **DO NOT** pull on the cable when trying to remove it from a dish.
- **DO NOT** use tongs or other instruments to pry on the meat probe when removing it or to 'hammer' the meat probe into a food dish.
- To prevent possible burns, wait until the oven has cooled before trying to remove the meat probe from the outlet.
- **DO NOT** store the meat probe inside the oven.

### For best results

- To avoid damaging the meat probe, ensure that the meat is fully defrosted before inserting the meat probe.
- Insert the meat probe until its tip is rested in the center of the thickest, meatiest portion of the meat. Ensure that the meat probe does not touch bone, fat, or gristle.
- For poultry, the meat probe should be inserted into the interior thigh muscle.
- The meat probe should not touch any part of the cooking dish or parts of the oven, as this will affect the accuracy of the results.

## To program the meat probe

1. Insert the plug end into the probe outlet in the oven wall and insert the meat probe end into the meat.

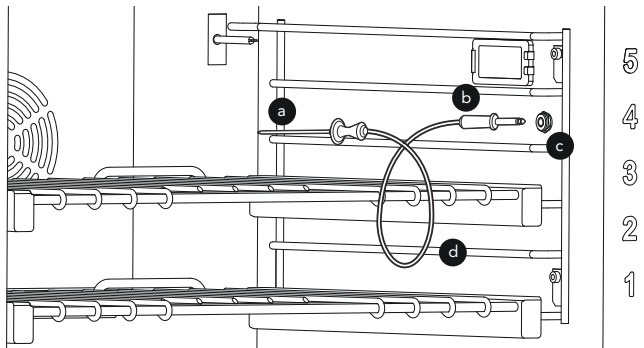

- a. Probe                      b. Plug  
c. Outlet                      d. Cable

2. Close the oven door.
3. Turn the **MODE** and **TEMPERATURE** knobs to your desired settings.
4. Press the right **<** or **>** to the desired internal temperature.

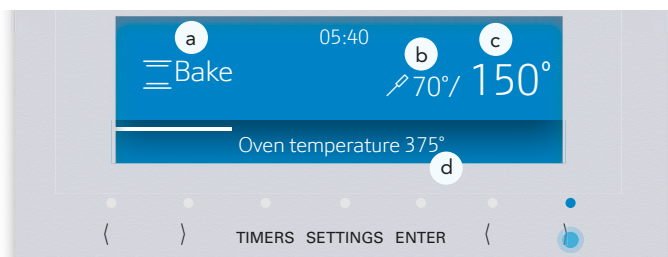

- a. Cooking mode              b. Current probe temp  
c. Set shut-off temp        d. Set oven temp

- The oven display indicates the current temperature of the meat as it cooks.
- The progress bar moves to the right as the internal cooking temperatures increase. When the actual probe temperature reaches the desired set temperature, the cooking mode will be finished and the "end of cook timer" will beep to indicate that the cooking process has concluded.

## Sabbath

The Sabbath mode complies with the standards set forth by Star K. Please know that there are restrictions for the use of cooking appliances on the Sabbath and Holidays. Please note that when the Sabbath and a Holiday coincide, the Sabbath laws prevail. If you are unfamiliar with the laws of keeping food warm on the Sabbath, or cooking on the Holidays, please contact your Rabbi or refer to the Star K website at [www.star-k.org](http://www.star-k.org).

You may operate this appliance on the Jewish Sabbath or the Jewish Holidays if used in accordance with the following knowledge:

### About Sabbath mode – using the rangetop

#### WARNING

When using a blech, use only one STAR<sup>®</sup> burner at the lowest setting. Using multiple STAR burners might cause overheating, combustion issues, or damage to the appliance. **DO NOT** cover vent openings.

- The STAR burners with the XLO<sup>®</sup> feature are controlled electronically. Therefore, when Sabbath mode is initiated, the STAR burners with the XLO feature are deactivated to ensure compliance.
- The standard STAR gas burners without the XLO feature remain fully functional.
- The induction module, griddle, and/or the grill are fully functional during Sabbath mode. However, to ensure compliance, they should not be operated.
- The standard gas STAR burners remain on during a power failure.
- The STAR burners are equipped with a re-ignition feature. The igniter will automatically re-light the STAR burner if the flame is blown out.
- During Yom Tov, a gas flame may not be ignited or turned off. However, the flame may be raised and lowered to adjust the temperature as required for cooking.
- During Sabbath, a gas flame may not be ignited, adjusted, or turned off. You may use a blech to conceal the flame, the lights, and the controls. **DO NOT** cover vent openings.

### About Sabbath mode – using the oven(s)

- The oven maintains a constant temperature between 150°F and 475°F (66°C and 246°C) with the bake mode.
- Cooked dishes are kept warm for a minimum time of 30 minutes and up to a maximum time of 74 hours without needing to switch the appliance on or off.



- All food should be placed in the oven before the Sabbath begins, since none may be placed in the oven during the Sabbath. Please note that easily perishable foodstuffs must not be left in the oven for too long.
- The oven temperature should not be turned on, adjusted, or turned off while observing Sabbath.
- On the Sabbath, in lieu of a blech, the oven controls should be covered. Be careful not to cover vent openings.
- The oven lamp(s) is disabled in Sabbath mode to prevent any action from occurring if the oven door is opened.
- The oven door may only be opened once on the Sabbath to remove all food and then closed.
- The oven door may be opened and closed at any time as often as desired during Holidays.
- The temperature may be adjusted for cooking purposes during Holidays. (There is a delay between the request and implementation).

### Sabbath mode power outage note

If a power outage occurs while the oven is in Sabbath mode, the unit will exit out of Sabbath mode when power is restored. The oven will return to the off state even if it was in the middle of a bake cycle when the power outage occurred.

### To set Sabbath on the main oven

1. Begin from the **STANDBY** mode and select **SETTINGS** on the main oven display.
2. Press the left **<** or **>** to scroll to **SABBATH**.
3. Press the right **<** or **>** and select **ON** and then press **ENTER**.
  - Steps 1 through 3 are only necessary for the first time use of Sabbath or if the appliance's settings are factory reset.
4. Turn the main oven mode knob to **BAKE** and turn the temperature knob to the desired temp.
5. Press **TIMERS** on the main oven display.
6. Press the left **<** or **>** to scroll to **SABBATH TIMER**.

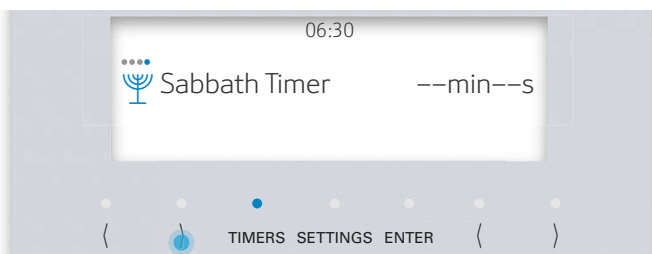

7. Press the right **<** or **>** and enter the **DURATION TIME** in 30 minute increments.
8. Press **ENTER**.

- A delay notification appears.

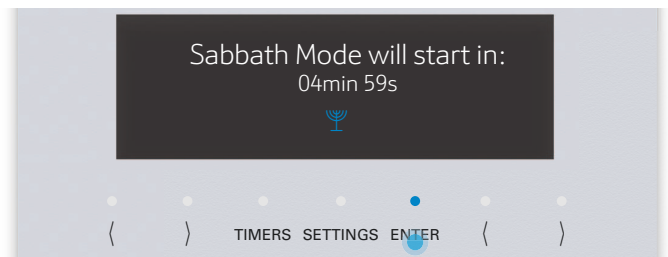

- During this five minute pause, the user can adjust the parameters. After the countdown the oven starts heating and all buttons are disabled.
  - The secondary oven can be turned to any heating mode position to initiate Sabbath during the five minute pause.
9. After the Sabbath timer has completed, turn all knobs to **OFF**.

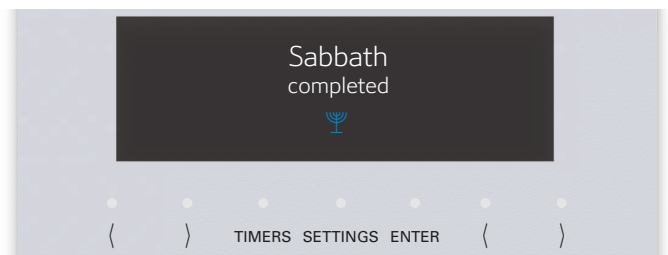

### To cancel Sabbath

1. Turn all knobs to **OFF** to cancel the operation.

### To set Sabbath on the secondary oven

1. Begin from the **STANDBY** mode and select **SETTINGS** on the main oven display.
2. Press the left **<** or **>** to scroll to **SABBATH**.
3. Press the right **<** or **>** and select **ON** and then press **ENTER**.
  - Steps 1 through 3 are only necessary for the first time use of Sabbath or if the appliance's settings are factory reset.
4. Turn the secondary oven mode knob to **BAKE** and turn the temperature knob to the desired temp.
5. Press **TIMERS** on the secondary oven display.
6. Press the left **<** or **>** to scroll to **SABBATH TIMER**.
7. Press the right **<** or **>** and enter the **DURATION TIME** in 30 minute increments.
8. Press **ENTER**.
  - During the five minute pause, the user can adjust the parameters. After the countdown the oven starts heating and all buttons are disabled.

### To cancel Sabbath

1. Turn all knobs to **OFF** to cancel the operation.

# Remote start

## **▲ WARNING**

### REMOTE OPERATION

Some models allow remote operation at any time. Do not store any flammable materials or temperature sensitive items inside, on top or near surface units of the appliance.

## About remote start

If you want to start an oven operation using your mobile device, you must activate remote start.

## Notes

- For some models a permanent remote start can be activated via the Home Connect app. This function allows a remote start of the available operating modes without automatically deactivating remote start.
- Remote start allows you to start, pause, and abort oven programs remotely via the Home Connect™ app on a mobile device.
- The remote start can only be employed if the Home Connect app has been successfully installed on a mobile device. See the section "Setting up Home Connect™" on page 45 for instructions on how to install the Home Connect app.
- Some operating modes can only be started on the oven itself.
- If the appliance is not connected to the home network, the appliance functions in the same way as an oven with no network connection and can still be operated via the appliance.
- The availability of the Home Connect function depends on the availability of Home Connect services in your country. Home Connect services are not available in every country. You can find more information on this at [www.home-connect.com](http://www.home-connect.com)

## Remote start is automatically deactivated in the following situations:

- The oven door is opened 15 minutes after remote start is activated.
- The oven door is opened 15 minutes after the oven operation has ended.
- 24 hours after remote start has been activated.

## IMPORTANT:

- Ensure that you follow the safety instructions in this instruction manual and that you comply with these even when you are away from home and are operating the appliance via the Home Connect app. You must also follow the instructions in the Home Connect app.
- Operating the appliance directly from the appliance always has priority. During this time, it is not possible to operate the appliance using the Home Connect app.
- We are constantly working to improve the Home Connect app, which may lead to differences in the setup steps. Please rely on the instructions in the latest version of the Home Connect app to guide you through the setup process.

## To set remote start

1. Place the food in the oven and then close the door.
2. Turn the mode knob to **REMOTE START**.
  - **DO NOT** rotate the temperature knob to any setting (leave in the off position).

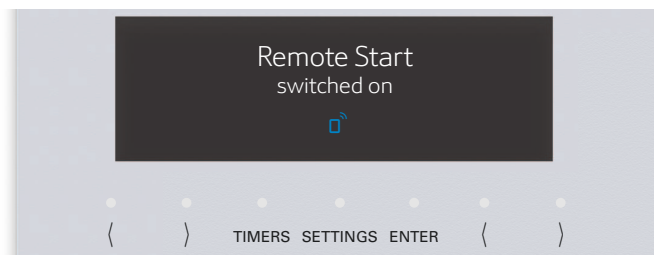

- The display turns to the standby screen and  appears in the display.

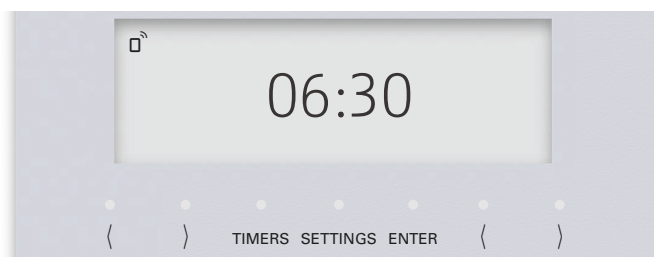

3. Continue with the Home Connect app installed on your mobile device.



# Getting the most out of your appliance

## Oven rack positions

Rack level positions in the oven are numbered on the front frame like an elevator. Number one level is the lowest and number five level is at the top.

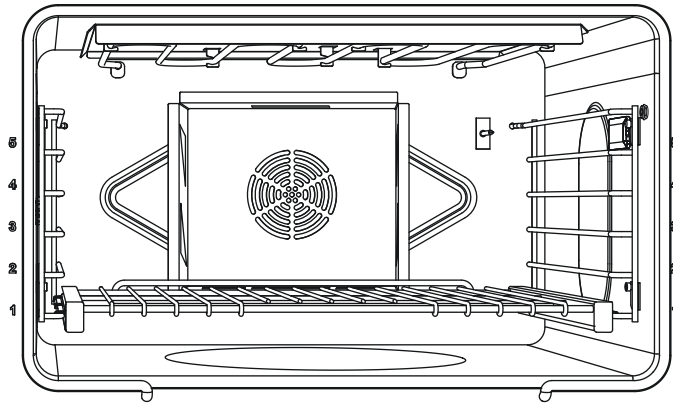

**NOTE:** Rack positions are general recommendations for baking; however, if a recipe calls for a different rack position than those given, then the recipe or package directions should be followed.

## Bake

### About bake

Bake is cooking with dry, heated air. Both the upper and lower elements cycle to maintain the oven temperature. The bake mode can be used to prepare a variety of food items, from pastries to casseroles. Refer to recipe or package directions for oven temperature and baking time.

### Main oven one rack baking

Level	Bake mode
3	-- Best used for most baked items.
2	-- If the item is tall, such as an angel food cake. -- Pies are best baked on rack level 2 to make certain the bottom of the crust is done without over-browning the top. -- When large pieces of meat or poultry are roasted, such as a prime rib of beef or a turkey.

### Main oven two rack baking

Levels	Bake or conv bake mode
2 and 5 dual fuel 2 and 4 gas	-- Casserole dishes

### Secondary oven (48" models)

Level	Bake mode
1	-- Best used for most baked items.

### Main oven three rack baking

If three-rack baking is desired, the Convection Bake mode is best.

## Getting the best results

- Minimize opening the oven door(s).
- Use the rack position recommended by the recipe.
- Use the bakeware recommended in the recipe.
- Store the broiler pan(s) outside the oven. An extra pan without food affects the browning and cooking.
- The type of pan used affects the browning:
  - For tender, golden brown crusts, use light non-stick/anodized or shiny metal pans.
  - For brown crisp crusts, use dark non-stick/anodized or dark, dull metal pans or glass bakeware. These may require lowering the bake temperature 25°F.

### Preheating the oven

- Most cooking times in recipes are designed for a preheated oven and require that the oven already be at a certain temperature before cooking starts. Refer to your recipe for preheating recommendations.
- Preheating time depends on the temperature setting and the number of racks in the oven.

### Bakeware type

- Metal bakeware (with or without a non-stick finish), heat-proof glass, glass-ceramic, pottery, or other utensils are suitable for the oven.
- Suitable cookie sheets have a small lip on one side. Heavy sheets or those with more than one side may affect the baking time.

## Pan placement

- Allow at least 1" (25.4 mm) of space between the pans and the oven walls so heat can circulate around each pan.
- Stagger bakeware so that one is not directly above another. Allow 1½" (38 mm) above and below each pan.

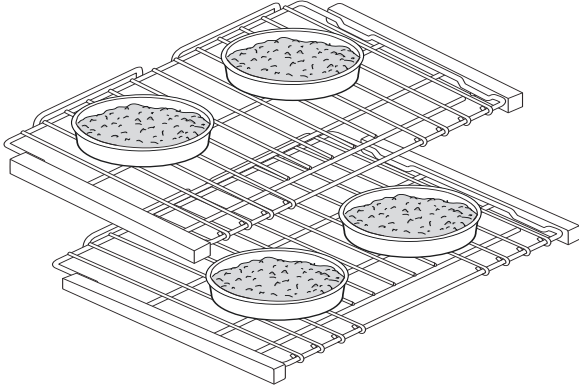

## High altitude baking

When cooking at high altitudes, recipes and cooking times will vary. For accurate information, write the Extension Service, Colorado State University, Fort Collins, Colorado 80521. There may be a cost for the guides. Specify which high altitude food preparation guide you prefer: general information, cakes, cookies breads, etc.

## Condensation

It is normal for a certain amount of moisture to evaporate from the food during any cooking process. The amount depends on the moisture content of the food. The moisture will condense on any surface cooler than the inside of the oven, such as the control panel.

## Broil

### About broil

Before turning on the oven, place the rack in the desired position. After preheating the broiler, center the broil pan under the broil element.

Only the upper element heats in the broil mode. Successful broiling requires constant exposure to high, intense heat.

## Dual fuel main oven broil rack recommendations

Level	Dual fuel broil mode
5	-- Beef steaks, ground meat patties, ham steak and lamb chops 1" (25.4 mm) or less in thickness. Also use when top browning foods.
4	-- Meat 1-1/8" (29 mm) or more in thickness or fish, poultry, pork chops and ham steaks 1" (25.4 mm) or more in thickness.
3	-- Chicken quarters or halves.

## Gas main oven broil rack recommendations

Level	Gas broil mode
4	-- Beef steaks, ground meat patties, ham steak and lamb chops 1" (25.4 mm) or less in thickness.
3	-- Meat 1-1/8" (29 mm) or more in thickness or fish, poultry, pork chops and ham steaks 1" (25.4 mm) or more in thickness. Use this rack when broiling chicken quarters or halves. Also use when top browning foods.

## Secondary oven broil rack recommendations (48" models only)

Levels	Secondary broil mode
3, 4, or 5 – dual fuel 1, 3, or 4 – gas	-- Depending upon the type and thickness of the food.
5 – dual fuel 3 – gas	-- Top browning of foods.

## Getting the best broil results

### Tips:

- Defrost food before broiling.
- Door is to be closed during broiling.
- It is recommended that you preheat the broil element before starting to cook. Preheat for 5 minutes then place food in oven.
- Steaks should be more than 1" (25.4 mm) thick if rare meat is desired. Use convection broil if steaks are over 1½" (38 mm) thick.
- Turn foods over only once, after half the total cooking time. It is not necessary to turn very thin foods (ham slices, fillets of fish, etc.). Liver slices must be turned over regardless of thickness.
- Center foods directly under the broiling element for best browning.

## Utensils

- Your appliance comes with a large two-piece broiler pan. The slotted grid allows drippings to flow into the lower pan, away from the intense heat of the broil element, minimizing spattering, smoking, and the chance of a grease fire. **DO NOT** cover the slotted grid (top) with aluminum foil.
- Use metal or glass-ceramic bakeware when top browning casseroles, main dishes, or bread.
- **DO NOT** use heat-proof glass or pottery. This type of glassware cannot withstand the intense heat of the broil element.

**NOTE:** It is not possible to use the bake mode and broil mode simultaneously. When one mode is on, the other mode cannot be turned on.

## Convection broil

### About convection broil

Convection broil is similar to broil. It combines intense heat from the upper element with heat circulated by a convection fan.

Convection broil mode is well suited for cooking thick, tender cuts of meat, poultry and fish. Convection broil is not recommended for browning breads, casseroles and other foods. Always use convection broil with the door closed.

In addition to the benefits of standard broiling, convection broiling is faster.

### Tips:

- Preheat oven 3-4 minutes. Do not preheat for more than 5 minutes.
- Meat should be at least 1½" thick. Use the broil pan and grid included with your oven.
- Do not cover the broil grid with foil. It is designed to drain fats and oils away from the cooking surface to prevent smoking and spattering.
- Turn meats (other than fish) once during the recommended cook time.

## Convection bake

### About convection bake

Convection bake is similar to bake. Heat comes from the lower heating element. The main difference in convection baking is that the heat is circulated throughout the appliance by the convection fan.

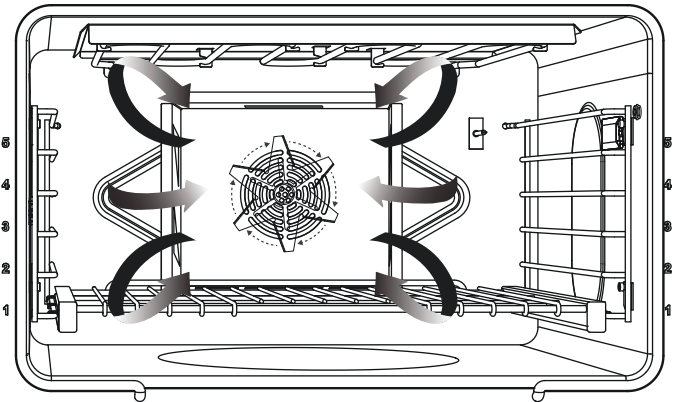

### Tips:

- To convert most recipes for baked items (cookies, cakes, pies, etc.); reduce the oven temperature by 25°F.
- For meats and poultry, the temperature should not be reduced. The same temperature recommended in recipes and cooking charts for meats and poultry should be used.
- Low, shallow bakeware should be used with convection cooking. This allows the heated air to circulate around the food.
- When baking on more than one rack, cookie sheets should not be staggered; round cake pans should be staggered.
- Any food cooked uncovered will brown evenly and form a nice crust. Foods in covered dishes (casseroles, pot roast) or delicate custards do not benefit from convection cooking.
- For small items such as cookies, check to see if they are done one to two minutes before the recipe time. For larger baked items such as cakes, check five to six minutes before the time indicated on the recipe.
- Large meat or poultry items may cook up to 30 minutes less than the suggested time so check them so they will not be over baked.

### One rack convection baking

Level	Conv bake mode
3	-- When baking on one rack, best results are obtained in the bake mode.
2	-- Roasting a turkey or a large piece of meat.

### Two rack convection baking

Levels	Conv bake mode
2 and 4	-- Use for cakes, cookies, biscuits, and other baked goods. Cake pans should be staggered. Cookie sheets should be placed on rack 2 directly under the one on rack 4. -- To bake several casseroles, frozen pies, or cakes. -- These two racks can also be used for a large oven meal.

### Three rack convection baking

Levels	Conv bake mode
1, 3, and 5 Dual Fuel	-- When several sheets of cookies are to be baked. Place the baking sheets directly above each other on the respective racks to allow air to flow around the baking sheets.
Gas see note	-- Gas range rack levels for: Cookies: 2, 3, and 4 Other foods: 1, 3, and 5

### Dehydrating foods with convection bake

Use the convection bake to dry and preserve fruits and vegetables.

#### Tips:

- Drying times vary depending on the moisture and sugar content of the food, the size of the pieces, the amount being dried and the humidity in the air.
- Dry most fruits and vegetables at 150°F (66°C).
- Check food at the minimum drying time.
- It is best to use drying racks (not included) so that air can flow around the food. Do not place food directly on a baking sheet or pan. Food needs to be elevated to ensure even drying.
- Multiple drying racks can be used simultaneously.

- Racks 2 and 4 or 1, 3 and 5 can be used for multiple rack dehydrating. Use rack 3 if only dehydrating one rack.
- Dehydrating meat is not recommended due to food safety concerns.
- Consult a food preservation book, county Cooperative Extension Office or library for additional information.

### Convection bake dehydration recommendations

Food	Preparation	Approx. time (hrs)	Doneness test
Apple, ¼" slices	Dipped in ¼ cup lemon juice and 2 cups water	8 – 15	Slightly pliable
Bananas, ¼" slices	Dipped in ¼ cup lemon juice and 2 cups water	8 – 15	Slightly pliable
Cherries	Wash and towel dry. For fresh cherries, remove pits	7 – 18	Pliable leathery, chewy
Orange peels	Orange part of skin thinly peeled from oranges.	1 – 4	Dry and brittle
Orange slices	¼" slices of orange	9 – 16	Skins are dry and brittle, fruit is slightly moist
Pineapple rings	Towel dried	7 – 12	Soft and pliable
Strawberries	Wash and towel dry. Sliced ½" thick, skin down on rack	9 – 17	Dry and brittle
Peppers	Wash and towel dry. Remove membrane of peppers, 1" coarsely chopped pieces	13 – 17	Leathery with no moisture inside
Mushrooms	Wash and towel dry. Cut thin slices, 1/8" thick	5 – 12	Tough and leathery, dry
Tomatoes	Wash and towel dry. Cut thin slices, 1/8" thick, drain well	5 – 12	Dry, brick red color

# True convection

## About true convection

True convection cooks with heat from a third element behind the back wall of the oven. The heat is circulated throughout the oven by the convection fan.

Dual fuel levels	True conv mode
4 and 5	-- Cookies
2, 3, and 4	-- Cookies
1, 3, and 5	-- Pastries and other baked goods

### Tips:

- Reduce recipe temperature by 25°F.
- Place food in low-sided, uncovered pans such as cookie sheets without sides.
- If baking more than one pan on a rack, allow at least 1" to 1½" of air space around the pan.

# Proof

## About proof

The proof feature maintains the warm, non-drafty environment needed for proofing yeast leavened products.

It is best to start with a cool oven when using the proofing function.

### To set the oven for proof

1. Allow dough to thaw if frozen.
2. Place dough in dish and loosely cover.
3. Use any rack level that accommodates the size of the bowl or pan. Close the door.
4. Turn the mode knob to **PROOF**.
5. Turn the oven temperature knob to 150°F.

Size	Time
Loaf, 1 lb (0.45 kg)	60 – 75 minutes
Rolls, 0.1 lb (0.05 kg)	30 – 45 minutes

The ideal temperature for proofing will be maintained until the mode knob is turned off. Dough has “proofed” when it has doubled in size.

Do not open the oven door unnecessarily. Opening the door will lower the temperature of the air in the oven and lengthen the proofing time. Use the oven light to check the rising of the dough.

Proofing time may be decreased when using the large oven at the same time you are proofing. Check bread product early to avoid over-proofing. If you are using the large oven for extended periods of time we recommend, for optimum results, that you complete the proofing before using the large oven.

# Roast

## About roast

Roast uses both the upper and lower elements to maintain the oven temperature. Roasting uses more intense heat from the upper element than the lower element. This results in more browning of the exterior while the inside remains especially moist. Roast is best suited for large cuts of meat and poultry.

### Tips:

- Use a high-sided broil pan, or cover dish with a lid or foil.
- Add liquids, such as water, juice, wine, bouillon or stock for flavor and moisture.
- Roasting bags are suitable for use in this mode.
- When roasting whole chicken or turkey, tuck wings behind back and loosely tie legs with kitchen string.

### Roasting recommendations

Meat and poultry	Temperature	Level
Beef		
Pot roast, 3 – 4 lbs.	350°F (180°C)	1
Beef brisket	350°F (180°C)	2
Beef chuck	350°F (180°C)	1
Meatloaf	350°F (180°C)	3
Poultry		
Chicken, whole	375°F (190°C)	2
Chicken, pieces	375°F (190°C)	2
Turkey, whole	325°F (165°C)	2
Pork		
Shoulder	325°F (165°C)	1
Smoked ham, half	325°F (165°C)	1

## Convection roast

### About convection roast

Convection roast uses heat from the top and bottom elements as well as heat circulated by the convection fan.

The convection roast mode is well suited for preparing tender cuts of meat and poultry. The benefits of convection roast mode include:

- As much as 25% faster cooking than non-convection modes.
- Rich, golden browning.

### Tips:

- Use the same temperature as indicated in the recipe.
- Check doneness early, since roasting time may decrease.
- Do not cover meat or use cooking bags.
- Use the broil pan and grid provided with the oven for roasting. A shallow, uncovered pan can also be used.
- Use a meat thermometer to determine the internal temperature of the meat.
- If the meat is browned to your liking, but is not yet done, a small strip of foil can be placed over the meat to prevent over-browning.
- Let meat stand covered with foil 10-15 minutes after removing it from the oven.

## Keep warm

### About keep warm

- The keep warm mode will keep hot, cooked foods at serving temperature. **ALWAYS** start with hot food. **DO NOT** use this mode to heat cold food other than for crisping crackers, chips and dry cereal.
- Serving dishes, plates and cups may be kept warm with this mode.
- Warm mode temperatures range from 140°–150°F / 60°–66°C. Food should be at serving temperature (above 140°F / 60°C) before being placed in the oven.

- Food may be kept hot in its cooking container or transferred to a heat-safe serving dish.
- Aluminum foil may be used to cover food. Use only heat-safe dishes.
- **DO NOT** open the oven door unnecessarily. Opening the door will reduce the temperature of the oven.
- When keeping cooked food warm, allow time for the oven to preheat before placing the item in the oven.

### To set the warm mode

1. Turn the mode knob to **WARM**.
2. Turn the oven temperature knob to 150°F.
3. Place warmed dish in the oven and close the door.

### Minimum internal cooking temperatures

The minimum internal temperatures that foods must reach to be considered safe to eat, as determined by the U. S Department of Agriculture Food Safety and Inspection Service, are as follows:

Egg dishes, casseroles	160°F (72°C)
Leftovers	165°F (74°C)
Ground beef, veal, lamb, or pork	160°F (72°C)
Beef, veal, lamb roasts, steaks, or chops	
Medium rare	145°F (63°C)
Medium	160°F (71°C)
Well done	170°F (77°C)
Pork roasts, steaks, or chops	
Medium	160°F (72°C)
Well done	170°F (77°C)
Ham	
Cook before eating	160°F (72°C)
Fully cooked, to reheat	140°F (60°C)
Poultry	
Ground chicken, turkey	165°F (74°C)
Whole chicken, turkey	180°F (82°C)
Breasts, roasts	170°F (77°C)
Thighs and wings	180°F (82°C)
Stuffing (cooked alone or in bird)	165°F (74°C)

# Setting up Home Connect™

With Home Connect™, the appliance is Wi-Fi capable and can be remotely controlled using a mobile device (e.g. tablet or smartphone). The Home Connect app offers additional functions which are a perfect complement to the networked appliance.

Home Connect does not work over Wi-Fi networks that require browser registration, i.e. a user name and password entered via a web browser.

You should have a stable wireless network with good reception and access to the internet.

If the appliance is not connected to the WLAN network (home network), it functions in the same way as a typical appliance with no network connection and can be operated as usual.

**NOTE:** Please ensure that you follow the safety instructions given at the beginning of this instruction manual and that these are also observed when operating the appliance via the Home Connect app and when away from home. Please also follow the instructions in the Home Connect app.

**NOTE:** Operation on the appliance itself always takes priority, and during this time it is not possible to operate the appliance using the Home Connect app.

## Setup

To implement settings via Home Connect you must have installed the Home Connect app on a mobile device (e.g. tablet or smartphone). Please observe the supplied Home Connect documents that came with your appliance with regard to this feature.

Follow the steps specified by the app to implement the settings.

### What do you need to connect your appliance to Home Connect™?

1. Your appliance must be installed properly.
2. A smartphone or tablet equipped with the latest version of iOS or Android operating system.
3. Your home appliance within the Wi-Fi signal of your home network.
4. The name of your Wi-Fi network (SSID) and its password (key).

### IMPORTANT INFORMATION ABOUT DATA SECURITY:

The transfer of data is always encrypted. Home Connect meets the highest security standards, which are continuously reviewed. For further information visit [www.home-connect.com](http://www.home-connect.com).

### Information:

We are constantly working to improve the Home Connect app, which may lead to differences in the setup steps. Please rely on the instructions in the latest version of the Home Connect app to guide you through the setup process.

### Step 1: Download the Home Connect app and create a user account

1. Open the App Store (Apple® devices) or Google Play™ store (Android™ devices) on your smartphone or tablet.
2. Search for the **HOME CONNECT** app in the store's search and install it.
3. Open the app and register to create a Home Connect account.
4. Write down your Home Connect account credentials (user account and password). You will need them later.

Save your Home Connect login details here:

Network name  
(SSID):.....

Password  
(Key):.....

The app will guide you through the steps of adding your appliance to Home Connect.

### Step 2: Connect your appliance to your home network

1. Your appliance must be installed properly.
2. Open your Home Connect app to add an appliance.
3. Please follow the directions in the app and refer to this guide only when prompted by the app.

## Step 2.1: Connect your appliance to your home network with WPS

Please enter step 2.1 only when prompted to by the app. The following steps describe operations at the appliance itself.

1. Press **SETTINGS** and select **HOME CONNECT**.
2. Press **ENTER**.
  - A request to press the WPS button on the router within 2 minutes appears in the display.
3. Press the **WPS button** on your router.
  - Please consult your router's manual to locate the WPS button.
  - The app will get notified once your appliance has been successfully connected to your Wi-Fi network.
4. Press **ENTER**.
  - A message will appear in the display informing the user if the network was connected successfully.
5. Press **START PAIRING** in the Home Connect app.
6. Follow the directions in the app.

### Information:

If the connection could not be established within 5 minutes, make sure your appliance is within the range of your Wi-Fi network.

## Step 2.2: Connect your appliance to your home network step-by-step

Please enter step 2.2 only when prompted by the app. The following steps describe operations at the appliance itself.

1. Select **SETTINGS** and scroll to **HOME CONNECT**.
2. Press **ENTER**.
  - A request to press the WPS button on the router within 2 minutes appears in the display.
3. Press **ENTER**.
4. Select **CONNECT MANUALLY**.
  - Have your mobile device ready for manual connection to network.
5. Press **CONTINUE**.
  - The appliance will open a temporary Wi-Fi network called "HomeConnect" with the password "HomeConnect" for 2 minutes.

- The app provides your home Wi-Fi network name (SSID) and its password via this temporary Wi-Fi network to the appliance enabling the appliance to connect to your home Wi-Fi network.

6. Follow the directions in the app.

## Step 3: Connect your appliance to the Home Connect™ app

Please enter step 3 only when prompted by the app. The following steps describe operations at the appliance itself.

1. Launch the app on your mobile device and follow the instructions in the app.
2. The login process is complete once **PAIRING SUCCESSFUL** is shown on the oven display.
3. Follow the directions in the app.

You have successfully connected your appliance. You can now benefit from all the advantages of the Home Connect™ app!

### Information:

If the connection could not be established within 5 minutes, make sure your appliance is within the range of your Wi-Fi network.

## Software update

Using the software update function, your appliance's software can be updated (e.g. for the purpose of optimization, troubleshooting or security updates). To do this, you need to be a registered Home Connect™ user, have installed the app on your mobile device, and be connected to the Home Connect™ server.

As soon as a software update is available, you will be informed through the Home Connect™ app and will be able to start the software update via the app.

Once the update has been successfully downloaded, you can start installing it via the Home Connect™ app if you are on your local area network.

The Home Connect™ app will inform you once installation is complete.

### Notes:

- You can continue to use your appliance as normal while updates are downloading.
- Depending on your personal settings in the app, software updates can also be set to download automatically.
- We recommend that you install security updates as soon as possible.



# Care and maintenance

---

## ▲ WARNING

---

- Children should not be left alone or unattended in an area where appliances are in use.
  - During the self-clean cycle, exterior surfaces may become hotter than usual. Parts of the appliance may become potentially harmful to children, and to persons who lack adult knowledge of appliances and lack adult reactions to potentially harmful conditions. Keep these individuals away during self-clean and while the appliance is in use.
  - The elimination of soil during self-cleaning may facilitate the emission of small amounts of chemicals or other substances that may be harmful upon sufficient exposure. To minimize exposure to these substances, provide good ventilation with an open window, or use a ventilation fan or hood.
  - For the self-cleaning cycle of your range, remove small animals and birds from the kitchen and surrounding areas. Open a nearby window for additional ventilation. During self-clean, fumes are released that may be harmful.
- 

## Brand names

- The use of brand names is intended only to indicate a type of cleaner. This does not constitute an endorsement.
- The omission of any brand name cleaner does not imply its adequacy or inadequacy.
- Many products are regional in distribution and can be found in local markets.
- It is imperative that all cleaning products be used in strict accordance with the instructions on its package.

## About self-clean

- The self-cleaning mode of your new range features pyrolytic self-cleaning. When set to the self-clean mode, the oven reaches a high temperature, approximately 850°F (454°C), that burns off the food soil.
- When the oven is set for self clean, the standard rangetop burners and the electric griddle and grill may be used. The burners having the ExtraLow® feature cannot be used.
- It is common to see smoke and/or flames during the clean cycle, depending on the content and amount of soil remaining in the oven. If a flame persists, turn off the oven and allow it to cool before opening the door to wipe up the excessive food soil.

- At the end of the clean cycle, some gray ash or burned residue may remain inside the oven. This is a mineral deposit that does not burn or melt. The amount of ash depends on how heavily soiled the oven was before it was cleaned. When the oven is cold, it is easily removed using a damp paper towel, sponge, or cloth.

## Before self-cleaning the oven

**DO NOT USE OVEN CLEANERS** – No commercial oven cleaner or oven liner protective coating of any kind should be used in or around any part of the oven.

To reduce flare ups and excess smoke wipe out puddles of grease and any loose soil that can be easily removed. Remove any soil that is outside the door seal area. This appliance is designed to clean the oven interior and the portion of the door that is inside the oven. The outer edges of the door and the frame surrounding the front of the oven are not in the cleaning zone. Wipe this area clean.

## BEFORE SETTING THE OVEN TO SELF-CLEAN

- Remove all utensils.
- Remove racks and rack guides.
- Clean the oven front frame and outer door edges.
- Wipe up large spillovers and grease.
- Be sure the light bulbs and glass covers are in place.
- Turn on the ventilator hood above the range and leave it on until the oven has completed the self-clean cycle.

## Self-clean

### Self-cleaning (select models)

#### To set self-clean on 30" dual fuel Harmony series models

1. Remove all utensils, racks, and rack guides. Ensure the oven door is shut.
2. Turn the mode knob to **SELF CLEAN**.
3. Turn the temperature knob to **CLEAN**.
  - Self-clean duration is 2 hours.

#### To set self-clean on dual fuel models with a display

1. Remove all utensils, racks, and rack guides. Ensure the oven door is shut.
2. Turn the mode knob to **SELF CLEAN** and the temperature knob to **CLEAN**.

- Press the right  $\rangle$  to set the desired clean level and press **ENTER**.

Soil level	Duration (excluding cool off)
Low	1 ½ hours
High	3 hours

- After the information text, press **ENTER**.



**NOTE:** The door closing process takes approximately 20 seconds to complete, at which time the door becomes locked. Check to make certain the door is locked.

#### At the end of the clean cycle

#### **▲ CAUTION**

The interior of the oven will still be at baking temperatures when the automatic lock cycles to its open position and the oven door can be opened.

The door latch will open automatically when the oven is below 500°F (260°C) and the automatic Door Lock completes its 20 second cycle to the open position.

- Turn the mode knob to **OFF**.
- Turn the temperature knob to **OFF**.

#### To set end time of self-clean

- Remove all utensils, racks, and rack guides. Ensure the oven door is shut.
- Turn the mode knob to **SELF CLEAN**.
- Press the right  $\langle$  or  $\rangle$  to set the desired clean level and press **ENTER**.
- Press **TIMERS**, press the left  $\langle$  or  $\rangle$ , and select **END TIMER**.
- Press the right  $\langle$  or  $\rangle$  to set the **END TIMER**, and press **ENTER**.
- After the information text, press **ENTER**.

#### **NOTES:**

- After self-clean completes its cycle, the self-clean function will be prevented from running again for a period of 24 hours.
- If the user tries to enable a self-clean function in an oven where the self-clean function has been restricted, the oven lights will blink on and off in 2-second intervals to indicate to the user that the function is not available. User must turn the knobs to **OFF** to cease the blinking lights.

## Appliance cleaning tips

#### **▲ CAUTION**

Avoid cleaning any part of the range while it is hot.

- The porcelain enamel finish is acid resistant, but not acid proof. Acidic foods, such as citrus juices, tomatoes, rhubarb, vinegar, alcohol or milk, should be wiped up and not allowed to bake onto the porcelain during the next use.
- The heating elements in the oven do not require cleaning. The elements burn themselves clean when the oven is in use.

#### When cleaning this appliance

- Use the mildest cleaning procedure that will do the job efficiently and effectively. Some cleaners of the same type are harsher than others. Try on a small inconspicuous area first.
- Always rub metal finishes in the direction of the polish lines for maximum effectiveness and to avoid marring the surface.
- Use only clean soft cloths, sponges, paper towels, fibrous brushes, plastic, non-metal or steel wool soap pads for cleaning and scouring, as recommended on the chart.
- Most exterior parts of this appliance can be cleaned with hot sudsy water (except the various items specifically identified otherwise). When rinsing is required, rinse thoroughly.
- Always wipe dry immediately to avoid water marks.
- DO NOT USE CHLORINE BASED CLEANERS.**

## Cleaning recommendations

Part/material	Cleaning notes
Burner base / brass Burner cap / cast iron	<ul style="list-style-type: none"> <li>• A stiff nylon bristle tooth brush can be used to clean port openings.</li> <li>• After cleaning, make sure that the burner cap is correctly seated on the burner base.</li> <li>• <b>DO NOT</b> scratch or gouge the port openings of burner cap.</li> <li>• Suggested cleaners; rinse and dry immediately:               <ul style="list-style-type: none"> <li>-- Hot water and detergent</li> <li>-- Bon-ami<sup>®</sup></li> <li>-- Barkeepers Friend<sup>®</sup></li> <li>-- Wright's<sup>®</sup> All Purpose Brass Polish</li> <li>-- Kleen King<sup>®</sup></li> </ul> </li> </ul>
Bezels and control knobs / chrome, metal	<ul style="list-style-type: none"> <li>• <b>DO NOT</b> soak knobs.</li> <li>• <b>DO NOT</b> force knobs onto wrong valve shaft.</li> <li>• Suggested cleaners; rinse and dry immediately:               <ul style="list-style-type: none"> <li>-- Hot water and detergent</li> </ul> </li> </ul>
Broil pan / porcelain enamel	<ul style="list-style-type: none"> <li>• To loosen cooked on food, squirt with liquid detergent and cover with wet paper towels. Allow to stand.</li> <li>• Suggested cleaners; rinse and dry immediately:               <ul style="list-style-type: none"> <li>-- Hot water and detergent</li> <li>-- Vinegar and water</li> <li>-- Dishwasher safe</li> <li>-- Bar Keeper's Friend<sup>®</sup></li> <li>-- Soft Scrub<sup>®</sup></li> <li>-- Bon-ami<sup>®</sup></li> <li>-- Soap-filled fiber or steel wool pads</li> </ul> </li> </ul>
Ceramic briquettes, briquette basket, and grill drip tray	<ul style="list-style-type: none"> <li>• Suggested cleaning for ceramic briquettes;               <ol style="list-style-type: none"> <li>1) Gently place grease-saturated ceramic briquettes in a 6 quart or larger pot.</li> <li>2) Fill the pot with clean water so that all ceramic briquettes are covered at least ½" deep.</li> <li>3) Bring the water to a steady boil. Once reaching a steady boil, continue to boil for 10 minutes.</li> <li>4) Remove heat and allow ceramic briquettes to cool to a safe temperature.</li> <li>5) Pour water off of ceramic briquettes and pat them dry on old towels or paper towels.</li> <li>6) Allow ceramic briquettes to air dry for at least two hours. Some visible grease stains may remain on briquettes after cleaning.</li> <li>7) Reassemble clean, dry briquettes back into the grill before using the grill again.</li> </ol> </li> <li>• New ceramic briquettes can be purchased from the Thermador eShop (order number PABRICKBKN). See the back cover for support information.</li> <li>▲ <b>CAUTION:</b>                Ceramic briquettes must be replaced when they begin to turn black. This means that they are saturated with fat and may smoke heavily during operation or the fat may catch fire.</li> <li>• Suggested cleaners for basket and drip tray; rinse and dry immediately:               <ul style="list-style-type: none"> <li>-- Hot water and detergent</li> <li>-- Dishwasher safe</li> </ul> </li> </ul>
Door(s) / stainless steel	<ul style="list-style-type: none"> <li>• Use care to keep cleaners and water away from the door vents. If water or cleaners spill into the vents, water may streak the glass inside.</li> </ul>

Part/material	Cleaning notes
Exterior finish / stainless steel	<ul style="list-style-type: none"> <li>• Stainless steel resists most food stains and pit marks providing the surface is kept clean and protected. Never allow food stains or salt to remain on stainless steel for any length of time.</li> <li>• Wipe off any smoke residue that remains on the front frame with Fantastik® or Bar Keeper's Friend® cleaners. If stain remains, use a mild liquid cleanser. The amount of smoke stain is directly related to the amount of food soil left in the oven at the time of self-cleaning. Clean the oven often.</li> <li>• Rub lightly in the direction of polish lines.</li> <li>• Chlorine or chlorine compounds in some cleaners are corrosive to stainless steel. Check ingredients on label.</li> <li>• Suggested cleaners; rinse and dry immediately: <ul style="list-style-type: none"> <li>-- Hot water and detergent</li> <li>-- Fantastik®</li> <li>-- Siege® Stainless Steel and Aluminum Cleaner</li> <li>-- Kleen King® Stainless Steel Liquid Cleaner</li> <li>-- Cleaner polish: Stainless Steel Magic® to protect the finish from staining and pitting; enhances appearance.</li> <li>-- Thermador Stainless Steel Conditioner (00576697)</li> <li>-- For hard water spots use household vinegar.</li> </ul> </li> <li>• For heat discoloration; rinse and dry immediately: <ul style="list-style-type: none"> <li>-- Barkeepers Friend®</li> <li>-- Wright's® All Purpose Brass Polish</li> </ul> </li> </ul>
Grates / porcelain enamel on cast iron	<ul style="list-style-type: none"> <li>• The grates are heavy; use care when lifting. Place on a protected surface. <b>DO NOT</b> clean grates in a self-cleaning oven.</li> <li>• The rough texture of the grate can sometimes remove aluminum deposits from the bottom of pans and fill in areas between the high spots on the surface of the grate. Use special care when cooking with copper and aluminum pots and pans as this type of cookware can sometimes leave metal deposits on the grates.</li> <li>• Blisters/ crazing/ chips are common due to the extreme temperatures on grate fingers and rapid temperature changes.</li> <li>• Acidic and sugar-laden spills deteriorate the enamel. Remove soil immediately once the grate has cooled.</li> <li>• Abrasive cleaners, used too vigorously or too often can eventually mar the enamel.</li> <li>• Suggested cleaners; rinse and dry immediately: <ul style="list-style-type: none"> <li>-- Hot water and detergent</li> <li>-- Fantastik®</li> <li>-- Bon-ami®</li> <li>-- Soft Scrub®</li> </ul> </li> <li>• Stubborn stains; rinse and dry immediately: <ul style="list-style-type: none"> <li>-- Soap-filled steel wool pad</li> <li>-- Lestoil®</li> <li>-- Other degreaser</li> </ul> </li> <li>• Metal deposits: <ul style="list-style-type: none"> <li>-- Scotch Brite™ scrub sponge</li> <li>-- Course steel wool pad</li> </ul> </li> </ul>

Part/material	Cleaning notes
Griddle / aluminum with non-stick coating	<ul style="list-style-type: none"> <li>• <b>NEVER</b> flood a hot griddle with cold water. This can warp or crack the aluminum plate.</li> <li>• <b>DO NOT</b> clean any part of the griddle in a self-cleaning oven.</li> <li>• Wipe griddle surface with warm soapy water then rinse with warm water. Wipe dry with a soft cloth.</li> <li>• If food particles stick to the griddle plate, remove with a mild abrasive cleaner such as Soft Scrub®.</li> <li>• Suggested cleaners; rinse and dry immediately: <ul style="list-style-type: none"> <li>-- Hot water and detergent</li> <li>-- Dishwasher safe</li> <li>-- Soft Scrub®</li> </ul> </li> </ul>
Griddle grease tray	<ul style="list-style-type: none"> <li>• Remove tray after grease has cooled. Be careful not to fill it so full that tipping to remove it spills the grease. Discard grease into a grease resistant container for disposal.</li> <li>• Clean the grease tray after each use.</li> <li>• Suggested cleaners; rinse and dry immediately: <ul style="list-style-type: none"> <li>-- Hot water and detergent</li> <li>-- Dishwasher safe</li> <li>-- Soft Scrub®</li> </ul> </li> </ul>
Grill grates / porcelain enamel on cast iron	<ul style="list-style-type: none"> <li>• Clean the grates after each use.</li> <li>• Place the grill grate into a sink and pour boiling hot water over the grate. Lay a dish towel on top of the grate and pour more hot water over the towel. Allow the water to soak into the residue. Scrape away debris with a soap-filled scouring pad.</li> <li>• Stubborn soil: Soft Scrub®.</li> <li>• Suggested cleaners; rinse and dry immediately: <ul style="list-style-type: none"> <li>-- Hot water and detergent</li> <li>-- Dishwasher safe</li> <li>-- Soft Scrub®</li> <li>-- Soft brass wire brush for stubborn residues. Hard steel wire brushes could scratch the porcelain grate coating and cause premature oxidation of the grate.</li> </ul> </li> <li>• Stubborn stains; rinse and dry immediately: <ul style="list-style-type: none"> <li>-- Soap-filled steel wool pad</li> <li>-- Lestoil®</li> <li>-- Other degreaser</li> </ul> </li> </ul>
Igniters / ceramic	<ul style="list-style-type: none"> <li>• <b>DO NOT</b> use sharp tools to scrape the igniters. The igniters are fragile. If an igniter is damaged, it may not light the burner.</li> <li>• Suggested cleaners: <ul style="list-style-type: none"> <li>-- Cotton swab dampened with soapy water</li> <li>-- Fantastik®</li> </ul> </li> </ul>

Part/material	Cleaning notes
Oven cavity / porcelain enamel on steel	<ul style="list-style-type: none"> <li>• Porcelain enamel is acid resistant, but not acid proof. Acid foods such as citrus juices, tomatoes, rhubarb, vinegar, alcohol or milk, should be wiped up and not allowed to bake onto the porcelain during the next use. Over a period of time, the porcelain may craze (get fine hairlike lines), this will not affect oven performance.</li> <li>• Apply cleaner to a damp sponge or cloth. Rub lightly. Rinse thoroughly and dry. If food has burned onto the oven and is difficult to remove, the spots can be soaked with a cloth saturated in a suggested cleaner. Close the door and allow it to soak until the food soil can be easily removed with a damp soapy cloth or mild abrasive.</li> <li>• Suggested cleaners; rinse and dry immediately: <ul style="list-style-type: none"> <li>-- Hot water and detergent</li> <li>-- Bar Keeper's Friend<sup>®</sup></li> <li>-- Vinegar and water</li> <li>-- Soft Scrub<sup>®</sup></li> <li>-- Bon-ami<sup>®</sup></li> </ul> </li> </ul>
Oven racks and rack guides	<ul style="list-style-type: none"> <li>• Some commercial oven cleaners cause darkening and discoloration. Test the cleaner on a small part of the rack and check for discoloration before cleaning the entire rack.</li> <li>• Oven racks will discolor if left in oven during self clean.</li> <li>• If the racks do not slide easily after being cleaned, dampen a paper towel with a small amount of cooking oil and rub it lightly over the side rails.</li> <li>• Suggested cleaners; rinse and dry immediately: <ul style="list-style-type: none"> <li>-- Hot water and detergent</li> <li>-- Vinegar and water</li> <li>-- Dishwasher safe</li> <li>-- Bar Keeper's Friend<sup>®</sup></li> <li>-- Soft Scrub<sup>®</sup></li> <li>-- Bon-ami<sup>®</sup></li> </ul> </li> <li>• Stubborn stains; rinse and dry immediately: <ul style="list-style-type: none"> <li>-- Soap-filled fiber or steel wool pad</li> </ul> </li> </ul>
Surface spill trays / porcelain enamel	<ul style="list-style-type: none"> <li>• The porcelain enamel finish is acid resistant, but not acid proof. Acidic foods, such as citrus juices, tomatoes, rhubarb, vinegar, alcohol or milk, should be wiped up and not allowed to bake onto the porcelain during the next use.</li> <li>• If mild abrasive cleaners are used, rub lightly as these cleansers may scratch the finish.</li> <li>• For burned on foods, soap filled fiber or steel wool pads may be used but care must be taken as these may scratch the finish.</li> <li>• Suggested cleaners; rinse and dry immediately: <ul style="list-style-type: none"> <li>-- Hot water and detergent</li> <li>-- Soft Scrub<sup>®</sup></li> <li>-- Bar Keeper's Friend<sup>®</sup></li> <li>-- Bon-ami<sup>®</sup></li> </ul> </li> <li>• Stubborn stains; rinse and dry immediately: <ul style="list-style-type: none"> <li>-- Soap-filled fiber or steel wool pad</li> </ul> </li> </ul>
Seal / door gasket	<ul style="list-style-type: none"> <li>• Spray on cleaner and blot dry with a cloth. <b>DO NOT</b> rub. Do not move, remove or damage mesh.</li> <li>• Suggested cleaners; rinse and dry immediately: <ul style="list-style-type: none"> <li>-- Hot water and detergent</li> <li>-- Fantastik<sup>®</sup></li> </ul> </li> </ul>

# Do-it-yourself maintenance

## Oven light bulb replacement

### ⚠ CAUTION

- Make sure the appliance and lights are cool and power to the appliance has been turned off before replacing the light bulb(s). Failure to do so could result in electrical shock or burns.
- The covers must be in place when using the appliance.
- The covers serve to protect the light bulb from breaking.
- The covers are made of glass. Handle carefully to avoid breaking. Broken glass could cause an injury.
- The light socket is live when the door is open.

Replace only with a recommended light bulb designed for appliance oven use. **DO NOT** use a standard household light bulb in any oven. Call Thermador Customer Care Center at 1-800-735-4328 or your nearest Thermador dealer to determine the proper replacement bulb for your range. You will need to know your range's model number and serial number.

### To replace the light bulb

Use only 10W, 12V G4 light bulbs. Use a clean, dry cloth to handle halogen light bulbs. This will increase the life of the bulb.

1. Turn off circuit breaker.
2. Remove the oven racks.
3. Slide the tip of a flat blade screw driver between the holder clip and the lamp housing (figure, a).
4. Support the glass lens cover with fingers along the bottom edge to prevent the cover from falling to the bottom of the oven. Gently twist the flat blade screw driver to loosen the glass lens cover.

5. Remove the glass lens cover.
6. Remove the bulb by grasping and sliding the bulb straight back until the two prongs have cleared the ceramic holder (figure, b).
7. **DO NOT** touch the glass of the new replacement bulb with your fingers. It may cause the bulb to fail when it first lights. Grasp the replacement bulb with a clean dry cloth. Locate the two prongs in the ceramic holder, gently poking until the two prongs locate in the ceramic socket.
8. Press down to seat the bulb (figure, c).
9. Slide the protective lens into the holder clip and push the other end until the fixing clip snaps back into the housing (figure, d).

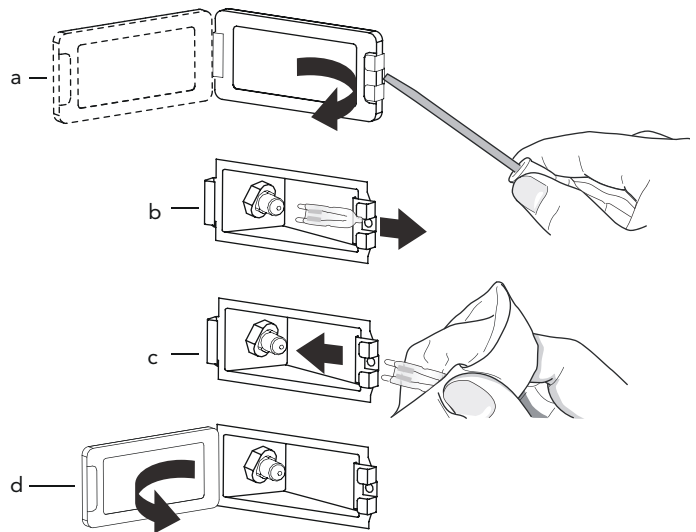

10. Turn on circuit breaker.

# Before calling for service

Before calling for service, check the following to avoid unnecessary service charges.

## Troubleshooting

Symptom	Possible cause	Remedy
Intermittent igniter sparking	<ul style="list-style-type: none"><li>• Ceramic igniter is wet or dirty.</li><li>• Burner ports are clogged.</li></ul>	<ul style="list-style-type: none"><li>• Carefully dry or clean igniter.</li><li>• Clean ports on burner cap with a wire, a needle or straightened paper clip.</li></ul>
More than four clicks of igniter before lighting	<ul style="list-style-type: none"><li>• Improper fit of burner cap onto burner base.</li></ul>	<ul style="list-style-type: none"><li>• Align burner cap properly on burner base.</li></ul>
Constant igniter sparking	<ul style="list-style-type: none"><li>• Range is not properly grounded.</li><li>• Electrical power supply is incorrectly polarized.</li></ul>	<ul style="list-style-type: none"><li>• Refer to the Installation Instructions. Have a qualified electrician ground the range properly.</li></ul>
Igniters sparking but no flame ignition.	<ul style="list-style-type: none"><li>• Gas supply valve is in "OFF" position.</li></ul>	<ul style="list-style-type: none"><li>• Restore gas supply to the unit.</li></ul>
Range will not operate (lights, oven, and surface burners will not come on)	<ul style="list-style-type: none"><li>• No power to the unit.</li><li>• Oven is in Sabbath mode.</li></ul>	<ul style="list-style-type: none"><li>• Check for open circuit breaker.</li><li>• Check that power supply line connection is connected to the proper voltage.</li><li>• Verify that the oven is not in sabbath mode. See the "Using the oven" section of the Use and Care Guide.</li></ul>
Oven operates on bake but fails to operate on timed bake	<ul style="list-style-type: none"><li>• Timer improperly set.</li></ul>	<ul style="list-style-type: none"><li>• Set timer as outlined in the Use and Care Guide.</li></ul>
Oven light fails to come on.	<ul style="list-style-type: none"><li>• Oven light burned out.</li></ul>	<ul style="list-style-type: none"><li>• Replace the oven light as outlined in the Use and Care Guide.</li></ul>
Door will not open.	<ul style="list-style-type: none"><li>• Oven is still in self-clean mode.</li></ul>	<ul style="list-style-type: none"><li>• If oven is hot, door latch will release when safe temperature is reached.</li></ul>
Foods in oven are not cooking sufficiently.	<ul style="list-style-type: none"><li>• Rack position is incorrect.</li><li>• Improper cookware.</li><li>• Oven door may not be sealing properly.</li><li>• Appliance not level.</li></ul>	<ul style="list-style-type: none"><li>• See the "Using the oven" section of the Use and Care Guide.</li><li>• Refer to "Cookware recommendations" in the Use and Care Guide.</li><li>• Clean the oven door gasket. Replace if worn.</li><li>• Refer to the Installation Instructions for instructions on how to level the appliance.</li></ul>
Hot air is coming from the appliance.	<ul style="list-style-type: none"><li>• It is normal for the cooling process to push heated air out into the room when the oven is on.</li><li>• During different modes the fan speed will increase and decrease.</li></ul>	<ul style="list-style-type: none"><li>• This is normal.</li></ul>



# Service information

## ⚠ CAUTION

Before removing the toe kick panel, disconnect the range from the electrical power supply. Reinstall the toe kick panel before reconnecting the range to the power supply and operating the range.

### Electric wiring diagrams and schematics

The electric wiring diagrams and schematics are attached behind the toe kick, and should not be removed except by a service technician, then replaced after service.

### Data rating label

The data rating label shows the model and serial number of your appliance. The slide-out plate can be accessed by first removing the kick panel, as shown below.

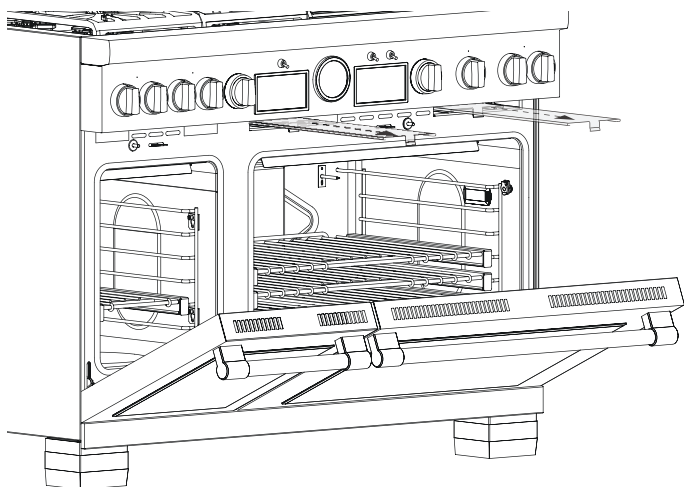

For handy reference, copy the information below from the data rating label. Keep your invoice for warranty validation.

Model number \_\_\_\_\_

Serial number \_\_\_\_\_

Date of purchase \_\_\_\_\_

# Remote customer service connection

It is possible for customer service to access the appliance via the Home Connect™ connection in the event of an error.

### To grant customer service access to the appliance

1. Contact customer support (see back page). Follow the instructions given to you by the technician.
  - The display screen as customer support tries to gain access to the appliance.

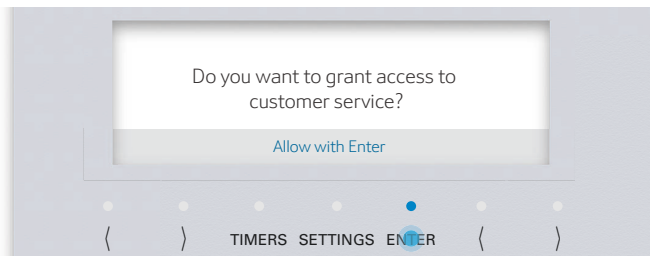

2. Press **ENTER** to allow the customer support access.
  - Once connection is established the Wi-Fi icon is shown in the status bar.

# Product registration

Register your BSH product to ensure timely service and access to your product related information.

### You may register your product through one of the following ways:

- Register with your phone (USA only).
  1. Take a photo of the camera icon on the registration card, including the points (Ⓞ).

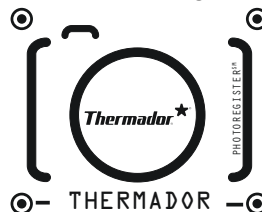

2.  Text the photo to 21432. (USA only, text and data rates may apply.)
- Mail in the completed product registration card to the address printed on the card.
  - Register your product online at [www.thermador.com](http://www.thermador.com).
  - Call Thermador customer service at 1-800-735-4328.

# Statement of limited product warranty

## What this warranty covers and who it applies to

The limited warranty provided by BSH Home Appliances ("Thermador") in this Statement of Limited Product Warranty applies only to the Thermador appliance sold to you, the first using purchaser, provided that the Product was purchased:

- For your normal, household (non-commercial) use, and has in fact at all times only been used for normal household purposes.
- New at retail (not a display, "as is", or previously returned model), and not for resale, or commercial use.
- Within the United States or Canada, and has at all times remained within the country of original purchase.

The warranties stated herein apply to the original purchaser of the product warranted herein and to each succeeding owner of the product purchased for ordinary home use during the term of the warranty.

Please make sure to return your registration card; while not necessary to effectuate warranty coverage, it is the best way for Thermador to notify you in the unlikely event of a safety notice or product recall.

## How long the warranty lasts

Thermador warrants that the Product is free from defects in materials and workmanship for a period of seven hundred and thirty (730) days from the date of purchase. The foregoing timeline begins to run upon the date of purchase, and shall not be stalled, tolled, extended, or suspended, for any reason whatsoever.

This Product is also warranted to be free from cosmetic defects in material and workmanship (such as scratches of stainless steel, paint/porcelain blemishes, chips, dents, or other damage to the finish) of the Product, for a period of sixty (60) days from the date of purchase or closing date for new construction. This cosmetic warranty excludes slight color variations due to inherent differences in painted and porcelain parts, as well as differences caused by kitchen lighting, product location, or other similar factors. This cosmetic warranty specifically excludes any display, floor, "As Is", or "B" stock appliances.

## Repair/replace as your exclusive remedy

During this warranty period, Thermador or one of its authorized service providers will repair your Product without charge to you (subject to certain limitations stated herein) if your Product proves to have been manufactured with a defect in materials or workmanship. If reasonable attempts to repair the Product have been made without success, then Thermador will replace your Product (upgraded models may be available to you, in Thermador's sole discretion, for an additional charge). All removed parts and components shall become the property of Thermador at its sole option. All replaced and/or repaired parts shall assume the identity of the original part for purposes of this warranty and this warranty shall not be extended with respect to such parts.

Thermador's sole liability and responsibility hereunder is to repair manufacturer-defective Product only, using a Thermador authorized service provider during normal business hours.

For safety and property damage concerns, Thermador highly recommends that you do not attempt to repair the Product yourself, or use an unauthorized servicer; Thermador will have no responsibility or liability for repairs or work performed by a non-authorized servicer. If you choose to have someone other than an authorized service provider work on your Product, THIS WARRANTY WILL AUTOMATICALLY BECOME NULL AND VOID. Authorized service providers are those persons or companies that have been specially trained on Thermador products, and who possess, in Thermador's opinion, a superior reputation for customer service and technical ability (note that they are independent entities and are not agents, partners, affiliates or representatives of Thermador). Notwithstanding the foregoing, Thermador will not incur any liability, or have responsibility, for the Product if it is located in a remote area (more than 100 miles from an authorized service provider) or is reasonably inaccessible, hazardous, threatening, or treacherous locale, surroundings, or environment; in any such event, if you request, Thermador would still pay for labor and parts and ship the parts to the nearest authorized service provider, but you would still be fully liable and responsible for any travel time or other special charges by the service company, assuming they agree to make the service call.

## Out of warranty product

Thermador is under no obligation, at law or otherwise, to provide you with any concessions, including repairs, pro-rates, or Product replacement, once this warranty has expired.

## Warranty exclusions

The warranty coverage described herein excludes all defects or damage that are not the direct fault of Thermador, including without limitation, one or more of the following:

- Use of the Product in anything other than its normal, customary and intended manner (including without limitation, any form of commercial use, use or storage of an indoor product outdoors, use of the Product in conjunction with air or water-going vessels).
- Any party's willful misconduct, negligence, misuse, abuse, accidents, neglect, improper operation, failure to maintain, improper or negligent installation, tampering, failure to follow operating instructions, mishandling, unauthorized service (including self-performed "fixing" or exploration of the appliance's internal workings).
- Adjustment, alteration or modification of any kind.
- A failure to comply with any applicable state, local, city, or county electrical, plumbing and/or building codes, regulations, or laws, including failure to install the product in strict conformity with local fire and building codes and regulations.
- Ordinary wear and tear, spills of food, liquid, grease accumulations, or other substances that accumulate on, in, or around the Product.
- Any external, elemental and/or environmental forces and factors, including without limitation, rain, wind, sand, floods, fires, mud slides, freezing temperatures, excessive moisture or extended exposure to humidity, lightning, power surges, structural failures surrounding the appliance, and acts of God.

In no event shall Thermador have any liability or responsibility whatsoever for damage to surrounding property, including cabinetry, floors, ceilings, and other structures or objects around the Product. Also excluded from this warranty are products on which the serial numbers have been altered, defaced, or removed; service visits to teach you how to use the Product, or visits where there is nothing wrong with the Product; correction of installation problems (you are solely responsible for any structure and setting for the Product, including all electrical, plumbing or other connecting facilities, for proper foundation/flooring, and for any alterations including without limitation cabinetry, walls, floors, shelving, etc.); and resetting of breakers or fuses.

TO THE EXTENT ALLOWED BY LAW, THIS WARRANTY SETS OUT YOUR EXCLUSIVE REMEDIES WITH RESPECT TO PRODUCT, WHETHER THE CLAIM ARISES IN CONTRACT OR TORT (INCLUDING STRICT LIABILITY, OR NEGLIGENCE) OR OTHERWISE. THIS WARRANTY IS IN LIEU OF ALL OTHER WARRANTIES, WHETHER EXPRESS OR IMPLIED. ANY WARRANTY IMPLIED BY LAW, WHETHER FOR MERCHANTABILITY OR FITNESS FOR A PARTICULAR PURPOSE, OR OTHERWISE, SHALL BE EFFECTIVE ONLY FOR THE PERIOD THAT THIS EXPRESS LIMITED WARRANTY IS EFFECTIVE. IN NO EVENT WILL THE MANUFACTURER BE LIABLE FOR CONSEQUENTIAL, SPECIAL, INCIDENTAL, INDIRECT, "BUSINESS LOSS", AND/OR PUNITIVE DAMAGES, LOSSES, OR EXPENSES, INCLUDING WITHOUT LIMITATION TIME AWAY FROM WORK, HOTELS AND/OR RESTAURANT MEALS, REMODELLING EXPENSES IN EXCESS OF DIRECT DAMAGES WHICH ARE DEFINITELY CAUSED EXCLUSIVELY BY THERMADOR, OR OTHERWISE. SOME STATES DO NOT ALLOW THE EXCLUSION OR LIMITATION OF INCIDENTAL OR CONSEQUENTIAL DAMAGES, AND SOME STATES DO NOT ALLOW LIMITATIONS ON HOW LONG AN IMPLIED WARRANTY LASTS, SO THE ABOVE LIMITATIONS MAY NOT APPLY TO YOU. THIS WARRANTY GIVES YOU SPECIFIC LEGAL RIGHTS, AND YOU MAY ALSO HAVE OTHER RIGHTS WHICH VARY FROM STATE TO STATE.

No attempt to alter, modify or amend this warranty shall be effective unless authorized in writing by an officer of BSH.



## Support

Thank you for being a Thermador customer!

Thermador is dedicated to supporting you and your appliance so you have many years of creative cooking. Please don't hesitate to contact us if you have any questions. We're happy to help you with cleaning and care instructions, cooking tips, accessories, troubleshooting, and more.

### USA:

1-800-735-4328

[thermador.com/customer-care](http://thermador.com/customer-care)

### Canada:

1-800-735-4328

[thermador.ca/support](http://thermador.ca/support)

## Accessories and parts

Filters, Thermador cleaners, teppanyaki pans, griddles, replacement parts, and more can be purchased in our online accessories store.

### USA:

[store.thermador.com/us](http://store.thermador.com/us)

### Canada:

Filters, parts and accessories can be purchased through our distributors.

Marcone: 1-800-287-1627

Reliable Parts: 1-800-663-6060



1901 MAIN STREET, SUITE 600, IRVINE, CA 92614 // 800-735-4328 // [WWW.THERMADOR.COM](http://WWW.THERMADOR.COM)

© 2019 BSH Home Appliances Corporation

8001146562, Rev. B