



### 1) DESCRIPTION AND COMPATIBILITY

The Amana PHWT-A200 is a programmable electronic thermostat, which can be used with the following heating/cooling applications:

- Cooling/ Conventional PTAC Units (PTC) with or without Electric Heat
- Heat Pump PTAC Units (PTH or HEH) with or without Electric Heat

### 2) SPECIFICATIONS

- Input Voltage: 19 to 30 VAC
- Output Rating: Max. 1.5A per terminal (3A total)
- Temperature Control: 45°F to 90°F (7°C to 32°C)
- Temperature Accuracy:  $\pm 1^\circ\text{F}$  ( $\pm 0.5^\circ\text{C}$ )
- Wire Terminals:

C	24 VAC Common
GL	Fan LOW Speed
GH	Fan HIGH Speed
W2	2nd Stage or Auxiliary Heating Signal
W1	1st Stage Heating Signal
Y	Cooling Signal
R	24 VAC Hot
B/O	Reversing Valve

### 3) SAFETY INFORMATION

- This thermostat is for LOW voltage applications only.
- Turn OFF electricity to all heating and cooling components.
- All wiring must conform to applicable local and national building and electrical codes and ordinances.

### 4) TO REMOVE EXISTING THERMOSTAT

1. Write down the letters printed near each wire terminal that is used, and the color of each wire it is connected to; self-adhesive wire labels are also enclosed.
2. Carefully remove wires from existing thermostat and bend so they cannot fall back into wall or touch each other.
3. Remove existing thermostat base from the wall.

### 5) TO INSTALL NEW THERMOSTAT

1. Mount the thermostat on an inside wall about five feet above the floor in an area that has good circulation, but is not directly affected by a vent or duct.
2. If painting or construction is still ongoing, cover the thermostat completely or wait until work is complete before mounting thermostat.
3. If new mounting holes are needed, mark the placement of the new mounting holes through the thermostat base. Using a 3/16" drill bit, drill the holes you have marked and insert the supplied wall anchors.
4. Feed the wires through the wire opening in the base and use supplied screws to mount base to the wall.
5. Using Section 7) WIRING DIAGRAMS, wire each terminal on the new thermostat base. Ensure that the bare end is fully seated into the connector, then tighten securely. Pull gently on wires to ensure they are secure.
6. Place thermostat front back onto the base.
7. Restore power back to heating and cooling components and thermostat.
8. See Section 8) INSTALLER SETTINGS MENU, to adjust the required settings needed for each system type.

## 6) FRONT PANEL CONTROLS

### THERMOSTAT SYSTEM MODE BUTTON:

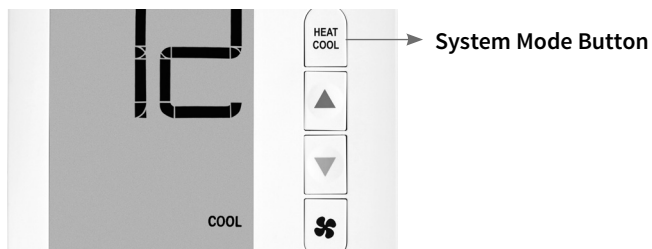

Press System Mode button until desired mode is underlined, after 2 seconds with no button press the underlined system mode is entered.

**AUTO** = automatically selects heat/cool mode as

needed (may be disabled in installer settings)

**OFF** = thermostat stops all heating or cooling functions

**HEAT** = thermostat permits heating operation

**COOL** = thermostat permits cooling operation

### THERMOSTAT FAN BUTTON:

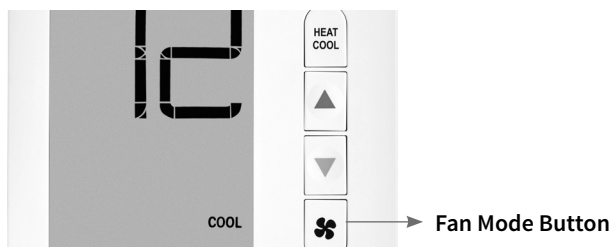

Press Fan Mode button until desired mode is underlined, after 2 seconds with no button press the underlined fan mode is entered.

**FAN AUTO** = fan operates in low or high speed mode as needed during a call for heating or cooling activation only.

**FAN LOW** = fan operates continuously in LOW speed, with the heating or cooling components cycling on and off in the background as needed.

**FAN HIGH** = fan operates continuously in HIGH speed, with the heating or cooling components cycling on and off in the background as needed.

### UP AND DOWN BUTTONS:

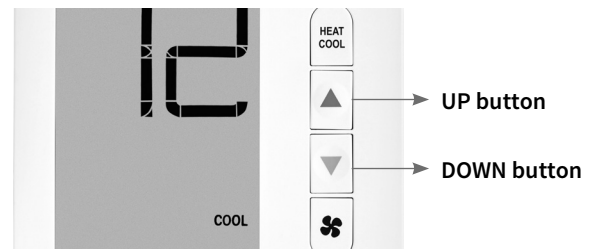

**UP / DOWN** = used for raising or lowering the target set temperature and selecting user options and settings in the display screen.

The temperature that is shown at all times in normal operation is the target set temperature.

To view current ambient room temperature while in Auto, Heat, or Cool mode, perform a single press of BOTH the Up and Down buttons at the same time.

*Note: to adjust the target set temperature, first ensure that the thermostat is in either Auto, Heat, or Cool mode, and press either the Up or Down buttons until the desired target temperature is reached. Presses to the Up or Down buttons will have no effect when the thermostat is in Off mode.*

7) WIRING DIAGRAMS

**UP TO 2H/1C HEAT PUMP APPLICATIONS:  
(AMANA PTH & HEH PTAC MODELS):**

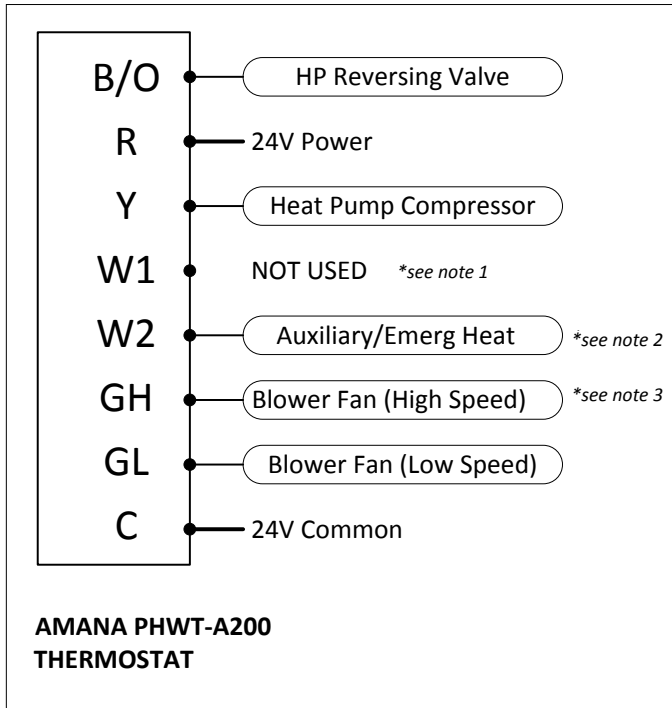

**\* HEAT PUMP WIRING DIAGRAM NOTES:**

- Note 1: When configured for Heat Pump operation, the “Y” terminal will be called for during both cooling and first-stage heating operation. Do not connect any wires to the “W1” terminal.
- Note 2: The “W2” terminal is used to call for Electric/ Auxiliary heat. If your Heat Pump PTAC does not have Electric heat, then the “W2” terminal should not be used and Installer Settings menu 10 (Aux. Stage Offset) should be set to “OFF”.
- Note 3: For PTAC units with only one fan speed (single “G” fan wire), use the “GL” terminal for wiring and Installer Settings menu 12 (High Fan) must be set to "OFF".

**UP TO 1H/1C CONVENTIONAL APPLICATIONS:  
(AMANA PTC PTAC MODELS) \*\* see note 1**

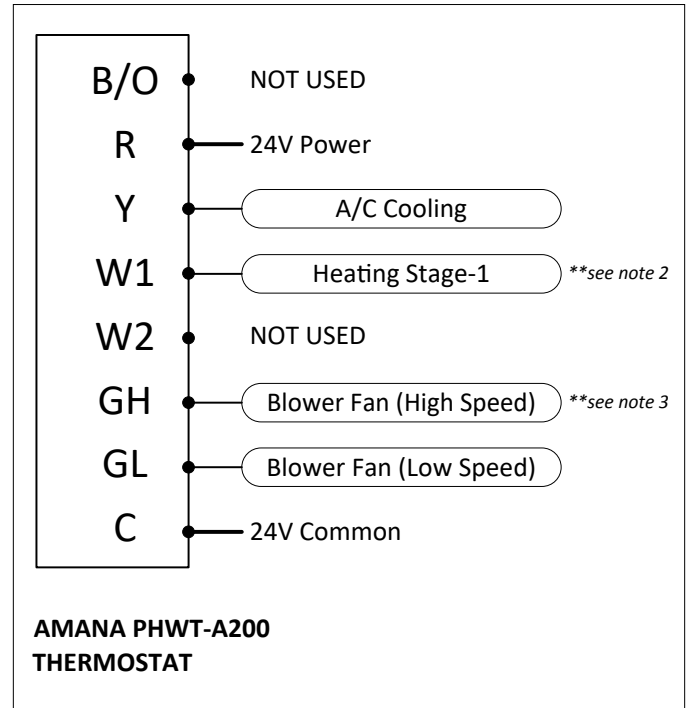

**\*\* CONVENTIONAL WIRING DIAGRAM NOTES:**

- Note 1: For Conventional (cooling) PTAC units, Installer Settings menu 06 (System Type) must be set to “Con”.
- Note 2: If connecting to a Conventional PTAC unit without electric heat, the W1 and W2 wire terminals will not be used and Installer Settings menu 03 (Available Modes) should be set to “04: Cool Only”
- Note 3: For PTAC units with only one fan speed (single “G” fan wire), use the “GL” terminal for wiring and Installer Settings menu Item 12 (High Fan) must be set to “OFF”.

## 8) INSTALLER SETTINGS

*NOTE: Waiting 1-Minute with no button presses will exit the installer settings menu with all items saved as they were last shown on the display screen.*

### TO ENTER INSTALLER SETTINGS MENU:

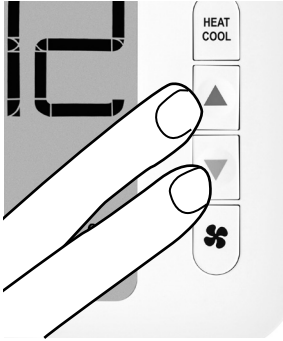

With thermostat powered, press System Mode button until **OFF** is underlined. After OFF mode is confirmed, press and hold BOTH the Up and Down buttons for at least 5 seconds until the screen changes.

### TO CHANGE AN ENTRY:

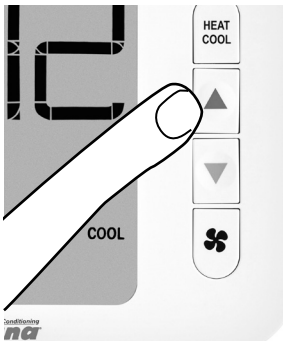

Use the Up or Down buttons to change the setting option.

### TO ADVANCE TO THE NEXT MENU ITEM:

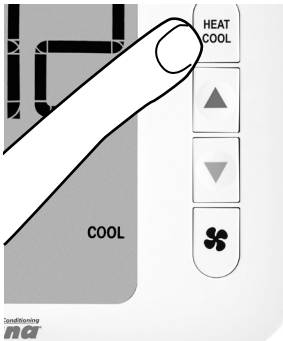

Press the Mode button one time to advance to the next item in the menu.

### TO RETURN TO THE MAIN THERMOSTAT SCREEN:

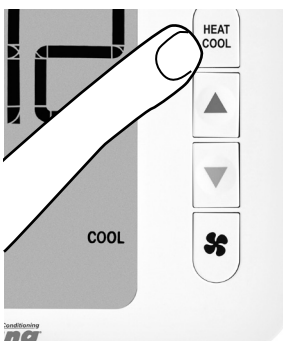

While at the last menu item, press the System Mode button one more time to exit the Installer Settings menu.

## SOFTWARE CONFIGURATION SETTINGS

MENU#	SETTING	OPTIONS
01	Scale	F, C
02	Temp. Calibration	<b>Zero</b> , -5F to +5F (-3C to +3C)
03	Available Modes	<b>01: Heat, Cool, Auto</b> 02: Heat, Cool 03: Heat Only 04: Cool Only
04	Max. Heat	60F to 90F ( <b>80F</b> ) (16C to 32C)
05	Min. Cool	60F to 80F ( <b>65F</b> ) (16C to 27C)
06	System Type	<b>HP=Heat Pump</b> Con=Conventional
07	HP Valve Type	<b>B: Valve on in Heat</b> O: Valve on in Cool
08	Auto Dead-Band	2.0F (1.11C) 3.0F (1.67C) <b>4.0F (2.22C)</b> 5.0F (2.78C)
09	Swing / Temp. Differential	±0.25F (±0.14C) <b>±0.50F (±0.28C)</b> ±1.00F (±0.56C) ±2.25F (±1.25C)
10	Aux. Stage Offset (for Heat Pumps only)	Off 1: 1.0F (0.5C) 2: 2.0F (1.0C) 3: 3.0F (1.5C) <b>4: 4.0F (2.0C)</b> 5: 5.0F (2.5C)
--		
12	High Fan	<b>On: Available</b> Off: Disabled
13	Programming	<b>Off: Manual</b> On: Programmable
14	Clock Format (see note #1)	<b>12: AM/PM</b> 24: 24 Hr. Military
15	Periods per/Day (see note #1)	4: 4-Periods <b>2: 2-Periods</b> 1: 1-Period
16	Auto Daylight Savings (see note #1)	<b>On: Auto DST</b> Off: Manual
17	Backlight Always On	<b>Off=Turn off 10 sec</b> On=Always On
18	Use default set temp. after mode change (see note #2)	<b>ON: Uses default temps</b> OFF: Use last temp per mode
19	Default heat mode set temp (see note #2)	<b>70F (21C)</b> 60F to max heat set temp
20	Default cool mode set temp (see note #2)	<b>74F (23C)</b> 80F to min cool set temp
--		
98	Compressor Protection Bypass	<b>No=Delays Remain</b> Yes=Suspend Delay
99	RESET	<b>No=Save and Exit</b> Yes=Full Reset

*NOTES: (#1) For Programmable operation only.  
(#2) For Non-Programmable operation only.*

### SETTING DESCRIPTIONS:

- 01 (Scale):** Displayed temperatures shown in F/C degrees.
- 02 (Temp. Calibration):** Gives user flexibility to adjust the perceived measured temperature that is used for thermal control.
- 03 (Available Modes):** Determines which system modes are available to the user when pressing the System Mode button.
- 04 (Max. Heat):** Sets the maximum temperature that a user can adjust the target temperature to for heating.
- 05 (Min. Cool):** Sets the minimum temperature that a user can adjust the target temperature to for cooling.
- 06 (System Type):** Selects the type of heating/cooling equipment that is present in the system.
- 07 (Heat Pump Valve Type):** Determines if the combined O/B terminal operates as "B" (energized while in Heat mode), or as "O" (energized while in Cool mode).
- 08 (Auto Dead-Band):** Determines the amount of temperature separation needed for Auto Mode to change between Heat and Cool modes
- 09 (Swing / Temp. Differential):** Determines how wide or narrow the temperature control band is between cut-in and cut-out.
- 10 (Aux. Stage Offset):** Sets the number of degrees from the setpoint, that will cause the second heat stage to turn on.
- 12 (High Fan):** Permits or prevents the capability for using the high-speed fan mode.
- 13 (Programming):** Determines if the thermostat acts as a programmable thermostat with period changes during the day, or manual operation only.
- 14 (Clock Format):** Determines the appearance and usage of the clock digits, either AM and PM, or 24hr military time.
- 15 (Periods per/Day):** Sets the quantity of temperature periods used per programming day.
- 16 (Auto Daylight Savings):** Determines if the thermostat automatically adjusts the clock for Daylight Savings Time or requires manual adjustment in the spring and fall.
- 17 (Backlight Always On):** Allows the display backlight to remain on constantly or turn off automatically after 10 seconds.
- 18 (Set Temp After Mode Change):** Determines if the thermostat recalls the last used set temperature per mode or uses a default set temperature when the mode is changed manually.
- 19 (Default Heat Mode Set Temp):** Determines the default set temperature that is used when first selecting heat mode.
- 20 (Default Cool Mode Set Temp):** Determines the default set temperature that is used when first selecting cool mode.
- 98 (Delay Bypass):** Contractor/Installer mode, turns off the compressor delays for testing the system; returns automatically to normal operation after 5 minutes.
- 99 (RESET):** Returns all settings back to factory defaults.

## 9) AUTOMATIC DAYLIGHT SAVINGS TIME

By default, the thermostat will automatically adjust the clock for Daylight Savings. This can be disabled by changing the Auto Daylight Savings (setting 16) option in the installer menu.

## 10) SET CLOCK AND TEMPERATURE PROGRAM SCHEDULE

*NOTE: Waiting 1-Minute with no button presses will exit the settings menu, with all items saved as they were last shown on the display screen.*

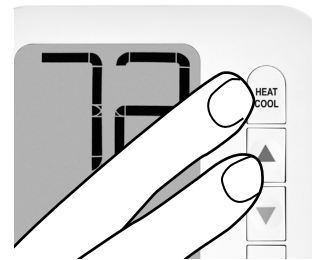

With thermostat powered, press System Mode button until **OFF** is underlined. After OFF mode is confirmed, press and hold BOTH the Menu and Up buttons for at least 5 seconds until the screen changes.

Use Up or Down buttons to move the underline with the selection item you want to adjust and then press the System Mode button one time to enter selection.

**CLOCK DIGITS** = adjusts the current real-time clock.  
**HEAT** = programming area to adjust the heating temperature set points for each day and period.  
**COOL** = programming area to adjust the cooling temperature set points for each day and period.  
**EXIT?** = exits the clock and programming menu and returns thermostat to the main home screen in Off mode.

## 11) ADJUSTING THE REAL-TIME CLOCK

- Upon entering clock settings, the blinking **hour** digits are adjusted using the Up or Down buttons. Continue to press either Up or Down to cycle all the way around and swap between AM and PM as needed.
- Press the Menu button to advance to setting the **minutes**, using the Up/Down buttons to change value.
- Press the Menu button to advance to setting the **year**, using the Up/Down buttons to change value.
- Press the Menu button to advance to setting the **month**, using the Up/Down buttons to change value.
- Press the Menu button to advance to setting the **day**, using the Up/Down buttons to change value.

## 12) ADJUSTING THE HEAT OR COOL TEMPERATURE PROGRAM

- Each period ends at the start time of the next upcoming period.  
NOTE: If configured to use only 2 periods, only DAY and NIGHT will be used, and the MORN and EVEN periods will not be used or visible. If you use 1 period and 7 day programming, then thermostat will reset to the desired set temperature at the same time each day.
- Upon entering either HEAT or COOL programming sections, choose which day[s] you would like to adjust with the same settings (i.e. all weekdays together, or each day separately). Use the Up/Down buttons to scroll through the blinking days and press the Menu button to select each day with an underline. Once all desired days are selected, move blinking selection to **PROG?** and press the Menu button to proceed.
- Adjust the start time of the first program period using Up/Down buttons and press the Menu button to advance. Adjust the start time of the first program period using Up/Down buttons and press the Menu button to advance.
- Use this same step-by-step process to adjust the remaining periods for the day or group of days being adjusted.
- When all periods have been adjusted, the screen will blink **EXIT?** If you are not yet done with adjusting other days, you can use Up/Down to select other days with an underline just like above and repeat the same process. If you are done, press the Menu button to exit the programming menu. These steps performed apply only to the mode you have just programmed. If necessary, please repeat programming process for alternative mode.
- If you are all done performing setting changes, move the underline to **EXIT?** and press the Menu button to return to the main home screen.

		4-Periods	2-Periods	1-Period
<b>MORN</b>	Time HEAT COOL	6:00 AM 70F 78F		
<b>DAY</b>	Time HEAT COOL	8:00 AM 62F 82F	8:00 AM 70F 74F	10:00 AM 70F 74F
<b>EVEN</b>	Time HEAT COOL	6:00 PM 70F 78F		
<b>NIGHT</b>	Time HEAT COOL	10:00 PM 62F 75F	6:00 PM 62F 82F	

## 13) ENTERING EMERGENCY HEAT MODE (HP UNITS ONLY)

- While in regular HEAT mode, press and hold BOTH the Mode and Fan buttons for at least 5 seconds, until the screen changes. The thermostat will show **HEAT** with “**E**” to confirm Emergency Heat mode. This will use only the W2 wire terminal as the heating source and will not call for compressor heating.
- To return to normal heating mode, press and hold BOTH the Mode and Fan buttons for at least 5 seconds until the screen changes. The “**E**” will disappear and only show “**HEAT**” to confirm regular Heat mode.

## 14) SETTING A KEYPAD / FRONT PANEL LOCKOUT

- While in any normal operating mode except OFF, a keypad lockout can be introduced which will prevent any mode change, fan change or temperature adjustment from being made by the user. Even when locked, any button press will illuminate the display backlight.
- To activate (and deactivate) the keypad lockout, press and hold BOTH the MODE and FAN buttons for at least 5 seconds. When the keypad is locked, a **padlock** will appear in the lower left corner of the display.