



Self-Cleaning Gas Ranges

Owner's Manual

Safety Information2

Warranty8

Assistance / Accessories9

Using The Cooktop

Surface Burners.....10

Griddle.....12

Using The Oven

Oven Controls.....14

Oven Air Vents15

Special Features16

Oven Racks and Rack Positions ...17

Cooking Modes18

Cookware.....19

Cooking Guide20

Warming Drawer Guide21

Care and Cleaning

Cleaning the Oven22

Cleaning The Cooktop24

Cleaning The Door and Drawer ...27

Maintenance.....28

Troubleshooting Tips29

For a Spanish version of this manual, visit our Website at GEAppliances.com.

Para consultar una version en español de este manual de instrucciones, visite nuestro sitio de internet GEAppliances.com.

In Canada contact us at: www.GEAppliances.ca

Write the model and serial numbers here:

Model # _____

Serial # _____

You can find them on a label on the side trim or on the front of the (lower) oven behind the oven door.

IMPORTANT SAFETY INFORMATION. READ ALL INSTRUCTIONS BEFORE USING.

⚠ WARNING If the information in this manual is not followed exactly, a fire or explosion may result, causing property damage, personal injury or death.

- Do not store or use gasoline or other flammable vapors and liquids in the vicinity of this or any other appliance.
- **WHAT TO DO IF YOU SMELL GAS**
 - Do not try to light any appliance.
 - Do not touch any electrical switch; do not use any phone in your building.
 - Immediately call your gas supplier from a neighbor's phone. Follow the gas supplier's instructions.
 - If you cannot reach your gas supplier, call the fire department.
- Installation and service must be performed by a qualified installer, service agency or the gas supplier.

ANTI-TIP DEVICE.



⚠ WARNING

Tip-Over Hazard

A child or adult can tip the range and be killed. Verify the anti-tip bracket has been properly installed and engaged. Ensure the anti-tip bracket is re-engaged when the range is moved. Do not operate the range without the anti-tip bracket in place and engaged. Failure to follow these instructions can result in death or serious burns to children or adults.

To reduce the risk of tipping the range, the range must be secured by a properly installed anti-tip bracket. See installation instructions shipped with the bracket for complete details before attempting to install.

For Freestanding and Slide-In Ranges

To check if the bracket is installed and engaged properly, look underneath the range to see that

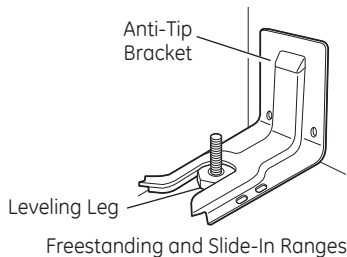

the rear leveling leg is engaged in the bracket. On some models, the storage drawer or kick panel can be removed for easy inspection. If visual inspection is not possible, slide the range forward, confirm the anti-tip bracket is securely attached to the floor or wall, and slide the range back so the rear leveling leg is under the anti-tip bracket.

If the range is pulled from the wall for any reason, always repeat this procedure to verify the range is properly secured by the anti-tip bracket.

Never completely remove the leveling legs or the range will not be secured to the anti-tip device properly.

SAVE THESE INSTRUCTIONS

STATE OF CALIFORNIA PROPOSITION 65 WARNING

The California Safe Drinking Water and Toxic Enforcement Act requires the Governor of California to publish a list of substances known to the state to cause cancer, birth defects or other reproductive harm, and requires businesses to warn customers of potential exposure to such substances.

▲ WARNING This product contains one or more chemical known to the State of California to cause cancer, birth defects or other reproductive harm.

Self-clean ovens can cause low-level exposure to some of these substances, including carbon monoxide, during the cleaning cycle. Exposure can be minimized by venting with an open window or using a ventilation fan or hood.

▲ WARNING GENERAL SAFETY INSTRUCTIONS

▲ WARNING NEVER use this appliance as a space heater to heat or warm the room. Doing so may result in carbon monoxide poisoning and overheating of the oven.

- Use this appliance for its intended purpose as described in this owner's manual.
- Have your range installed and properly grounded by a qualified installer in accordance with the provided installation instructions. Any adjustment and service should be performed only by a qualified gas range installers or service technicians. Do not attempt to repair or replace any part of your range unless it is specifically recommended in this manual.
- Your range is shipped from the factory set for use with natural gas. It can be converted for use with LP gas. If required, these adjustments must be made by a qualified technician in accordance with the installation instructions and local codes. The agency performing this work assumes responsibility for the conversion.
- Have the installer show you the location of the range gas shut-off valve and how to turn it off if necessary.
- Plug your range into a 120-volt grounded outlet only. Do not remove the round grounding prong from the plug. If in doubt about the grounding of the home electrical system, it is your responsibility and obligation to have an ungrounded outlet replaced with a properly grounded, three prong outlet in accordance with the National Electrical Code. Do not use on extension cord with this appliance.
- Before performing any service, unplug the range or disconnect the power supply at the household distribution panel by removing the fuse or switching off the circuit breaker.
- Be sure all packing materials are removed from the range before operating to prevent ignition of these materials
- Avoid scratching or impacting glass doors, cooktops or control panels. Doing so may lead to glass breakage. Do not cook on a product with broken glass. Shock, fire or cuts may occur.
- Do not leave children alone—children should not be left alone or unattended in an area where an appliance is in use. They should never be allowed to climb, sit or stand on any part of the appliance.
- **▲ CAUTION** Do not store items of interest to children in cabinets above an oven - children climbing on the oven to reach items could be seriously injured.
- Do not allow anyone to climb, stand or hang on the oven door, drawer or cooktop. They could damage the range or tip it over causing severe injury or death.

SAVE THESE INSTRUCTIONS

IMPORTANT SAFETY INFORMATION. READ ALL INSTRUCTIONS BEFORE USING.

⚠ WARNING GENERAL SAFETY INSTRUCTIONS (CONT.)

- Never block the vents (air openings) of the range. They provide the air inlets and outlets that are necessary for the range to operate properly with correct combustion. Air openings are located at the rear of the cooktop, at the top and bottom of the oven door, and at the bottom of the range under the warming drawer, lower oven drawer or kick panel.
- Use only dry pot holders—moist or damp pot holders on hot surfaces may result in burns from steam. Do not let pot holders touch surface burners, burner grate, or oven heating element. Do not use a towel or other bulky cloth in place of pot holders.
- Do not touch the heating elements or the interior surface of the oven. These surfaces may be hot enough to burn even though they are dark in color. During and after use, do not touch, or let clothing or other flammable materials contact any interior area of the oven; allow sufficient time for cooling first. Other surfaces of the appliance may become hot enough to cause burns. Potentially hot surfaces include the burners, grates, oven vent opening, surfaces near the opening and crevices around the oven door.
- Do not heat unopened food containers. Pressure could build up and the container could burst, causing an injury.
- Cook meat and poultry thoroughly—meat to at least an internal temperature of 160°F and poultry to at least an internal temperature of 180°F. Cooking to these temperatures usually protects against foodborne illness.

⚠ WARNING KEEP FLAMMABLE MATERIALS AWAY FROM THE OVEN

Failure to do so may result in fire or personal injury.

- Do not store or use flammable materials in an oven or near the cooktop, including paper, plastic, pot holders, linens, wall coverings, curtains, drapes and gasoline or other flammable vapors and liquids.
- Never wear loose-fitting or hanging garments while using the appliance. Avoid storing commonly used items in cabinets above the range and be careful when reaching over the range. Clothing in close proximity to burners or hot surfaces may ignite causing severe burns.
- Do not let cooking grease or other flammable materials accumulate in or near the range. Grease in the oven or on the cooktop may ignite.
- Clean ventilating hoods frequently. Grease should not be allowed to accumulate on the hood or filter.

SAVE THESE INSTRUCTIONS

⚠ WARNING IN THE EVENT OF A FIRE, TAKE THE FOLLOWING STEPS TO PREVENT INJURY AND FIRE SPREADING

- Do not use water on grease fires. Never pick up a flaming pan. Turn the controls off. Smother a flaming pan on a surface burner by covering the pan completely with a well-fitting lid, cookie sheet or flat tray. If necessary, use a multi-purpose dry chemical or foam-type fire extinguisher.
- If there is a fire in the oven during baking, turn the oven off and keep the door closed until the fire goes out. If necessary, use a multi-purpose dry chemical or foam type fire extinguisher.
- If there is a fire in the oven during self-clean, turn the oven off and wait for the fire to go out. Do not force the door open. Introduction of fresh air at self-clean temperatures may lead to a burst of flame from the oven. Failure to follow this instruction may result in severe burns.

⚠ WARNING COOKTOP SAFETY INSTRUCTIONS

- Never leave the surface burners unattended at medium or high heat settings. Foods, especially oily foods, may ignite resulting in fire that could spread to surrounding cabinets.
- Never leave oil unattended while frying. If allowed to heat beyond its smoking point, oil may ignite resulting in fire that may spread to surrounding cabinets. Use a deep fat thermometer whenever possible to monitor oil temperature.
- To avoid oil spillover and fire, use a minimum amount of oil when shallow pan-frying and avoid cooking frozen foods with excessive amounts of ice.
- Use proper pan size and avoid pans that are unstable or easily tipped. Select cookware that is matched to the size of the burner. Burner flames should be adjusted so that they do not extend beyond the bottom of the pan. Excessive flame may be hazardous.
- Always use the LITE position when igniting the top burners and make sure the burners have ignited.
- When using glass/ceramic cookware, make sure it is suitable for cooktop service; others may break because of sudden change in temperature.
- To minimize the possibility of burns, ignition of flammable materials and spillage, the handle of a container should be turned toward the center of the range without extending over nearby burners.
- When preparing flaming foods under a hood, turn the fan on.
- Do not use a wok with a round metal support ring. The ring may trap heat and block air to the burner resulting in a carbon monoxide hazard.
- Do not attempt to lift the cooktop. Doing so may damage the gas tubing to the surface burners resulting in a gas leak and risk of fire.
- When disabling Lock Control (on some models), make sure the surface controls are set to the OFF position. This will prevent unintended gas flow from the burners.
- Do not use aluminum foil to cover the grates or line any part of the cooktop. Doing so may result in carbon monoxide poisoning, overheating of the cooktop surfaces, or a potential fire hazard.

SAVE THESE INSTRUCTIONS

IMPORTANT SAFETY INFORMATION. READ ALL INSTRUCTIONS BEFORE USING.

⚠ WARNING OVEN SAFETY INSTRUCTIONS

⚠ WARNING NEVER cover any slots, holes, or passages in the oven bottom or cover an entire rack with materials such as aluminum foil. Doing so blocks air flow through the oven and may cause carbon monoxide poisoning. Aluminum foil linings may also trap heat, causing a fire hazard.

- Use this appliance for its intended purpose as described in this owner's manual.
- Stand away from the range when opening the oven door. Hot air or steam which escapes can cause burns to hands, face and/or eyes.
- Keep the oven free from grease buildup. Grease in the oven may ignite.
- Place oven racks in desired location while oven is cool. If rack must be moved while oven is hot, be careful to avoid touching hot surfaces.
- Pull the oven rack to the stop-lock position when loading and unloading food from the oven. This helps prevent burns from touching hot surfaces of the door and oven walls.
- Do not leave items such as paper, cooking utensils or food in the oven when not in use. Items stored in an oven can ignite.
- Do not leave items on the cooktop near the oven vent which is in the center of the backguard. Items may overheat resulting in a risk of fire or burns.
- When using cooking or roasting bags in the oven, follow the manufacturer's directions.
- Never broil with door open. Open-door broiling is not permitted due to overheating of control knobs.

⚠ WARNING SELF-CLEANING OVEN SAFETY INSTRUCTIONS

The self-cleaning feature operates the oven at temperatures high enough to burn away food soils in the oven. Follow these instructions for safe operation.

- Do not touch oven surfaces during self-clean operation. Keep children away from the oven during self-cleaning. Failure to follow these instructions may cause burns.
- Before operating the self-clean cycle, remove pans, shiny metal oven racks and other utensils from the oven. Only porcelain-coated oven racks may be left in the oven. Do not use self-clean to clean other parts, such as grates.
- Before operating the self-clean cycle, wipe grease and food soils from the oven. Excessive amount of grease may ignite leading to smoke damage to your home.
- If the self-cleaning mode malfunctions, turn the oven off and disconnect the power supply. Have it serviced by a qualified technician.
- Do not use oven cleaners. No commercial oven cleaner or oven liner protective coating of any kind should be used in or around any part of the oven.

SAVE THESE INSTRUCTIONS

⚠ WARNING WARMING DRAWER SAFETY INSTRUCTIONS (Some models)

- The purpose of the warming drawer is to hold hot cooked foods at serving temperature. Bacteria will grow very rapidly in food that is between 40 and 140°F. Do not put cold food in warming drawer. Do not keep food in the warming drawer for more than 2 hours. Failure to follow these instructions may result in foodborne illness.
- Do not leave paper products, plastics, canned food or combustible materials in the drawer. They may ignite.
- Do not touch the heating element or the interior surface of the drawer. These surfaces may be hot enough to cause burns.
- Use care when opening the drawer. Open the drawer a crack and let hot air or steam escape before removing or replacing food. Hot air or steam that escapes can cause burns to hands, face and/or eyes.
- Do not use aluminum foil to line the warming drawer. Foil is an excellent heat insulator and will trap heat beneath it. This will upset the performance of the drawer and potentially cause a fire hazard.

SAVE THESE INSTRUCTIONS

Thank You! ... for your purchase of a GE Brand appliance.

Register Your Appliance: Register your new appliance on-line at your convenience!

www.geappliances.com/service_and_support/register/

Timely product registration will allow for enhanced communication and prompt service under the terms of your warranty, should the need arise. You may also mail in the pre-printed registration card included in the packing material.

GE Gas Range Warranty

GEAppliances.com

All warranty service is provided by our Factory Service Centers, or an authorized Customer Care® technician. To schedule service, on-line, visit us at www.geappliances.com/service_and_support/, or call 800.GE.CARES (800.432.2737). Please have serial number and model number available when calling for service.

Servicing your appliance may require the use of the onboard data port for diagnostics. This gives a GE factory service technician the ability to quickly diagnose any issues with your appliance and helps GE improve its products by providing GE with information on your appliance. If you do not want your appliance data to be sent to GE, please advise your technician not to submit the data to GE at the time of service.

For the period of one year from the date of the original purchase. GE will provide any part of the range which fails due to a defect in materials or workmanship. During this limited one-year warranty, GE will also provide, free of charge, all labor and in-home service to replace the defective part.

What GE will not cover:

- Service trips to your home to teach you how to use the product.
- Improper installation, delivery or maintenance.
- Failure of the product if it is abused, misused, modified or used for other than the intended purpose or used commercially.
- Replacement of house fuses or resetting of circuit breakers.
- Damage to the product caused by accident, fire, floods or acts of God.
- Incidental or consequential damage caused by possible defects with this appliance.
- Damage caused after delivery.
- Product not accessible to provide required service.

EXCLUSION OF IMPLIED WARRANTIES

Your sole and exclusive remedy is product repair as provided in this Limited Warranty. Any implied warranties, including the implied warranties of merchantability or fitness for a particular purpose, are limited to one year or the shortest period allowed by law.

This warranty is extended to the original purchaser and any succeeding owner for products purchased for home use within the USA. If the product is located in an area where service by a GE Authorized Servicer is not available, you may be responsible for a trip charge or you may be required to bring the product to an Authorized GE Service location for service. In Alaska, the warranty excludes the cost of shipping or service calls to your home.

Some states do not allow the exclusion or limitation of incidental or consequential damages. This warranty gives you specific legal rights, and you may also have other rights which vary from state to state. To know what your legal rights are, consult your local or state consumer affairs office or your state's Attorney General.

Warrantor: General Electric Company. Louisville, KY 40225

Extended Warranties: Purchase a GE extended warranty and learn about special discounts that are available while your warranty is still in effect. You can purchase it on-line anytime

www.geappliances.com/service_and_support/shop-for-extended-service-plans.htm

or call 800.626.2224 during normal business hours. GE Consumer Home Services will still be there after your warranty expires.

Staple your receipt here. Proof of the original purchase date is needed to obtain service under the warranty.

Have a question or need assistance with your appliance?

Try the GE Appliances Website (www.geappliances.com/service_and_support/) 24 hours a day, any day of the year! For greater convenience and faster service, you can now download Owner's Manuals, order parts or even schedule service on-line.

Schedule Service: Expert GE repair service is only one step away from your door. Get on-line and schedule your service at www.geappliances.com/service_and_support/ Or call 800.GE.CARES (800.432.2737) during normal business hours.

Parts and Accessories: Individuals qualified to service their own appliances can have parts or accessories sent directly to their homes (VISA, MasterCard and Discover cards are accepted). Order on-line today, 24 hours every day or by phone at 800.626.2002 during normal business hours.

Instructions contained in this manual cover procedures to be performed by any user. Other servicing generally should be referred to qualified service personnel. Caution must be exercised, since improper servicing may cause unsafe operation.

Real Life Design Studio: GE supports the Universal Design concept of products, services and environments that can be used by people of all ages, sizes and capabilities. We recognize the need to design for a wide range of physical and mental abilities and impairments. For details of GE's Universal Design applications, including kitchen design ideas for people with disabilities, check out our Website today. For the hearing impaired, please call 800.TDD.GEAC (800.833.4322).

Contact Us: If you are not satisfied with the service you receive from GE, contact us on our Website with all the details including your phone number, or write to:
General Manager, Customer Relations
GE Appliances, Appliance Park Louisville, KY 40225

Accessories

Looking For Something More?

GE offers a variety of accessories to improve your cooking and maintenance experiences!

To place an order visit us online at:

www.GEApplianceParts.com (U.S.) or www.GEAppliances.ca (Canada)

or call **800.626.2002** (U.S.) **800.661.1616** (Canada)

The following products and more are available:

Accessories

Small Broiler Pan (8 ¾" x 1 ¼" x 13 ½")	WB48X10055 (US) 222D2097G001 (Canada)
Large* Broiler Pan (12 ¾" x 1 ¼" x 16 ½")	WB48X10056 (US) 222D2097G002 (Canada)
XL** Broiler Pan (17" x 1 ¼" x 19 1/4")	WB48X10057 (US) Not available in Canada

Parts

Oven racks	Part numbers vary by model
Oven burners	Part numbers vary by model
Light bulbs	Part numbers vary by model

Cleaning Supplies

CitruShine Stainless Steel Wipes	WX10X10007
CeramaBryte Stainless Steel Appliance Cleaner	PM10X311

How to Remove Protective Shipping Film and Packaging Tape

Carefully grasp a corner of the protective shipping film with your fingers and slowly peel it from the appliance surface. Do not use any sharp items to remove the film. Remove all of the film before using the appliance for the first time.

To assure no damage is done to the finish of the product, the safest way to remove the adhesive from packaging tape on new appliances is an application of a household liquid dishwashing detergent. Apply with a soft cloth and allow to soak.

NOTE: The adhesive must be removed from all parts. It cannot be removed if it is baked on.

Surface Burners

How to Light a Surface Burner

⚠ WARNING Burners should be operated only when covered by cookware. Burner flames not covered by cookware present a risk of fire or clothing ignition. Never let flames extend beyond the sides of the cookware. Failure to comply may result in serious injury.

Make sure all burners are in their correct locations and fully assembled before attempting to operate any burner.

Select a burner and find its control knob. Push the knob in and turn it to the **LITE** position.

You will hear a clicking noise—the sound of the electric spark igniting the burner. When one burner is turned to **LITE**, all burners will spark. Sparking will continue as long as the knob remains at **LITE**. Once gas is ignited, turn the knob to adjust the flame size.

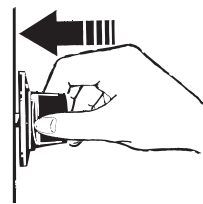

Push the control knob in and turn it to the LITE position.

After Lighting a Burner

- Do not operate the burner for an extended period of time without cookware on the grate. The finish on the grate may discolor or chip without cookware to absorb the heat.
- Do not attempt to disassemble any burner while another burner is on. An electric shock may result, which could cause you to knock over hot cookware.
- Be sure the burners and grates are cool before you place your hand, a pot holder or cleaning materials on them.

Use of the Surface Burners

Your gas rangetop has sealed gas burners. They offer convenience, cleanability and flexibility for a wide range of cooking applications.

The **smallest** burner is the simmer burner. On some models, the center burner of the triple flame burner provides an additional simmer burner. A simmer burner turned down to **LO** provides precise cooking performance

for foods such as delicate sauces that require low heat for a long cooking time.

The **extra-large** burner is designed to quickly bring large amounts of liquid to a boil. Some models have a **POWER BOIL™** setting especially designed for use with cookware with a diameter of 11 inches or larger.

How to Select Flame Size

Watch the flame, not the knob, as you adjust heat. When rapid heating is desired, the flame size on a burner should match the size of the cookware you are using. Flames larger than the bottom of the cookware will not heat faster and may be hazardous.



These flames are too large for the pot

Surface Burners (Cont.)

How to Light the Bridge Burner (on some models)

⚠ WARNING Burner flames not covered by cookware present a risk of fire or clothing ignition. The bridge burner should be used only with the griddle in place. Failure to do so may result in serious injury.

- The front and rear round burners of the bridge burner can be operated individually for cooking. Operation of the bridge burner to heat your Preseasoned Chef's Griddle requires use of both front and rear burner knobs.

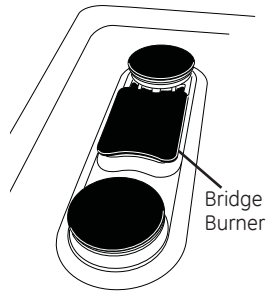

To Light the Bridge Burner:

- Position the griddle over the left grate, observing the 'FRONT' and 'BACK' indications on the griddle.
- Light the rear burner by turning the knob to the **LITE** position. Continue turning the knob to the **Griddle Burner HI** setting to light the bridge burner.
- Light the front burner by turning the knob to the **LITE** position. Once lit, turn the knob further to the **Griddle Burner HI** setting.
- Adjust knob settings and preheat the griddle according to the table for the Preseasoned Chef's Griddle.
- For uniform griddle temperatures, be sure the front and rear knob settings are the same.

Top-of-Range Cookware

Aluminum: Medium-weight cookware is recommended because it heats quickly and evenly. Most foods brown evenly in an aluminum skillet. Use saucepans with tight-fitting lids when cooking with minimum amounts of water.

Stainless Steel: This metal alone has poor heating properties and is usually combined with copper, aluminum or other metals for improved heat distribution. Combination metal skillets usually work satisfactorily if they are used with medium heat as the manufacturer recommends.

Cast-Iron: If heated slowly, most skillets will give satisfactory results.

Enamelware: Under some conditions, the enamel of some cookware may melt. Follow cookware manufacturer's recommendations for cooking methods.

Glass: There are two types of glass cookware—those for oven use only and those for top-of-range cooking (saucepans, coffee and teapots). Glass conducts heat very slowly.

Heatproof Glass Ceramic: Can be used for either surface or oven cooking. It conducts heat very slowly and cools very slowly. Check cookware manufacturer's directions to be sure it can be used on gas ranges.

Stove Top Grills

Do not use an after-market stove top grill on your gas surface burners. A stove top grill will cause incomplete combustion resulting in carbon monoxide levels above allowable standards. This could be hazardous to your health.



Do not use stove top grills

Using a Wok

Use only a flat-bottomed wok with a diameter of 14 inches or less. Make sure the wok bottom sits flat on the grate.

Do not use a wok support ring. Placing the ring over the burner or grate may cause the burner to work improperly, resulting in carbon monoxide levels above allowable standards. This could be hazardous to your health.



Use a flat-bottomed wok.



In Case of a Power Failure

In case of a power failure, you can light the surface burners on your range with a match. Hold a lit match to the burner ports, then slowly turn the control knob to the **LITE** position. Use extreme caution when lighting burners this way.

Surface burners in use when an electrical power failure occurs will continue to operate normally.

Griddle (on some models)

Using the Griddle (on some models)

⚠️ WARNING Fire Hazard

- The **PREHEAT** setting (on some models) is provided to quickly heat your griddle. Turn heat down before placing food on the griddle. Cooking at the **PREHEAT** setting may result in fire.
- Use care when cooking greasy foods. Spilled grease may result in fire.
- Never place any items on the griddle when it is not in use. Heat from surrounding burners can heat the griddle and may result in fire.
- Place and remove the griddle only when griddle is cool and all surface burners are turned **OFF**.

The ribbed side of the reversible griddle (on some models) can be used for food normally grilled.

Your griddle provides an extra-large cooking surface for meats, pancakes and other foods usually prepared in a skillet. Before first use, rinse with hot water and dry thoroughly. Prepare the surface with cooking spray or vegetable oil.

NOTE: Do not place the griddle in a microwave oven.

NOTE: Do not clean the griddle in the self-cleaning oven. Doing so will remove the seasoned finish. For instructions on how to clean the griddle, see Care and Cleaning section.

Placement of the Preseasoned Reversible Cast-Iron Griddle or the Nonstick Aluminum Griddle on the Cooktop

These griddles can only be used over the oval burner in the center of the rangetop. To position the griddle, remove the center grate and replace it with the griddle. Do not turn on the oval burner until you are certain the griddle has been positioned correctly.

Preheating the griddle - Preheat for 5-10 minutes before placing food on griddle and then turn heat down to cook setting.

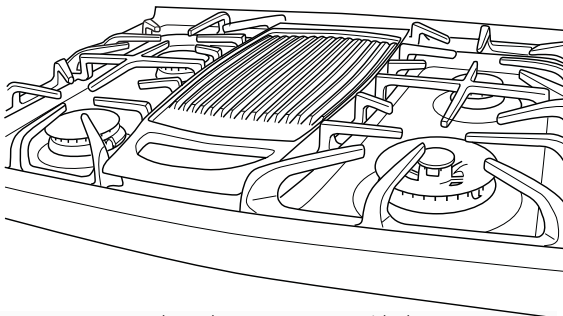

Replace the center grate with the Preseasoned Cast-Iron Reversible Griddle

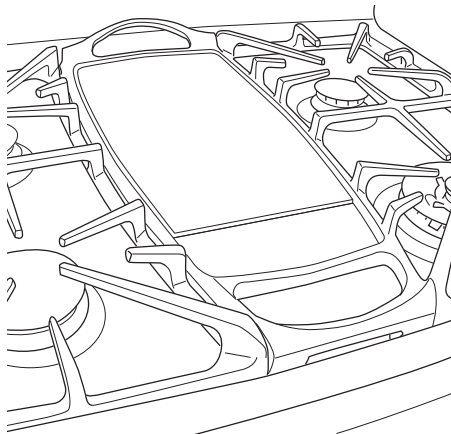

Replace the center grate with the Nonstick Aluminum Griddle

Preseasoned Reversible Cast-Iron Griddle

Type of Food	Cook Setting
Warming Tortillas	Lo
Pancakes	Med-Lo
Hamburgers	Med-Lo
Breakfast Sausage Links	Med
Grilled Cheese	Med-Lo
Bacon	Med
Eggs	Lo

Cook settings may need to be reduced if the griddle is used for an extended time.

Nonstick Aluminum Griddle

Type of Food	Cook Setting
Warming Tortillas	Med-Lo
Pancakes	Med-Lo
Hamburgers	Med
Fried Eggs	Med-Lo
Breakfast Sausage Links	Med
Hot Sandwiches (such as Grilled Cheese)	Med-Lo

Do not overheat the griddle. Leaving the griddle burner on at HI for an extended amount of time without food can damage the nonstick coating.

Avoid using metal utensils with sharp points or rough sharp edges which might damage the griddle surface.

Griddle (on some models) (Cont.)

Using the Griddle (on some models) (Cont.)

Placement of the Preseasoned Lodge Chef's Griddle over Left Grate

The Chef's griddle can only be used resting on top of the left grate. Position the griddle over the left grate observing the "Front" and "Back" indicators stamped in the griddle. The bottom of the griddle should interlock securely with the fingers of the left grate. Do not turn on the bridge burner until you are certain the griddle has been positioned correctly.

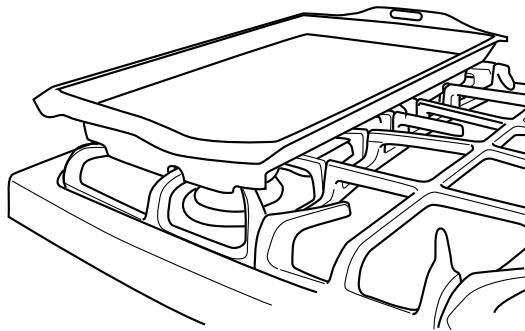

Locate the Preseasoned Lodge Chef's Griddle on top of the left grate

Preseasoned Lodge Chef's Griddle

Type of Food	Cook Setting
Warming Tortillas	Lo
Pancakes	Med
Hamburgers	Med
Breakfast Sausage Links	Med
Hot Sandwiches (such as Grilled Cheese)	Med
Steak	Hi
Veggie Medley	Med
Asparagus	Med
Fish	Med

Cook settings may need to be reduced if the griddle is used for an extended time. Be sure the preheat conditions and cook settings are the same for both the front and rear Griddle Burners.

Oven Controls

Non Convection

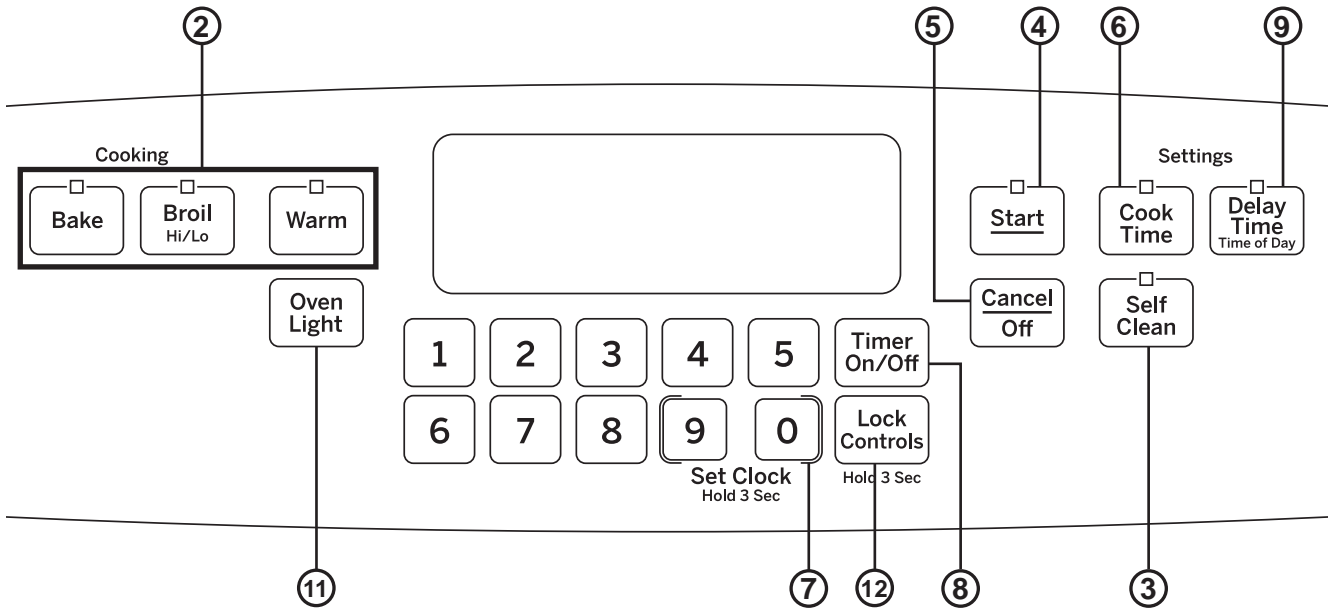

Convection

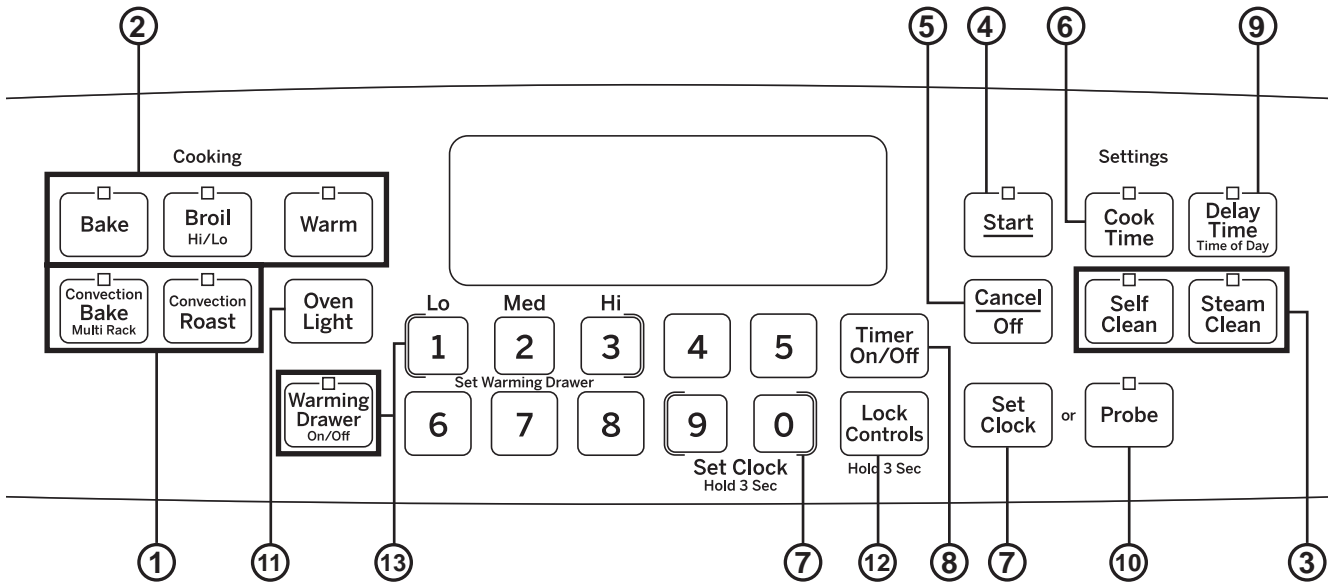

Oven Controls (Cont.)

1. **Convection Cooking Modes:** Convection cooking modes use increased air circulation to improve performance. The type of benefit depends on the mode. Your oven has the following convection cooking modes: Bake Multi Rack and Roast. See the Cooking Modes section for more information.
2. **Traditional Cooking Modes:** Your oven has the following traditional cooking modes: Bake, Broil Hi, Broil Lo and Warm. See the Cooking Modes section for more information.
3. **Clean:** Your oven may have two cleaning modes: Self Clean and Steam Clean (convection models only). See the Cleaning the Oven section for important information about using these modes.
4. **Start:** Must be pressed to start any cooking, cleaning, or timed function.
5. **Cancel/Off:** Cancels ALL oven operations except the clock and timer.
6. **Cook Time:** Counts down cooking time and turns off the oven when the cooking time is complete. Press the **Cook Time** pad, use the number pads to program a cooking time in hours and minutes, then press **Start**. This can only be used with Traditional Bake, Convection Bake, Convection Bake Multi, and Convection Roast.
7. **Clock:** Sets the oven clock time. Press the **9** and **0** pads and hold for 3 seconds or press **Set Clock** pad (on some models). Use the number pads to program the clock. Press **Start** to save the time.
8. **Timer:** Works as a countdown timer. Press the **Timer** pad and the number pads to program the time in hours and minutes. Press the **Start** pad. The oven will continue to operate when the timer countdown is complete. To turn the timer off press the **Timer** pad.
9. **Delay Time:** Delays when the oven will turn on. Use this to set a time when you want the oven to start. Press the **Delay Time** pad and use the number pads to program the time of day for the oven to turn on. Press the desired cooking mode and temperature then press **Start**. A cook time may also be programmed if desired. This can only be used with Traditional Bake, Convection Bake Multi Rack, Convection Roast and Self-Clean.
NOTE: When using the delay time feature, foods that spoil easily—such as milk, eggs, fish, stuffings, poultry and pork—should not be allowed to sit for more than 1 hour before or after cooking. Room temperature promotes the growth of harmful bacteria. Be sure that the oven light is off because heat from the bulb will speed harmful bacteria growth.
10. **Probe:** Monitors internal food temperature and turns the oven off when the food reaches the programmed temperature. Insert the probe, program the cooking mode, and program the probe temperature. See the Cooking Modes section for more information. The probe can only be used with Traditional Bake and Convection Roast.
11. **Oven Light(s):** Turns the oven light(s) on or off.
12. **Lock Controls:** Locks out the control so that pressing the pads does not activate the controls. Press and hold the **Lock Controls** pad for three seconds to lock or unlock the control. **Cancel/Off** is always active, even when the control is locked.
13. **Warming Drawer:** Will keep hot, cooked foods at serving temperature. Press the **Warming Drawer** pad. Use the number pad to select the temperature setting. Press **1** for Low, **2** for Medium or **3** for High, then press **Start**. Push **Warming Drawer** on/off to turn off warming drawer.

Oven Air Vents

Never block the vents (air openings) of the range. They provide the air inlet and outlet that are necessary for the range to keep cool and operate properly with correct combustion.

Air openings are located at the rear of the cooktop, at the top and bottom of the oven door, and at the bottom of the range.

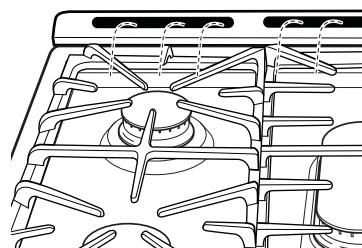
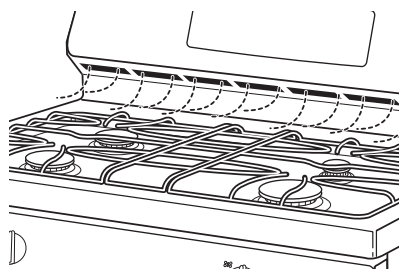

Vent appearance and location vary.

Special Features

There are several different special features on your oven. To change the settings of these special features, press the **Bake** and **Broil** pads at the same time and hold for three seconds. "SF" will appear in the display. Select the feature you want to change. When the change has been made, press the **START** key to save the change and return to the time of day.

Adjust the Oven Temperature

This feature allows the oven baking temperature to be adjusted up to 35°F hotter or down to 35°F cooler. Use this feature if you believe your oven temperature is too hot or too cold and wish to change it.

Press the **Bake** pad to enter the temperature adjustment mode. A number between 35 and - 35 will display. Use the number pads to set the desired temperature adjustment and use the **Bake** pad to change between negative and positive.

Press the **Start** pad to save the temperature adjustment.

End of Timer Signals

This is the tone that signals the end of a timer. The tone can be continuous (Con bEEp) or one repeating beep (bEEp). A continuous setting will continue to sound a tone until a button on the control is pressed. Press the **Broil** pad to view the current setting and then to change the setting.

Fahrenheit or Celsius Temperature Display

The oven control is set to use Fahrenheit temperatures (F), but you can change it to use Celsius temperatures (C). Press the **Broil** and **Cook Time** pads at the same time to view the current setting, press again to change the setting.

Clock Display

This feature specifies how the time of day will be displayed or if no time of day will be displayed. You can select a standard 12-hour clock (12 hr), 24-hour military time display (24 hr), or no clock displayed (OFF). Press the **Clock** pad to view the current setting, press again to change the setting.

Sound Volume

This feature allows the oven tone volume to be adjusted between high (HI bEEP HI), medium (Std bEEP Std), low (Lo bEEP Lo) and off (oFF bEEP oFF). Press the **Cook Time** pad to view the current setting or to change the setting. The control will sound the oven tone at the new volume level each time the sound level is changed.

Autorecipe Conversion

This feature (ON/OFF), automatically adjusts the programmed recipe temperature in Convection Multi-Bake mode.

Note: This option does not convert baking time, only temperatures. This option does not adjust temperatures for Convection Roast mode. Press either **Bake Multi Rack** or **Roast** to view the current setting. Press again to change the setting.

12-hour auto shut-off and Sabbath

12-hour auto shut-off turns off the oven after 12 hours of continuous operations.

Options for this feature are "12 Shdn", "no Shdn" and "SAbbAtH". Press the **Delay Time** pad to view the current setting and then to change the setting.

Sabbath mode disables the oven lights, all sounds, convection, broil, warm, proof, and all time functions. Sabbath mode can only be used with Bake. This feature conforms to the Star-K Jewish Sabbath requirements.

After selecting the "SAbbAtH" mode and pressing **Start**, a **J** will appear in the display and the clock will not display. At any time you can press **Bake**, use the number pads to enter a temperature between 170F and 550F, and press **Start**. No sound will be given when the keys are pressed. At a random time between 30 seconds and 1 minute, **||** will appear in the display indicating the oven is running. To turn the oven off, press **Cancel/Off** at any time. At a random time between 30 seconds and 1 minute, **||** will change to **J** indicating that the oven has turned off. If you need to adjust the temperature it is recommended that you turn off the oven, confirm that the oven has turned off, and then follow the information above to program the new temperature. This will help ensure that the new temperature has been programmed.

To exit Sabbath mode, follow the procedure in the Special Features section and press **Delay Time** until either "12 Shdn" or "no Shdn" is in the display and press **Start**.

Note: If power outage occurs during Sabbath mode the unit will remain in Sabbath mode when power is restored.

Oven Racks and Rack Positions

Your oven has six rack positions. Recommended rack positions for various types of foods are provided in the Cooking Guide. Adjusting rack position is one way to impact cooking results. For example, if you would prefer darker tops on cakes, muffins, or cookies, try moving food one rack position higher. If you find foods are too brown on top try moving them down next time.

When baking with multiple pans and on multiple racks, ensure there is sufficient space between pans to allow air to flow.

Flat Racks

When placing and removing cookware, pull the rack out to the bump (stop position) on the rack support.

To remove a rack, pull it toward you, tilt the front end up and pull it out.

To replace, place the curved end of the rack (stop-locks) onto the oven supports, tilt up the front of the rack and push the rack in.

Racks may become difficult to slide, especially after a self-clean. Put some vegetable oil on a soft cloth or paper towel and rub onto the left and right edges.

Extension Racks (on some models)

Extension racks have a frame that locks into the rack supports on both sides. Once the frame is locked into place, always pull the rack out, by its upper front rail, to its full extension stop position, when placing or removing cookware.

If extension racks are difficult to extend, lubricate the racks with the graphite lubricant provided with your oven. Remove the rack from the oven, remove debris in the slide tracks with a paper towel, shake the graphite lubricant and place 4 small drops on the two bottom tracks of the left and right sides. Open and close the rack several times to distribute the lubricant.

To order additional graphite lubricant, read the Assistance and Accessories section at the beginning of this manual.

To Remove An Extension Rack:

1. Make sure the rack is pushed all the way into the oven.
2. Firmly holding onto both the upper and lower front rails, pull the rack toward you, tilt the front end up and pull the rack out

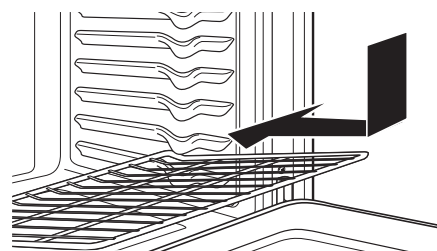
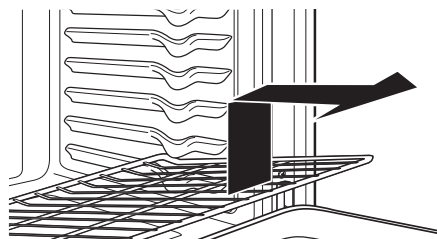
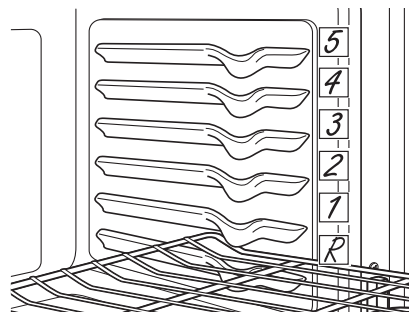

To Replace An Extension Rack:

1. Place the curved end of the rack onto the rack supports
2. Tilt the front of the rack up and push the rack in.

If extension racks are difficult to replace or remove, wipe the oven rack supports with cooking oil. Do not wipe oil on the rack slides.

Cooking Modes

Your new oven has a variety of cooking modes to help you get the best results. These modes are described below. Refer to the Cooking Guide section for recommendations for specific foods. Remember, your new oven may perform differently than the oven it is replacing.

Bake

The bake mode is for baking and roasting. This mode uses heat primarily from the lower burner but also from the upper burner to cook food. When preparing baked goods such as cakes, cookies, and pastries always preheat the oven first. Follow recipe recommendations for food placement. If no guidelines are provided center food in the oven. To use this mode press the Bake pad, enter a temperature, and then press Start.

Warm/Warming Drawer (on some models)

Warm mode is designed to keep hot foods hot for up to 3 hours. To use this mode, press the **Warm** or **Warming Drawer** pad then press **Start**. Cover foods that need to remain moist and do not cover foods that should be crisp. Preheating is not required. Do not use warm to heat cold food other than crisping crackers, chips or dry cereal. It is also recommended that food not be kept warm for more than 2 hours.

Broiling Modes

Always broil with the door closed. Monitor food closely while broiling. Use caution when broiling on upper rack positions as placing food closer to the broil burner increases smoking, spattering, and the possibility of fats igniting. **Broiling on rack position 5 is not recommended.**

Try broiling foods that you would normally grill. Adjust rack positions to adjust the intensity of the heat to the food. Place foods closer to the broil burner when a seared surface and rare interior is desired. Thicker foods and foods that need to be cooked through should be broiled on a rack position farther from the burner or by using Broil Lo.

Broil Hi

The Broil Hi mode uses intense heat from the upper burner to sear foods. Use Broil Hi for thinner cuts of meat and/ or foods you prefer less done on the interior. To use this mode press the **Broil** pad once and then press **Start**. It is not necessary to preheat when using this mode.

Broil Lo

The Broil Lo mode uses less intense heat from the upper burner to cook food thoroughly while also browning the surface. Use Broil Lo for thicker cuts of meat and/or foods that you would like cooked all the way through. To use this mode press the **Broil** pad **twice** and then press **Start**. It is not necessary to preheat when using this mode.

Convection Bake Multi Rack

The Convection Bake Multi Rack mode is intended for baking on multiple racks at the same time. This mode may use heat from the upper and lower burners, along with air movement from the convection fan to enhance cooking evenness. Your oven is equipped with Auto Recipe Conversion, so it is not necessary to convert the temperature when using this mode. To use this mode press the **Bake Multi Rack** pad under **Convection**, enter a temperature, and then press **Start**. Always preheat when using this mode.

Convection Roast

The Convection Roast mode is intended for roasting whole cuts of meat on a single rack. This mode may use heat from the upper and lower bake burner along with air movement to improve browning and reduce cooking time. It is not necessary to convert temperature. Check food earlier than the recipe suggested time when using this mode, or use the probe (on some models). To use this mode press the **Roast** pad under **Convection**, enter a temperature, and then press **Start**. It is not necessary to preheat when using this mode.

Probe

Internal food temperature is frequently used as an indicator of doneness, especially for roasts and poultry. The Probe mode monitors the internal food temperature and turns the oven off when the internal food temperature reaches the programmed temperature. Minimum temperatures for food safety can be found at www.IsItDoneYet.gov. The temperature probe can only be used with Traditional Bake, Convection Bake, and Convection Roast modes.

To use the probe with preheating:

1. Press the desired cook mode (**Traditional Bake, Convection Bake, or Convection Roast**) pad and enter the desired cooking temperature.
2. Insert the probe into the food (see Proper Probe Placement Guidelines in this section).
3. Once the oven is preheated, place the food in the oven and connect the probe to the probe outlet, making sure it is fully inserted. Use caution, the oven walls and probe outlet are hot.
4. Program the probe temperature by pressing the **Probe** pad and entering the desired food temperature. The maximum internal food temperature that you can set is 200° F.

Cooking Modes (Cont.)

To use the probe without preheating:

1. Insert the probe into the food (see Proper Probe Placement Guidelines in this section).
2. Place the food in the oven and connect the probe into the probe outlet in the oven.
3. Program the desired probe and cooking mode settings by pressing the **Probe** pad and entering the desired food temperature, then pressing the cook mode pad (**Traditional Bake**, **Convection Bake**, or **Convection Roast**) and entering the desired cooking temperature.

Proper Probe Placement Guidelines

After preparing the meat and placing it on the cooking pan follow these guidelines for proper probe placement.

- Insert the probe completely into the meat, up to the handle, such that the point of the probe will rest in the center of the thickest part of the meat.
- The probe should not touch bone, fat or gristle.
- For whole poultry insert the probe into the thickest part of the breast.
- For boneless roasts, insert the probe into the center of the roast.
- For bone-in ham or lamb, insert the probe into the center of the lowest large muscle or joint.

- For casseroles or dishes such as meatloaf, insert the probe into the center of the dish.
- For fish, insert the probe from just above the gill into the meatiest area, parallel to the backbone.

Check the temperature at other locations in the food with a food thermometer once the probe temperature is reached to ensure that all portions of the food have reached desired temperatures.

Probe Care Guidelines

NOTE: some double oven models have a probe in the upper oven only.

- Use of probes other than the one provided with this product may result in damage to the probe.
- Use the handles of the probe and plug when inserting and removing them from the meat and outlet
- To avoid damaging your probe, do not use tongs to pull on the cable when removing it.
- To avoid breaking the probe, make sure food is completely defrosted before inserting the probe.
- To prevent possible burns, do not unplug the probe from the outlet until the oven has cooled.
- Never leave the probe inside the oven during a self or steam clean cycle.
- Do not store the probe in the oven.

Cookware

Cookware Guidelines

The material, finish, and size of cookware affect baking performance.

Dark, coated and dull pans absorb heat more readily than light, shiny pans. Pans that absorb heat more readily can result in a browner, crisper, and thicker crust. If using dark and coated cookware check food earlier than minimum cook time. If undesirable results are obtained with this type of cookware consider reducing oven temperature by 25° F next time.

Shiny pans can produce more evenly cooked baked goods such as cakes and cookies.

Glass and ceramic pans heat slowly but retain heat well. These types of pans work well for dishes such as pies and custards.

Air insulated pans heat slowly and can reduce bottom browning.

Keep cookware clean to promote even heating.

Cooking Guide

FOOD TYPE	RECOMMENDED MODE(S)	RECOMMENDED RACK POSITION(S)	ADDITIONAL SUGGESTIONS
Baked Goods			
Layer cakes, sheet cakes, bundt cakes, muffins, quick breads, biscuits, scones on a Single Rack	Bake	2 or 3	Use shiny cookware.
Layer cakes* on Multiple Racks	Bake Convection Multi-Bake	2 and 4	Ensure adequate airflow (see illustration below). Use extension rack in positions 2.
Chiffon cakes (angel food)	Bake	1	Use shiny cookware.
Cookies, biscuits, scones on a Single Rack	Bake	2 or 3	Use shiny cookware.
Cookies, biscuits, scones on Multiple Racks	Convection Multi-Bake Bake	2 Racks - 2 and 4 3 Racks - 1, 3 and 5	Ensure adequate airflow. Switch food location partially through cooking for more even cooking results. Use extension rack in lower position.
Beef & Pork			
Hamburgers	Broil Hi	5	Use flat rack. Use a broil pan; move food down for more doneness/less searing. Watch food closely when broiling. Center food under burner.
Steaks & Chops	Broil Hi	5	Use flat rack. Use a broil pan; move food down for more doneness/less searing. Watch food closely when broiling. Center food under burner.
Roasts	Convection Roast Bake	1 or 2	Leave uncovered, use a low sided pan such as a broil pan. Preheating is not necessary.
Poultry			
Whole chicken	Convection Roast Bake	1 or 2	Leave uncovered, use a low sided pan such as a broil pan.
Bone-in chicken breasts, legs, thighs	Broil Lo Bake	2 or 3	If breaded or coated in sauce avoid Broil Hi modes. Broil skin side down first. Watch food closely when broiling.
Boneless chicken breasts	Broil Lo Bake	3	Move food down for more doneness/less searing and up for greater searing/browning when broiling.
Whole turkey	Convection Roast Bake	R or 1	Leave uncovered, use a low sided pan such as a broil pan.
Turkey Breast	Bake	1 or 2	Leave uncovered, use a low sided pan such as a broil pan.
Fish	Broil Lo	5 (1/2 thick or less) 4 (>1/2 inch)	Watch food closely when broiling. Use flat rack if using position 5
Casseroles	Bake	2 or 3	
Frozen Convenience Foods			
Pizza, french fries, tator tots, chicken nuggets, appetizers on a Single Rack	Bake	3	Use shiny cookware.
Pizza, french fries, tator tots, chicken nuggets, appetizers on Multiple Racks	Bake Convection Multi-Bake	2 and 4 1, 3 and 5	Use shiny cookware. Switch food location partially through cooking for more even cooking results.

*When baking four cake layers at a time, stagger the pans as shown so that one pan is not directly above another.

Cook food thoroughly to help protect against food borne illness. Minimum safe food temperature recommendations for food safety can be found at www.IsItDoneYet.gov. Make sure to use a food thermometer to take food temperatures.

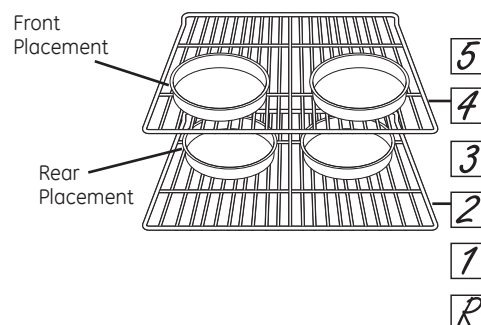

Warming Drawer Guide (on some models)

ITEM	SETTING	ADDITIONAL INFORMATION
Breads, pies, pastries	LO (1)	Cover with a lid or aluminum foil. Vent cover to allow moisture to escape.
Casseroles	MED (2)	Cover with a lid or aluminum foil
Chili/Stews	HI (3)	
Meats	HI (3)	
Pancakes	LO (1)	
Pizza	MED (2)	
Potatoes, baked	HI (3)	
Waffles	LO (1)	
Stale items, to crisp (tortilla chips, crackers, dry cereal)	LO (1)	Use a low sided dish/pan. Preheat on LO setting 5-10 minutes. Check after 45 minutes, add time as needed
Serving dishes (plates, bowls)	LO (1)	Use only heat safe dishes. Check manufacturers information for maximum heat tolerance for fine china.

⚠ CAUTION Dishes will be hot. Use pot holders or mitts when removing hot dishes.

Aluminum Foil

Do not use aluminum foil to line oven bottoms. The foil will trap heat below and upset the performance of the oven. Foil can melt and permanently damage the oven bottom. Damage from improper use of aluminum foil is not covered by the product warranty.

Foil may be used to catch spills by placing a sheet on a lower rack, several inches below the food. Do not use more foil than necessary and never entirely cover an oven rack with aluminum foil. Keep foil at least 1-1/2" from oven walls to prevent poor heat circulation.

Cleaning The Oven

Be sure electrical power is off and all surfaces are cool before cleaning any part of the oven.

Control Panel and Knobs

Wipe the control panel after each use of the oven with a damp cloth. For cleaning, use mild soap and water or a 50/50 solution of vinegar and water. Rinse with clean water. Polish dry with a soft cloth.

Do not use abrasive cleansers, strong liquid cleansers, plastic scouring pads or oven cleaners on the control panel—they will damage the finish.

Do not try to bend knobs by pulling them up or down or by hanging a towel or other such loads. This can damage the gas valve shaft.

The control knobs may be removed for easier cleaning.

With knobs in the **OFF** position pull them straight off the stems.

The knobs can be washed by hand with soap and water or in a dishwasher.

Not all knobs are interchangeable. To determine the correct location of a particular knob, examine the back of the knob. A knob with a label or two stem holes should be replaced on the front panel first by matching the shape of the knob holes to the shape of the control panel stems. The remainder of the knobs having no labels and only one stem hole can then be replaced on the front panel anywhere there is a single stem.

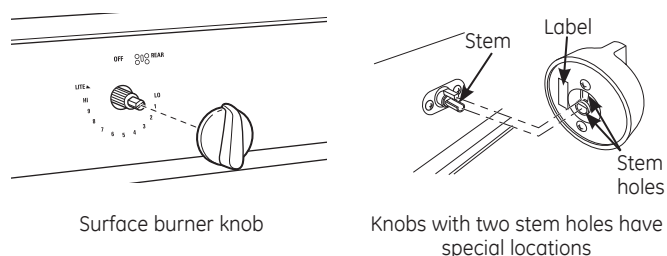

Oven Exterior and Cooktop Surface

Do not use oven cleaners, abrasive cleansers, strong liquid cleansers, steel wool, plastic scouring pads, or cleaning powders on the interior or exterior of the oven. Clean with a mild soap and water or a 50/50 solution of vinegar and water. Rinse with clean water and dry with a soft cloth. When cleaning surfaces, make sure that they are at room temperature and not in direct sunlight.

If a stain on the door vent trim is persistent, use a mild abrasive cleaner and a sponge-scrubber for best results.

Spillage of marinades, fruit juices, tomato sauces and basting liquids containing acids may cause discoloration and should be wiped up immediately. Let hot surfaces cool, then clean and rinse.

Stainless Steel Surfaces (on some models)

Do not use a steel wool pad; it will scratch the surface.

To clean the stainless steel surface, use warm sudsy water or a stainless steel cleaner or polish. Always wipe the surface in the direction of the grain. Follow the cleaner instructions for cleaning the stainless steel surface.

To inquire about purchasing cleaning products including stainless steel appliance cleaner or polish read the Assistance and Accessories sections at the beginning of this manual.

Oven Interior

The interior of your new oven can be cleaned manually or by using the Steam Clean or Self Clean modes.

Spillage of marinades, fruit juices, tomato sauces and basting liquids containing acids may cause discoloration and should be wiped up as soon as hot surfaces cool, then clean and rinse.

Manual Cleaning

Do not use oven cleaners, abrasive cleaners, strong liquid cleansers, steel wool, scouring pads, or cleaning powders on the interior of the oven. Clean with a mild soap and water or 50/50 solution of vinegar and water. Rinse with clean water and dry with a soft cloth. When cleaning surfaces, make sure that they are at room temperature and not in direct sunlight.

Steam Clean Mode (on some models)

The Steam Clean feature is intended to use water to clean light soil from your oven at a lower temperature than Self Clean.

To use the Steam Clean feature:

1. Start with the oven at room temperature
2. Wipe excess grease and soils from the oven
3. Pour one cup of water onto the bottom of the oven
4. Close the door
5. Press the Steam Clean pad and then press Start.

The oven door will lock. You cannot open the door during the 12 minute Steam Clean cycle as this will decrease the cleaning performance. At the end of the Steam Clean cycle the door will unlock. With a sponge, soak up remaining water and wipe the moisture-softened soil from the oven walls and door.

Cleaning The Oven (Cont.)

Oven Interior (continued)

Self Clean Mode

Read Self-Cleaning Oven Safety Instructions at the beginning of this manual before using Self Clean Mode. Self clean uses very high temperatures to clean the oven interior. The oven door will lock when using this feature. Before operating the self-clean cycle, pre-wash inner door and inside window before self-cleaning. Wipe inner black door before self clean. Remove all items from the oven other than enameled (dark color) racks. Shiny or silver racks, the meat probe, and any cookware or other items should all be removed from the oven before

initiating a self-clean cycle. The surface burners must be turned off prior to the self-clean start time. Cooktop burners will not start during self clean cycle. Close the door. Press the **Clean** pad once and a default self-clean time is displayed. Press the **START** pad or use the number pads to enter any clean time between 3 and 5 hours and press start. For heavily soiled ovens 5 hours is recommended. The oven will turn off automatically when the self-clean cycle is complete. The door will stay locked until the oven has cooled down. After the oven has cooled down wipe any ash out of the oven.

Oven Racks

All oven racks may be cleaned by hand with an abrasive cleaner or steel wool. Black porcelain-coated oven racks may remain in the oven during the self-cleaning cycle without being damaged. If nickel-plated oven racks remain in the oven during the self-cleaning cycle, they

will lose their luster and become hard to slide. It will be necessary to grease all oven rack side edges with a light coating of vegetable oil after cleaning them by hand or in the oven. This will help maintain the ease of sliding the racks in and out of the oven.

Probe

The temperature probe may be cleaned with soap and water or a soap-filled scouring pad. Cool the temperature probe before cleaning. Scour stubborn spots with a soap-filled scouring pad, rinse and dry.

To order additional temperature probes read the Assistance and Accessories sections at the beginning of this manual.

- Do not immerse the temperature probe in water.
- Do not store the temperature probe in the oven.
- Do not leave the temperature probe inside the oven during a self or steam clean cycle.

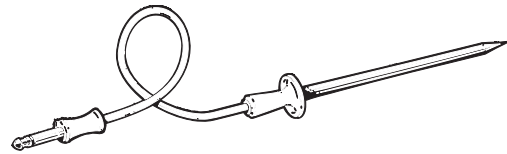

Cleaning The Cooktop

Removal of Surface Burners for Cleaning

Turn all controls **OFF**. Allow cooktop to cool before removing grates and burner parts. When removing the burner caps and heads, remember their size and location. Replace them in the same location after cleaning.

CAUTION Do not attempt to remove bridge burner, oval burner or tri-ring burner caps from burner heads.

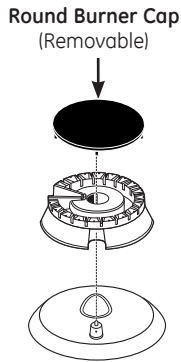

Round Burner
The burner caps and burner heads can be lifted off the cooktop.

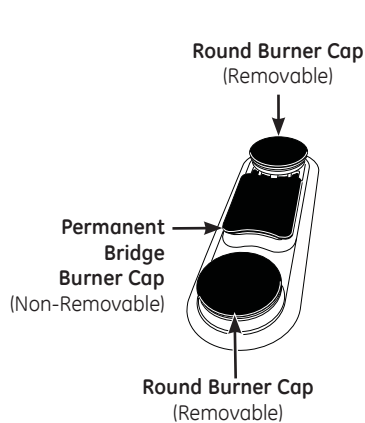

Bridge Burner (on some models)
The bridge burner cap is permanently attached to the burner head assembly. The burner assembly can be lifted off the cooktop as one piece. The burner caps and burner heads can be lifted off the cooktop.

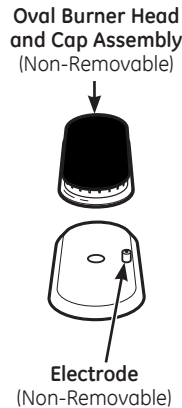

Oval Burner (on some models)
Cap is permanently attached to the burner head.

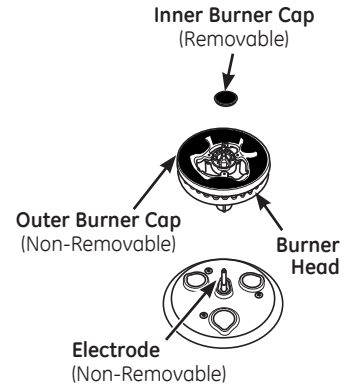

Tri-Ring Burner (on some models)
The small tri-ring burner cap can be lifted off for cleaning. The outer cap is permanently attached to the burner head assembly. Lift the burner head assembly off the cooktop as one piece.

Cleaning The Cooktop (Cont.)

Cleaning The Burners

Burner Caps

Wash burner caps in hot, soapy water and rinse with clean water. You may scour with a plastic scouring pad to remove burned-on food particles. The round caps may also be cleaned in your dishwasher.

Burner Heads

Wash the burner heads routinely, especially after bad spillovers, which could clog the openings. Lift burners off when cool. Use hot, soapy water. Rinse with clean water. For more stubborn stains, use a brush with plastic bristles.

NOTE: Do not use steel wool or scouring powders to clean the burner parts as these may clog the parts. Never wash burner heads in your dishwasher as dishwasher detergents will discolor your burners.

The ports in the burner heads must be kept clean at all times for an even, unhampered flame.

Clogged or dirty burner ports or electrodes will not allow the burner to operate properly.

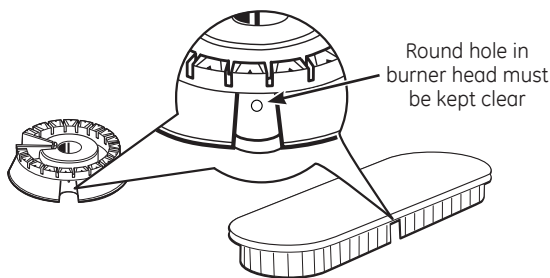

For proper ignition, make sure the small hole in the notch that fits over the electrode is kept open. A sewing needle or wire twist-tie works well to unclog it

After cleaning

Before putting the burner caps, heads (on some models) and oval head/cap assembly back, shake out excess water and allow them to dry thoroughly.

Replacing Burner Heads

Replace burner heads in the correct locations according to size.

Burner Caps

Replace burner caps on burner heads. Make sure each cap fits securely and sits flat on its corresponding burner head.

CAUTION Do not operate the cooktop without all burner parts and grates in place.

Any spill on or around an electrode must be carefully cleaned. Take care to not hit an electrode with anything hard or it could be damaged.

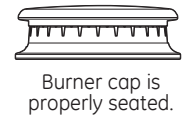
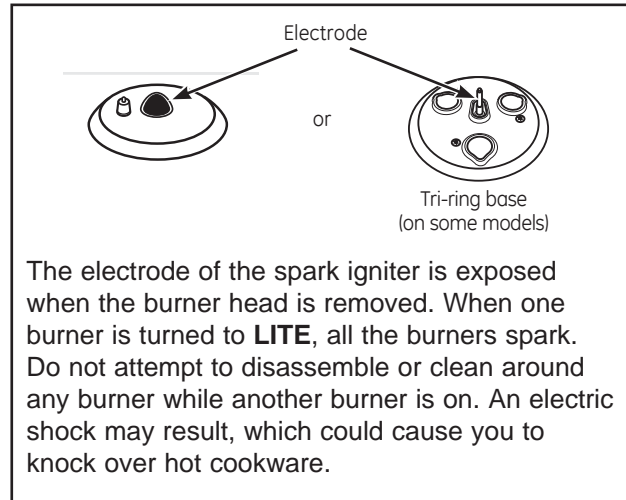

Cleaning The Cooktop (Cont.)

Burner Grates

Grates should be washed in hot, soapy water and rinsed with clean water. To soften burned-on food, place grates in a plastic bag containing ¼-cup of household ammonia for several hours. Afterward, scrub grates with a plastic scouring pad soaked in hot, soapy water. Rinse well and dry.

When replacing the grates, be sure to locate them correctly on the cooktop. Grates are identified by the words **LEFT** and **RIGHT** on their bottom surfaces. Grate should fit securely into the cooktop.

Grates will gradually lose their shine due to their continual exposure to high temperatures.

Cleaning the Grates in the Self-Clean Oven (on some models)

If your cooktop grates do **not** have rubber bumpers on their bottom surface **and** your oven racks are coated with black porcelain, your grates may be cleaned in the oven using the self-clean cycle. If your grates have rubber bumpers, do not attempt to clean your grates in the oven. Doing so will destroy the rubber bumpers and may affect the function of your surface burners.

Place oven racks in the positions labeled "R", "2" and "4" in the illustration. Place a single grate on each rack. Follow instructions for the self-clean mode in the **Cleaning the Oven** section of this manual.

NOTE: Use caution when removing the grates from the oven after the self-clean cycle has ended. The grates may still be hot.

After cleaning, you may notice a white residue on the grates. Wipe it off with a damp sponge. If white spots persist, wet the sponge with a 50/50 solution of vinegar and water.

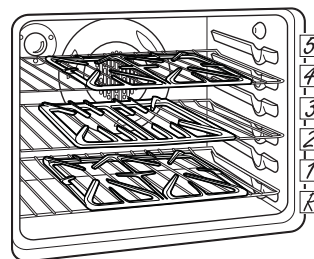

The oven has 6 rack positions. Place the gray porcelain-coated racks in positions "R", "2" and "4" for self-cleaning the grates.

Grate Support Bumpers

If any of the rubber grate support bumpers in the cooktop are missing or damaged, replacement parts can be obtained by calling 1.800.GE.CARES.

To insert the new bumpers, simply place the cone-shaped end of the bumper into the hole in the cooktop and push down while gently twisting the bumper.

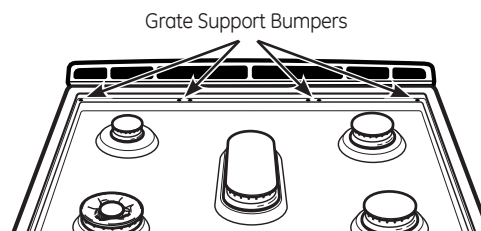

Griddles (on some models)

Non-Stick Aluminum Griddle: Avoid scraping the griddle surface with metal utensils. Wash your griddle with dish detergent and hot water. If necessary, scrub with a non-abrasive plastic pad.

Cast-Iron Reversible or Chef's Griddle: clean your cast-iron reversible or chef's griddle with a stiff brush and hot water. Using soap is not recommended, and harsh detergents should never be used as they will remove the seasoning. Rinse with hot water and dry thoroughly. Apply a light coat of cooking oil to the griddle surface. Wipe off excess oil with a paper towel.

Store in a cool, dry place.

Griddle Precautions:

If something has spilled under the griddle, it should be cleaned up as soon as possible to prevent the spill from getting baked onto the cooktop.

Do not allow grease to accumulate under the griddle as it can be a fire hazard. Clean under the griddle with hot soapy water as soon as it is cool.

Do not wash your griddle in the dishwasher.

Do not place your griddle in a microwave oven.

Cleaning The Door and Drawer

To clean the inside of the door

Do not allow excess water to run into any holes or slots in the door.

Wipe dishwashing detergent over any baked-on spatters on the glass. Use a single sided safety razor blade to clean it off. Then wipe over the glass with a soapy cloth to remove any residue and dry off.

The area outside the gasket can be cleaned with a soap-filled plastic scouring pad.

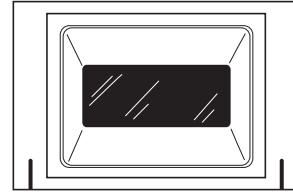

The gasket is designed with a gap at the bottom to allow for proper air circulation.

Do not rub or clean the door gasket—it has an extremely low resistance to abrasion.

If you notice the gasket becoming worn, frayed or damaged in any way or if it has become displaced on the door, you should have it replaced.

Removable Storage Drawer (on some models)

The storage drawer is a good place to store cookware and bakeware. Do not store plastics and flammable material in the drawer.

The storage drawer may be removed for cleaning under the range. Clean the storage drawer with a damp cloth or sponge. Never use harsh abrasives or scouring pads.

To remove storage drawer:

1. Pull drawer straight out until it stops.
2. Tilt the front of the drawer up and free of the range.

To replace storage drawer:

1. Set the stops on the back of the drawer over the stops in the range.
2. Slide drawer evenly and straight back, so that the rails

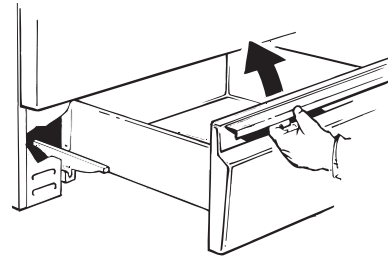

The storage drawer may be removed for cleaning under the range.

Removable Drawer (Warming Drawer Models only)

NOTE: For models with an electric warming drawer, before performing any adjustments, cleaning or service, disconnect the range electrical power supply at the household distribution panel by removing the fuse or switching off the circuit breaker. Make sure the warming drawer heating element is cool.

Most cleaning can be done with the drawer in place. However, the drawer may be removed if further cleaning is needed. Use soap and warm water to thoroughly clean.

To remove the drawer:

1. Pull drawer straight out until it stops.
2. Press the left rail release up and press the right rail release down, while pulling the drawer forward and free.

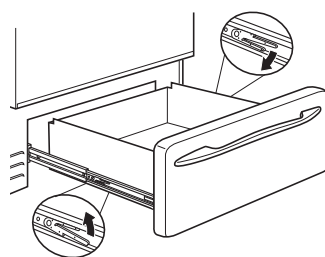

To replace the drawer:

1. Place the left drawer rail around the inner left rail guide and slide it in slightly to hook it.
2. Place the right drawer rail around the inner right rail guide and slide it in slightly to hook it.
3. Slide the drawer all the way in.

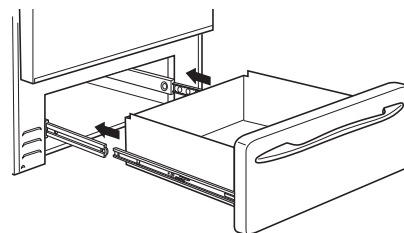

Maintenance

Oven Light Replacement



SHOCK OR BURN HAZARD: Before replacing oven light bulb, disconnect the electrical power to the oven at the main fuse or circuit breaker panel. Failure to do so may result in electric shock or burn.



BURN HAZARD: The glass cover and bulb should be removed when cool. Touching hot glass with bare hands or a damp cloth can cause burns.

Oven Light Bulb

NOTE: The glass cover should be removed only when cold. Wearing latex gloves may offer a better grip.

Before replacing the bulb, disconnect electrical power to the oven at the main fuse or circuit breaker panel. Let the bulb cool completely before removing it. For your safety do not touch a hot bulb with a damp cloth. If you do the bulb may break.

To remove:

Turn the glass cover counterclockwise 1/4 turn until the tabs of the glass cover clear the grooves of the socket. Remove the bulb.

To replace:

Put in a new 40-watt appliance bulb. Place the tabs of the glass cover into the grooves of the socket. Turn the glass cover clockwise 1/4 turn.

NOTE:

- A 40-watt appliance bulb is smaller than a standard 40-watt household bulb.
- Reconnect electrical power to the oven once the new bulb is installed.
- For improved lighting inside the oven, clean the glass cover frequently using a wet cloth. This should be done when the oven is completely cool.

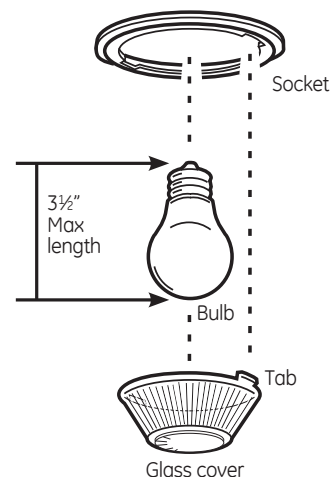

Lift-Off Oven Door

The door is very heavy. Be careful when removing and lifting the door. Do not lift door by the handle.

To Remove the Door:

1. Fully open the door.
2. Pull the hinge locks up and away from the range frame to the unlocked position.
3. Firmly grasp both sides of the door near the top.
4. Close door until the top of the door is approximately 6" from the range frame.
5. Lift door up and away from the range until both hinge arms are clear of the slots in the range frame.

4. Push the hinge locks toward the range cavity and down to the locked position.
5. Close the oven door.

To Replace the Door:

1. Firmly grasp both sides of the door near the top.
2. With the door at the same angle as the removal position, rest the notch on the underside of the left hinge arm on the bottom edge of the left hinge slot. The notch in the hinge arm must be fully seated into the bottom of the slot. Repeat for the right side.
3. Fully open the door. If the door will not fully open, the notches in the bottoms of the hinge arms have not seated correctly in the bottom edge of the slot. Lift the door off the range and repeat previous step.

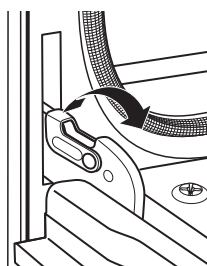

Pull hinge locks up to unlock

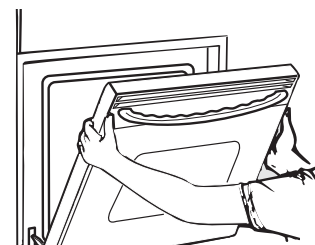

Removal position

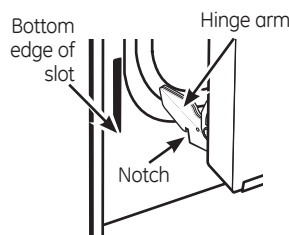

Rest notch on bottom edge of hinge slot

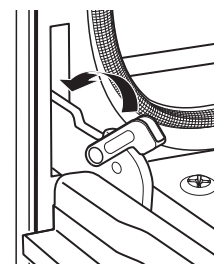

Push hinge locks down to lock

Troubleshooting tips ... Before you call for service

Save time and money! Review the charts on the following pages first and you may not need to call for service.

Problem	Possible Cause	What To Do
My new oven doesn't cook like my old one. Is something wrong with the temperature settings?	Your new oven has a different cooking system from your old oven and therefore may cook differently than your old oven.	For the first few uses, follow your recipe times and temperatures carefully. If you still think your new oven is too hot or too cold, you can adjust the temperature yourself to meet your specific cooking preference.
Food does not bake properly	Oven controls improperly set.	See the Cooking Modes section.
	Rack position is incorrect or rack is not level.	See the Cooking Modes section and Cooking Guide.
	Incorrect cookware or cookware of improper size being used.	See the Cookware section.
	Oven temperature needs adjustment.	See the Special Features section.
	Ingredient substitution	Substituting ingredients can change the recipe outcome.
Food does not broil properly	Oven controls improperly set.	Make sure you select the appropriate broil mode.
	Improper rack position being used.	See Cooking Guide for rack location suggestions.
	Food being cooked in a hot pan.	Make sure cookware is cool.
	Cookware not suited for broiling.	Use a pan specifically designed for broiling.
	Aluminum foil used on the broiling pan and grid has not been fitted properly and slit as recommended.	If using aluminum foil conform to pan slits.
	In some areas the power (voltage) may be low.	Preheat the broil element for 10 minutes.
Oven temperature too hot or too cold	Oven temperature needs adjustment.	See the Special Features section.
Oven does not work or appears not to work	A fuse in your home may be blown or the circuit breaker tripped.	Replace the fuse or reset the circuit breaker.
	Oven controls improperly set.	See the Using the Oven section.
	Oven is in Sabbath Mode.	Verify, that the oven is not in Sabbath Mode. See the Special Features section.
"Crackling" or "popping" sound	This is the sound of the metal heating and cooling during both the cooking and cleaning functions.	This is normal.
Why is my range making a "clicking" noise when using my oven?	Your range has been designed to maintain a tighter control over your oven's temperature. You may hear your oven's heating elements "click" on and off more frequently than in older ovens to achieve better results during baking, broiling, and self-clean cycles.	This is normal.
Clock and timer do not work	A fuse in your home may be blown or the circuit breaker tripped.	Replace the fuse or reset the circuit breaker.
Sometimes the oven takes longer to preheat to the same temperature	Cookware or food in oven	The cookware or food in the oven will cause the oven to take longer to preheat. Remove items to reduce preheat time.
	Number of racks in oven	Adding more racks to the oven will cause the oven to take longer to preheat. Remove some racks.

Troubleshooting tips ... Before you call for service

Problem	Possible Cause	What To Do
Oven light does not work	Light bulb is loose or defective.	Tighten or replace bulb.
	Pad operating light is broken.	Call for service.
Oven will not self-clean	The temperature is too high to set a self-clean operation.	Allow the oven to cool and reset the controls.
	Oven controls improperly set.	See the Cleaning the Oven section.
Excessive smoking during clean cycle	Excessive soil or grease..	Press the Cancel/Off pad. Open the windows to rid the room of smoke. Wait until the LOCKED light goes off. Wipe up the excess soil and reset the clean cycle.
Excessive smoking during broiling	Food too close to burner element.	Lower the rack position of the food.
Oven door will not open after a clean cycle	Oven too hot.	Allow the oven to cool below locking temperature.
Oven not clean after a clean cycle	Oven controls improperly set.	See the Cleaning the Oven section.
	Oven was heavily soiled.	Clean up heavy spillovers before starting the clean cycle. Heavily soiled ovens may need to self-clean again or for a longer period of time.
"DOOR (and a lock symbol)" flashes in the display	The self-clean cycle has been selected but the door is not closed.	Close the oven door.
LOCKED light is on when you want to cook	The oven door is locked because the temperature inside the oven has not dropped below the locking temperature.	Press the Cancel/Off pad. Allow the oven to cool.
"F— and a number or letter" flash in the display	You have a function error code.	Press the Cancel/Off pad. Allow the oven to cool for one hour. Put the oven back into operation.
	If the function code repeats.	Disconnect all power to the oven for at least 30 seconds and then reconnect power. If the function error code repeats, call for service.
Display goes blank	A fuse in your home may be blown or the circuit breaker tripped.	Replace the fuse or reset the circuit breaker.
	The clock is turned off.	See the Special features section.
	Oven is in Sabbath Mode.	Verify that the oven is not in Sabbath Mode. See the Special Features section.
Power outage, clock flashes	Power outage or surge	Reset the clock. If the oven was in use, you must reset it by pressing the Cancel/Off pad, setting the clock and resetting any cooking function.
"Burning" or "oily" odor emitting from the vent	This is normal in a new oven and will disappear in time.	To speed the process, set a self-clean cycle for a minimum of 3 hours. See the Cleaning the Oven section. This is temporary.
Strong odor	An odor from the oven insulation is normal for the first few times the oven is used.	This is temporary and will go away after several uses or a self-clean cycle.
My oven door glass appears to be "tinted" or have a "rainbow" color. Is this defective?	No. The inner oven glass is coated with a heat barrier to reflect the heat back into the oven to prevent heat loss and keep the outer door cool while baking.	This is normal. Under certain light or angles, you may see this tint or rainbow color.
"Shut Door" flashes in the display	The oven door has been left open	Close door and normal mode will resume
Cooking mode shuts off when door left open	Door left open after "Shut Door" flashed in display.	Close door and normal mode will resume

Troubleshooting tips ... Before you call for service

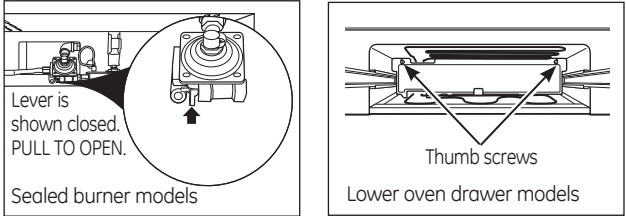
Problem	Possible Cause	What To Do
Top burners do not light or do not burn evenly. (The front right burner is designed to have slightly smaller flames between the 6 and 9 o'clock positions. This is normal.)	Plug on range is not completely inserted in the electrical outlet.	Make sure electrical plug is plugged into a live, properly grounded outlet.
	Burner slits on the side of the burner may be clogged.	Remove the burners and clean them. Check the electrode area for burned-on food or grease. See the Care and cleaning of the range section.
	Improper burner assembly..	Make sure the burner parts are installed correctly. See the Care and cleaning of the range section.
Burner flames very large or yellow	Improper air to gas ratio.	If range is connected to LP gas, contact the person who installed your range or made the conversion.
Surface burners light but oven does not	The oven gas shut-off valve may have accidentally been moved during cleaning or moving.	To check the oven gas shut-off valve, remove the drawer (see the Care and cleaning of the range section). For lower oven drawer models, remove the rear access panel by unscrewing the thumb screws in the upper left and right corners. Look for the gas shut-off lever at the back of the range.  <p>The diagram consists of two parts. The left part, labeled 'Sealed burner models', shows a close-up of a burner assembly with a lever. An arrow points to the lever with the text 'Lever is shown closed. PULL TO OPEN.' The right part, labeled 'Lower oven drawer models', shows the rear access panel of an oven with two thumb screws being removed, indicated by arrows and the text 'Thumb screws'.</p>
Burners do not light	Plug on range is not completely inserted in the electrical outlet.	Make sure electrical plug is plugged into a live, properly grounded outlet.
	Gas supply not connected or turned on.	See the Installation Instructions that came with your range.
	Bridge burner won't light	See How to Light Bridge Burner section.
	A fuse in your home may be blown or the circuit breaker tripped.	Replace the fuse or reset the circuit breaker.
	Burner parts not replaced correctly.	See the Care and Cleaning of the range section.
Lock Controls or Control Lockout feature is activated		If CONTROL (and a lock symbol) appears in the display, the range control is locked. Turn this feature off to use the range. See the Lock Control feature in the Oven Controls section.
“TURN BURNERS OFF” flashes in the display	A cooktop burner was on when the range was going into or out of self-clean modes	Turn all burners off.

Troubleshooting tips ... Before you call for service

Problem	Possible Cause	What To Do
Drawer does not slide smoothly or drags	The drawer is out of alignment.	Fully extend the drawer and push it all the way in. See the Care and cleaning of the range section.
	Drawer is over-loaded or load is unbalanced.	Reduce weight. Redistribute drawer contents.
Lower oven drawer or warming drawer will not work	A fuse in your home may be blown or the circuit breaker tripped.	Replace the fuse or reset the circuit breaker.
	The oven is self-cleaning.	Wait for the self-clean cycle to finish and the oven to cool.
	Controls improperly set.	See the Electric warming drawer or Lower oven drawer section.
Excessive condensation in the drawer	Liquid in drawer.	Remove liquid.
	Uncovered foods.	Cover food with lid or aluminum foil.
	Temperature setting too high.	Reduce temperature setting.
Food dries out in the lower oven drawer or warming drawer	Moisture escaping.	Cover food with lid or aluminum foil.
	Drawer not fully closed.	Push drawer in until latch engages.