

 **Whirlpool**<sup>®</sup>  
Home Appliances  
JUST IMAGINE<sup>®</sup>



W H I R L P O O L<sup>®</sup>



W A S H E R S & D R Y E R S



# *Clean More*

**THAN YOU EVER THOUGHT POSSIBLE**  
larger loads • broader range of fabrics • different types of items

*Shown Stacked in Biscuit • Model number: GHW9250MT*



**Whirlpool® home appliances** are dedicated to solving the riddle of your busy life. Using breakthrough innovations, premium performance, streamlined technology, and environmental savvy, all Whirlpool appliances are designed to help you not merely manage tasks, but enjoy more of each day.

Every Whirlpool appliance fuses form with function by adding a splash of designer panache to your home. Our laundry systems are no exception. Whether you're shopping for a washer, a dryer, or a matching pair, choose from a wide assortment of top-loading or front-loading models with electronic or rotary controls. Capacity, fabric care, and ease of use are promises among all. Seldom can a manufacturer offer the perfect fit for your home like Whirlpool brand does. Your preferences are our priorities.

**For a top-loading washer and dryer, select the color that complements your decor:**



**WHITE WITH SILVER METALLIC**



**BISCUIT WITH GOLD METALLIC**



**WHITE-ON-WHITE**



**BISCUIT-ON-BISCUIT**

*See page 3 for front-loading washer and dryer color options.*

*As always, thank you for considering Whirlpool brand for your next appliance purchase.*



Use this easy to follow Whirlpool® washer and dryer reference to find the models and features ideal for your home.

Each washer and dryer belongs to either the Front-Loading Whirlpool® Duet® series, Top-Loading Whirlpool Gold® series, Whirlpool® Ultimate Care™ II series or Whirlpool® traditional series of models. As you learn about Whirlpool features and discover the ones that are most useful to you, simply refer to the details highlighted on the border of the page. This can help you find the model series that has the feature(s) you want.

The **Front-Loading Whirlpool Duet®** series is our feature-rich premium line of washers and dryers with a European-inspired design that saves water and energy while providing outstanding cleaning performance.

The **Top-Loading Whirlpool Gold®** series also features premium performance and fabric care innovation like Calypso® wash motion and Catalyst® cleaning action.

The Whirlpool **Ultimate Care™ II** series includes a wide variety of cleaning and fabric care features.

The **Whirlpool traditional** series is a popular mix of feature-filled products designed for years of reliable fabric care and cleaning.



Imagine owning a washer that cleans virtually all washable fabrics in your home...from silks to stuffed animals...a revolutionary system with a higher intelligence and the capacity to match. **Wash your world clean** with a Duet® or Duet HT® fabric care system.

# Clean up to 16 pairs of jeans\*

# IN ONE LOAD!

## CLEAN HUGE LOADS AND BULKY ITEMS RIGHT AT HOME

Meet the washer so big you can wash 16 pairs of jeans in a single load.\* Plus, save time by washing bulky items like washable blankets and comforters in your own laundry room instead of lugging them to the laundromat. The enormous wash basket and the new Bulky Items cycle (on Duet HT® washer only) ensure thorough cleaning of these big loads.

## CLEAN VIRTUALLY ANY WASHABLE FABRIC IN YOUR HOME

No need to panic when your favorite blouse isn't in the closet. The customized Silk and Wool cycles (on Duet HT® washer only) and the Hand Washables cycle with Cradle Clean™ technology keep your fine fabrics looking fine—at your convenience—and reduces those last-minute trips to the dry cleaners.†

The Duet HT® washer is the first washer in the USA certified by Woolmark for washable wools



FRONT LOADING WHIRLPOOL® FABRIC CARE



## SANITARY CYCLE (DUET HT® WASHER ONLY)

The "HT" stands for Heater, built into the washer. Fabrics stay safe, bacteria does not. The Sanitary cycle cleans items like baby bibs and blankets with temperatures up to 153°F, destroying 99.999% of certain bacteria.\*\*



Virtually forget about time spent looking for stains and manually pretreating them. With continuous Catalyst® cleaning action detergent is premixed at the beginning of the cycle to break down protein- or oil-based stains. The result? Stains and heavy soils are removed without pretreating.



\*Various sizes  
 \*\*K. pneumonia, P. aureginosa and S. aureus  
 †Always follow manufacturer's care instructions

**EXCEEDS 2007 FEDERAL ENERGY STANDARDS!**

The built-in heater (Duet HT® only) means less energy is needed from your home's hot water heater. Automatic water leveling determines just the right amount of water needed for each load.

**DUET® FABRIC CARE SYSTEMS USE 68% LESS WATER†† AND 67% LESS ENERGY!††**



††Savings compared to average conventional washers, normal cycle, 10 loads per week.



**GHW9250M — Duet HT® WASHER**

The Duet HT® washer includes all the same features as the GHW9100L, plus:

- + Built-In Heater
- + 1100 RPM Maximum Spin Speed
- + Special Cycles: Bulky, Sanitary, Quick Wash, Silk, Wool
- + Porcelain-on-Steel Top
- + 4-Tray Dispenser System (Prewash, Detergent, Bleach and Fabric Softener)
- + Prewash and Auto Soak Options
- + Delay Start



**GHW9100L — DUET® WASHER**

- Catalyst® Cleaning Action with Direct Inject
- Ultra Capacity Plus Stainless Steel Wash Basket
- AccuWash™ Temperature Control
- 900 RPM Maximum Spin Speed
- Special Cycles: Whitest Whites, Heavy Duty, Hand Washables, Add-a-Garment
- 3-Tray Dispenser System (Detergent, Bleach and Fabric Softener)



**GE/GW9200L — DUET® DRYER**

- Senseon™ Drying System
- AccuDry™ Sensor
- Dry Rack Included
- On/Off Wrinkle Shield™ Plus Option (120 minutes)
- Interior Drum Light
- Porcelain-on-Steel Top
- Quiet Dry™ Plus Sound Insulation
- 4-Way Venting



The Duet® dryer features a reversible side-swing door with a manufacturer's exclusive door window. You can learn about Duet® dryer features listed to the left on pages 11-14.

**The Duet HT® pair is now available in three colors:**

- Biscuit
- Pewter
- White with Dove Grey



Shown with optional pedestals. For complete Duet® feature packages, see page 18.

FRONT LOADING WHIRLPOOL® FABRIC CARE

## CALYPSO® WASH MOTION



It's the only washer that gives you the capacity, performance, and efficiency of a front-loading machine in a traditional top-loading design. Calypso® wash motion replaces a conventional agitator with the ingenious Calypso® wash plate, making room for larger loads and bulky items. Plus, the Calypso® washer dances fabrics through a shower of detergent and water lather, followed by 100% fresh waterfall rinses. It's far less stress to garment fibers so fabrics look new longer.



# Clean larger loads and more fabric types

WHIRLPOOL® CALYPSO® WASHER AND DRYER



## NO ONE OFFERS MORE USABLE CAPACITY IN A TOP-LOADING WASHER\*

Without an agitator in the center of the wash basket, you'll clean and care for items you never thought possible. That's because the Whirlpool® Calypso® washer is equipped to clean large loads thoroughly and bulky items safely. Use the Bulky Items cycle to save time by cleaning virtually any oversized washable item you used to take to the laundromat or dry cleaners.

*\*Among leading brands*



## VERSATILE FABRIC CARE

Treat your silks, lingerie, nylons, workout-wear, and other fine delicates to Calypso® wash motion. It's so gentle, you can safely clean virtually any washable fabric right at home. You might even decide to clean items you never thought to wash before, like sheer curtains.

For items you've always washed at home, like denims and cottons, you'll notice they're cleaner and brighter than ever. There's never been such a complete top-loading fabric care system with so many customized and convenient cleaning options, including a **Whitest Whites** cycle.



## TRIPLE DISPENSER SYSTEM AND AUTOMATIC WATER LEVEL

Load virtually any type of washable fabric in your Calypso® washer and let it do the rest. The Triple Dispenser System holds detergent, bleach, and fabric softener until it releases each one at the precise moment during the cycle. There's no need to return for mid-cycle adjustments. And regardless of load size, the built-in water level sensor knows just the right amount of water to use. There's no worry that you've selected too much or too little water to clean.



### USES 50% LESS WATER\*

The Calypso® washer never deep fills, so it uses dramatically less water in every load. Save approximately 10,300 gallons of water per year.\*

### USES 66% LESS ENERGY\*

The AccuWash™ temperature control system ensures consistent wash and rinse temperatures for maximum performance and energy efficiency.

### SAVE OVER \$100 A YEAR!\*

With such significant water and energy savings, dollar savings naturally follow. Reduce your monthly utility costs and save up to \$100 a year.

\*Savings compared to average conventional washers using average water, sewer and electric rates, and electric hot water heat, normal cycle, 10 loads per week.



### GVW9959K — CALYPSO® WASHER

- Calypso® Wash Motion with Continuous Catalyst® Cleaning Action
- Ultra Capacity Stainless Steel Wash Basket
- Variable Speed Motor
- Multiple Wash/Spin Speed Combinations
- Multiple Factory Pre-Set Cycles and Options
- Automatic Water Level Control
- Special Cycles: Whitest Whites, Wool, Jeans/Darks, Delicate/Casual, Bulky Items, Hand Wash
- Porcelain Top and Lid



For best results, use only high-efficiency detergent designed for low-water washers, like Tide® HE.



### GE/GW9868K — MATCHING DRYER

- Senseon™ Drying System
- Ultra Capacity 7.4 cu. ft.
- 11 Cycles
- 6 Temperatures
- Dry Rack
- Interior Drum Light
- On/Off Wrinkle Shield™ Plus Option (120 min.)
- SpillGuard™ Porcelain-on-Steel Top
- 4-Way Venting



For Calypso® matching dryer feature descriptions, see pages 11-14.



Choose a Calypso® washer and dryer pair in the white, biscuit or striking pewter color option.

For complete washer feature package, see pages 18-19. For complete dryer feature package, see pages 20-21.

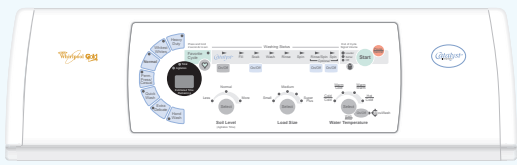
**GSX9885J**

- Catalyst® Cleaning Action  
*(see page 2 for a description of this pretreating feature)*
- Super Capacity Plus White Porcelain-on-Steel Wash Basket
- True 3-Speed Motor with Multiple Wash/Spin Speed Combinations
- Multiple Factory Pre-Set Cycles and Options
- Special Cycles: Whitest Whites, Extra Delicate, Hand Wash, Quick Wash
- 8 Temperatures
- 5 Water Levels
- Triple Dispenser System

Available in White and Biscuit

See matching dryer on page 11.

**GST9679L**

- Super Capacity Plus White Porcelain-on-Steel Wash Basket
- True 3-Speed Motor with 6 Wash/Spin Speed Combinations
- Xtra Roll Action™ Plus Agitator
- Smart Bleach™ Dispenser
- 27 Cycles
- Special Cycles: Handwash/Wool, Knits/Blends, Quick Wash, Pretreat
- 6-Position Fabric Select Control
- Variable Water Levels
- Stepped Spin
- Quiet Wash™ Plus Sound Insulation

Available in White with Silver Metallic Console and Biscuit with Gold Metallic Console

For complete washer feature packages, see pages 18-19.

# Clean twice the average size load!\*

## XTRA ROLL ACTION™ AGITATOR

Dirty laundry piles disappear with the Super Capacity Plus Wash Basket and Xtra Roll Action™ Plus agitator. Dual agitation consistently and gently circulates all wash items to the bottom of the basket where cleaning takes place. **Completely clean twice the average size load.\***

## NO OTHER PORCELAIN WASH BASKET IS LARGER

The Super Capacity Plus white porcelain-on-steel wash basket provides the room needed to clean larger loads, allowing you to reduce time in the laundry room. Plus, it resists scratches, stains, chips and odors. Fabrics have less chance to catch or snag. White porcelain-on-steel wash baskets are guaranteed with a **Limited Lifetime Warranty.\*\***



## SMART BLEACH™ DISPENSER

Spend time doing other things rather than waiting to add bleach to the wash. The Smart Bleach™ Dispenser transforms one cup of liquid chlorine bleach into a whitening powerhouse by waiting until the optimal moment in the cycle to release it. You'll notice the difference in your whites when dirty socks start to dazzle.

For even less time spent in the laundry room, look for models with the **Triple Dispenser** system that automatically dispenses detergent, bleach, and fabric softener. You only need to load and unload, the rest is done for you.

\*Average size load is 7 lbs. \*\*See dealer or Use & Care Guide for details.





### TRUE 3-SPEED MOTOR WITH 6 WASH/SPIN SPEED COMBINATIONS

Skip a trip to the cleaners and wash more types of washable fabrics at home. Three true wash speeds provide fast, slow and extra slow wash actions. Care for a variety of fabrics, from denims to delicates, safely and completely.

The **Hand Washables cycle** goes a step further with an extra slow agitate and soak progression and a slow speed spin for the ultimate protection against fabric damage.

## Save time, water & energy



### WATER AND ENERGY SAVING MODELS

Clean your largest loads while still saving water and energy.

Water-saving spray rinses in model GSW9559L **save up to 9,700 gallons of water a year.\*** Or choose model GSW9650L which uses an advanced temperature control system for 38% less energy in every cycle.\* Make your choice for capacity and conservation.

*\*Savings compared to average conventional washers, normal cycle, 10 loads per week.*

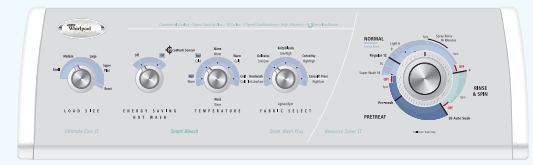

### GSW9559L



- ENERGY STAR® Qualified — Save 9,700 Gallons of Water a Year\*
- Resource Saver® II Wash System
- Super Capacity Plus White Porcelain-on-Steel Wash Basket
- 2-Speed Motor with 5 Wash/Spin Speed Combinations
- Xtra Roll Action™ Plus Agitator
- 18 Cycles
- Smart Bleach™ Dispenser
- 5-Position Fabric Select Control
- Handwash/Wool Cycle
- Variable Water Levels
- Quiet Wash™ Plus Sound Insulation

*Available in White with Silver Metallic Console*

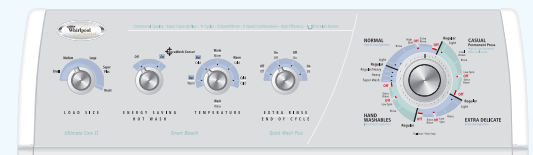

### GSW9650L



- ENERGY STAR® Qualified — Use 38% Less Energy in Every Cycle\*
- Super Capacity Plus White Porcelain-on-Steel Wash Basket
- True 3-Speed Motor with 6 Wash/Spin Speed Combinations
- Xtra Roll Action™ Plus Agitator
- 11 Cycles
- Hand Washables and Extra Delicates Cycles
- Variable Water Levels
- Smart Bleach™ Dispenser
- Quiet Wash™ Plus Sound Insulation

*Available in White with Silver Metallic Console*

*For complete washer feature packages, see pages 18-19.*

TOP LOADING WHIRLPOOL GOLD® WASHERS

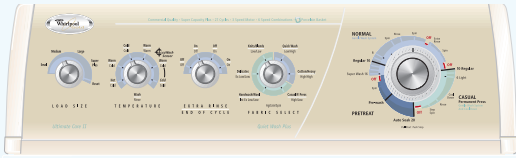

### GSQ9669L

- Super Capacity Plus White Porcelain-on-Steel Wash Basket
- True 3-Speed Motor with 6 Wash/Spin Speed Combinations
- Xtra Roll Action™ Plus Agitator
- 27 Cycles
- 6-Position Fabric Select Control
- Extra Rinse
- End-of-Cycle Signal
- Variable Water Levels
- AccuWash™ Temperature Control
- Stepped Spin
- Quiet Wash™ Plus Sound Insulation

Available in White with Silver Metallic Console and Biscuit with Gold Metallic Console

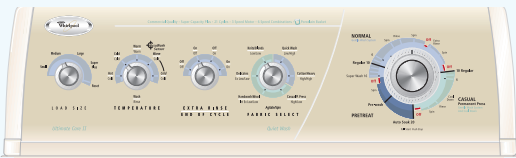

### LSQ9659L

- Super Capacity Plus White Porcelain-on-Steel Wash Basket
- True 3-Speed Motor with 6 Wash/Spin Speed Combinations
- Xtra Roll Action™ Plus Agitator
- 21 Cycles
- 6-Position Fabric Select Control
- Extra Rinse
- End-of-Cycle Signal
- Variable Water Levels
- AccuWash™ Temperature Control
- Quiet Wash™ Sound Insulation

Available in White with Silver Metallic Console and Biscuit with Gold Metallic Console



### LSQ9549L

- Super Capacity Plus White Porcelain-on-Steel Wash Basket
- 5 Wash/Spin Speed Combinations
- Xtra Roll Action™ Plus Agitator
- 9 Cycles
- Extra Rinse
- End-of-Cycle Signal
- Variable Water Levels
- Hand Washables Cycle
- Bleach and Fabric Softener Dispensers
- \* Quiet Wash™ Sound Insulation

Available in White with Silver Metallic Console and Biscuit with Gold Metallic Console

For complete washer feature packages, see pages 18-19.

# Shorten your laundry day



### NEW FABRIC SELECT CONTROL

Simply match the type of load you're cleaning with one of the selections on the Fabric Select control and let the washer do the rest. No speeds to select, no errors to make. From cottons to wools, there's a setting for virtually every garment you'll wash.

### ACCUWASH™ TEMPERATURE CONTROL

Do you know the temperature of your wash water? Of course not, but AccuWash™ temperature control does. It automatically keeps cold washes above 70°F, the recommended temperature to help dissolve detergents, and warm washes from exceeding 100°F, to help control shrinking and bleeding.



### PERMANENT PRESS CYCLE

A cool-down process at the end of the Permanent Press cycle stops wrinkles where they start (in the washer). Clothes are ready to wear without ironing. Some models offer a unique stepped spin feature to help reduce wrinkles while removing more water from the load.

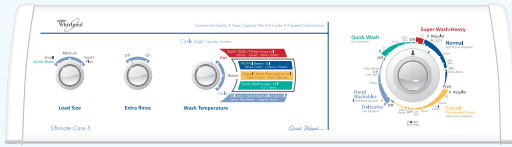

**LSQ800L**

- Cycle Logic™ Color-Coordinated Controls
- Super Capacity Plus White Porcelain-on-Steel Wash Basket
- 5 Wash/Spin Speed Combinations
- Xtra Roll Action™ Plus Agitator
- 8 Cycles
- 3 Water Levels
- 3 Temperatures
- Extra Rinse
- Bleach and Fabric Softener Dispensers

Available in White

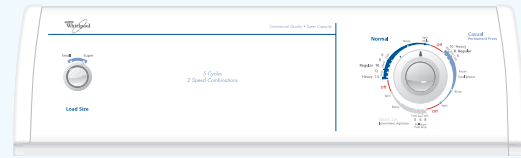

**LSR5232L**

- Super Capacity Porcelain-on-Steel Wash Basket
- 2 Wash/Spin Speed Combinations
- 5 Cycles
- 2 Water Levels
- 3 Temperatures
- Surgilator® Agitator
- SpillGuard™ Top

Available in White

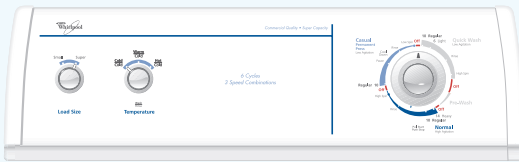

**LSR6332K**

- Super Capacity Porcelain-on-Steel Wash Basket
- 3 Wash/Spin Speed Combinations
- 6 Cycles
- 2 Water Levels
- 3 Temperatures
- 2 Piece Surgilator® Agitator
- Bleach Dispenser

Available in White

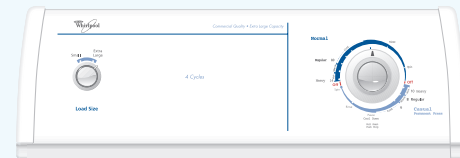

**LBR4132J**

- 24" Extra Large Capacity Porcelain-on-Steel Wash Basket
- 1 Wash/Spin Speed Combination
- 4 Cycles
- 2 Water Levels
- 3 Temperatures
- Straight Vane Agitator
- SpillGuard™ Top

Available in White

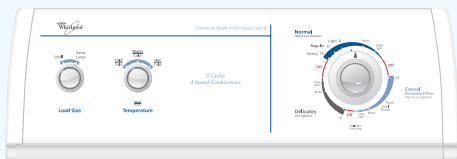

**LBR5432L**

- 24" Extra Large Capacity Porcelain-on-Steel Wash Basket
- 4 Wash/Spin Speed Combinations
- 5 Cycles
- 2 Water Levels
- 3 Temperatures
- Straight Vane Agitator
- SpillGuard™ Top

Available in White

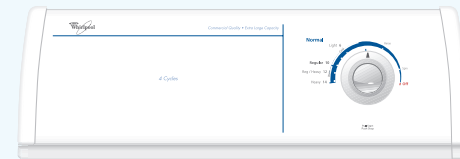

**LBR4121J**

- 24" Extra-Large Capacity Porcelain-on-Steel Wash Basket
- 1 Wash/Spin Speed Combination
- 4 Cycles
- 1 Water Level
- 2 Temperatures
- SpillGuard™ Top

Available in White

ULTIMATE CARE™ II AND WHIRLPOOL® WASHERS

For complete washer feature packages, see pages 18-19.



*Imagine drying time that flies*

# Meet your match with a time-saving dryer

## SENSEON™ DRYING SYSTEM



The laundry room can seem more like a waiting room when wet clothes are sitting in the washer and the previous load is still drying. Get your laundry day up to speed with the Senseon™ drying system that **gently dries fabrics in the time it takes to wash them.\*** Moisture sensing strips and temperature sensors know how fast clothes are drying, how hot the air should be, and when clothes are dry. *It's our most accurate drying system ever.*



## DELICATE CYCLE

If you think any of your fine garments are too delicate to go into the dryer, think again. Whirlpool® Senseon™ dryers offer the gentle care of a Delicates Cycle. Ultra low temperatures never exceed 140°F, as recommended by a leading consumer magazine, to protect fabrics and help prevent damage. *(Always check manufacturer's care label for instructions.)*

## RESOURCE SAVER® DRY CYCLE

**Save over 30% in energy usage\*\*** without sacrificing drying performance. The Whirlpool® Resource Saver® cycle uses a dual temperature heating element. High power boosts heat to the desired temperature before the lower wattage element kicks in to maintain it. **It's the most energy-efficient drying cycle in the industry.†**

\*Based on a 15 lb. load using Senseon™ Heavy Duty  
\*\*As compared to our automatic dry cycles  
†Electric model only

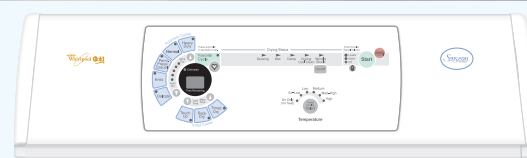

## GE/GX9868J

- Senseon™ Drying System
  - Super Capacity Plus 7.0 cu. ft.
  - 11 Cycles
  - 6 Temperatures
  - Dry Rack
  - Wrinkle Shield™ Plus Option (120 min.)
  - SpillGuard™ Porcelain-on-Steel Top
  - Quiet Dry™ Plus Sound Insulation
- Available in White and Biscuit*



Wide-Opening Hamper Door

WHIRLPOOL GOLD® DRYERS

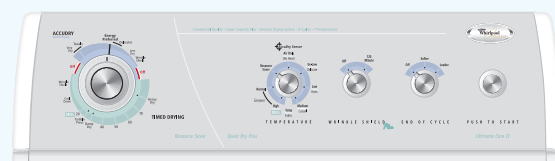

## GE/GW9878L

- Senseon™ Drying System
  - Resource Saver® Dry Cycle
  - 30% Energy Savings\*
  - Super Capacity Plus 7.0 cu. ft.
  - 9 Cycles
  - 7 Temperatures
  - Wrinkle Shield™ Plus Option (120 min.)
  - Quiet Dry™ Plus Sound Insulation
- Available in White with Silver Metallic Console and Biscuit with Gold Metallic Console*



Wide-Opening Hamper Door

*For complete dryer feature packages, see pages 20-21.*

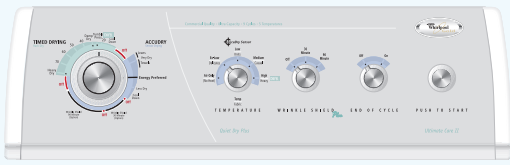

**GE/GQ9800L**

- AccuDry™ Sensor
- Ultra Capacity 7.4 cu. ft.
- 9 Cycles
- 5 Temperatures
- Wrinkle Shield™ Plus Option (90 min.)
- Quiet Dry™ Plus Sound Insulation
- Front-Mounted Lint Screen
- 4-Way Venting
- 27" Width Cabinet

Available in White with Silver Metallic Console and Biscuit with Gold Metallic Console



Wide-Opening Hamper Door



**LE/GQ9858L**

- AccuDry™ Sensor
- Super Capacity Plus 7.0 cu. ft.
- 9 Cycles
- 5 Temperatures
- Wrinkle Shield™ Plus Option (90 min.)
- Quiet Dry™ Sound Insulation

Available in White with Silver Metallic Console and Biscuit with Gold Metallic Console



Wide-Opening Hamper Door

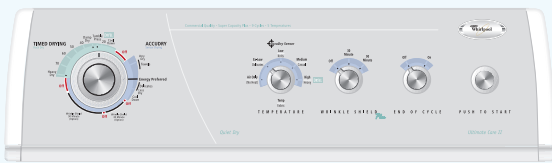

**LE/GQ9857L**

- AccuDry™ Sensor
- Super Capacity Plus 7.0 cu. ft.
- 9 Cycles
- 5 Temperatures
- Wrinkle Shield™ Plus Option (90 min.)
- Quiet Dry™ Sound Insulation

Available in White with Silver Metallic Console and Biscuit with Gold Metallic Console



Super Wide Side-Swing Door

For complete dryer feature packages, see pages 20-21.

**WRINKLE SHIELD™ PLUS OPTION**

It's a fact ... when the dryer quits, wrinkles set in. When you can't unload the dryer right away, choose the Wrinkle Shield™ Plus drying option. Once the cycle is over, Wrinkle Shield™ Plus automatically continues to tumble the load on and off, without heat, for up to 120 minutes. With less chance that wrinkles will set in, you save time ironing.



**ACCUDRY™ SENSOR**

Save time and effort when you're not returning to the dryer to check and re-check progress. The AccuDry™ sensor monitors remaining moisture and automatically stops the cycle when a load is dry. Prevent overdrying while saving time.



**DRY RACK**

Give the laundry line a rest and dry "lay flat" items in the dryer instead. Select models include a dry rack which gives you the freedom to quickly and safely dry hand washable and delicate items in the dryer without tumbling them.



**INTERIOR LIGHT**

Perfect for dark basements, hallways or closets. Interior drum lighting illuminates the entire drum so you have an easier time loading and unloading, no matter where the dryer is located.



### ULTRA CAPACITY

Clothes dry faster and with fewer wrinkles when they have more room to spread out. The largest capacity Whirlpool® dryer ever, the Ultra Capacity dryer measures an enormous 7.4 cubic feet for your largest laundry demands. It's perfect for drying bulky items like comforters, pillows, and rugs.

### ADDITIONAL CAPACITY CHOICES

In addition to Ultra Capacity, Whirlpool brand offers a variety of other dryer capacities to meet your fabric care needs. Super Capacity Plus dryers offer a 7.0 cubic foot drum to dry large, family-size loads with fluffy results. Other size options include a 6.5 cubic foot Super Capacity drum and a 5.9 cubic foot Extra-Large size. A larger capacity equals fewer wrinkles and less time spent ironing.



### GENTLE HEAT SYSTEM

Unload the dryer as soon as the cycle is over. Virtually every Whirlpool® dryer features the Gentle Heat System which lowers the temperature to the lowest setting for the last five to seven minutes, followed by a cool-down period. Loads are never too hot to handle and there's less risk of fabric damage.

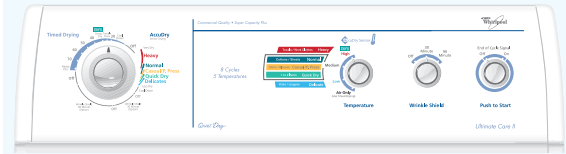

### LE/GQ8000J

- AccuDry™ Sensor
- Cycle Logic™ Color-Coordinated Controls
- Super Capacity Plus 7.0 cu. ft.
- 8 Cycles
- 4 Temperatures
- Quiet Dry™ Sound Insulation
- Wrinkle Shield™ Plus Option (90 min.)

Available in White.

See matching LSQ8000L washer on page 9.



Wide-Opening Hamper Door

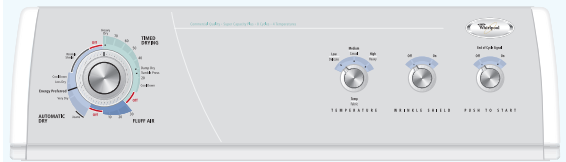

### LE/GR8648L

- Super Capacity Plus 7.0 cu. ft.
- 8 Cycles
- 4 Temperatures
- Jeans Cycle
- Damp Dry Cycle
- Wrinkle Shield™ Option (45 min.)

Available in White with Silver Metallic Console and Biscuit with Gold Metallic Console



Wide-Opening Hamper Door

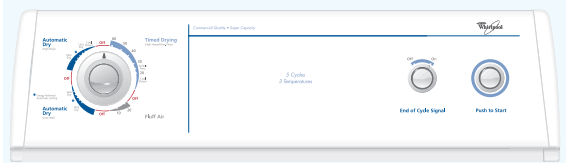

### LE/GR5636L

- Super Capacity Plus 6.5 cu. ft.
- 5 Cycles
- 3 Temperatures
- Automatic Dry Control
- Tumble Press® Cycle

Available in White and Biscuit



Wide-Opening Hamper Door

For complete dryer feature packages, see pages 20-21.

# A perfect fit for your lifestyle

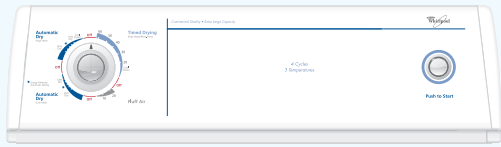

## LE/GR4634J & LE/GV4634J

- Extra-Large Capacity
- 4 Cycles
- 3 Temperatures (in Timer)
- Automatic Dry Control
- Long Venting System

For Better Air Flow (LE/GV4634J only)

Available in White and Biscuit  
(LEV4634K available in White only)



Reversible Side-Swing Door



### INDUSTRY'S LARGEST LINT SCREEN

The largest lint filter in the industry delivers optimal air flow for faster drying. On most models, it's located on top of the cabinet, away from clean clothes, so it's easy to reach and clean.

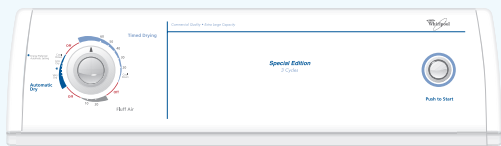

## LE/GR3624J

- Extra-Large Capacity
- 3 Cycles
- 2 Temperatures
- Automatic Dry Control

Available in White



Side-Swing Door

### SPILLGUARD™ TOP

Accidents happen and the SpillGuard™ Top makes them easier to clean up. Store detergents, bleach and fabric softener on top of the dryer and the raised edges help prevent accidental spills from falling to the floor.



### DRYER DOOR CONFIGURATIONS

The Wide-opening hamper door is an industry exclusive that allows you to fold as you unload. The Reversible Side-Swing Door is ideal for flexible installation. The Super Wide-Opening Reversible Side-Swing Door measures 293 square inches and makes for easy loading and unloading of big, bulky items like comforters and pillows.

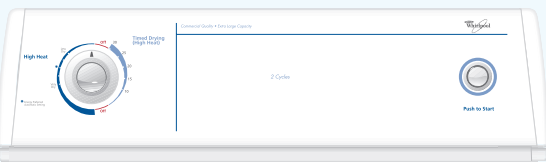

## LER2614J

- Extra-Large Capacity
- 2 Cycles
- 1 Temperature
- Electric Only

Available in White



Side-Swing Door



Wide-Opening Hamper Door



Super Wide-Opening Reversible Side-Swing Door



Reversible Side-Swing Door

For complete dryer feature packages, see pages 20-21.

WHIRLPOOL® DRYERS



# Good things come in *small packages*

Whirlpool® compact washers and dryers are an excellent solution for small spaces. Featuring gentle washing and drying systems, delicate wash cycles, bleach and fabric softener dispensers, and electronic Dry-Miser® controls\*, these full-service units mean you never have to sacrifice fabric care when you have minimal space.

*\*LDR3822D model only*

## LCR7244H COMPACT WASHER



- 1-Piece Flex Agitator
- Bleach/Fabric Softener Dispenser
- 2 Wash Speeds
- 1 Spin Speed
- 7 Automatic Cycles
- 4 Water Levels
- 4 Temperature Combinations
- Super Wash Cycle
- Permanent Press Cycle
- Knits/Gentle Cycle
- Spin Only Option
- Easy-to-Clean Lint Filter
- 22-1/2" Cabinet
- Lighted Cycle Indicators
- Porcelain-on-Steel Basket
- Removable Casters Attached

*Available in White*

### SIMILAR MODEL LCR5232

- 1-Piece Flex Agitator
- Bleach/Fabric Softener Dispenser
- 2 Wash Speeds
- 1 Spin Speed
- 5 Automatic Cycles
- 2 Water Levels
- 3 Temperature Combinations
- Permanent Press Cycle
- Short Cycle
- Delicate Cycle
- Easy-to-Clean Lint Filter
- 22-1/2" Cabinet
- Lighted Cycle Indicator
- Porcelain-on-Steel Basket
- Caster Kit Available

*Available in White*

## LDR3822D COMPACT DRYER



- 120V Heat System
- 3 Cycles
- 2 Temperature Selections
- Electronic Dry-Miser® Control
- Timed Drying
- Fluff Air
- 24" Cabinet
- Side-Swing Door
- Interior Lint Screen
- DuraWhite™ Interior

*Available in White*

### SIMILAR MODEL LER3622

- 220V Heat System
- 3 Cycles
- 2 Temperature Selections
- Permanent Press Cycle
- Timed Drying
- Fluff Air
- 24" Cabinet
- Side-Swing Door
- Interior Lint Screen
- DuraWhite™ Interior

*Available in White*

WHIRLPOOL® COMPACT WASHERS AND DRYERS



# Big *in performance...* even when you're short on space

Looking for excellent fabric care but have a confined laundry area, like in a bathroom or closet? **Whirlpool® Thin Twin® washer and dryer laundry centers** are the answer! Available in 27-inch and 24-inch widths, these space-saving washer and dryer combos deliver the outstanding fabric care you expect from Whirlpool brand.

## LTE6234D (elec) • LTG6234D (gas)

- Full-Size Thin Twin® Washer & Dryer
  - Extra-Large Capacity
- Available in White and Biscuit



### Washer:

- Gentle Wash System
- 2-Piece Surgilator® Agitator
- 6 Automatic Cycles
- 4 Water Levels
- 5 Wash/Spin Speed Combinations
- 3 Wash/Rinse Temperatures
- ToughTop II™ Top and Lid Finish
- White Porcelain Basket
- Self-Cleaning Lint Filter
- 1/2 Horsepower Motor

### Dryer:

- Gentle Heat System
- Automatic Dry Control
- 6 Cycles
- 3 Temperatures
- Tumble Press® Cycle
- On/Off End-of-Cycle Signal
- Side-Swing Door
- DuraWhite™ Interior
- Front-Mounted Lint Screen
- 1/3 Horsepower Motor



## LTE5243D (elec) • LTG5243D (gas)

- Compact Thin Twin® Washer & Dryer
  - Large Capacity
- Available in White and Biscuit



### Washer:

- Gentle Wash System
- Surgilator® Agitator
- 5 Automatic Cycles
- 3 Water Levels
- 5 Wash/Spin Speed Combinations
- ToughTop II™ Top and Lid Finish
- 4 Wash/Rinse Temperatures
- Spreckle Porcelain Basket
- Easy-to-Clean Lint Filter
- 1/2 Horsepower Motor

### Dryer:

- Automatic Dry Control
- 5 Cycles
- 4 Temperature Settings
- End-of-Cycle Signal
- Side-Swing Door
- DuraWhite™ Interior
- Easy-to-Clean Lint Filter
- 1/3 Horsepower Motor



THIN TWIN® LAUNDRY CENTER

# WHIRLPOOL® THIN TWIN® SPECIFICATIONS

## THIN TWIN® WASHERS

**Both Washers Offer:**

- Direct Drive 1/2 HP Motor
- Transition Panel
- Self-Leveling Rear Legs
- Tripod 3-Point Suspension
- Polypropylene Tub
- Corrugated Drain Hose
- Rip Cord Suspension
- Front Serviceability
- 1-5-10 Year Warranty\*

## THIN TWIN® DRYERS

**All Dryers Offer:**

- 180° Side-Swing Door
- Baked Acrylic Enamel Cabinet Finish
- 1-Year Warranty\*
- DuraWhite™ Drum Finish
- Variator Baffles

### THIN TWIN® WASHER FEATURES

	24" Width	27" Width
Model Numbers:	LTE5243D LTG5243D	LTE6234D LTG6234D
<b>WASHING SYSTEM</b>		
Capacity (cu. ft.)	1.5	2.5
Wash and Spin Speeds	2	2
Gentle Wash System	Yes	Yes
Agitator	Surgilator	Double-Duty
Lint Filter	Yes	Yes
<b>WASHER CONTROLS</b>		
Automatic Cycles	5	6
• Super Wash	Yes	Yes
• Regular/Heavy	Yes	Yes
• Permanent Press	Yes	Yes
• Delicate	Yes	Yes
• Soak	—	Yes
• Prewash	Yes	Yes
Wash/Rinse Temperatures	4	3
Water Level Selections	3	4
<b>CONVENIENCE FEATURES</b>		
Fabric Softener Dispenser	—	Pt. #3350834**
Wash Basket	Spreckle	White Porcelain
Tough-Top II™ Top & Lid	Yes	Yes
Color Availability	White/Biscuit	White/Biscuit

### THIN TWIN® DRYER FEATURES

	24" Width		27" Width	
Model Numbers:	LTE5243D	LTG5243D	LTE6234D	LTG6234D
<b>DRYING SYSTEM</b>				
Drum Volume (cu. ft.)	3.4	3.4	5.9	5.9
Dry-Miser® Control	Automatic	Automatic	Automatic	Automatic
Gentle Heat System	Yes	Yes	Yes	Yes
Lint Screen	Yes	Yes	Front Mounted	Front Mounted
<b>DRYER CONTROLS</b>				
Temperature Settings	3	3	3	3
Automatic Cycles	5	5	6	6
• Auto. Regular	Yes	Yes	—	—
• Auto Perm. Press/Heavy (High Heat)	—	—	Yes	Yes
• Auto Permanent Press	Yes	Yes	—	—
• Auto Delicate (Low Heat)	—	—	Yes	Yes
• Timed Drying	Yes	Yes	Yes	Yes
• Tumble Press®	Yes	Yes	Yes	Yes
• Damp Dry	—	—	Yes	Yes
• Fluff Air	Yes	Yes	Yes	Yes
Push-to-Start Button	Yes	Yes	Yes	Yes
End-of-Cycle Signal	Yes	Yes	On/Off	On/Off
<b>QUALITY FEATURES</b>				
4-Way Venting	Yes	Yes	Yes	Yes
Electrical Requirements	240V/208V	120V	240/208V	120V
Electric Heating Element (Watts)	3600	—	4600/3460	—
Gas Burner (BTU)	—	10,500	—	16,000
Approx. Shipping Wt. (lbs.)	276	280	310	340
Color Availability	White/Biscuit	White/Biscuit	White/Biscuit	White/Biscuit

\*See dealer or Use and Care Guide for full details.

\*\*To order replacement parts, please call 800-253-1301 or visit [www.whirlpool.com](http://www.whirlpool.com)

## Venting Information

### Exhaust Information

Service Check: The back pressure in any exhaust system used must not exceed 0.6 inches of water column measured with an incline manometer at the point that the exhaust duct connects to the dryer.

### 24" THIN TWIN® MODELS

# of 90° turns	4" Hood	4" Hood	2 1/2" Hood	
0	43 Ft.	41 Ft.	36 Ft.	Maximum length of 4" diameter rigid metal duct
1	33 Ft.	31 Ft.	26 Ft.	
2	23 Ft.	21 Ft.	16 Ft.	
3	18 Ft.	18 Ft.	Not Recommended	Maximum length of 4" diameter flexible metal duct
0	30 Ft.	29 Ft.	24 Ft.	
1	24 Ft.	23 Ft.	18 Ft.	
2	16 Ft.	15 Ft.	10 Ft.	
3	10 Ft.	9 Ft.	Not Recommended	

### 27" THIN TWIN® MODELS

# of 90° turns	4" Hood	4" Hood	2 1/2" Hood	
0	42 Ft.	42 Ft.	42 Ft.	Maximum length of 4" diameter rigid metal duct
1	34 Ft.	34 Ft.	34 Ft.	
2	26 Ft.	26 Ft.	26 Ft.	
0	26 Ft.	26 Ft.	26 Ft.	Maximum length of 4" diameter flexible metal duct
1	21 Ft.	21 Ft.	21 Ft.	
2	16 Ft.	16 Ft.	16 Ft.	





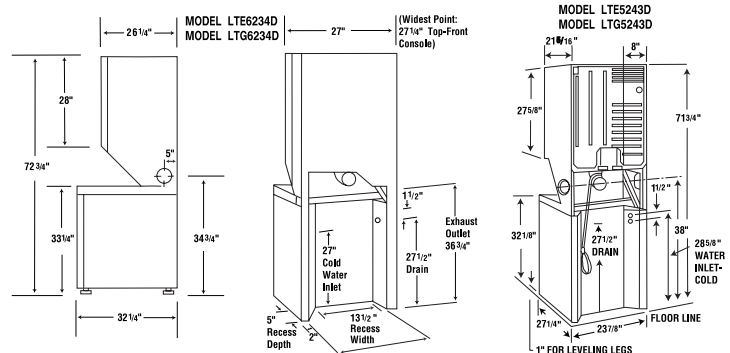
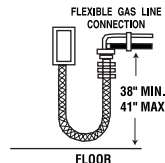

## Thin Twin Dimensions

(all dimensions shown in inches)











# WHIRLPOOL® WASHER FEATURES

WHIRLPOOL® WASHER FEATURES

MODEL NUMBER:	ULTRA CAPACITY PLUS FRONT LOAD		ULTRA CAPACITY TOP LOAD	SUPER CAPACITY PLUS TOP LOAD				
	GHW9250M 	GHW9100L 	GVM9959K 	GSX9885J 	GST9679L 	GSW9559L 	GSW9650L 	
<b>WASHING SYSTEM</b>								
Capacity	3.7 cu.ft. IEC*	3.7 cu.ft. IEC*	3.5 cu.ft. IEC*	3.0 cu.ft.	3.2 cu.ft.	3.2 cu.ft.	3.2 cu.ft.	
Wash/Spin Speed Combinations	Multiple	Multiple	Multiple	Multiple	6	5	6	
Motor Speeds	Variable	Variable	Variable	3	3	2	3	
Calypso® Wash Motion	-	-	Yes	-	-	-	-	
Catalyst® Cleaning Action	Yes (continuous)	Yes (continuous)	Yes (continuous)	Yes	-	-	-	
ENERGY STAR® Qualified	Yes	Yes	Yes	-	-	Yes	Yes	
Resource Saver® II Wash System	-	-	-	-	-	Yes	-	
AccuWash™ Temperature Control	Yes	Yes	Yes	Yes	Yes	Yes	Yes	
Quiet Wash™ System	Plus	Plus	Plus	Plus	Plus	Plus	Plus	
Calypso® Wash Plate	-	-	Yes	-	-	-	-	
Xtra Roll Action™ Plus Agitator	-	-	-	Yes	Yes	Yes	Yes	
2-Piece Surgilator® Agitator	-	-	-	-	-	-	-	
Surgilator® Agitator	-	-	-	-	-	-	-	
Straight Vane Agitator	-	-	-	-	-	-	-	
Commercial Agitator	-	-	-	-	-	-	-	
Automatic Lint Filtration	N/A	N/A	N/A	Yes	Yes	Yes	Yes	
<b>WASHER CONTROLS</b>								
Automatic Cycles	Multiple	Multiple	Multiple	Multiple	27	18	11	
• Jeans/Dark Colors	-	-	Yes***	-	-	-	-	
• Bulky Items	Yes**	-	Yes***	-	-	-	-	
• Wool	Yes**	-	Yes***	-	Handwash/Wool	Handwash/Wool	-	
• Silk	Yes**	-	-	-	-	-	-	
• Normal/Casual	Yes**	Yes**	-	-	-	-	-	
• Heavy Duty	Yes**	Yes**	Yes***	Yes	Cotton/Heavy	Cotton/Heavy	-	
• Whitest Whites	Yes**	Yes**	Yes***	Yes	-	-	-	
• Sanitary	Yes**	-	-	-	-	-	-	
• Super Wash	-	-	-	-	Yes	Yes	Yes	
Normal Cycles	-	-	Yes***	Yes	-	-	-	
• Heavy	-	-	-	-	-	-	Yes	
• Regular/Heavy	-	-	-	-	-	-	Yes	
• Regular	-	-	-	-	Yes	Yes	Yes	
• Light	-	-	-	-	-	Yes	Yes	
Casual/Permanent Press Cycles	-	-	-	Yes	Yes	Yes	-	
• Heavy	-	-	-	-	-	-	-	
• Regular	-	-	-	-	Yes	-	Yes	
• Light	-	-	-	-	Yes	-	Yes	
Extra Delicates Cycles	-	-	-	Yes	Knits/Blends	Knits/Blends	-	
• Regular	-	-	-	-	-	-	Yes	
• Light	-	-	-	-	-	-	Yes	
Delicates Cycle	Yes**	Yes**	Delicate/Casual***	-	Yes	Yes	-	
• Regular	-	-	-	-	-	-	-	
Hand Washables	Yes**	Yes**	Yes***	Yes	Handwash/Wool	Handwash/Wool	Yes	
Prewash	Yes	-	-	-	Yes	Yes	-	
Soak	Yes	-	Yes	Yes	Yes	Yes	-	
Quick Wash	Yes**	-	Yes***	Yes	Yes	-	-	
Extra Rinse	On/Off	On/Off	On/Off	On/Off	On/Off	Rinse/Spin	On/Off	
End-of-Cycle Signal	Variable	Variable	Variable	Variable	On/Off	On/Off	On/Off	
Wash/Rinse Temperatures	5	3	5	8	7	5	5	
Water Levels	Automatic	Automatic	Automatic	5	Variable	Variable	Variable	
<b>CONVENIENCE FEATURES</b>								
Smart Bleach™ Dispenser	Yes (flushed)	Yes (flushed)	Yes (flushed)	Yes (flushed)	Yes	Yes	Yes	
Bleach Dispenser	-	-	-	-	-	-	-	
Fabric Softener Dispenser	Yes (flushed)	Yes (flushed)	Yes (flushed)	Yes (flushed)	Yes	-	Yes	
Detergent Dispenser	Yes (flushed)	Yes (flushed)	Yes (flushed)	Yes (flushed)	-	-	-	
Prewash Detergent Dispenser	Yes (flushed)	-	-	-	-	-	-	
SpillGuard™ Top	Yes/Porcelain	Yes	Yes/Porcelain	Yes/Porcelain	Yes	Yes	Yes	
<b>QUALITY FEATURES</b>								
Colors†	W, T, L	W	Q, T, L	Q, T	W, G	W	W	
Wash Basket	Stainless Steel††	Stainless Steel††	Stainless Steel††	White Porcelain††	White Porcelain††	White Porcelain††	White Porcelain††	
Warranty§	1-2-5-10-Life	1-2-5-10-Life	1-5-10-Life	1-5-10-Life	1-5-10-Life	1-5-10-Life	1-5-10-Life	
Approx. Shipping Weight (lbs.)	245 lbs.	245 lbs.	189 lbs.	180 lbs.	174 lbs.	174 lbs.	174 lbs.	

\*Washes equivalent sized loads as a 3.7 or 3.5 agitator-based machine, per IEC ratios, respectively. \*\*Three soil level selections \*\*\*Five soil level selections  
 †White (Q), Biscuit (T), Pewter (L), White with Silver Metallic or White with Dove Grey Accents (W), and Biscuit with Gold Metallic (G)  
 ††Limited lifetime warranty §See dealer or Use & Care Guide for full details.





# WHIRLPOOL® WASHER FEATURES

	SUPER CAPACITY PLUS TOP LOAD				SUPER CAPACITY TOP LOAD			EXTRA LARGE CAPACITY TOP LOAD	
	<b>GSQ9669L</b> 	<b>LSQ9659L</b> 	<b>LSQ8000L</b> 	<b>LSQ9549L</b> 	<b>LSR6332K</b> 	<b>LBR5432L</b> 	<b>LSR5232L</b> 	<b>LBR4132J</b> 	<b>LBR4121J</b> 
	3.2 cu.ft.	3.2 cu.ft.	3.2 cu.ft.	3.2 cu.ft.	3.0 cu.ft.	3.0 cu.ft.	3.0 cu.ft.	2.5 cu.ft.	2.5 cu.ft.
	6	6	5	5	3	4	2	1	1
	3	3	2	2	2	2	1	1	1
	-	-	-	-	-	-	-	-	-
	-	-	-	-	-	-	-	-	-
	-	-	-	-	-	-	-	-	-
	-	-	-	-	-	-	-	-	-
	Yes	Yes	-	-	-	-	-	-	-
	Plus	Yes	Yes	Yes	-	-	-	-	-
	-	-	-	-	-	-	-	-	-
	Yes	Yes	Yes	Yes	-	-	-	-	-
	-	-	-	-	Yes	-	-	-	-
	-	-	-	-	-	-	Yes	-	-
	-	-	-	-	-	Yes	-	Yes	-
	-	-	-	-	-	-	-	-	Yes
	Yes	Yes	Yes	Yes	Yes	Yes	Yes	Yes	Yes
	27	21	8	9	6	5	5	4	4
	-	-	-	-	-	-	-	-	-
	-	-	-	-	-	-	-	-	-
	Handwash/Wool	Handwash/Wool	-	-	-	-	-	-	-
	-	-	-	-	-	-	-	-	-
	-	-	-	-	-	-	-	-	-
	Cotton/Heavy	Cotton/Heavy	-	-	-	-	-	-	-
	-	-	-	-	-	-	-	-	-
	-	-	-	-	-	-	-	-	-
	Yes	Yes	Yes	Yes	-	-	-	-	-
	-	-	-	-	-	-	-	-	-
	-	-	-	Yes	Yes	Yes	Yes	Yes	Yes
	-	-	-	-	-	-	-	-	Yes
	Yes	Yes	Yes	Yes	Yes	Yes	Yes	Yes	Yes
	-	-	Yes	Yes	-	Yes	-	-	Yes
	Yes	Yes	-	-	-	-	-	-	-
	-	-	-	-	-	-	-	Yes	-
	Yes	Yes	Yes	Yes	Yes	Yes	Yes	Yes	-
	Yes	-	-	Yes	-	-	Yes	-	-
	Knits/Blends	Knits/Blends	-	-	-	-	-	-	-
	-	-	-	-	-	-	-	-	-
	-	-	-	-	-	-	-	-	-
	Yes	Yes	-	-	-	-	Gentlewash	-	-
	-	-	Yes	Yes	-	Yes	-	-	-
	Handwash/Wool	Handwash/Wool	Yes	Yes	-	-	-	-	-
	Yes	-	-	-	Yes	-	-	-	-
	Yes	-	-	-	-	-	-	-	-
	Yes	Yes	Yes	-	Regular/Light	-	-	-	-
	On/Off	On/Off	On/Off	On/Off	-	-	-	-	-
	On/Off	On/Off	-	On/Off	-	-	-	-	-
	6	5	3	4	3	3	3 (timer)	3 (timer)	2 (timer)
	Variable	Variable	3	Variable	2	2	2	2	1
	-	-	-	-	-	-	-	-	-
	Yes	Yes	Yes	Yes	Yes	-	-	-	-
	Yes	Yes	Yes	Yes	-	-	-	-	-
	-	-	-	-	-	-	-	-	-
	-	-	-	-	-	-	-	-	-
	Yes	Yes	Yes	Yes	Yes	Yes	Yes	Yes	Yes
	W, G	W, G	Q	W, G	Q	Q	Q	Q	Q
	White Porcelain <sup>††</sup>	White Porcelain <sup>††</sup>	White Porcelain <sup>††</sup>	White Porcelain <sup>††</sup>	Spreckle Porcelain	Spreckle Porcelain	Spreckle Porcelain	Spreckle Porcelain	Spreckle Porcelain
	1-5-10-Life	1-5-10-Life	1-5-10-Life	1-5-10-Life	1-5-10	1-5-10	1-5-10	1-5-10	1-5-10
	174 lbs.	174 lbs.	174 lbs.	174 lbs.	173 lbs.	167 lbs.	173 lbs.	167 lbs.	167 lbs.

WHIRLPOOL® WASHER FEATURES

# WHIRLPOOL® DRYER FEATURES

WHIRLPOOL® DRYER FEATURES

	SUPER CAPACITY PLUS	ULTRA CAPACITY	SUPER CAPACITY PLUS	ULTRA CAPACITY	
Model Number:	GE/GW9200L 	GE/GW9868K 	GE/GX9868J 	GE/GW9878L 	GE/GQ9800L 
<b>DRYING SYSTEM</b>					
Senseon™ Drying System	Yes	Yes	Yes	Yes	-
AccuDry™ Sensor	Yes	-	-	Yes	Yes
Resource Saver® Drying System	-	-	-	Yes	-
Quiet Dry™	Yes	Plus	Plus	Plus	Plus
Extra-Large Lint Screen	Front-Mount	Front-Mount	Top-Cabinet	Top-Cabinet	Front-Mount
<b>DRYER CONTROLS</b>					
Temperature Settings	5	6	6	7	5
• Senseon™ High	-	-	-	Yes	-
• Senseon™ Normal	-	-	-	Yes	-
• Resource Saver® Setting	-	-	-	Yes	-
• High	Yes	Yes	Yes	-	Yes
• Medium/Heavy High	-	Yes	Yes	-	-
• Medium	Yes	Yes	Yes	Yes	Yes
• Low	Yes	Yes	Yes	Yes	Yes
• Extra Low	Yes	Yes	Yes	Yes	Yes
• Air Only	Yes	Yes	Yes	Yes	Yes
<b>AUTOMATIC DRY</b>					
Cycles	10	11	10	9	9
• Automatic Drying	Yes	-	-	-	-
• Timed Drying	Yes	Yes	Yes	Yes	Yes
• Damp Dry	-	-	-	Yes	Yes
• Tumble Press®	-	-	-	Yes	Yes
• Wrinkle Shield™/Minutes	Off/120	Off/120	Off/120	Off/120	Off/90
• Heavy Dry	Yes	Yes	Yes	Yes	Yes
• Towel Dry	-	-	-	Yes	Yes
• Fluff Air	Yes	Yes	Yes	Yes	Yes
• Delicate	Yes	-	-	Yes	Yes
Cycle Logic™ Controls	-	-	-	-	-
<b>CONVENIENCE FEATURES</b>					
Wide-Opening Hamper Door	-	Yes	Yes	Yes	Yes
Large Side-Swing Door	Yes	-	-	-	-
Side-Swing Door	-	-	-	-	-
End-of-Cycle Signal	Variable	Variable	Variable	Variable	On/Off
DuraWhite™ Interior	Yes	Yes	Yes	Yes	Yes
Interior Light	Yes	Yes	Yes	Yes	Yes
SpillGuard™ Top	Yes/Porcelain	Yes/Porcelain	Yes/Porcelain	Yes	Yes
Dry Rack	Yes	Yes	Yes	-	-
<b>QUALITY FEATURES</b>					
Colors*	Q, T, L	Q, T, L	Q, T	W, G	W, G
Electric Heating Element (Watts)	5400	5400	5400	2700/5400	5400
Gas Burner (BTUs)	22,000	22,000	22,000	22,000	22,000
Warranty**	1-5 Year	1-5 Year	1-5 Year	1 Year	1 Year
Venting	4-Way	4-Way	Rear	Rear	4-Way
Approx. Shipping Weight (lbs.)					
• Electric models	149 lbs.	129 lbs.	125 lbs.	123 lbs.	123 lbs.
• Gas models	149 lbs.	134 lbs.	128 lbs.	125 lbs.	125 lbs.
Cabinet Width (inches)	27	27	29	29	27

\* White (Q), Biscuit (T), Pewter (L), White with Silver Metallic or White with Dove Grey Accents (W), and Biscuit with Gold Metallic (G)  
 \*\*See dealer or Use & Care Guide for full details.

# WHIRLPOOL® DRYER FEATURES

	SUPER CAPACITY PLUS			SUPER CAPACITY	EXTRA LARGE CAPACITY				
	LE/GQ9858L Ultimate CareII™	LE/GQ9857L Ultimate CareII™	LE/GQ8000J Ultimate CareII™	LE/GR8648L Whirlpool®	LE/GR5636L Whirlpool®	LE/GR4634J Whirlpool®	LE/GV4634J Whirlpool®	LE/GR3624J Whirlpool®	LER2614J Whirlpool®
	-	-	-	-	-	-	-	-	-
	Yes	Yes	Yes	-	-	-	-	-	-
	-	-	-	-	-	-	-	-	-
	Yes	Yes	Yes	-	-	-	-	-	-
	Top-Cabinet	Top-Cabinet	Top-Cabinet	Top-Cabinet	Top-Cabinet	Top-Cabinet	Top-Cabinet	Top-Cabinet	Top-Cabinet
	5	5	4	4	3 (in timer)	3 (in timer)	3 (in timer)	2 (in timer)	1 (in timer)
	-	-	-	-	-	-	-	-	-
	-	-	-	-	-	-	-	-	-
	Yes	Yes	Yes	Yes	In Timer	In Timer	In Timer	In Timer	In Timer
	-	-	-	-	-	-	-	-	-
	Yes	Yes	Yes	Yes	-	-	-	-	-
	Yes	Yes	Yes	Yes	In Timer	In Timer	In Timer	-	-
	Yes	Yes	-	-	-	-	-	-	-
	Yes	Yes	Yes	In Timer	In Timer	In Timer	In Timer	In Timer	-
	9	9	8	8	5	4	4	3	2
	-	-	-	Yes	Yes	Yes	Yes	Yes	-
	Yes	Yes	Yes	Yes	Yes	Yes	Yes	Yes	Yes
	Yes	Yes	Yes	Yes	-	-	-	-	-
	Yes	Yes	Yes	Yes	Yes	-	-	-	-
	Off/30,90	Off/30,90	Off/30,90	Off/45	-	-	-	-	-
	Yes	Yes	Yes	Yes	-	-	-	-	-
	Yes	Yes	-	Jeans	-	-	-	-	-
	Yes	Yes	Yes	Yes	Yes	Yes	Yes	Yes	-
	Yes	Yes	-	-	-	-	-	-	-
	-	-	Yes	-	-	-	-	-	-
	Yes	-	Yes	Yes	Yes	-	-	-	-
	-	Yes	-	-	-	Yes	Yes	-	-
	-	-	-	-	-	-	-	Yes	Yes
	On/Off	On/Off	On/Off	On/Off	Yes	-	-	-	-
	Yes	Yes	Yes	Yes	Yes	Yes	Yes	Yes	-
	Yes	Yes	Yes	Yes	Yes	-	-	-	-
	Yes	Yes	Yes	Yes	Yes	Yes	Yes	Yes	Yes
	-	-	-	-	-	-	-	-	-
	W, G	W, G	Q	W, G	Q, T	Q, T	Q	Q	Q
	5400	5400	5400	5400	5400	5400	5400	5400	5400
	22,000	22,000	22,000	22,000	22,000	22,000	22,000	22,000	22,000
	1 Year	1 Year	1 Year	1 Year	1 Year	1 Year	1 Year	1 Year	1 Year
	Rear	Rear	Rear	Rear	Rear	Rear	Rear (Long Vent)	Rear	Rear
	122 lbs.	122 lbs.	122 lbs.	122 lbs.	122 lbs.	118 lbs.	118 lbs.	118 lbs.	118 lbs.
	124 lbs.	124 lbs.	124 lbs.	124 lbs.	124 lbs.	122 lbs.	122 lbs.	122 lbs.	-
	29	29	29	29	29	29	29	29	29

WHIRLPOOL® DRYER FEATURES

# WHIRLPOOL® COMPACT WASHER & DRYER SPECIFICATIONS

## COMPACT WASHER SPECIFICATIONS

	Compact 22" LCR7244H Portable*	Compact 22" LCR5232H Stationary*
<b>WASHING SYSTEM</b>		
Capacity	2.0 cu. ft.	2.0 cu. ft.
Wash & Spin Speeds	2 wash / 1 spin	2 wash / 1 spin
Gentle Wash System	Yes	Yes
1-Piece Flex Agitator	Yes	Yes
Easy-to-Clean Lint Filter	Yes	Yes
<b>WASHER CONTROLS</b>		
Automatic Cycles	7	5
• Super Wash	Yes	-
• Normal	-	Yes
• Regular	Yes	-
• Heavy	Yes	-
• Permanent Press	Yes	Yes
• Knits/Gentle	Yes	Yes
• Prewash/Soak	Yes	Yes
• Spin Only	Yes	Yes
Wash/Rinse Temps.	4	3
Water Levels	4	2
<b>CONVENIENCE FEATURES</b>		
Bleach Dispenser	Yes	Yes
Fabric Softener Dispenser	Yes	Yes
Lighted Cycle Indicators	Yes	Yes
<b>QUALITY FEATURES</b>		
Color Availability	-	-
• White	Yes	Yes
• Porcelain Basket Color	Spreckle	Spreckle
Warranty**	1-5-10	1-5-10
Approx. Shipping Wt. (lbs.)	108	108
Motor	1/4 HP	1/4 HP

\*Both models convertible

\*\*See dealer or Use & Care Guide for full details.

## COMPACT DRYER SPECIFICATIONS

	Compact 24" LDR3822D Electric Only	Compact 24" LER3622D Electric Only
<b>DRYING SYSTEM</b>		
Capacity	3.4 cu. ft.	3.4 cu. ft.
Gentle Heat System	Yes	Yes
Lint Screen	Internal	Internal
<b>DRYER CONTROLS</b>		
Temperature Settings	2	2
• Heavy High (heat)	Yes	Yes
• Permanent Press/ Heavy High (air)	Yes	-
• Timer Cycles	3	3
• Automatic Dry	Yes	Yes
• Permanent Press/ Reg.	Yes	Yes
• Timed Drying	Yes	Yes
• Fluff Air	Yes	Yes
<b>CONVENIENCE FEATURES</b>		
Side-Swing Door	Yes	Yes
End-of-Cycle Signal	Yes	-
DuraWhite™ Interior	Yes	Yes
<b>QUALITY FEATURES</b>		
Color Availability		
• White	Yes	Yes
Elec. Heating Element (Watts)	120V/1400W	220V/3000W
Gas Burner (BTUs)	N/A	N/A
Warranty**	1 Year	1 Year
Approx. Shipping Wt. (lbs.)		
• Electric	100	100
• Gas	N/A	N/A
Motor	1/4 HP	1/4 HP
Installed Cord	Elec. 6'	-

SPECIFICATIONS

### Compact Dimension

(all dimensions shown in inches)

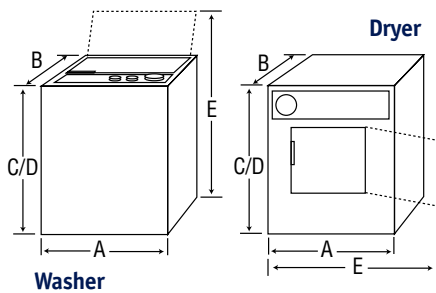

#### COMPACT WASHER MODELS

A-Width	B-Depth	C-Max	D-Top Height	E- Minimum Height w/Lid Open
22 1/2"	24"	35"	35"	49 1/4"

#### COMPACT DRYER MODEL

A-Width	B-Depth	C-Max Electric	D-Top Height	E- Depth with Door Open
23 7/8"	21 15/16"	32 1/2"	32"	37 3/16"

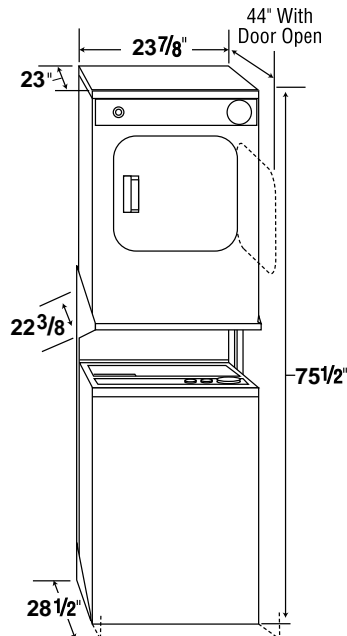

### COMPACT WASHER CASTER KITS

Stationary to Portable	Part No. 285768
Portable to Stationary	Part No. 285677

Compact Washer Model LCR7244H shown with optional Stack Stand Kit White 49971.



# WHIRLPOOL® WASHER & DRYER DIMENSIONS

WASHER DIMENSIONS					
	A	B	C	D	
	Width	Depth	Max Height	Top Height	Height w/Lid Open
EXTRA LARGE CAPACITY 24" MODELS	23 7/8"	25 1/2"	43"	36"	53"
EXTRA LARGE CAPACITY PLUS 27" MODELS SUPER CAPACITY PLUS MODELS	26 7/8"	25 1/2"	43"	36"	53"
ULTRA CAPACITY 27" MODELS	27"	26 1/2"	43 1/2"	36"	53"

DRYER DIMENSIONS						
	A	B	B	C	D	
	Width	Depth Electric	Depth Gas	Max Height	Top Height	Depth w/Door Open
EXTRA LARGE CAPACITY MODELS WITH REV. SIDE-SWING DOOR	29"	25 3/4"	26 1/2"	43"	36"	48 9/16" (electric) 48 15/16" (gas)
SUPER CAPACITY MODELS WITH WIDE-OPENING HAMPER DOOR	29"	27 5/8"	27 1/2"	43"	36"	50 1/4" (gas/electric)
SUPER CAPACITY PLUS MODELS WITH WIDE-OPENING HAMPER DOOR	29"	27 5/8"	28 1/2"	43"	36"	41 9/16" (electric) 41 15/16" (gas)
SUPER CAPACITY PLUS MODELS WITH SUPER REV. SIDE-SWING DOOR	29"	27 5/8"	28 1/2"	43"	36"	50 9/16" (electric) 50 15/16" (gas)
ULTRA CAPACITY MODELS WITH WIDE-OPENING HAMPER DOOR	27"	29 1/4"	29 1/4"	43"	36"	43 1/4" (gas/electric)
ULTRA CAPACITY MODELS (CALYPSO® STYLING) WITH WIDE-OPENING HAMPER DOOR	27"	30 1/4"	30 1/4"	43 1/2"	36"	43 1/4" (gas/electric)

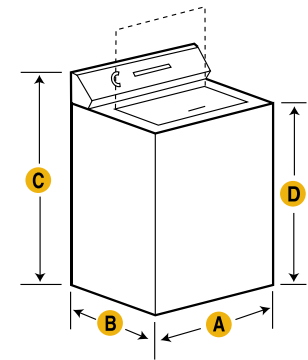

All Washers

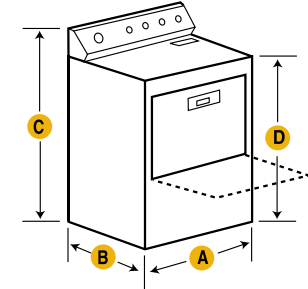

Dryers with a Wide-Opening Hamper Door

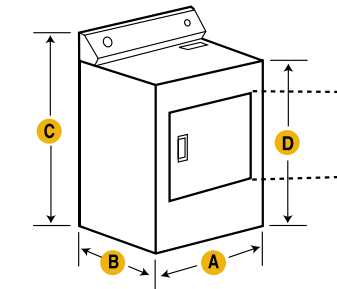

Dryers with a Reversible Side-Swing Door or a Super Reversible Side-Swing Door

# DUET® WASHER & DRYER DIMENSIONS

Washer Dimensions

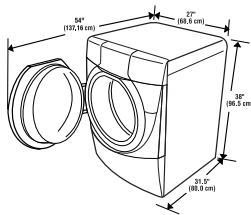

Dryer Dimensions

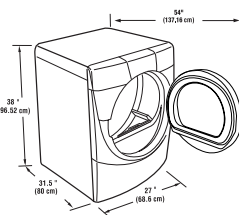

Closet Installation

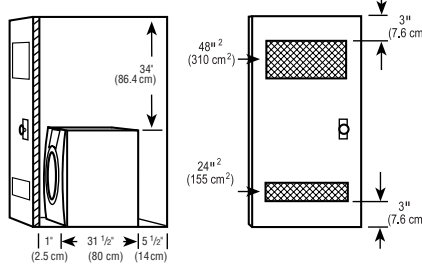

Recessed or Closet Installation with Pedestal

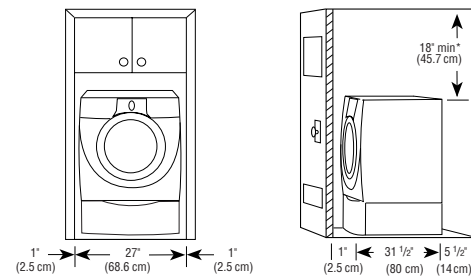

Installation with Stack Kit #8519492

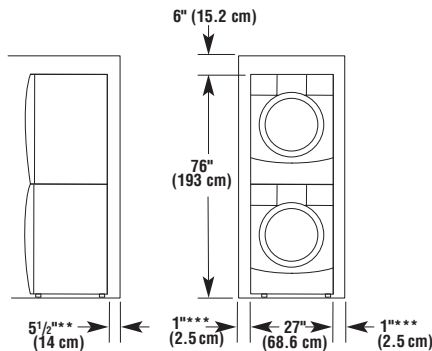

Custom Undercounter Installation

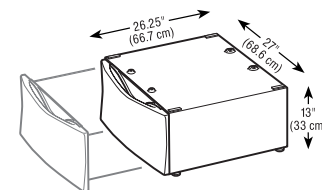
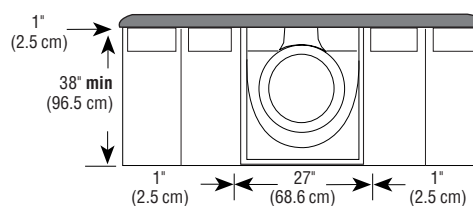

Optional Storage Drawer (Pedestal)  
Part No. LAB2700M

\*Min. top and bottom air openings for closet door. \*\*External exhaust elbow requires additional space. \*\*\*Wall, door and floor molding may require additional spacing.

# WHIRLPOOL® DRYER VENTING REQUIREMENTS

## 27" & 29" DRYER VENTING REQUIREMENTS

# of 90° turns	4" Hood	4" Hood	2 1/2" Hood	
0	64 Ft.	64 Ft.	58 Ft.	Maximum length of 4" diameter rigid metal duct
1	54 Ft.	54 Ft.	48 Ft.	
2	44 Ft.	44 Ft.	38 Ft.	
3	35 Ft.	35 Ft.	29 Ft.	
4	27 Ft.	27 Ft.	21 Ft.	
0	36 Ft.	36 Ft.	28 Ft.	Maximum length of 4" diameter flexible metal duct
1	31 Ft.	31 Ft.	23 Ft.	
2	27 Ft.	27 Ft.	19 Ft.	
3	25 Ft.	25 Ft.	17 Ft.	
4	23 Ft.	23 Ft.	15 Ft.	

### Exhaust Information

All dryers require the equivalent of a 4-inch diameter exhaust duct. Rigid metal duct is recommended. Failure to properly exhaust the dryer will result in improper operation.

## LP GAS CONVERSION KITS ARE AVAILABLE

24" Thin Twin® and Compacts	10,500 BTU	#694580
27" Thin Twin®	16,000 BTU	#3392235
Full-Size Gas Dryers	22,000 BTU	#49572

## OPTIONAL DRYER RACK

	Part No.
Extra Large Capacity (large side-swing only door)	689790
Super Capacity (side-swing or hamper door)	3404351
Super Capacity Plus (side-swing or hamper door)	3406839
Ultra-Capacity (hamper door only)	3406910

## MISCELLANEOUS ACCESSORIES

	Part No.
4' Drain Hose Extension	8318155
20" Drain Hose Extension	8318156
Drain Hose Adapter Kit	285835
2' Siphon Break Kit	285835

## 4-WAY VENTING FOR GE/GW9200L, GE/GW9868K AND GE/GQ9800L

The GE/GW9200L, GE/GW9868K & GE/GQ9800L offer 4-Way Venting Options.

4-Way Vent Kit Numbers:

White	279818
Biscuit	279925
Pewter	279969

To order parts and accessories, call a Whirlpool representative at 1-800-253-1301 or visit our website at [www.whirlpool.com](http://www.whirlpool.com).

## LE/GV4634J LONG VENT DRYER ONLY

# of 90° turns	4" Hood	4" Hood	2 1/2" Hood	
0	120 Ft.	120 Ft.	120 Ft.	Maximum length of 4" diameter rigid metal duct
1	119 Ft.	110 Ft.	110 Ft.	
2	100 Ft.	100 Ft.	100 Ft.	
3	90 Ft.	90 Ft.	90 Ft.	
4	80 Ft.	80 Ft.	80 Ft.	
5	70 Ft.	70 Ft.	70 Ft.	

The same length of vent can be used with any of the three exhaust hoods shown.

**Exhaust vent charts** list lengths by type of vent to be used. Use the chart that matches your vent type.

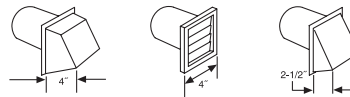

### When you use only one type of metal vent...

- Determine the number of elbows you will need.
- In the column listing the type of metal vent you are using (rigid or flexible), find the maximum length of metal vent on the same line as the number of elbows.

## MAXIMUM LENGTH OF RIGID METAL VENT OR FULLY EXTENDED FLEXIBLE METAL VENT (LE/GV4634J ONLY)

① Number of 90° elbows	① 4" dia. rigid metal vent	① 4" dia. flexible metal vent
0	120 Ft.	40 Ft.
1	110 Ft.	37 Ft.
2	100 Ft.	33 Ft.
3	90 Ft.	30 Ft.
4	80 Ft.	27 Ft.
5	70 Ft.	23 Ft.

The maximum length using a 2' x 6' rectangular vent with 2 elbows and transitioning into a 2-1/2' exhaust hood is 8 feet.

### When you use a combination of rigid and flexible metal vent...

- Determine the number of elbows you will need.
- Determine the length of **Flexible** metal vent you'll use. Find the column that has the nearest number of feet to what you will be using.
- In the shaded area of that column find the maximum length of **Rigid** metal vent on the same line as the number of elbows.

## MAXIMUM LENGTH OF FULLY EXTENDED FLEXIBLE AND RIGID METAL VENT (LE/GV4634J ONLY)

① # of 90° elbows	② length of Flexible metal vent						③ Length of Rigid metal vent
	0'	1-5'	6-10'	11-15'	16-20'	21-25'	
0	120 ft	105 ft	90 ft	75 ft	60 ft	45 ft	
1	110 ft	95 ft	80 ft	65 ft	50 ft	35 ft	
2	100 ft	85 ft	70 ft	55 ft	40 ft	25 ft	
3	90 ft	75 ft	60 ft	45 ft	30 ft	15 ft	
4	80 ft	65 ft	50 ft	35 ft	20 ft	5 ft	
5	70 ft	55 ft	40 ft	25 ft	10 ft	0 ft	

**Example:** ① You will need to use 2 elbows  
 ② You will use 5 feet **Flexible** metal vent  
 ③ The maximum length of **Rigid** metal vent you can use is 85 feet

# WHIRLPOOL® DRYER VENTING REQUIREMENTS

COMPACT VENTS			
# of 90° turns	4" Hood	4" Hood	2 1/2" Hood
0	43 Ft.	41 Ft.	36 Ft.
1	33 Ft.	31 Ft.	26 Ft.
2	23 Ft.	21 Ft.	16 Ft.
3	30 Ft.	29 Ft.	24 Ft.
4	24 Ft.	23 Ft.	18 Ft.
5	16 Ft.	15 Ft.	10 Ft.

Maximum length of 4" diameter rigid metal duct

## SURE CONNECT™ VENT KIT

Part #4396028

- Provides 4-1/2" clearance between dryer and wall
- Snap-Lock fittings
- Total kit length: 8 feet
- Additional vent can be snapped between sections for longer runs

### Kit Contains:

- 2 - 4' vent sections with attached close elbows
- 1 - Wall plate for close clearance installations
- 2 - 4" clamps

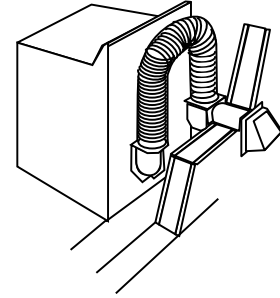

# WHIRLPOOL® WARRANTY INFORMATION

	LIFETIME LIMITED (PARTS ONLY)	10-YR. LIMITED (PARTS ONLY)	5-YR. LIMITED (PARTS ONLY)	2-YR. LIMITED (PARTS ONLY)	1-YR. FULL (PARTS AND LABOR)
Duet HT® and Duet® Washers	Stainless Steel Basket	Outer Tub	Porcelain and Powder Top, Drive Belt & Pulley	Electronic Control Boards	Entire Product
Calypso® Wash Motion Washer	Stainless Steel Basket	Outer Tub	Electronic Control Boards, Porcelain Top & Lid, Drive Belt & Pulley	-	Entire Product
Catalyst® Cleaning Action Washer	White Porcelain Wash Basket	Outer Tub	Electronic Control Boards, Porcelain Top & Lid Gearcase Assembly	-	Entire Product
Automatic Washers	White Porcelain Wash Baskets	Outer Tub	Gearcase Assembly, TOUGH-TOP II™, Porcelain Top & Lid	-	Entire Product
Thin Twin® Washer	White Porcelain Wash Baskets	Outer Tub	Gearcase Assembly, TOUGH-TOP II™	-	Entire Product
Duet® Dryer (GE/GW9200L)	-	-	Porcelain Top	Electronic Control Boards	Entire Product
Senseon™ Drying System Dryer (GEW9868K, GGW9868K, GEX9868J, GGX9868J, GEW9878L & GGW9878L)	-	-	Electronic Control Boards, Porcelain Top	-	Entire Product
Clothes Dryers	-	-	Porcelain Top	-	Entire Product
Thin Twin® Dryer	-	-	-	-	Entire Product

WARRANTY INFORMATION

## WHIRLPOOL® LAUNDRY APPLIANCES ARE PROTECTED BY LIBERAL WARRANTIES.

Refer to Use & Care Guide packed with product or ask your dealer for complete warranty details, including important warranty limitations and exclusions.

## WHIRLPOOL® SERVICE

A nationwide network of Whirlpool Brand Designated Service Contractors is available to provide both in-warranty and post-warranty service and maintenance. These specialists are experts in understanding Whirlpool® products and satisfying your service needs.

If you have questions regarding your Whirlpool® home appliances or want the name of your nearest Whirlpool Brand Designated Service Contractor, call:

**1-800-253-1301**

Or visit us at [www.whirlpool.com](http://www.whirlpool.com)





Call toll free: **1-800-253-1301**, 8-5pm EST for customer service and home economist advice.  
Authorized Whirlpool dealers may call **1-800-643-3444** for additional Whirlpool literature.



\*Euromonitor Brand Share Study 1999-2000.

TIDE is a registered trademark of The Procter & Gamble Company. The Woolmark symbol is a registered trademark of The Woolmark Company.

©Registered trademark/™Trademark of Whirlpool, U.S.A. ©2003 Whirlpool Corporation. All rights reserved. Form No. WWLL145. Printed in the U.S.A. 07/03