

# Vent Hood SPECIFICATION SHEET

EPT18, EPTH18, EPXT18, EPXTH18 Euroline Pro Wall Mount Models  
 NEPT18, NEPTH18, NEPXT18, NEPXTH18 Nouveau Euroline Pro Series  
 SEP18, SEPH18, SEPX18, SEPXH18 Euroline Pro with Emerald Lip  
 Note: "H" in part number indicates halogen lighting.

**EPT18/EPTH18** Euroline Pro  
**NEPT18/NEPTH18** Nouveau Euroline Pro  
**SEPT18/SEPTH18** With Emerald Lip

**EPXT18/EPXTH18** Euroline Pro  
**NEPXT18/NEPXTH18** Nouveau Euroline Pro  
**SEPXT18/SEPXTH18** With Emerald Lip

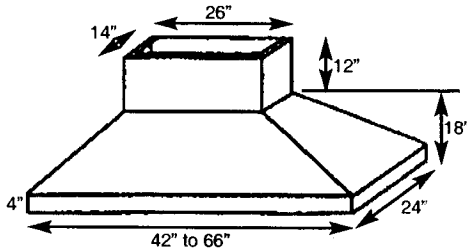

**Euroline Pro Lip**

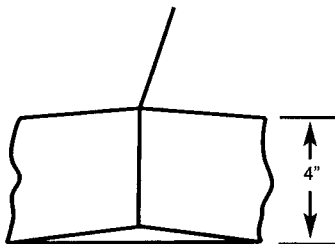

*Warning lights are not available with this model. Duct covers priced separately*

**Nouveau Euroline Pro Radius Lip**

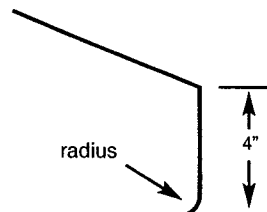

Side View

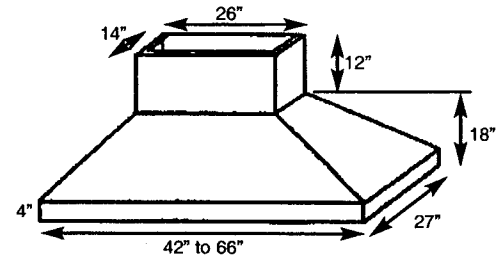

**Euroline Pro With Emerald Lip**

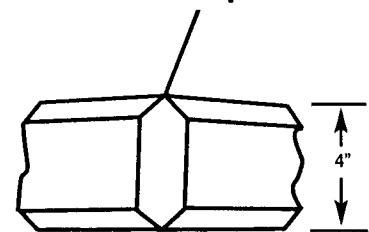

## ELECTRICAL/MECHANICAL SPECIFICATIONS FOR BLOWER UNITS

| Model       | Motor    | Type            | Volts | Amps | HZ | RPM  | CFM SP@0.0" | Equivalent CFM | CFM SP@0.1" | CFM SP@0.2" | CFM SP@0.3" | Minimum Round Duct Size | Square Inches |
|-------------|----------|-----------------|-------|------|----|------|-------------|----------------|-------------|-------------|-------------|-------------------------|---------------|
| B100 Single | 1/25     | Shaded Pole     | 115   | 1.7• | 60 | 1550 | 300         | 450            | 286         | 270         | 240         | 6" (or equivalent)      | 28            |
| B200 Dual   | (2) 1/25 | (2) Shaded Pole | 115   | 3.4• | 60 | 1550 | 600         | 900            | 572         | 540         | 480         | 8" (or equivalent)      | 50            |

• Note: Add 2.5 amps for each warming light and 1.0 additional amp for each halogen bulb. Equivalent CFM explained in the checklist on page 19 of literature.

**Lighting:** Hood is available with fluorescent light (1 for each single or dual blower) or with halogen lights - 24" to 41" - 2 lights, 42" to 53" - 3 lights, 54" to 66" - 4 lights, 66" + 1 light for each 16" of width. Warming lights are not available on these models.

The transition shown (VP557 & VP558) is installed in the hood at the factory as a standard item. It will be located in the exact center of the duct cover (left to right & front to rear).

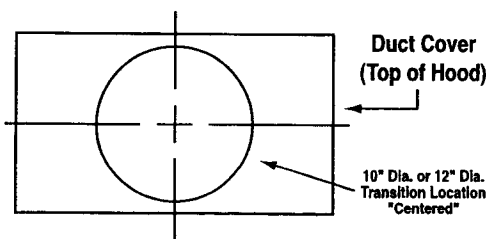

DUCT - 10" for Single B100 & Dual B200 and 12" for two Dual B200 Units

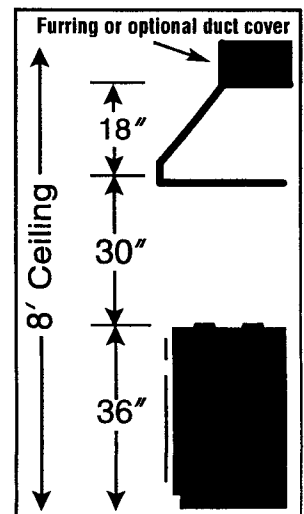
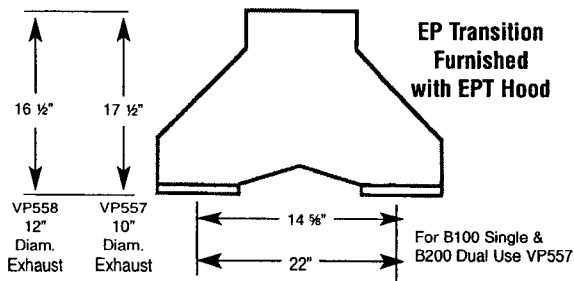

**SPECIFICATIONS SUBJECT TO CHANGE WITHOUT NOTICE.**