

LIEBHERR

Use and Care Manual

For NoFrost Combined
Refrigerator-Freezers

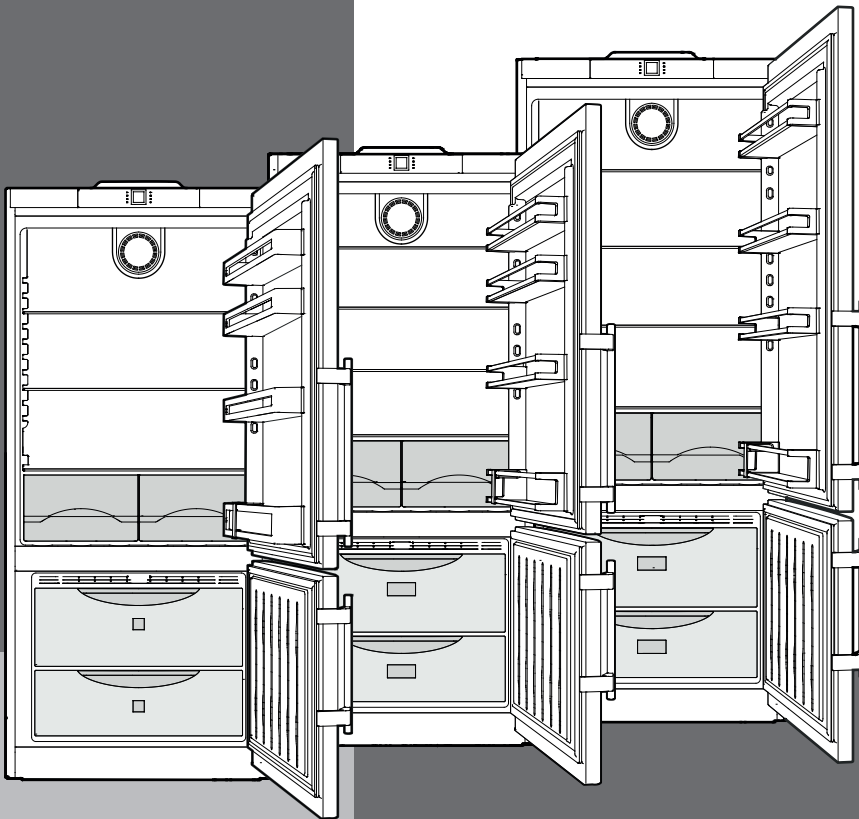

CS 1400 PC
CS 1400 R
CS 1410
7085 591-01

TABLE OF CONTENTS

Contents	Page
Please Read and Follow these Instructions	2
California Proposition 65.....	2
Disposal of Old Appliance	3
Disposal of this Appliance	3
R600a Refrigerant.....	3
Important Safety Information	4
Electrical Safety	5
Safety Regulations.....	5
Unit Dimensions.....	6
Description of Appliance and Equipment	6
Operating and Control Elements	7
Switching the Appliance On and Off	8
Temperature Display	8
Setting the Temperature	8
Ventilation.....	9
SuperCool	9
Audible Alarm Signal	9
Power Failure/FrostControl Display	9
Setup Mode.....	10
Arranging Food	11
Equipment	12
Interior Light	12
Freezing	13
Freezing with SuperFrost.....	13
Freezing and Storage.....	13
Defrosting.....	14
Cleaning	14
Vacation Tips	14
Customer Service	15

IMPORTANT

All types and models are subject to continuous improvement. The manufacturer reserves the right to make modifications to the shape, equipment and technology.

Please Read and Follow these Instructions

These instructions contain Danger, Warning and Caution notes.

This information is important for safe and efficient installation and operation.

Always read and comply with all Danger, Warning and Caution notes!



DANGER!

Danger indicates a hazard which will cause serious injury or death if precautions are not followed.



WARNING!

Warning indicates a potentially hazardous situation which, if not avoided, could result in death or serious injury.



CAUTION!

Caution indicates a potentially hazardous situation which, if not avoided, may result in minor or moderate injury.

IMPORTANT

This indicates information that is especially relevant to a problem-free installation and operation.

California Proposition 65

- This product contains chemicals known to the state of California to cause cancer or reproductive harm.
- This product can expose you to chemicals including Diisononyl Phthalate (DINP) which is known to the State of California to cause cancer. For more information go to www.P65Warnings.ca.gov.
- This product can expose you to chemicals including Di-isodecyl Phthalate (DIDP) which is known to the State of California to cause birth defects or other reproductive harm. For more information go to www.P65Warnings.ca.gov.

Disposal of Old Appliance



DANGER!

Risk of child entrapment.

Child entrapment and suffocation are not problems of the past.

Junked or abandoned refrigerators are still dangerous – even if they will sit for “just a few days.”

If you are getting rid of your old refrigerator, please follow these instructions to help prevent accidents.

Before you discard old appliances:

- Take off the doors.
- Leave the shelves in place so that children may not easily climb inside.
- Cut off the power cable from the discarded appliance. Discard separately from the appliance.
- Be sure to follow your local requirements for disposal of appliances.

Contact the trash collection agency in your area for additional information.

Disposal of this Appliance

This appliance contains flammable gases within the refrigeration circuit and insulation foam.

Contact the municipality or disposal company in your area for information on approved recycling or disposal.

R600a Refrigerant



WARNING!

The refrigerant R600a contained within the appliance is environmentally friendly, but flammable. Leaking refrigerant can ignite.

To prevent possible ignition, follow the warnings below:

- Keep ventilation openings, in the appliance enclosure or in the built-in structure, clear of obstruction. 
- Do not use mechanical devices or other means to accelerate the defrosting process, other than those recommended by the manufacturer.
- Do not damage the refrigerant circuit.
- Component parts and power cords shall be replaced with like components performed by factory authorized service personnel only.
- Do not use electrical appliances inside the food storage compartments of the appliance, unless they are of the type recommended by the manufacturer.

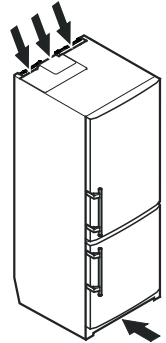

SAFETY

Important Safety Information

- To prevent injury to you or damage to the unit, the appliance should be unpacked and set up by two people.
- If the appliance is damaged on delivery, contact the supplier immediately before connecting to the power source.
- To guarantee safe operation, ensure that the appliance is set up and connected as described in these operating instructions.
- Disconnect the appliance from the power source if a fault occurs. Pull out the plug, turn off or remove the fuse.
- When disconnecting the appliance, use the plug. Do not pull on the cable.
- Any repairs and work on the appliance should only be carried out by the customer service department. Unauthorized work may be dangerous to the user. Changing the power source cable should only be done by the customer service department.
- Do not eat ice cream, particularly ice cream treats, or ice cubes, immediately from the freezer compartment. There is a risk of “burning” because of the very cold temperatures.
- Do not consume food which has been stored for too long; it could cause food poisoning.
- Do not store explosives or sprays using combustible propellants such as butane, propane, pentane, etc. in the appliance. Electrical components might cause leaking gas to ignite. You may identify such sprays by the printed contents or a flame symbol.
- To prevent possible injury due to an electrical shock, be sure to disconnect the power cord or turn off the circuit breaker before cleaning the appliance.
- To avoid injury or damage to the appliance, do not use steam cleaning equipment to clean the appliance.
- Do not operate the appliance in the presence of explosive fumes.
- In the event of a power outage, minimize opening the appliance door(s). Do not attempt to re-freeze any previously frozen food that has thawed.
- To protect the appliance from possible damage, allow the appliance to stand 1/2 to 1 hour in place before turning the electricity on. This allows the refrigerant and system lubrication to reach equilibrium.

Electrical Safety

Connect this appliance to a 15 amp or 20 amp, 110-120 VAC, circuit which is grounded and protected by a circuit breaker or fuse.

We recommend using a dedicated circuit for this appliance to prevent circuit overload and the chance of interruption to the appliance.

This appliance is equipped with a three-prong (grounding) polarized plug for your protection against possible shock hazards.

Where a two-prong wall receptacle is encountered, contact a qualified electrician and have it replaced with a properly grounded three-prong receptacle in accordance with all local codes and ordinances.



WARNING!

Electrocution hazard.

Electrical grounding required.

- Do not remove the round grounding prong from the plug. →

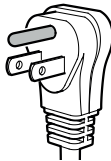

- Do not use extension cords or ungrounded (two-prong) adapters.
- Do not use a power cord that is frayed or damaged.

- Do not use a power strip. →

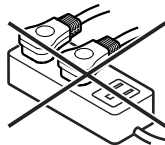

Failure to follow these instructions may result in fire, electrical shock or death.

Safety Regulations

The appliance is designed to cool, freeze and store food. It is designed as a household appliance.

IMPORTANT

The appliance is not intended for outdoor use.

The appliance is manufactured to operate within specific ambient temperature limits according to its climate rating.

The climate rating indicates the ambient temperature at which the appliance may be operated in order to achieve full refrigeration performance.

Climate Rating

SN-T

Ambient Temperature

50°F to 109°F (10°C to 43°C)

IMPORTANT

Do not operate the appliance outside the specified ambient temperature range.

- The refrigerant circuit has been tested for leaks.
- The appliance complies with current safety regulations

CAN/CSA C22.2 No.60335-1-11
UL 60335-1 Fifth Edition
CAN/CSA C22.2 No. 60335-2-24-06
UL 60335-2-24 First Edition

We recommend cleaning the appliance before turning it on for the first time. See **Cleaning**.

Turn on the appliance several hours before loading it.

Do not load with frozen food until the temperature shows approximately 0°F (-18°C).



WARNING!

Do not allow children to play with the appliance. Children must not climb, sit or stand on the racks or door.

Failure to follow these instructions may result in death or serious injury.

FEATURES

Unit Dimensions

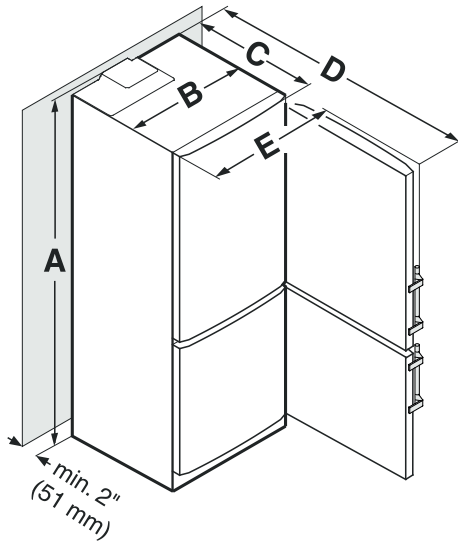

CS 1400 PC CS 1400 R

A = 66 5/16" (1684 mm)
 B = 29 7/16" (747 mm)
 C = 24 13/16" (630 mm)
 D = 52 5/16" (1328 mm)
 E = 30 5/8" (778 mm)

CS 1410

A = 73 13/16" (1859 mm)
 B = 29 7/16" (747 mm)
 C = 24 13/16" (630 mm)
 D = 52 5/16" (1328 mm)
 E = 30 5/8" (778 mm)

Clearance on the back must be 2 inch (51 mm).

NOTE

If the gap between the rear of the appliance and the wall is less than 2 inch (51 mm), the power consumption level may increase

Description of Appliance and Equipment

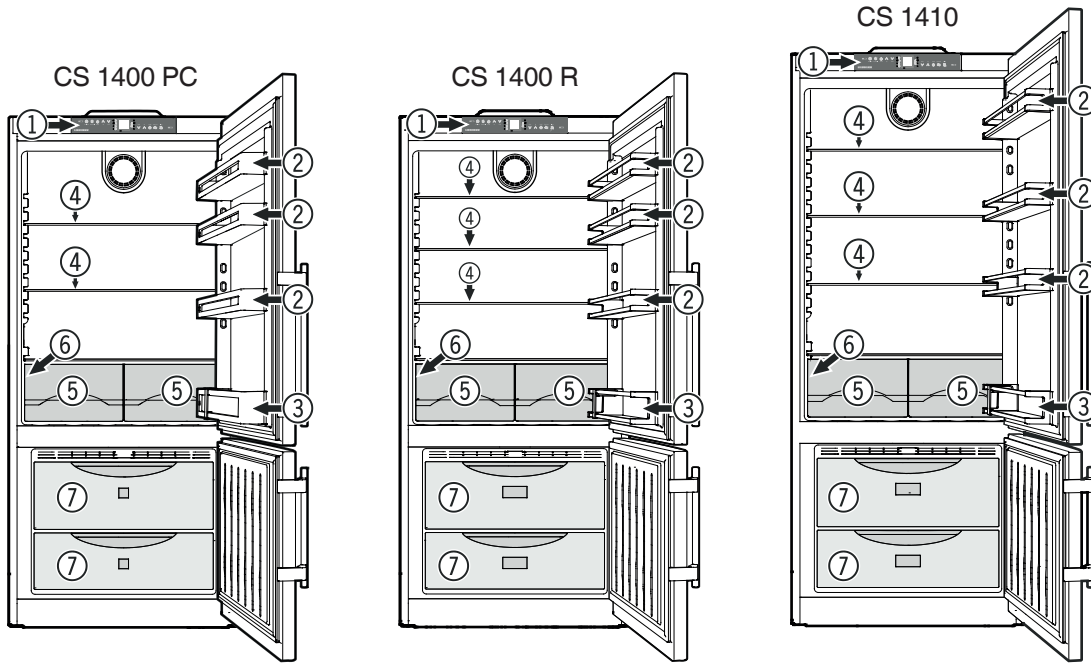

- (1) Operating and control elements
- (2) Adjustable door racks
- (3) Bottle rack
- (4) Adjustable shelves
- (5) Vegetable drawers
- (6) Model plate (behind the vegetable drawer on the left hand side)
- (7) Freezer drawers



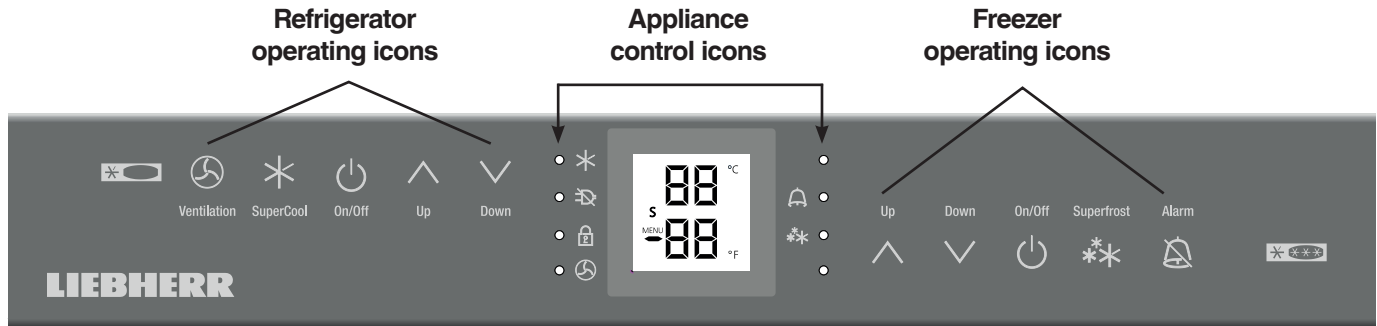

Operating and Control Elements

The electronic control panel has the Touch capacitance technology. Any function can be activated by a fingertip on the symbol of the operating icons.







The exact contact point is between the symbol and its label.







Refrigerator operating icons

-  Ventilation (circulation) On/Off
-  SuperCool
-  Refrigerator On/Off
-  Temperature Up control (to increase the refrigerator temperature)
-  Temperature Down control (to reduce the refrigerator temperature)

Appliance control icons

-  Power failure LED
-  SuperCool LED
-  Child lock LED
-  Alarm LED
-  SuperFrost LED
-  Ventilation ON LED

Freezer operating icons

-  Temperature Up control (to increase the freezer temperature)
-  Temperature Down control (to reduce the freezer temperature)
-  Freezer On/Off
-  SuperFrost
-  Alarm mute (refrigerator and freezer)

Temperature and control display

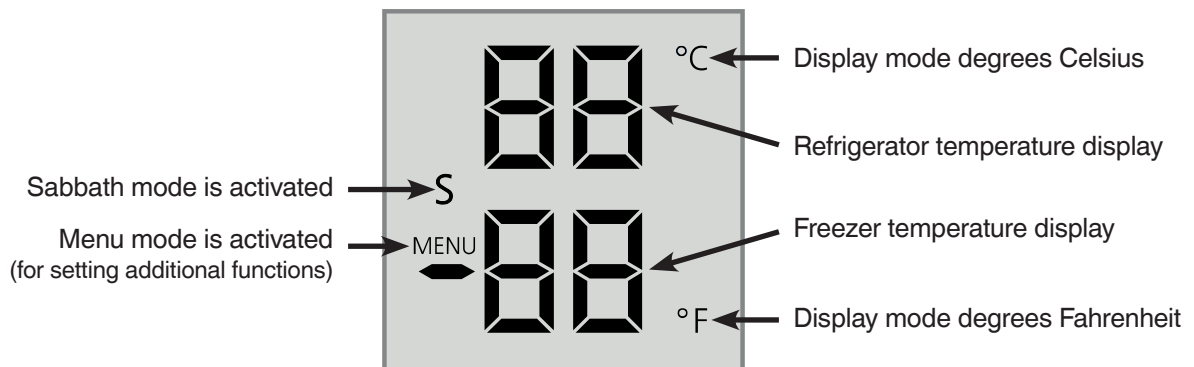

OPERATION

Switching the Appliance On and Off

Clean the appliance before turning it on for the first time. See **Cleaning**.

Do not place frozen food in the freezer until the temperature shows at least 0°F (-18°C).

Switching the appliance on

Touch the Refrigerator On/Off icon or the Freezer On/Off icon so the temperature displays light up.

Switching the refrigerator compartment off

Touch the Refrigerator On/Off icon for approximately 3 seconds.

Note

If the freezer compartment is switched off, the entire appliance will be switched off.

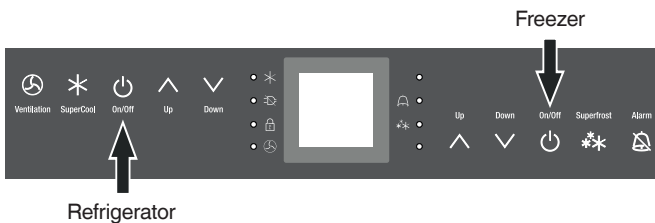

Temperature Display

In normal operation, the following settings will be displayed:

- the average refrigerator temperature
- the warmest frozen food temperature.

When starting up for the first time or when the appliance is warm, dashes will appear in the freezer temperature display, until the temperature in the freezer compartment is 32°F (0°C).

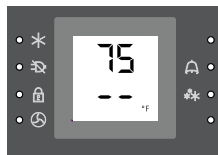

The display will flash:

- if you change the temperature or
- if the temperature rises by several degrees, indicating cold loss, e.g. if you place fresh, "warm" food in the freezer or if you remove or repack frozen food, the temperature may rise for a short time due to warm air flowing into the freezer.

Setting the Temperature

The appliance is pre-set for normal operation. We recommend temperatures of 38°F (3°C) in the refrigerator and 0°F (-18°C) in the freezer.

To reduce the temperature

Touch the **Down** icon on the left to reduce the refrigerator temperature and the **Down** icon on the right to reduce the freezer temperature.

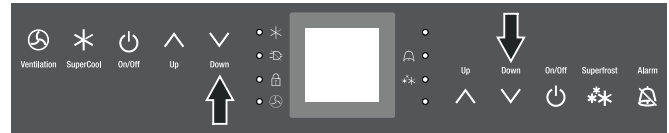

To increase the temperature:

Touch the **Up** icon on the left to increase the refrigerator temperature and on the right to increase the freezer temperature.

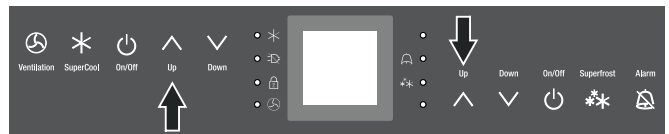

- While you are entering the temperature, the set temperature will flash on the display.
- When you touch the temperature setting icons for the first time, the most recent setting is displayed.
- You can change the settings in increments of 1°F (1°C) by briefly touching the icons again. If the icons are held, the temperature setting will change faster.
- Approximately five seconds after the icon has been released, the display will automatically show the actual freezing or cooling temperature.

You can change the temperatures:

In the refrigerator between 36°F and 45°F (2°C and 7°C) and in the freezer between -15°F and 7°F (-27°C and -14°C).

Ventilation

The Ventilation switch is used for re-circulated cool air.

You can use the switch as required to:

- chill large quantities of fresh food fast.
- keep the temperature evenly distributed throughout the entire refrigerator compartment. The air will circulate more intensively, keeping all the different areas in the compartment at the same temperature and ensuring all the food inside is chilled at the same temperature.

We recommended you use the ventilation fan if:

- room temperatures are too high (approximately 95°F [35°C] or higher).
- the air humidity is high, during high heat and humidity.

Turning on

Touch the Ventilation icon briefly so the LED  turns on.

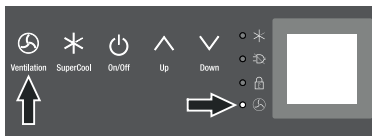

Turning off

Touch the Ventilation icon again until the LED  turns off.

SuperCool

It is recommended particularly if you wish to cool large quantities of food, drinks, freshly baked goods or meals rapidly.

Turning on

Touch the SuperCool icon briefly so the LED  turns on. The refrigerator temperature will drop to its lowest value.

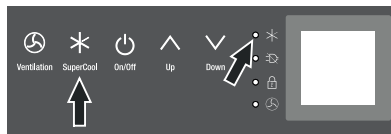

IMPORTANT

The SuperCool function uses slightly more energy. After approximately six hours, however, the refrigerator switches back automatically to normal energy-saving operation. If required, the SuperCool function can be turned off sooner.

Turning off

Touch the SuperCool icon again until the LED  turns off.

Audible Alarm Signal

The audible alarm signal is switched off by touching the alarm icon.

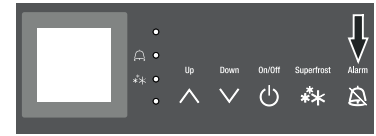

Audible door alarm

This sounds when the door has been left open for longer than about 180 seconds. The sound switch-off function is active as long as the door is left open. The alarm automatically switches back to standby when the door is shut.

Audible/visual temperature alarm

It always sounds if the freezer temperature is not low enough. The temperature display and the alarm LED  flash at the same time.

This can be caused by:

- warm, fresh food being placed in the freezer,
- too much warm air from the outside entering when re-arranging or removing frozen food,
- a fault in the appliance.

The temperature display will continue to flash until the cause of the alarm has been rectified. It will then stop flashing and light up continually. The audible warning signal is now automatically reset.

Power Failure/FrostControl Display

If the power failure LED  is lit, this means the freezer temperature has risen too **high** during the last few hours or days due to a power failure. The freezer temperature display flashes at the same time.

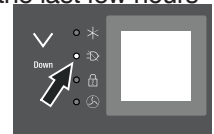

- If you touch the **Alarm** icon now, the highest temperature registered during the power failure will be displayed.
- Check the quality of the food in case it has become too warm or even defrosted.
- The highest temperature will appear for approximately one minute. After that, the actual temperature in the freezer will reappear.

The display can be turned off by touching the **Alarm** icon again.

OPERATION

Setup Mode



In the setup mode, you can activate the following functions:

= Sabbath mode

This feature considers the religious requirements on the Sabbath or holidays. When the Sabbath mode is active, some functions of the electronic controls are switched off.



- The lighting remains off.
- The cooling fan remains in its actual state: If it is on, it remains on, if it is off, it remains off.
- There is no door alarm.
- There is no temperature alarm.

Activating the Sabbath mode

- Activate the setup mode by touching the **SuperFrost** icon for 5 seconds.
 - the display shows 
- Touch the **SuperFrost** icon
 - the display shows 
- Touch the **SuperFrost** icon again
 - the display shows 
 - the Sabbath mode is activated.
- Exit setup mode by touching the freezer compartment **On/Off** icon.







Sabbath mode switches off automatically after 120 hours if it is not manually switched off beforehand.

Deactivating the Sabbath mode

- Activate the setup mode by touching the **SuperFrost** icon for 5 seconds.
 - the display shows 
- Touch the **SuperFrost** icon
 - the display shows 
- Touch the **SuperFrost** icon again
 - the display shows 
 - the Sabbath mode is deactivated.
- Exit setup mode by touching the freezer compartment **On/Off** icon.

= Display brightness



Adjusting the display brightness

- Activate the setup mode by touching the **SuperFrost** icon for 5 seconds.
- Touch the **freezer compartment Down** icon until  appears in the freezer temperature display.
- Touch the **SuperFrost** icon
 - the display shows 
- Touch **freezer compartment Up/Down** icons to select
 -   = minimum to
 -   = maximum brightness
- Touch the **SuperFrost** icon at the desired value.
- Exit setup mode by touching the freezer compartment **On/Off** icon.
- Close the appliance door. The adjusted brightness will be activated after one minute.

= Temperature display mode

You can choose the **unit of temperature** for the display in degrees Fahrenheit or degrees Celsius.

The factory setting is degrees Fahrenheit.

- Activate the setup mode by touching the **SuperFrost** icon for 5 seconds.
- Touch the **freezer compartment Down** icon until  appears in the freezer temperature display.
- Touch the **SuperFrost** icon
 - the display shows 
- Touch the **SuperFrost** icon again
 - the temperature reading is now displayed in degree Celsius.
- Exit setup mode by touching the freezer compartment **On/Off** icon.
- To change the temperature display back to degrees Fahrenheit, follow the steps above.

Arranging Food



☒ = Child lock

The child lock is designed to protect the appliance from being switched off and the temperature setting from being changed accidentally.

Activating the child lock

- Activate the setup mode by touching the **SuperFrost** icon for 5 seconds.
- Touch the **freezer compartment Down** icon until ☒ appears in the freezer temperature display.
- Touch the **SuperFrost** icon
 - the display shows ^{mm} ☒ |
- Touch the **SuperFrost** icon again
 - the LED  is lit and the child lock is activated.
- Exit setup mode by touching the freezer compartment **On/Off** icon.

Deactivating the child lock

- Activate the setup mode by touching the **SuperFrost** icon for 5 seconds.
- Touch the **freezer compartment Down** icon until ☒ appears in the freezer temperature display.
- Touch the **SuperFrost** icon
 - the display shows ^{mm} ☒ 
- Touch the **SuperFrost** icon again
 - the LED  goes out. The child lock is deactivated.
- Exit setup mode by touching the freezer compartment **On/Off** icon.

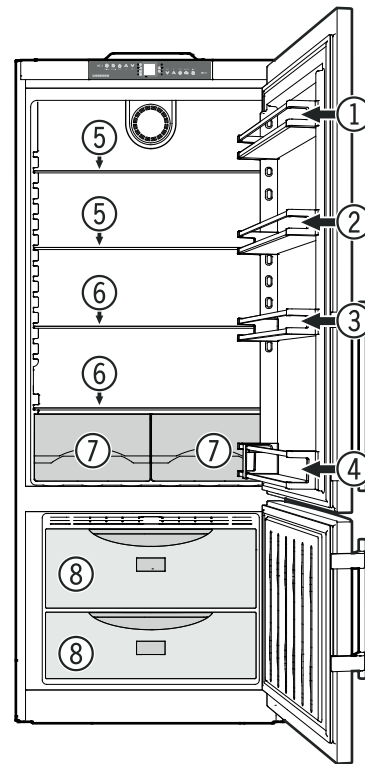

- (1) Butter, cheese
- (2) Eggs
- (3) Cans, drinks
- (4) Bottles
- (5) Baked goods, pre-cooked meals
- (6) Meat and sausage products, dairy products
- (7) Fruit, vegetables, salad
- (8) Frozen food

IMPORTANT

- Liquids and food which give off or absorb odors and flavors should always be stored covered or in closed containers.
- High-percentage alcohols should be tightly sealed and stored upright.
- Fruit, vegetables and salad can be stored unpacked in the vegetable drawers.

REFRIGERATOR COMPARTMENT

Equipment

You can rearrange the height of the shelves and door racks as required.



CAUTION!

Risk of injury and damage.

Only adjust an empty shelf or door rack.

Do not attempt to adjust a shelf or door rack with food on it.

Repositioning the shelves

Hold the shelf underneath with your hand to avoid from tipping down backwards when removing.

Lift the shelf at the front.

1. Remove the shelf forward until the circular cutout of the shelf is in line with the front supports.
2. Lift the shelf up or down and replace in the desired position.

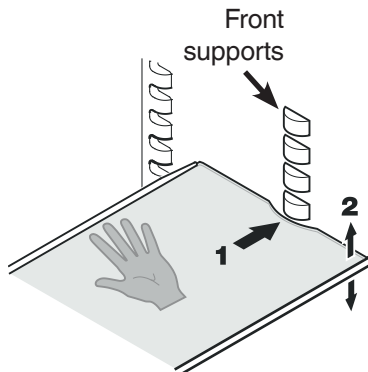

Removing the shelves

Open the door as far as possible.

1. Lift the shelf at the front.
2. Remove the shelf forward.

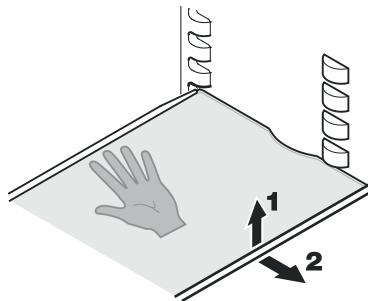

Sectioned shelf

(CS 1400 R, CS 1410 only)

If you need to make space for tall containers, simply slide the front half of the sectioned glass shelf carefully underneath the back half.

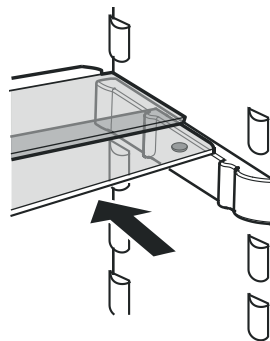

Repositioning the sectioned shelf

Place the shelf rails provided on the supports on the left and right at the desired height

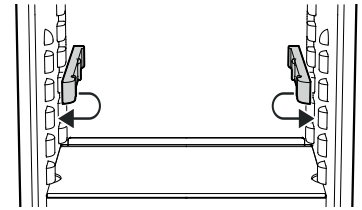

Repositioning the door racks

Slide the door rack up, pull out toward you and replace in reverse order.

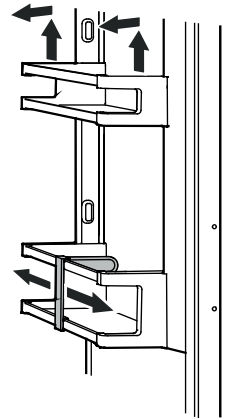

Bottle holder

You can protect the bottles from falling over when the door is opened and closed.

Move the bottle holder to the desired position. Always hold at the front for moving.

Interior Light

The light is located behind the cover located at the top of the refrigerator compartment.

The light intensity of the LED light corresponds to laser class 1/1M.

IMPORTANT

The light cover may only be removed by customer service staff.



CAUTION!

Risk of eye damage.

If the cover is removed, do not look directly at the light through optical lenses from a close distance.

Freezing

Fresh food should be frozen completely and as rapidly as possible. This is provided by the SuperFrost feature and ensures that the nutritional value, appearance and flavor of the food remains intact.

Freezing with SuperFrost

- Touch the **SuperFrost** icon briefly so the LED ** turns on.

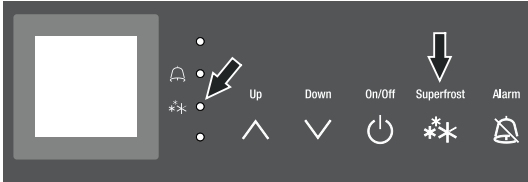

- Wait 24 hours.
- Then place the fresh food inside the freezer.
- The SuperFrost function turns off automatically. Depending on the quantity of food placed in the freezer, this will normally be between 30 and maximum 65 hours.

The freezing process is now complete; the SuperFrost LED ** will turn off, and the freezer will change back to normal energy-saving operation.

You should not turn on the SuperFrost function:

- when placing frozen food in the freezer;
- when freezing up to approximately 4-1/2 lbs (2 kg) fresh food daily.

Freezing and Storage

- Pack frozen food in standard freezer bags or reusable plastic, metal or aluminum containers.
- Do not allow fresh food which is to be frozen to come into contact with food already frozen. Always keep packages dry in order to avoid them sticking together.
- Always write the date and contents on the package and do not exceed the stated storage time for the food. This prevents spoiling.
- Pack food which you are freezing yourself in quantities right for your household. To ensure the food freezes right through quickly, the following quantities should not be exceeded per package:
 - fruit, vegetables: up to 2-1/4 lbs (1 kg);
 - meat: up to 5-1/2 lbs (2.5 kg).
- Do not freeze bottles and cans which contain carbonated drinks as they might burst. Drinks can be cooled down quickly, but take the bottles out of the freezer compartment after an hour at the most.
- Only take out as much food as needed for thawing. Cook food which has been thawed as quickly as possible. Frozen food can be thawed in the following ways:
 - in a microwave oven
 - in the refrigerator: the safer way to thaw food because there is less chance of bacteria growth. Use this method for high density food such as roasts or poultry.

Defrosting

Refrigerator compartment

The refrigerator compartment defrosts automatically. The water that forms on the rear wall drains into a reservoir at the back of the appliance and evaporates automatically through the compressor heat.

Freezer compartment

The NoFrost system automatically defrosts the freezer compartment. Any moisture will collect on the evaporator and freeze. It will periodically defrost and evaporate.

Cleaning



WARNING!

- **To prevent possible injury due to an electrical shock, be sure to disconnect the power cord or turn off the circuit breaker before cleaning the appliance.**
- **To avoid injury or damage, do not use steam cleaning equipment to clean the appliance.**
- **To avoid short-circuits, ensure no cleaning water penetrates into the electrical components when cleaning the appliance. Do not use a sponge or cloth that is overly wet.**
- Clean the side panels and door surfaces with a clean and soft cloth. If necessary, use a moist cloth (water + detergent). Alternatively, use a micro-fibre cloth.

Do not use abrasive or scouring sponges. Do not use concentrated cleaning agents. Never use abrasive or acid cleaners or chemical solvents.

- Remove all food from the refrigerator and freezer compartments and store in a cool place temporarily. Store frozen food in other freezers if available.
- Remove the door racks.
- Remove glass shelves.
- Remove vegetable drawers.
- Clean the equipment parts by hand with lukewarm water and dishwasher detergent.
- Clean the refrigerator and freezer drawers' interior with lukewarm water and dishwasher detergent.
- Dry all parts well with a cloth.
- **Do not** damage or remove the model plate on the inside of the appliance. It is very important for servicing your appliance.

Vacation Tips

Short vacations

It is not necessary to turn off the refrigerator and freezer if you will be away for less than four weeks.

- Use all perishables.
- Freeze other items.

Long vacations

If you will be away for a month or more:

- Remove all food from the refrigerator and freezer compartments.
- Turn off the refrigerator and freezer compartments.
- Clean the appliance. Refer to **Cleaning**.
- Leave the door open to prevent unpleasant odors. This will also keep mold from building up.

Your appliance is designed and manufactured for a long life and reliable operation.

If a problem occurs during operation, check whether it is due to an operating error.

Please note that even during the warranty period, you may be responsible for certain repair costs.

Problem	Possible Cause and Remedy
Appliance does not work, display is off	<ul style="list-style-type: none"> - Is the appliance turned on properly? - Is the power cord properly inserted in the outlet? - Is the circuit breaker or fuse in operating condition?
The interior light does not come on	<ul style="list-style-type: none"> - Is the refrigerator compartment turned on? - Has the door been open for more than 15 minutes?
Loud running noise	<ul style="list-style-type: none"> - Is the appliance standing firmly on the floor, or does the compressor cause nearby items of furniture or objects to vibrate? If necessary, move the appliance slightly, align by adjusting the adjustable feet, or adjust bottles and containers.
Motor seems to run too long	<ul style="list-style-type: none"> - Is the ambient temperature too hot? See Safety Regulations. - Has the appliance been opened too often or left open too long? - A large amount of food has been added. - Unit is in SuperCool mode. Verify unit is in normal operation mode.
The temperature is not cold enough	<ul style="list-style-type: none"> - Is the temperature setting correct? See Setting the Temperature. - Has an excessive amount of fresh food been placed in the appliance? - Does a separately installed thermometer show the correct reading? - Is the ventilation system working properly? - Is the appliance set up too close to a heat source?
Freezer temperature display shows two dashes - -	The freezer temperature display will only show temperatures that are below freezing. When initially starting the freezer it will not be below freezing. It will take three to five hours (depending on ambient conditions) for freezing temperatures to be achieved and thus displayed numerically. This may also occur after a power failure.

Customer Service

If none of the above possible causes apply, and you can not rectify the fault yourself, contact the Liebherr Service Center. Indicate the type **(1)** of appliance, service number **(2)** and the appliance / serial number **(3)** as shown on the model plate.

The position of the model plate is shown in the section entitled **Description of the Appliance**.

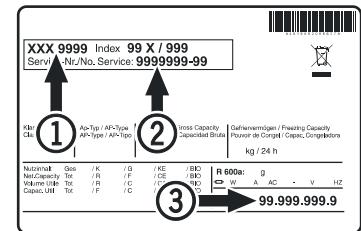

For Service in the U.S.

Liebherr Service Center

Toll Free: **1-866-LIEBHER** or **1-866-543-2437**

Email: Service-appliances.us@liebherr.com

PlusOne Solutions, Inc.

3501 Quadrangle Blvd, Suite 120

Orlando, FL 32817

For Service in Canada

Liebherr Service Center

Toll Free: **1-888-LIEBHER** or **1-888-543-2437**

www.euro-parts.ca

EURO-PARTS CANADA

39822 Belgrave Road

Belgrave, Ontario, N0G 1E0

Phone: (519) 357-3320

Fax: (519) 357-1326



www.liebherr-appliances.com