

# NX58R6631SS

SAMSUNG

## 5.8 cu. ft. Freestanding Gas Range with True Convection



### Signature Features

#### Blue LED Illuminated Knobs

- Visually lets you know if your cooktop is on from a distance



#### Powerful/Flexible Cooktop

- Flexible cooktop cooks faster with 5 specialized burners, including 18K BTU and 16K BTU power burners and one 5K simmer burner

#### True Convection

- Cook food faster and more evenly with a heated fan system that is great for baking and broiling

### Available Colors

-  Stainless Steel (shown)
-  Fingerprint Resistant Black Stainless Steel
-  Fingerprint Resistant Tuscan Stainless Steel



Blue LED Illuminated Knobs

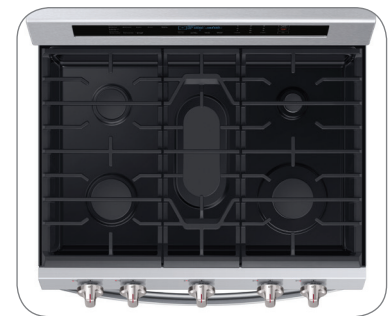

Powerful, Flexible Cooktop

### Features

- Blue LED Illuminated Knobs
- Powerful, Flexible Cooktop – 5 Gas Burners
  - Right Front: 18K BTU
  - Left Front: 16K BTU
  - Right Rear: 5K BTU
  - Left Rear: 9.5K BTU
  - Center: 10K BTU (Oval)
- True Convection Oven
- Large Oven Capacity – 5.8 cu. ft.
- Touch Controls
- Wide View Window
- Cast Iron 3-Piece Grates
- Storage Drawer
- Flat Handle

### Convenience

- Self Clean
- 3 Easy Cook Presets
- Auto Oven Light
- Proofing
- Sabbath Mode
- Kitchen Timer
- Delay Start
- Auto Shut-Off Option
- Child Safety Lock

# NX58R6631SS

**SAMSUNG**

## 5.8 cu. ft. Freestanding Gas Range with True Convection

### Product Dimensions

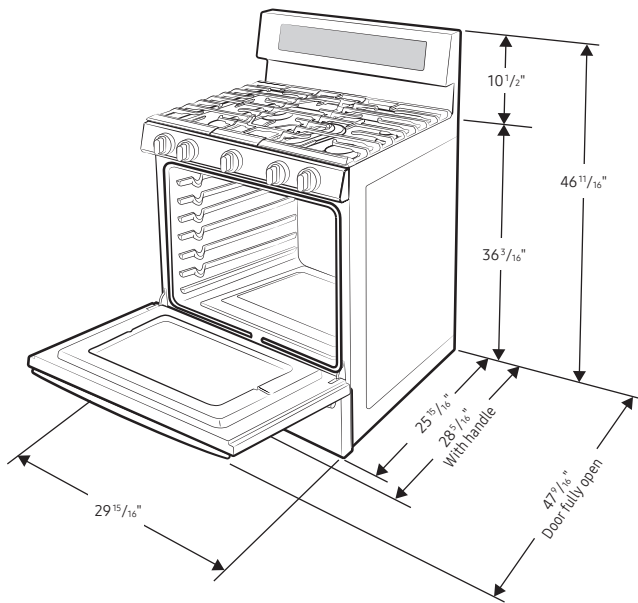

### Total Power

58.5K BTU

### Power Source

120V/60Hz/20A

### Black Enamel 5-Burner Cooktop

- Right Front: 18K BTU
- Left Front: 16K BTU
- Right Rear: 5K BTU
- Left Rear: 9.5K BTU
- Center (Oval): 10K BTU

### Oven: 5.8 cu. ft. Capacity

- Bake: 175°F–550°F
- Convection Bake: 175°F–550°F
- Bake Burner: 18K BTU
- Broil Burner: 13.5K BTU
- Variable Broil: Low/Hi (375°F–480°F)
- Convection Roast: 175°F–550°F
- Proofing
- Sabbath Mode

### Installing Your Range

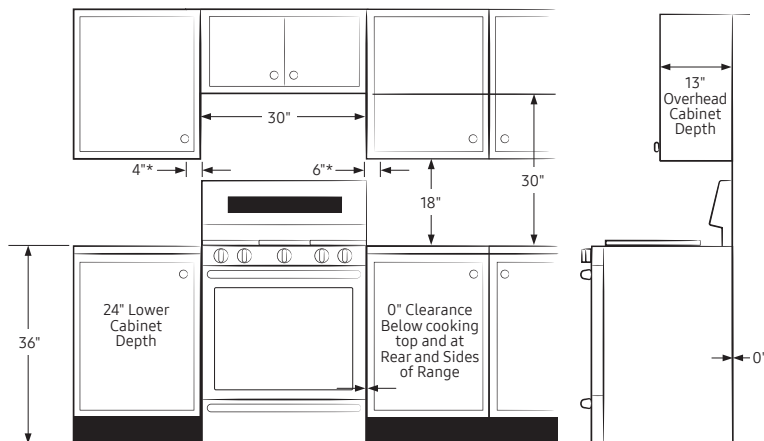

\* Side clearance above cooking surface to any objects, i.e., wall

**IMPORTANT:** Consult with Installation Manual for detailed instructions before installing. All ranges must be installed with the Anti-Tip device that is included.

### Recommended Locations for Gas Piping and Electrical Outlets

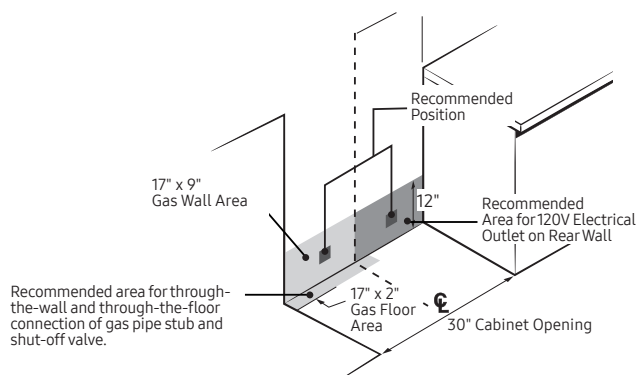

### Storage Drawer

Capacity: 0.7 cu. ft.

### Warranty

One (1) Year Parts and Labor

### Product Dimensions & Weight (WxHxD)

Actual Oven Dimensions:  
25" x 19" x 21 1/8"

Outside Net Dimensions:  
29 15/16" x 46 11/16" x 28 5/16"

Weight: 200 lbs

### Shipping Dimensions & Weight (WxHxD)

Dimensions:  
33 1/16" x 50 5/8" x 30 5/16"

Weight: 227 lbs

### Color

Stainless Steel

### Model #

NX58R6631SS

### UPC Code

887276226941

Fingerprint Resistant  
Black Stainless Steel

NX58R6631SG

887276226934

Fingerprint Resistant  
Tuscan Stainless Steel

NX58R6631ST

887276314037

Actual color may vary. Design, specifications, and color availability are subject to change without notice. Non-metric weights and measurements are approximate.

©2019 Samsung Electronics America, Inc. 85 Challenger Road, Ridgefield Park, NJ 07660. Tel: 800-SAMSUNG. samsung.com. Samsung is a registered trademark of Samsung Electronics Co., Ltd.