



[WWW.KUCHT.COM](http://WWW.KUCHT.COM)



**PRO** IN YOUR KITCHEN

KUCHT  
**REFRIGERATOR - FREEZER**  
INSTRUCTION MANUAL

APPLICABLE MODEL: **KR700i**

# TABLE OF CONTENTS

<b>IMPORTANT SAFETY INSTRUCTIONS</b> .....	2
<b>ENVIRONMENTAL PROTECTION</b> .....	5
<b>INSTALL INSTRUCTION</b> .....	6
Leveling feet .....	7
Adjustment of cantilever rack .....	7
Disassembly of freezer drawer .....	7
Installing the water line .....	8
Leveling doors .....	9
Changing the light .....	9
Moving the appliance .....	9
Tips for energy saving .....	9
<b>PRODUCT OVERVIEW</b> .....	10
Parts and functions .....	10
<b>OPERATION INSTRUCTIONS</b> .....	12
Use and functions .....	12
Storing food .....	14
<b>MAINTENANCE AND CLEANING</b> .....	15
<b>TROUBLESHOOTING</b> .....	17







## WARNING NOTICES

Before using this product, please read this manual carefully and keep it for future reference. The design and specifications are subject to change without prior notice for product improvement. Consult with your dealer or manufacturer for details. The diagram above is just for reference. Please take the appearance of the actual product as the standard.

## BEFORE SWITCHING ON THE APPLIANCE FOR THE FIRST TIME READ THE FOLLOWING SAFETY HINTS!

- This appliance is intended to be used in household and similar applications such as staff kitchen areas in shops, offices and other working environments; farm houses and by clients in hotels, motels and other residential type environments; bed and breakfast type environments; catering and similar non-retail applications.
- This appliance is not intended for use by persons (including children) with reduced physical, sensory or mental capabilities, or lack of experience and knowledge, unless they have been given supervision or instruction concerning use of the appliance by a person responsible for their safety.

## EXPLANATION OF TERMS/SYMBOLS

	<b>DANGER</b> This symbol indicates that there are dangers to the life and health of persons due to extremely flammable gas.
	<b>WARNING</b> The signal word indicates a hazard with a medium level of risk which, if not avoided, may result in death or serious injury.
	<b>CAUTION</b> The signal word indicates a hazard with a low degree of risk which, if not avoided, may result in minor or moderate injury.
	<b>ATTENTION</b> The signal word indicates important information (e.g. damage to property), but not danger.

- **IMPORTANT:**

Pay particular attention to messages that contain the words **DANGER, WARNING** or **CAUTION**. These words are used to alert you to a potential hazard that can seriously injure you and others. The instructions will tell you how to reduce the chance of injury and let you know what can happen if the instructions are not followed.

- **ATTENTION:**

These operating instructions are general. This means that certain functions apply to your refrigerator/freezer, while others do not. We are constantly working on the further development and improvement of our appliance types and models. Therefore, we reserve the right to make changes to the design, equipment and accessories of all types and models without prior notice.

# IMPORTANT SAFETY INSTRUCTIONS

## READ AND SAVE THESE INSTRUCTIONS!



### **WARNING: Risk of fire / Flammable material**

Refrigerant and cyclopentane foaming material used for the appliance are flammable. Therefore, when the appliance is scrapped, it shall be kept away from any fire source and be recovered by a special recovering company with corresponding qualification other than be disposed by combustion, so as to prevent damage to the environment or any other harm.

## **WARNING**

### **GENERAL SAFETY**

- Children should be supervised to ensure that they do not play with the appliance.
- If the supply cord is damaged, it must be replaced by the manufacturer, its service agent or similarly qualified persons in order to avoid a hazard.
- Do not store explosive substances such as aerosol cans with a flammable propellant in this appliance.
- The appliance has to be unplugged after use and before carrying out user maintenance on the appliance.
- **WARNING:** Keep ventilation openings, in the appliance enclosure or in the built-in structure, clear of obstruction.
- **WARNING:** Do not use mechanical devices or other means to accelerate the defrosting process, other than those recommended by the manufacturer.
- **WARNING:** Do not damage the refrigerant circuit.
- **WARNING:** Do not use electrical appliances inside the food storage compartments of the appliance, unless they are of the type recommended by the manufacturer.
- **WARNING:** Please abandon the refrigerator according to local regulators for its use of flammable blowing gas and refrigerant.
- **WARNING:** When positioning the appliance, ensure the supply cord is not trapped or damaged.
- **WARNING:** Do not locate multiple portable socket-outlets or portable power supplies at the rear of the appliance.
- Do not use extension cords or ungrounded (two prong) adapters.
- To avoid a hazard due to instability of the appliance, it must be fixed in accordance with the instructions.
- The refrigerator must be disconnected from the source of electrical supply before attempting the installation of accessory. Ensure that the power cable is not trapped by the refrigerator. Do not step on the power cable.
- For a freestanding appliance: This refrigerating appliance is not intended to be used as a built-in appliance.

## CAUTION

### DAILY USE

- Do not pull the power cord when pulling the power plug of the refrigerator. Please firmly grasp the plug and pull out it from the socket directly.
- To ensure safe use, do not damage the power cord or use the power cord when it is damaged or worn.
- Please use a dedicated power socket and the power socket shall not be shared with other electrical appliances.
- The power plug should be firmly contacted with the socket or else fires might be caused.
- Please ensure that the grounding electrode of the power socket is equipped with a reliable grounding line.
- Please turn off the valve of the leaking gas and then open the doors and windows in case of leakage of gas and other flammable gases.
- Do not unplug the refrigerator and other electrical appliances considering that spark may cause a fire.
- Do not use electrical appliances on the top of the appliance, unless they are of the type recommended by the manufacturer.
- The gaps between refrigerator doors and between doors and refrigerator body are small, be noted not to put your hand in these areas to prevent from squeezing the finger. Please be gentle when close the refrigerator door to avoid falling articles.
- Do not pick foods or containers with wet hands in the freezing chamber when the refrigerator is running, especially metal containers in order to avoid frostbite.
- Do not allow any child to get into or climb the refrigerator; otherwise suffocation or falling injury of the child may be caused.
- Do not place heavy objects on the top of the refrigerator considering that objectives may fall when close or open the door, and accidental injuries might be caused.
- Do not put flammable, explosive, volatile and highly corrosive items in the refrigerator to prevent damages to the product or fire accidents.
- Do not place flammable items near the refrigerator to avoid fires.
- The refrigerator is intended for household use, such as storage of foods; it shall not be used for other purposes, such as storage of blood, drugs or biological products, etc.
- Do not store beer, beverage or other fluid contained in bottles or enclosed containers in the freezing chamber of the refrigerator; or otherwise the bottles or enclosed containers may crack due to freezing to cause damages.

## WARNING

- Connect to potable water supply only. (Suitable for ice cube maker) (\*)
- To prevent children from being entrapped, the keys must be keep out of reach of children and not in the vicinity of chest freezer (or refrigerator) (suitable for products with locks) (\*)

**(\*): This feature varies depending on the model purchased.**

## **WARNING**

### **State of California Proposition 65 Warnings:**

This product can expose you to chemicals including lead, which is known to the State of California to cause cancer, and bisphenol A (BPA) and lead which are known to the state of California to cause birth defects or other reproductive harm. For more information go to [www.P65Warnings.ca.gov](http://www.P65Warnings.ca.gov).

## **CAUTION**

### **To avoid contamination of food, please respect the following instructions:**

- Opening the door for long periods can cause a significant increase of the temperature in the compartments of the appliance.
- Clean regularly surfaces that can come in contact with food and accessible drainage systems.
- Clean water tanks if they have not been used for 48h; flush the water system connected to a water supply if water has not been drawn for 5 days. (\*)

## **WARNING**

- **WARNING:** Fill with potable water only. (\*)
- **WARNING:** Connect to potable water supply only. (Suitable for ice making machine) (\*)

**(\*): This feature varies depending on the model purchased.**

## **CAUTION**

**This product is not recommended for use with sockets or main switch with the A/GFCI function, otherwise it may cause false tripping.**

1. It's not supposed to be a safety risk when tripped.
2. If tripping persists, it is recommended to replace the sockets or main switch without A/GFCI function.

## **WARNING**

**Risk of child entrapment. Before you throw away your old refrigerator or freezer:**

- Take off the doors.
- Leave the shelves in place so that children may not easily climb inside.

## | ENVIRONMENTAL PROTECTION

### Disposing of old electrical devices in an environmentally-friendly manner

This product can expose you to chemicals including lead, which is known to the State of California to cause cancer, and bisphenol A (BPA) and lead which are known to the state of California to cause birth defects or other reproductive harm. For more information go to [www.P65Warnings.ca.gov](http://www.P65Warnings.ca.gov).



This crossed-out wheeled bin symbol indicates that waste electrical and electronic products (WEEE) should be disposed of separately from the municipal waste stream.

Old electrical products can contain hazardous substances so correct disposal of your old appliance will help prevent potential negative consequences for the environment and human health. Your old appliance may contain reusable parts that could be used to repair other products, and other valuable materials that can be recycled to conserve limited resources.

### CAUTION

Refrigerant and cyclopentane foaming material used for the refrigerator are flammable. Therefore, when the refrigerator is scrapped, it shall be kept away from any fire source and be recovered by a special recovering company with corresponding qualification other than be disposed by combustion, so as to prevent damage to the environment or any other harm.

### PACKAGE INFORMATION

Packaging materials of the product are manufactured from recyclable materials in accordance with our National Environment Regulations. Do not dispose of the packaging materials together with the domestic or other wastes. Take them to the packaging material collection points designated by the local authorities.

# INSTALL INSTRUCTION

## Before first use

Remove the exterior and interior packing, wipe the outside thoroughly with a soft dry cloth and the inside with a wet, lukewarm cloth.

Avoid placing the cabinet in a narrow recess or near any heat source, direct sunlight, or moisture.

Let air circulate freely around the cabinet. When installing the unit, ensure that 10cm of free space is left at both sides, 10cm at the rear of the unit and 10cm at the top of the unit.

Before connecting your refrigerator to the power supply, check that the voltage stated on the rating label of your appliance corresponds to the voltage in your home.

A different voltage could damage the appliance.

The appliance must be grounded. The manufacturer is not responsible for damages that may occur as a result of usage without grounding.

## Space requirement diagram

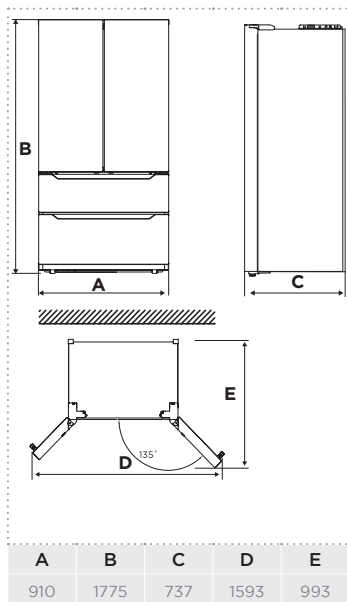

Notice: All dimensions in mm

## Providing a proper power supply

Check your local power source. This refrigerator requires a AC115 V, 60 Hz power supply.

Use a receptacle that accepts the grounding prong. The power cord is equipped with a 3-prong (grounding) plug which mates with a standard 3-prong (grounding) wall outlet to minimize the possibility of electric shock hazard from this refrigerator.

**If you have any doubts regarding installation, please turn to the vendor, to our customer service or to the nearest Authorised Service Centre.**

## CAUTION

The refrigerator should always be plugged into its own individual electrical outlet which has a voltage rating that matches the rating plate. When positioning the appliance, ensure the supply cord is not trapped or damaged.

## CONNECTING THE APPLIANCE

After installing the product, please let it stay for more than 2 hours before turning on the power, otherwise it will lead to a decrease in cooling capacity or a damage to the product.

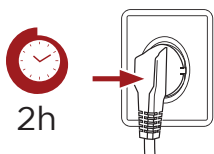

Allow the appliance to run empty for 24 hours so the compartment can cool to the appropriate temperature.

## ATTENTION

The cooling performance and power consumption of the refrigerator may be affected by the ambient temperature, the door-opening frequency, and the location of the refrigerator. We recommend adjusting the temperature settings as appropriate.

## LEVELING FEET

**To avoid vibration, the appliance must be leveled.**

If required, adjust the leveling feet to compensate for the uneven floor.

The front should be slightly higher than the rear to aid in door closing.

Leveling feet can be turned easily by tipping the cabinet slightly.

Turn the leveling feet counter clockwise ↺ to raise the unit, clockwise ↻ to lower it.

## ADJUSTMENT OF CANTILEVER RACK

**Please adjust the cantilever rack by following the arrows as shown in the diagram.**

1. Raise it upward first and then take it out by tilting it upward.
2. During installation, put the upper end of the fixed leg into one of the upper slots on the supporting iron first.
3. And then put the lower end of the fixed leg into the third slot on the lower part of the supporting iron.

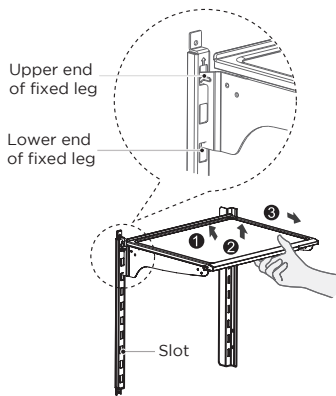

### ATTENTION

The cantilever rack could be adjusted to the proper height as required by food.

## DISASSEMBLY OF FREEZER DRAWER

**The process to remove both the upper and lower freezer drawer on the unit is the same.**

1. First, pull out the freezer drawer you wish to remove and take out the bin.
  2. Push down on one of the lock buttons at the rear of the left or right glide rails and pull the drawer straight out slightly until it unlocks. See the image below for button location.
  3. Do the same with the other side until both sides are unlocked. Then, slowly pull out the entire drawer.
- NOTE:** Both drawers are equipped with plastic retainers to prevent the release buttons from moving during shipping. These need to be removed before you can access the lock buttons.
4. To put the drawers back on, reverse the steps above.

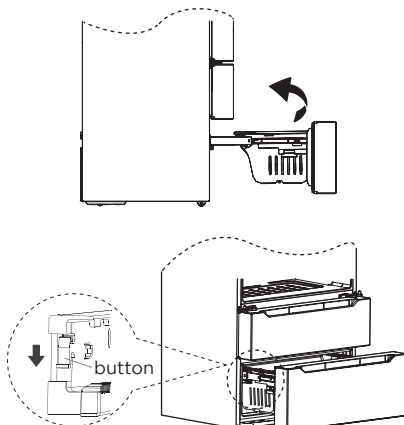

### ATTENTION

Don't remove the lower freezer drawer if not necessary.

## INSTALLING THE WATER LINE

### **WARNING: Connect to potable water supply only.**

Water line installation kits are available as an additional accessory from your dealer or at a local hardware store.

The new hose-sets supplied with the appliance are to be used and that old hose-sets should not be reused.

### **Connecting to the water supply line**

- 1.** First, shut off the main water supply line and turn the ice-maker off.
- 2.** Locate the nearest cold water supply valve.
- 3.** After connecting the water supply to the water valve, turn your main water supply back on and flush several gallons of water to clear the water supply line.

- **The minimum inlet water pressure: 147kPa**
- **The maximum inlet water pressure: 834kPa**

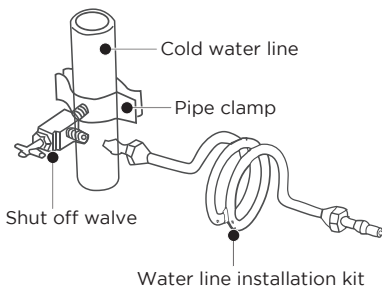

### **Connecting the water line to the refrigerator.**

There are several items that you need to purchase to complete this connection.

You will find these items sold as a kit at your local hardware store.

- 1.** First, water tubes (supplied) insert into corresponding hole of water connector (supplied).
- 2.** Second, water line installation kit (not included) inserts into another hole of water connector (supplied).
- 3.** Turn water valve on and check for any leakage.

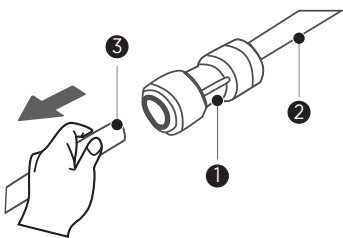

### **Connecting the water line to a drinkable water source**

If your water line is NOT drinkable, please add an external water filter.

If you must repair or disassemble the water line, cut off the plastic tubing to make sure you get a snug, leak-free connection.

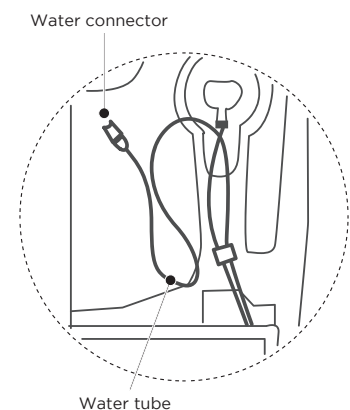

## LEVELLING DOORS

If the doors are not at the same height, the door can be adjusted with a spanner.

1. Raise the lower door up to the level of the higher door.
2. Insert the supplied fastener-ring by using plier in the gap between the hinge-grommet and the lower hinge. The number of fastener-rings you will need to insert depends on the gap.

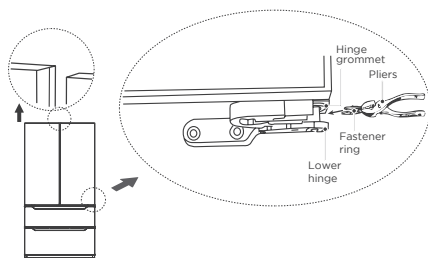

## CHANGING THE LIGHT

Any replacement or maintenance of the LED lamps is intended to be made by the manufacturer, its service agent or similar qualified person.

### ATTENTION

After connecting the power supply cord (or plug) to the outlet, wait 2 or 3 hours before you put food into the appliance. If you add food before the appliance has cooled completely, your food may spoil.

## MOVING THE APPLIANCE

1. Remove all items from the appliance.
2. Pull the power plug out, insert and fix it into the power plug hook at the rear or on top of the appliance.
3. Tape parts such as shelves and the door to prevent from falling off while moving the appliance.
4. Move the appliance with more than two people carefully. When transporting the appliance over a long distance, keep the appliance upright.

## TIPS FOR ENERGY SAVING

- Do not place the appliance near cookers, radiators or other heat sources. If the ambient temperature is high, the compressor will run more frequently and for longer, resulting in increased energy consumption.
- Ensure that there is sufficient ventilation at the base of the appliance, on the sides of the appliance and at the back of the appliance.
- Please also observe the spacing dimensions in the chapter "Installation".
- The arrangement of drawers, shelves and trays as shown in the product overview offers the most efficient use of energy and should be retained as far as possible.
- To obtain a larger storage space (e.g. for large refrigerated/frozen goods), the middle drawers and shelves can be removed. The top and bottom drawers and shelves should be removed last if necessary.
- An evenly filled refrigerator/freezer compartment contributes to optimal energy use.
- Allow warm food to cool before placing it in the refrigerator/freezer compartment. Food that has already cooled down increases energy efficiency.
- Allow frozen food to defrost in the refrigeration compartment. The coldness of the frozen food reduces the energy consumption in the refrigerator compartment and this increases the energy efficiency.

- Open the door only as briefly as necessary to minimise cold loss. Opening the door briefly and closing it properly reduces energy consumption.
- Setting the temperature no colder than necessary contributes to optimal energy use.
- The door gaskets of your appliance must be perfectly intact so that the doors close properly and energy consumption is not increased unnecessarily.

## PRODUCT OVERVIEW

### PARTS AND FUNCTIONS

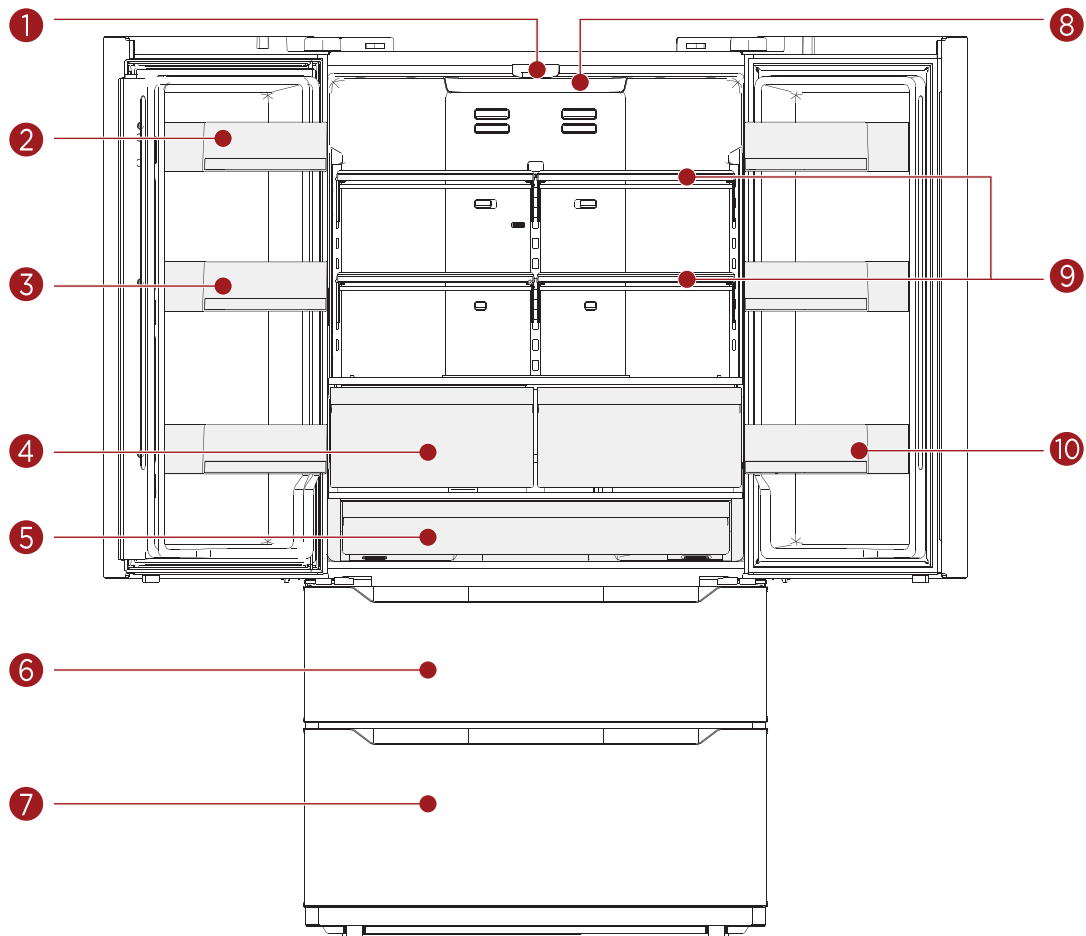

- |                          |                                     |
|--------------------------|-------------------------------------|
| <b>1.</b> Led light      | <b>6.</b> Upper freezer drawer      |
| <b>2.</b> Dairy bin      | <b>7.</b> Lower freezer drawer      |
| <b>3.</b> Door tray      | <b>8.</b> Control and display panel |
| <b>4.</b> Crisper drawer | <b>9.</b> Shelf                     |
| <b>5.</b> Big drawer     | <b>10.</b> Door tray                |

- For the most efficient use of energy, please keep the all internal items such as trays, drawers, shelves and ice cube box on the position supplied by manufacturer.
- This refrigerating appliance needs to be installed independently and cannot be used as a built-in. Otherwise, it will cause problems such the performance and life of the appliance are reduced. And the manufacturer does not provide basic appliance warrant.

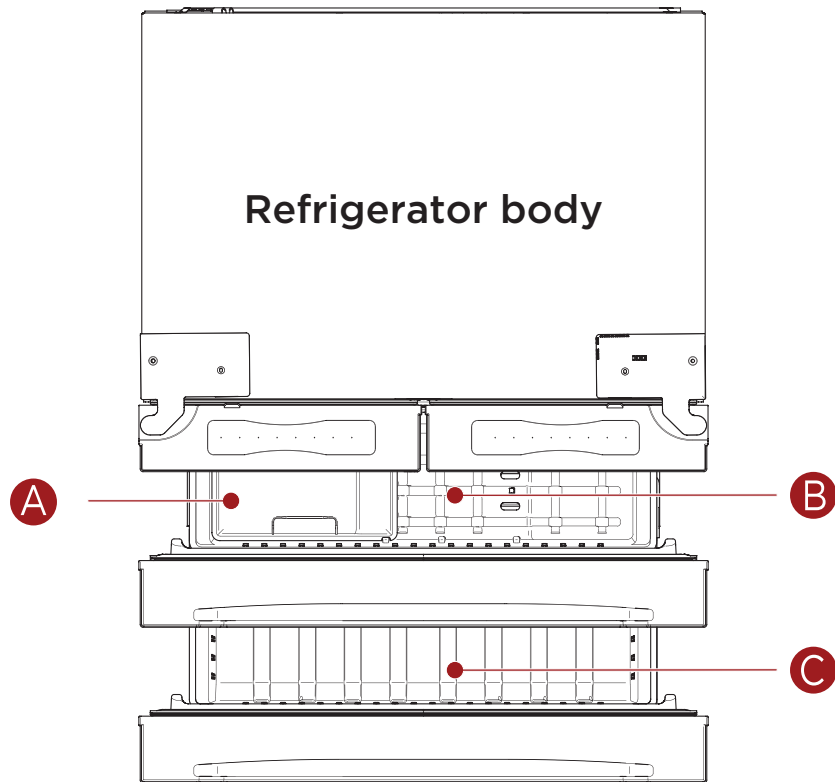

- A.** Ice storage bin
- B.** Upper freezer drawer
- C.** Lower freezer drawer

### Ice maker

Incorporated ice-makers installed only by the manufacturer or its service agent.

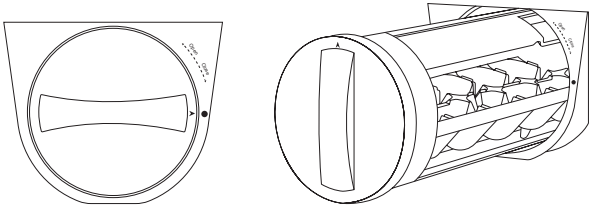

- The ice maker is located in the upper freezer above the ice storage bin. To make ice, ensure the ice maker is in the closed position with the arrow pointed right (see below, left). The ice maker stores up to 1.75 pounds of ice and can make up to 4.85 pounds daily. It takes up to 6 hours to produce ice when the appliance is plugged in for the first time. To remove the ice maker for cleaning, simply twist to the open position and pull out (see below, right).

### **ATTENTION**

**Differences:** Due to technical changes and different models, some of the illustrations in this manual may differ from your model.

# OPERATION INSTRUCTIONS

## USE AND FUNCTIONS

### Feature panel

Incorporated ice-makers installed only by the manufacturer or its service agent.

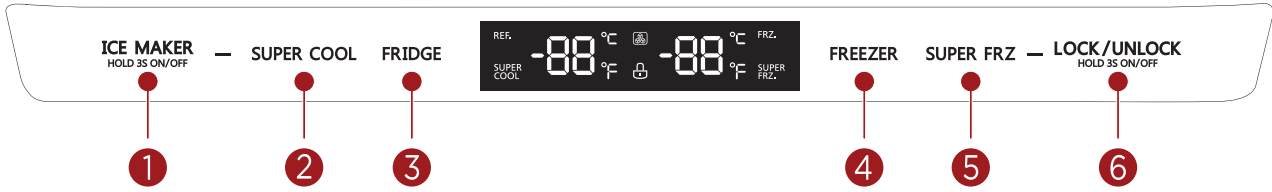

### Display

1. Ice-making button
2. Supper cool button
3. Temperature adjusting button of refrigerator room

### Button

4. Temperature adjusting button of freezer room
5. Super freezer button
6. Lock/unlock button

## ATTENTION

The actual control panel may differ from model to model.

Function	Settings and Status
Display	<ul style="list-style-type: none"> <li>• When electrify the refrigerator, the display screen will totally display for 3 seconds, meanwhile the starting up bell rings, then the display screen enters the normal display of operation. (If power on for first time, the default set temperature of the refrigerator room and the freezer room is 4°C/-1°C).</li> <li>• It will display the set temperature of both refrigerator and freezer rooms when there is no fault.</li> <li>• Under normal circumstances, the display light will go out after 30 seconds in lock state, button operation on display panel would wake up the display screen; if the opening door action wakes up the display screen, the display light would go out immediately when the door is closed; when the "fault code visible" type of fault occurs, the display screen lights up, and will go out after 30 seconds.</li> </ul>
Lock/Unlock	<ul style="list-style-type: none"> <li>• In the unlock state, press and hold the lock/unlock button for 3 seconds to enter the lock state, and the buzzer sound rings.</li> <li>• In the lock state, press and hold the lock button for 3 seconds to enter the unlock state and the buzzer sound rings.</li> <li>• It will enter the lock state if there is no opening door action or any buttons operation within 30 seconds.</li> <li>• The alarm sound can be stopped by pressing any one button in lock state, but all other button operations need to be performed in unlock state. If you operate in the lock state, an error beep will be given.</li> </ul>
Refrigerate compartment temperature adjustment	<ul style="list-style-type: none"> <li>• Click the temperature adjusting button of refrigerator room to change the set temperature of refrigerator room. Each time click the button, the set temperature will drop 1°C. When the set temperature reaches the 2°C, click the button again, the set temperature will switch to 8°C.</li> <li>• The temperature setting will take effect after the display panel is locked.</li> </ul>

Function	Settings and Status
<b>Freezer compartment temperature adjustment</b>	<ul style="list-style-type: none"> <li>Click the temperature adjusting button of freezer room to change the set temperature of freezer room. Each time click the button, the set temperature will drop 1°C. When the set temperature reaches the -24°C, click the button again, the set temperature will switch to -16°C. The temperature setting will take effect after the display panel is locked.</li> </ul>
<b>Mode setting</b>	<ul style="list-style-type: none"> <li>Press the <b>SUPER COOL</b> button to start the super-cooling function, the refrigeration will be automatically set to 2°C, and the <b>SUPER COOL</b> icon will light up, and it will take effect after locking, the maximum duration is 6h. When exiting the super-cooling mode, the set temperature of the refrigerator will automatically return to the temperature before the super cooling mode.</li> <li>Press the <b>SUPER FRZ</b> button to start the super-freezing function, the freezing is automatically set to -24°C, and the <b>SUPER FRZ</b> icon is on, and it will take effect after locking, and the maximum duration is 24h. When exiting the super-freezing mode, the set temperature of the freezer will automatically return to the previous setting of the super-freezing mode temperature.</li> <li>Press the <b>ICE MAKER</b> <small>HOLD 3S ON/OFF</small> button, the ice making function will switch between on/off. When the ice making  icon is on, it means the ice making function is activated, and it will take effect after being locked.</li> <li><b>Note:</b> When conducting a power consumption test, tie the ice probe to make it full of ice by default.</li> </ul>

## ATTENTION

**Recommended setting:** Refrigerated chamber 4°C, freezing chamber -18°C. The quick-freezing function is designed to maintain the nutritional value of the food in the freezer. It can freeze the food in the shortest time. If a large amount of food is frozen at one time, it is recommended that the user turn on the quick-freezing function and put the food in. At this time, the freezing speed of the freezer compartment is increased, which can quickly freeze the food, effectively lock the nutrition of the food, and facilitate storage.

### Fault code

When the following tips to appear on the display screen, it indicates a problem with the refrigerator. Although the refrigerator in the following fault case can still provide cool/freeze functions, but the user should contact maintenance personnel, ensure the normal use of refrigerator.

Fault code	Fault Description
<b>E0</b>	Ice maker error
<b>E1</b>	Refrigeration temperature sensor fault
<b>E2</b>	Freezer temperature sensor fault
<b>E5</b>	Freezer defrost sensor fault
<b>E6</b>	Communication fails
<b>E7</b>	Ambient temperature sensor fault
<b>EH</b>	Humidity sensor fault

## | **STORING FOOD**

### **Freezer compartment**

The freezer compartment is designated for the low-temperature freezing of food, long-term storage of frozen food, and for the production of ice cubes.

Pay attention to the star classifications (4 star, 2 star and 1 star) in the freezer compartment and the resulting storage periods for frozen food.

Do not put fresh and frozen food next to each other. The frozen food may thaw.

When freezing large amounts of fresh food (such as meat, fish or chopped meat), please divide them into several small pieces before putting in, so that they can be quickly frozen and pick up easily.

Abide by the storage times recommended by food manufacturers on the packages, there is no information on the packaging, food should not be stored frozen for longer than three months from the date of purchase.

When purchasing frozen food, make sure that it was frozen at a suitable temperature and that the packaging is not damaged.

Frozen food should be kept in suitable individual packages to ensure that adjacent food cannot be contaminated. Consume thawed and defrosted foods immediately, do not refreeze them.

In case of prolonged power failure or malfunction of the appliance, remove the stored frozen food and check whether they are still edible, then store them in a sufficiently cool place or in another appliance.

To defrost food, remove it from the freezer and let it defrost at room temperature or in the refrigerator.

To defrost food quickly, you can use the defrost function on your microwave, for example.

If you only want to defrost part of a pack, remove the portion you need and immediately close the rest of the pack. In this way, you will avoid “freezer burn” and will reduce ice formation on the remaining foods.

### **Cooling compartment**

To reduce moisture and subsequent ice build-up, never put liquid into the fridge compartment in unsealed containers. Frost tends to concentrate in the coolest parts of the evaporator.

Storing uncovered liquids results in a more frequent need for defrosting.

Never put warm foods in the fridge compartment. These should first cool down at room temperature and then be placed so as to ensure adequate air circulation in the fridge compartment.

Foods or food containers should not touch the back wall of the fridge because they could freeze to the wall. Do not keep regularly opening the door of the refrigerator.

Meat and clean fish (packed in a package or plastic foil) can be placed in the fridge compartment, which can be used in 1-2 days.

Fruit and vegetables without packaging can be placed in the part designated for fresh fruit and vegetables.

### **ATTENTION**

Storage of too much food during operation after the initial connection to power may adversely affect the freezing effect of the refrigerator.

## Storage times and temperature

**NOTE:** Overlong storage or storage at inappropriate freezing temperature may cause a quality loss or spoiled foods, which causes food waste, is inedible and may cause food poisoning.

The minimum temperature in most cases should be -18°C or colder.

Follow the maximum recommended storage times below:

- Stew, ice cream, sausages, bread: 2-6 months.
- Fish, shrimp, lamb, meat: 4-8 months.
- Vegetables, fruits, poultry, beef: 6-12 months.

## | MAINTENANCE AND CLEANING

### CAUTION

Disconnect the appliance from the electrical supply before undertaking any routine maintenance.

Allow at least 5 minutes before restarting the appliance, as frequent starting may damage the compressor.

Do not use mechanical devices or other means to accelerate the defrosting process, other than those recommended by the manufacturer.

Do not try to repair, disassemble or modify the appliance by yourself. In case of repair please contact our customer service.

Eliminate the dust on the back of the unit at least once in the year to avoid hazard by fire, as well as increased energy consumption.

Check the door gasket regularly to make sure there are no debris. Clean the door gasket with a soft cloth dampened with soapy water or diluted detergent.

The interior of the product should be cleaned regularly to avoid odor.

Use a soft cloth or sponge to clean the inside of the product, with two tablespoons of baking soda and a quart of warm water. Then rinse with water and wipe clean. After cleaning, open the door and let it dry naturally before turning on the power.

For areas that are difficult to clean in the product (such as narrow sandwiches, gaps or corners), it is recommended to wipe them regularly with a soft rag, soft brush, etc. and when necessary, combined with some auxiliary tools (such as thin sticks) to ensure no contaminants or bacteria accumulation in these areas.

Wipe the outer surface of the product with a soft cloth dampened with soapy water, detergent, etc. and then wipe dry.

Do not use hard brushes, clean steel balls, wire brushes, abrasives (such as toothpastes), organic solvents (such as alcohol, acetone, banana oil, etc.) boiling water, acid or alkaline items, which may damage the fridge surface and interior. Boiling water and organic solvents such as benzene may deform or damage plastic parts.

Do not rinse directly with water or other liquids during cleaning to avoid short circuits or affect electrical insulation after immersion.



## Defrosting

Although this appliance automatically defrosts, a layer of frost may occur on the freezer compartment's interior walls if the freezer door is opened frequently or kept open too long. If the frost is too thick, choose a time when the supply of food stocks are low and proceed as follows:

1. Remove existing food and accessories baskets, unplug the appliance from the mains power and leave the doors open. Ventilate the room thoroughly to accelerate the thawing process.
2. When defrosting is completed, clean your freezer as described above.

**CAUTION!** Don't use sharp objects to remove frost from the freezer. Only after the interior completely dry should the appliance be switched back on and plugged back into the mains socket.

## ATTENTION

The appliance shall run continuously once it is started. Generally, the operation of the appliance shall not be interrupted; otherwise the service life may be impaired.

## Cleaning of door tray

According to the direction arrow in the figure below, use both hands to squeeze the tray, and push it upward, then you can take it out.

After washing the tray having been taken out, you can adjust its installing height in accordance with your requirement.

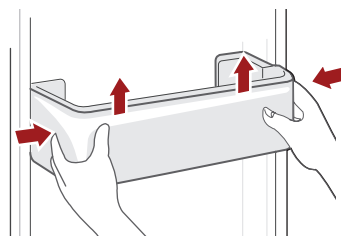

## Cleaning the drawer

1. Remove the contents of the drawer. Hold the handle of the drawer and pull it out completely until it stops.
2. Lift the drawer up and remove it by pulling it out.

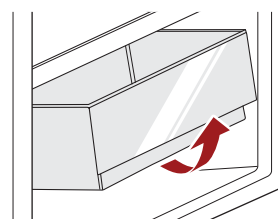

## Cleaning the freezer drawer and glass shelf

Regarding the information pertaining to cleaning the drawer and glass shelf. Thanks to refer to the paragraph “Disassembly of freezer drawer” “Adjustment of cantilever rack” of the manual.

## Water line cleaning function of ice maker

1. Open the upper freezer drawer, follow the instructions on the Ice maker, and take out the ice tray by turning the knob of the Ice maker to clean it.
2. Close the upper and lower freezer drawers.
3. Press the ICE MAKER and FRIDGE buttons simultaneously for 3 seconds to enter the Water Line Cleaning Function, the buzzer will sound 3 times, press the LOCK button to lock the screen, the mode will take effect.
4. During the process, the FRIDGE zone displays “CL” and keeps flashing. After the cleaning is completed, the FRIDGE zone “CL” stops flashing and returns to the normal display, and the buzzer sounds 3 times at the same time.
5. Follow the instructions on the Ice maker to install the Ice maker back.

## ATTENTION

1. After cleaning the water line, the water in the ice storage box needs to be drained and cleaned.
2. During the water line cleaning process, the water may splash out of the ice storage box and flow into the freezer drawer, and the splashed water needs to be cleaned up.

## CAUTION

- It is forbidden to open the upper or lower freezer drawer of the refrigerator in the Water Linea Cleaning Function, otherwise the mode will be suspended, and some residual water may flow to the lower freezer drawer. After the refrigerator upper and lower freezer drawers are closed, this function will be resumed.
- It is forbidden to continuously turn on the Water Line Cleaning Function of the Ice maker. The interval between two water line cleanings of the Ice maker is at least 10 minutes, and the Water Line Cleaning Function of the Ice maker can only be performed at most 2 times within one hour.

## | TROUBLESHOOTING

The following simple issues can be handled by the user.

Please call the after-sale service department if the issues are not solved.

Problem	Possible Causes	Solution
Not operate	<ul style="list-style-type: none"><li>• The power supply is not turned on and the plug is not firmly inserted.</li><li>• Low voltage, power failure or part of the circuit tripped.</li></ul>	<ul style="list-style-type: none"><li>• Insert the power cord plug firmly.</li><li>• Check the power supply at home.</li></ul>
Light not on	<ul style="list-style-type: none"><li>• The appliance is not powered on.</li><li>• The light is broken.</li></ul>	<ul style="list-style-type: none"><li>• Unplug and re-plug the power cord.</li><li>• Replace the light with a new one.</li></ul>
Fruits or vegetables are frozen	<ul style="list-style-type: none"><li>• Has the food been placed at the back of the fridge? The area near the back wall is where the temperatures are coldest.</li><li>• Fruits or vegetables are stored in the Fresh/Chill zone.</li></ul>	<ul style="list-style-type: none"><li>• Not placing food which may freeze easily at the back of the fridge compartment.</li><li>• The Fresh/Chill zone is only for meat/fish.</li></ul>
Fridge/freezer is over-cooling	<ul style="list-style-type: none"><li>• Temperature control is not set correctly.</li></ul>	<ul style="list-style-type: none"><li>• Set the temperature higher.</li></ul>
Compressor working for a long time	<ul style="list-style-type: none"><li>• High ambient temperature causing long working time.</li><li>• Putting too much food in at one time.</li><li>• Food is put in before it has cooled down.</li><li>• Opening the door too often.</li><li>• The frost layer inside is too thick.</li></ul>	<ul style="list-style-type: none"><li>• This is normal.</li><li>• Do not put too much food in at one time.</li><li>• Wait until the food has cooled down before putting it in.</li><li>• Do not open the door too often.</li><li>• Need to defrost.</li></ul>
Door does not close properly	<ul style="list-style-type: none"><li>• Door is stuck with objects.</li><li>• Too much food in.</li><li>• Door gasket deformed.</li></ul>	<ul style="list-style-type: none"><li>• Do not put in too much food.</li><li>• Place the appliance stably.</li><li>• Heat the door gasket, then cool it for restoration (with an electrical drier or hot water for heating).</li></ul>
Outer wall is hot	<ul style="list-style-type: none"><li>• When the appliance is operating, heat is dissipated to the outside through the metal tubes inside the cabinet.</li><li>• Higher ambient temperatures in the summer cause the temperature of the outer wall to rise.</li></ul>	<ul style="list-style-type: none"><li>• Higher temperature on the outer wall is normal.</li><li>• Increase the heat dissipation space, or put the appliance in a ventilated and cool place.</li></ul>
Cross or vertical beams are hot	<ul style="list-style-type: none"><li>• There are metal tubes inside the beams, and the heat released from the tubes prevents condensation.</li></ul>	<ul style="list-style-type: none"><li>• This is normal.</li></ul>

Problem	Possible Causes	Solution
Odors	<ul style="list-style-type: none"> <li>• Spoiled food.</li> <li>• Food with strong odors.</li> <li>• The interior compartment is dirty.</li> </ul>	<ul style="list-style-type: none"> <li>• Clean and remove any spoiled food.</li> <li>• Make sure strong smelling food is wrapped airtight.</li> <li>• Clean the interior compartment.</li> </ul>
The actual temperature differs from the set temperature	<ul style="list-style-type: none"> <li>• When warm food is put in, the temperature will rise temporarily.</li> <li>• After setting a new temperature, it will take some time for the temperature in the compartment to reach the set temperature when the door is not opened.</li> <li>• After the temperature stability, the actual temperatures at different locations within the compartment are different, with a deviation of about 33°C.</li> </ul>	<ul style="list-style-type: none"> <li>• This is normal.</li> <li>• Wait for some time before testing the actual temperature.</li> </ul>
Condensation forms on the outside	<ul style="list-style-type: none"> <li>• Condensation may form when the humidity in the room is high.</li> </ul>	<ul style="list-style-type: none"> <li>• This is normal. Wipe off the condensation using a dry cloth.</li> </ul>
Condensation forms inside the fridge and drawers	<ul style="list-style-type: none"> <li>• The fridge maintains a high humidity to keep vegetables and other food items fresh.</li> <li>• Humidity is too high in the room and doors have been opened frequently.</li> <li>• The door gasket are not tight.</li> </ul>	<ul style="list-style-type: none"> <li>• Wipe off the condensation using a dry cloth.</li> <li>• Do not open the doors as frequently or do not keep them open too long.</li> <li>• Check the door gasket, clean or correct position.</li> </ul>
Frost around the vents	<ul style="list-style-type: none"> <li>• Door is not closed properly.</li> <li>• The door gasket are not tight.</li> </ul>	<ul style="list-style-type: none"> <li>• Make sure food does not block the door.</li> <li>• Check the door gasket, clean or correct position.</li> </ul>
Hard to open the door	<ul style="list-style-type: none"> <li>• The difference in air pressure between the inside and outside of the compartment may sometimes make it hard to open the freezer door.</li> </ul>	<ul style="list-style-type: none"> <li>• Wait a few moments, and then try to open the door slowly.</li> </ul>
Not making ice cubes (Only models with ice maker)	<ul style="list-style-type: none"> <li>• The ice making function not turned on.</li> <li>• The appliance is not being supplied with water.</li> <li>• The water pipe has kinks in it.</li> <li>• The water pipe connection is installed incorrectly.</li> <li>• Water pressure is too low.</li> </ul>	<ul style="list-style-type: none"> <li>• Switch on the ice maker.</li> <li>• Check whether the water supply is on.</li> <li>• Straighten out the kinks.</li> <li>• Check the water connection.</li> <li>• Check the pressure of the water supply, or whether the filter is clogged.</li> </ul>

**Certain sounds can be heard during normal use of the refrigerator, which do not affect its correct operation.**

**Sounds, which can be easily prevented:**

- Noise caused by the appliance which is not level - adjust the position with the adjustable turn-in front feet. Alternatively, place pads made of soft material under the rear rollers, especially when the appliance is placed on tiles.
- Touching the adjacent piece of furniture - move the refrigerator away.
- Creaking of the drawers or shelves - take out and put back the drawer or shelf.
- Sounds of clinking bottles - move bottles apart.

Sounds heard during normal use are mainly due to operation of the compressor (switching on) and cooling system (thermal expansion and contraction of the radiator caused by flow of the cooling agent).



WE TRANSFORM A SIMPLE KITCHEN INTO A PRO ONE.  
THIS IS WHY WE CARE ABOUT MAKING VERY HIGH PERFORMANCE  
RANGES AND HOODS, TO MAKE YOU FEEL LIKE A PRO AND STYLISH COOKER.

DESIGN: LONDON DC - [WWW.LONDON-DC.COM](http://WWW.LONDON-DC.COM)

FOR MORE DETAILS AND INFORMATION, PLEASE VISIT OUR WEBSITE [WWW.KUCHT.COM](http://WWW.KUCHT.COM)