

48" DUAL FUEL RANGE



A synthesis of beauty and functionality, the Majestic II series provides a premier cooking experience. As the centerpiece of your kitchen, it boasts handcrafted details such as rounded lines, custom finishes, ergonomic design, and innovative technology, inspired by the professional cooking world.

Fuel Type..... **Dual Fuel**
 Gas Type..... **Liquid Propane or Natural Gas**

OVEN COLORS



TRIM*



*Trim colors are available for every range color.

FEATURES

Cooktop

Cooktop surface.....	Deep Recessed
Number of Burners/Elements.....	8
Gas Heat Configuration.....	Sealed Burners
Burner/ Element Fuel.....	Gas
Grate Type.....	Cast Iron
Cooktop Control Type.....	Knobs
Cooktop Control Location.....	Front
Burner Output No. 1.....	20,000 BTU/ Dual Burner
Burner Output No. 2.....	6,100 BTU/ Small Burner
Burner Output No. 3.....	6,100 BTU/ Small Burner
Burner Output No. 4.....	15,500 BTU/ Dual Burner
Burner Output No. 5.....	15,500 BTU/ Large Burner
Burner Output No. 6.....	10,500 BTU/ Large Burner
Burner Output No. 7.....	10,500 BTU/ Large Burner
Burner Output No. 8.....	10,500 BTU/ Large Burner

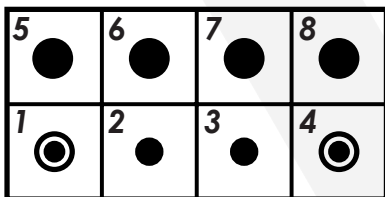

Oven

Oven Fuel.....	Electric
Oven Door Type.....	Solid Door
Oven Type.....	Convection
Oven Cleaning Type.....	Self-Clean Mode
Oven Control Type.....	Display
Oven Control Place.....	Front
Oven Light(s) in Main Oven.....	2
Oven Light(s) in Second Oven.....	1
Oven Light Type.....	LED
No. of Rack Holders (Main Oven).....	5
No. of Rack Holders (Second Oven).....	5
Rack Placement Type.....	Plain
Soft Close Door.....	Yes
Display.....	TFT Touchscreen
Broiler.....	Electric
Child Safety Lock.....	Yes
Timer.....	Yes
Built-in Thermostat.....	Yes
Internal Thermometer.....	Yes

INCLUDED

Range Hood.....	No	Oven Racks (Main Oven).....	2
Power Cord.....	Yes	Oven Racks (Second Oven).....	1
Grate.....	Yes	Oven Trays (Main Oven).....	1
Griddle.....	Yes	Oven Trays (Second Oven).....	1
Legs.....	4	Rotisserie (Main Oven).....	1
Backsplash.....	1	Rotisserie (Second Oven).....	1
Conversion Kit.....	Yes	Gas Regulator.....	1
		Manual.....	Yes

POWER

Voltage.....	220 v
Amperage.....	40 amps
Hertz.....	60 (Hz)
Power Cord Length.....	45 11/16" / 116 cm
Power Cord Type.....	Hard wire

RECOMMENDED ACCESSORIES

Toe Kick.....	APZ120140*	BBQ Grill.....	G41903
Wok Ring.....	A09234	Bain-Marie.....	G00201
Chopping Board.....	A48401	Pizza Plate (2nd Oven).....	A41800
Steam Cooker Basins.....	G00202		

MISCELLANEOUS

Warranty Length.....	2 years
Warranty Type.....	Limited
Actual Weight.....	548 lbs / 249 kg
Product Material.....	Stainless Steel

Available in all colors.

DIMENSIONS

RANGE

Range Width.....	47^{13/16"} / 121.5 cm
Range Height without legs.....	29^{2/16"} / 74 cm
Range Min. Height with legs.....	34^{4/16"} / 87 cm
Range Max Height with legs.....	34^{4/16"} / 87 cm
Range Depth.....	26^{6/16"} / 67 cm
Backsplash Width.....	47^{13/16"} / 121.5 cm
Backsplash Height.....	2^{6/16"} / 6 cm
Backsplash Depth.....	9^{9/16"} / 1.5 cm
Main Oven Handle Length.....	29^{2/16"} / 74 cm
Second Oven Handle Length.....	12^{3/16"} / 31 cm
Main Oven Handle Depth over Range.....	2^{3/16"} / 5.5 cm
Second Oven Handle Depth over Range.....	2^{3/16"} / 5.5 cm
Power from bottom.....	9^{7/16"} / 24 cm
Power from right side.....	9^{1/16"} / 23 cm
Gas connector from bottom.....	5^{2/16"} / 13 cm
Gas connector from right side.....	5^{2/16"} / 13 cm

COOKTOP

Cooktop Width.....	47^{13/16"} / 121.5 cm
Cooktop Depth.....	27^{9/16"} / 70 cm
Cooktop Height.....	1^{9/16"} / 4 cm
Cooktop Front Lip Depth over Range.....	2^{1/16"} / 0.3 cm
Cooktop Back Lip Depth over Range.....	1" / 2.5 cm

OVEN

Main Oven Capacity.....	3.5 cu. ft.
Second Oven Capacity.....	1.52 cu. ft.
Main Oven Depth with Door Open 90°.....	15^{6/16"} / 39 cm
Second Oven Depth with Door Open 90°.....	15^{6/16"} / 39 cm
Main Oven Interior Width (Actual).....	25" / 63.5 cm
Main Oven Interior Height (Actual).....	14^{3/16"} / 36 cm
Main Oven Interior Depth (Actual).....	16^{2/16"} / 41 cm
Main Oven Interior Width (Usable).....	23^{4/16"} / 59 cm
Main Oven Interior Height (Usable).....	14^{3/16"} / 36 cm
Main Oven Interior Depth (Usable).....	16^{2/16"} / 41 cm
Second Oven Interior Width (Actual).....	10^{4/16"} / 26 cm
Second Oven Interior Height (Actual).....	13^{3/16"} / 36 cm
Second Oven Interior Depth (Actual).....	17^{8/16"} / 44.5 cm
Second Oven Interior Width (Usable).....	8^{7/16"} / 22.5 cm
Second Oven Interior Height (Usable).....	13^{3/16"} / 36 cm
Second Oven Interior Depth (Usable).....	17^{8/16"} / 44.5 cm
Height between Rack Plates.....	1^{9/16"} / 4 cm
Height between lowest and highest rack.....	7^{14/16"} / 20 cm

STORAGE

Type.....	Warming
Width.....	41^{15/16"} / 106.5 cm
Height.....	2^{12/16"} / 7 cm
Depth.....	16^{15/16"} / 43 cm

LEGS

Range Leg Type.....	Plinth
Range Leg Number.....	4
Adjustable Range Legs.....	No
Levelable Range Legs.....	Yes
Range Leg Min. Height.....	5^{2/16"} / 13 cm
Range Leg Max. Height.....	5^{2/16"} / 13 cm
Space Between Leg and Range (Side).....	0" / 0 cm
Space Between Leg and Range (Front).....	1^{15/16"} / 5 cm
Space Between Leg and Range (Back).....	0" / 0 cm

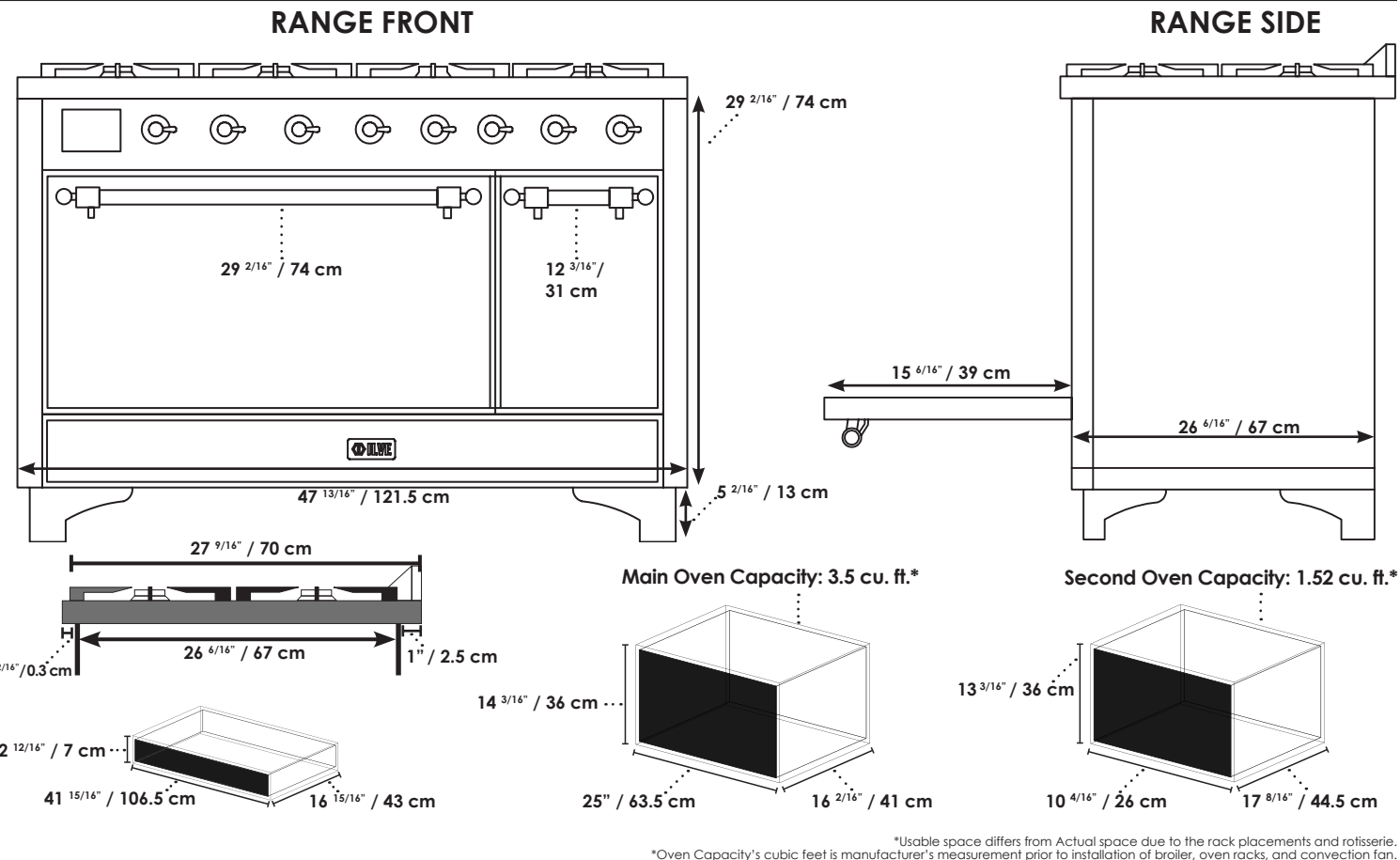

*Usable space differs from Actual space due to the rack placements and rotisserie.
*Oven Capacity's cubic feet is manufacturer's measurement prior to installation of broiler, oven racks, and convection fan.

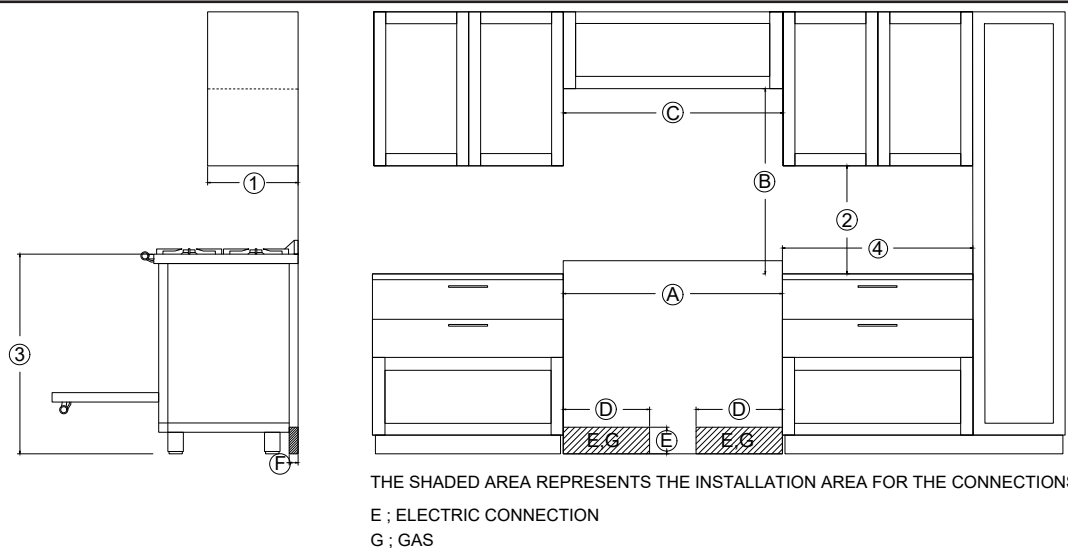

DIMENSIONS	DESCRIPTION
1	13" (330 mm) Maximum depth of top cabinet
2	18" (547 mm) Minimum distance to bottom edge of top cabinet
3	35 1/2"-37" (901-940 mm) Distance from the floor to cooktop surface
4	12" Minimum distance from cooktop surface
A	47 ^{13/16"} (121.5 cm) Width of cabinet opening
B	30" (762mm) Minimum distance between the top of the cooking area and bottom of an unprotected combustible surface
C	47 ^{13/16"} (121.5 cm) Width of the hood area
D	Approx. 10 ^{13/16"} (274mm) Maximum connection with right and left
E	Approx. 4 ^{1/2"} (115mm) Maximum connection height
F	Approx. 2 ^{13/16"} (72mm) Maximum connection depth