

Submittal Data: MULTI30HP230V1AO 30,000 BTU/H Wall Mounted Heat- Pump System

Job Name _____ **Location** _____ **Date** _____

Purchaser _____ **Engineer** _____

Submitted To _____ **For** Reference Approval Construction

Unit Designation _____ **Schedule No.** _____

- GENERAL FEATURES**
- Up to 4 Indoor Units Comfort (4-Port)
 - G10 DC Inverter Technology
 - Quiet Operation - Both Indoor & Outdoor
 - Wireless Remote Controller
 - Optional Wired Remote Controller
 - Gold Fin Coil Coating
 - Intelligent Defrost
 - Auto Restart on Power Outages
 - Limited 7 yr Compressor & 5 yr Parts Warranty



System Ratings

Cooling	
Rated Capacity	29,000 BTU/H
Capacity Range	7,500-34,000 BTU/H
Power Input (Max)	3,450 W
SEER	16
EER	8.2

Outdoor Unit Data

Compressor	Type	DC Inverter Driven Rotary
	RLA	10.0 A
Fan Motor	Output Power	60 W
	FLA	0.6 A
	Air Flow (Max)	1,530 CFM

Heating at 47° F	
Rated Capacity	30,400 BTU/H
Capacity Range	7,500-36,000 BTU/H
Input Power (Max)	2,850 W
HSPF	8.2
COP	3.1

Sound Pressure	
Cooling	56 db(A)
Heating	56 db(A)

Heating at 17° F	
Rated Capacity	17,000 BTU/H
Capacity (Max)	24,860 BTU/H

Dimensions & Weights	
Unit Dimensions (LxHxD)	37.2 x 27.6 x 15.6 -in
Weight (Net/Shipping)	137/148 LBS
Min. Number of Indoor Units	2
Max. Number of Indoor Units	4

Operating Range		
Cooling	(Max)	118°F (48 C)
	(Min)	23°F (-5 C)
Heating	(Max)	80°F (27 C)
	(Min)	5°F (-15 C)

Refrigerant Piping Data

Connection Method	Flared
Refrigerant Type	R410A
Factory Charge for Total Line Length	131-ft
Additional Charge Per Line Length	0.2-oz/ft
Total Refrigerant Pipe Length	230-ft
Max Refrigerant Piping Length to any Indoor Unit	66-ft
Min Refrigerant Piping Length to any Indoor Unit	10-ft
Max Elevation between Indoor Units	33-ft
Max Lift from Outdoor to Indoor Unit	66-ft
Max Drop from Outdoor to Indoor Unit	66-ft

Power Supply	
Normal Operational Voltage	208/230 V, 1 Phase, 60 Hz
Voltage Range	187 - 253 V
Main Power Wire Size	8-2 AWG
Interconnecting Cable Wire Size	14-4 AWG
MCA	26.0 A
MOCP/Breaker Size	45 A

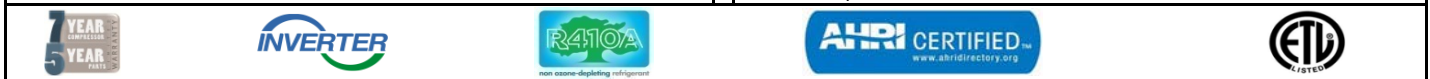

30,000 BTUH MODEL

Model # MULTI30HP230V1AO 30,000 BTUH 230V

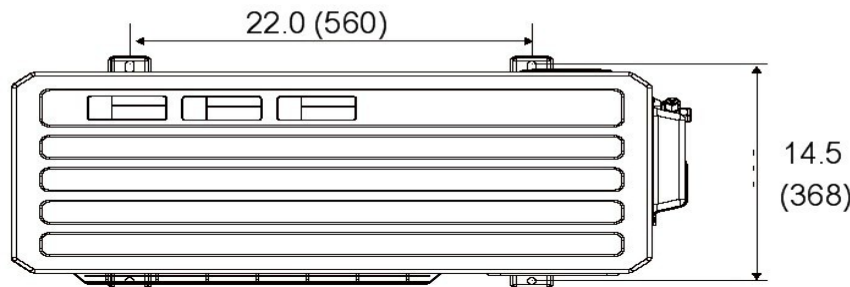
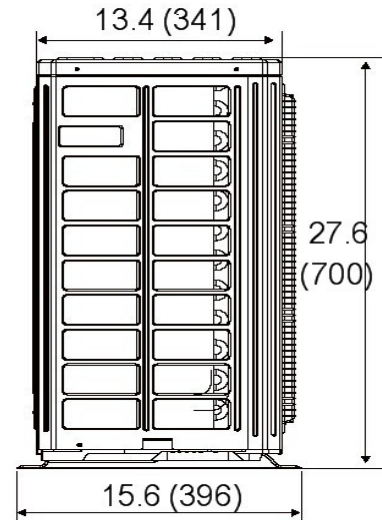
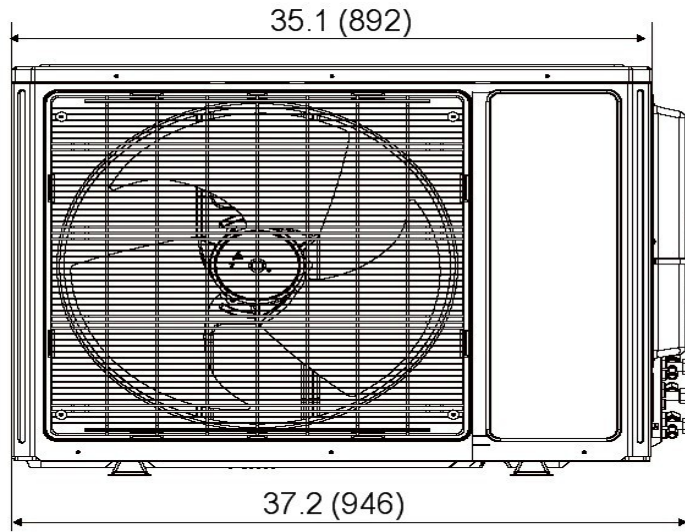

Suction/Gas Line Port Size

Port #1	3/8-in OD Flared
Port #2	3/8-in OD Flared
Port #3	3/8-in OD Flared
Port #4	3/8-in OD Flared

Liquid Line Port Size

Port #1	1/4-in OD Flared
Port #2	1/4-in OD Flared
Port #3	1/4-in OD Flared
Port #4	1/4-in OD Flared

MINIMUM SPACING REQUIREMENTS

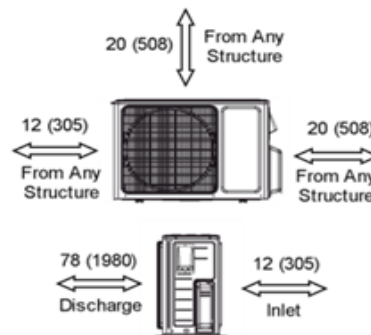
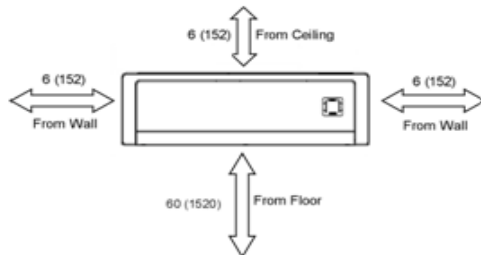

Notes:

1. Recommended Interconnecting Cable Type Stranded Bare Copper Conductors THHN 600V Unshielded Wire
2. Power wiring cable size must comply with applicable national and local codes.
3. Test conditions are based on AHRI 210/240.



www.greecomfort.com

Specifications are subject to change without notice. Manufacturer reserves the right to discontinue or modify specifications or designs without notice or without incurring obligations. All rights reserved.

Units: inch (mm)

9,000 AND 12,000 BTUH MODELS

Model # NEO09HP230VAA-H or GWH09MB-D3DNA3D/I 9,000 BTUH 230V

Model # NEO12HP230VAA-H or GWH12MB-D3DNA3D/I 12,000 BTUH 230V

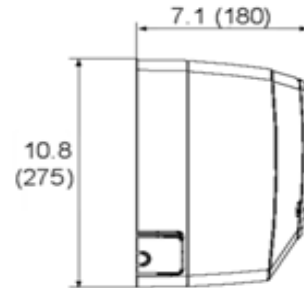
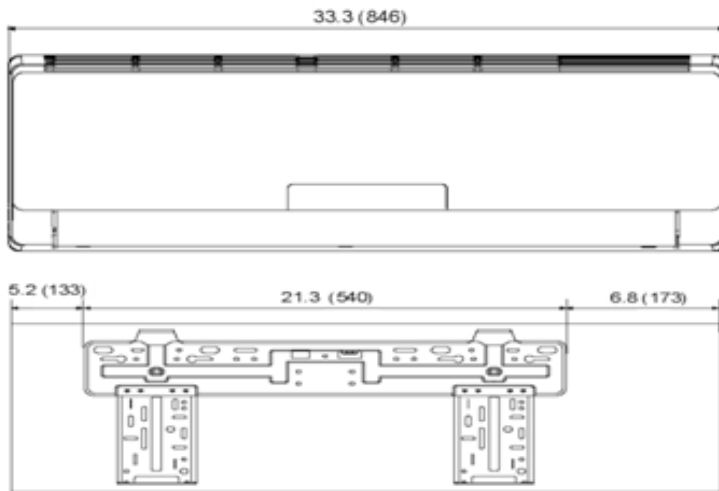

Liquid Line Valve	1/4-in OD Flared
Suction/Gas Line Valve	3/8-in OD Flared
Drain Connector	5/8-in OD

Note: Size Refrigerant lines based on evaporator port sizes.

Indoor Capacity Size	Fan (watts)	CFM (High)	Sound Power (Low/High)**
9,000 BTUH	20	330	26/41
12,000 BTUH	20	341	28/42

Units: inch (mm)

18,000 BTUH MODEL

Model # NEO18HP230VAA-H or GWH18MC-D3DNA3D/I 18,000 BTUH 230V

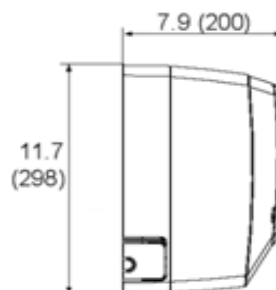
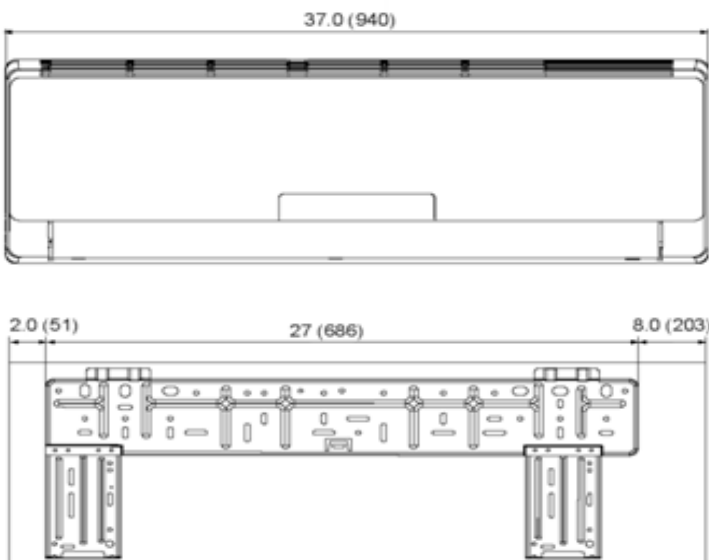

Liquid Line Valve	1/4-in OD Flared
Suction/Gas Line Valve	1/2-in OD Flared
Drain Connector	5/8-in OD

Note: Size Refrigerant lines based on evaporator port sizes.

Indoor Capacity Size	Fan (watts)	CFM (High)	Sound Power (Low/High)**
18,000 BTUH	20	500	35/46



www.greecomfort.com

**Sound Power ratings are per AHRI 270 and AHRI 350

Specifications are subject to change without notice. Manufacturer reserves the right to discontinue or modify specifications or designs without notice or without incurring obligations. All rights reserved.

Units: inch (mm)

9,000 AND 12,000 BTUH MODELS

Model # GWH09AB-D3DNA2D/I 9,000 BTUH 230V

Model # GWH12AB-D3DNA2D/I 12,000 BTUH 230V

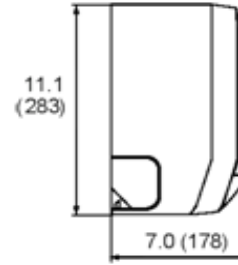
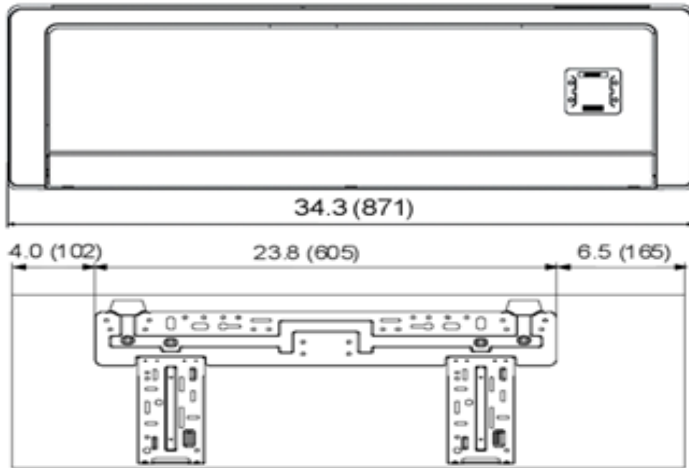

Liquid Line Valve	1/4-in OD Flared
Suction/Gas Line Valve	1/2-in OD Flared
Drain Connector	5/8-in OD

Note: Size Refrigerant lines based on evaporator port sizes.

Indoor Capacity Size	Fan (watts)	CFM (High)	Sound Power (Low/High)**
9,000 BTUH	10	341	28/46
12,000 BTUH	10	353	28/46

Units: inch (mm)

18,000 BTUH MODEL

Model # GWH18AC-D3DNA2D/I 18,000 BTUH 230V

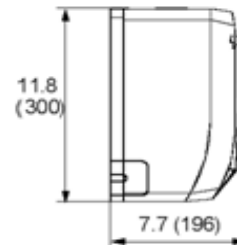
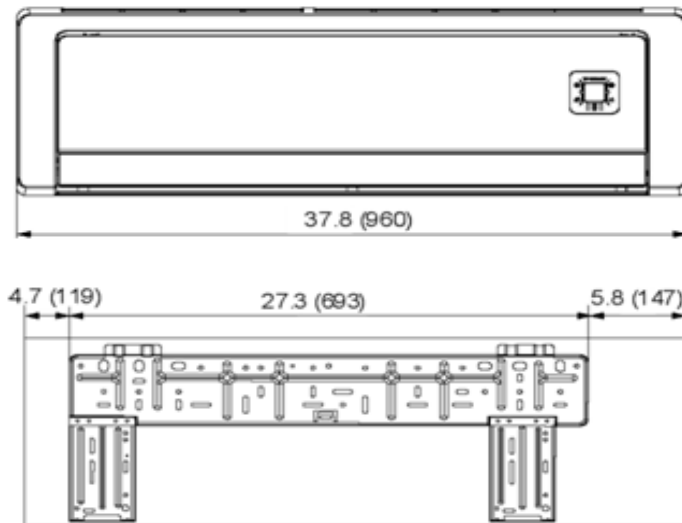

Liquid Line Valve	1/4-in OD Flared
Suction/Gas Line Valve	1/2-in OD Flared
Drain Connector	5/8-in OD

Note: Size Refrigerant lines based on evaporator port sizes.

Indoor Capacity Size	Fan (watts)	CFM (High)	Sound Power (Low/High)**
18,000 BTUH	20	488	35/46



www.greecomfort.com

**Sound Power ratings are per AHRI 270 and AHRI 350

COOLING CAPACITY (BTUH)

Indoor Units Combinations	Rated System Capacity (BtuH)	Capacity Rating (Min.~Max.) BtuH	Indoor Unit A (BtuH)	Indoor Unit B (BtuH)	Indoor Unit C (BtuH)	Indoor Unit D (BtuH)
9K+9K	18,000	6,824~26,600	9,000	9,000		
9K+12K	21,000	7,165~27,300	9,000	12,000		
12K+12K	24,000	7,200~30,000	12,000	12,000		
9K+18K	25,000	7,300~32,000	8,400	16,600		
12K+18K	25,500	7,400~32,500	10,000	15,000		
18K+18K	26,000	7,500~32,500	12,750	12,750		
9K+9K+9K	26,000	7,500~34,000	8,667	8,667	8,667	
9K+9K+12K	26,000	7,500~34,000	8,000	8,000	10,000	
9K+12K+12K	26,000	7,500~34,000	6,000	10,000	10,000	
9K+9K+18K	26,000	7,500~34,000	7,000	7,000	12,000	
12K+12K+12K	26,000	7,500~34,000	8,667	8,667	8,667	
9K+12K+18K	27,000	7,500~34,000	6,800	7,200	13,000	
12K+12K+18K	28,000	7,500~34,000	6,500	6,500	15,000	
9K+9K+9K+9K	29,000	7,500~34,000	7,250	7,250	7,250	7,250
9K+9K+9K+12K	29,000	7,500~34,000	7,000	7,000	7,000	8,000
9K+9K+12K+12K	29,000	7,500~34,000	6,800	6,800	7,700	7,700

HEATING CAPACITY (BTUH)

Indoor Units Combinations	Rated System Capacity (BtuH)	Capacity Rating (Min.~Max.) BtuH	Indoor Unit A (BtuH)	Indoor Unit B (BtuH)	Indoor Unit C (BtuH)	Indoor Unit D (BtuH)
9K+9K	19,000	7,100~33,000	9,500	9,500		
9K+12K	22,500	7,100~33,500	9,500	13,000		
12K+12K	26,000	7,200~34,000	13,000	13,000		
9K+18K	27,000	7,300~34,000	9,000	18,000		
12K+18K	28,000	7,400~34,000	11,200	16,800		
18K+18K	28,500	7,400~34,400	14,250	14,250		
9K+9K+9K	29,000	7,500~35,000	9,667	9,667	9,667	
9K+9K+12K	29,000	7,600~35,000	9,000	9,000	11,000	
9K+12K+12K	29,000	7,600~35,000	6,000	11,500	11,500	
9K+9K+18K	29,000	7,600~35,000	6,000	6,000	17,000	
12K+12K+12K	29,000	7,600~35,000	9,667	9,667	9,667	
9K+12K+18K	29,000	7,600~35,000	6,802	9,308	12,888	
12K+12K+18K	29,000	7,600~35,000	8,567	8,567	11,862	
9K+9K+9K+9K	30,500	7,600~36,000	7,625	7,625	7,625	7,625
9K+9K+9K+12K	30,500	7,600~36,000	7,100	7,100	7,100	9,200
9K+9K+12K+12K	31,000	7,600~36,000	6,500	6,500	9,000	9,000

Capacity data is based on the following conditions :

Cooling Nominal Test Conditions Heating Nominal Test Conditions

Indoor: 80°F DB/67°F WB

Indoor: 70°F DB/60°F WB

Outdoor: 95°F DB/75°F WB

Outdoor: 47°F DB/43°F W



Specifications are subject to change without notice. Manufacturer reserves the right to discontinue or modify specifications or designs without notice or without incurring obligations. All rights reserved.

COOLING PERFORMANCE

Outdoor Ambient Temperature (DB)	Indoor Entering Air Temperatures (DB) 50% RH					
	62 F		67 F		72 F	
	TC	SHC	TC	SHC	TC	SHC
25 F	35,679	26,492	38,564	27,920	41,224	29,681
35 F	34,867	26,460	37,132	27,106	38,935	28,150
45 F	33,144	25,454	35,444	26,300	37,976	27,532
55 F	31,909	24,697	34,026	25,519	36,476	26,628
65 F	30,821	23,948	33,913	25,740	35,960	26,287
75 F	29,609	23,154	31,900	24,531	34,310	25,320
85 F	28,420	22,565	30,450	23,507	33,060	24,696
95 F	26,970	21,549	29,000	23,171	31,726	23,826
105 F	25,520	20,722	27,486	21,934	29,870	22,940
115 F	24,068	19,832	25,518	20,669	27,258	21,343

HEATING PERFORMANCE

Outdoor Ambient Temperature (DB) (80% RH)	Indoor Entering Air Temperatures (DB)					
	65 F		70 F		75 F	
	TC	SHC	TC	SHC	TC	SHC
5 F	24,974	24,974	23,570	23,570	22,992	22,992
15 F	26,694	26,694	24,354	24,354	24,207	24,207
25 F	28,324	28,324	26,883	26,883	25,353	25,353
35 F	29,905	29,905	27,679	27,679	26,518	26,518
45 F	31,467	31,467	30,400	30,400	28,558	28,558
55 F	31,509	31,509	30,598	30,598	29,260	29,260
65 F	31,360	31,360	30,902	30,902	29,950	29,950

TC- Total Capacity (BtuH)

SHC- Sensible Capacity (BtuH)