



ENGLISH

ESPAÑOL



800-570-3355

OWNER'S MANUAL GAS COOKTOP

Please read this guide thoroughly before operating and keep it handy for reference at all times.

LSCG366ST
LSCG306ST

INTRODUCTION

IMPORTANT SAFETY INFORMATION

What to Do if You Smell Gas	3
Safety Precautions	4~5
Surface Burners.....	5~6

OPERATING INSTRUCTIONS

Using the Surface Burners	7~8
Using the Griddle	9

CARE AND CLEANING

Care and Cleaning	10
Burner Caps and Heads	11
Burner Grates	12
Cooktop Surface	12
Stainless Steel Surfaces	13
Control Knobs.....	13

TROUBLESHOOTING

Before Calling for Service	14
----------------------------------	----

WARRANTY

Product Registration Information	15
--	----

THANK YOU!

Congratulations on your purchase and welcome to the LG family. Your new LG built-in cooktop combines precision cooking features with simple operation and stylish design. By following the operating and care instructions in this manual, your cooktop will provide you with many years of reliable service.

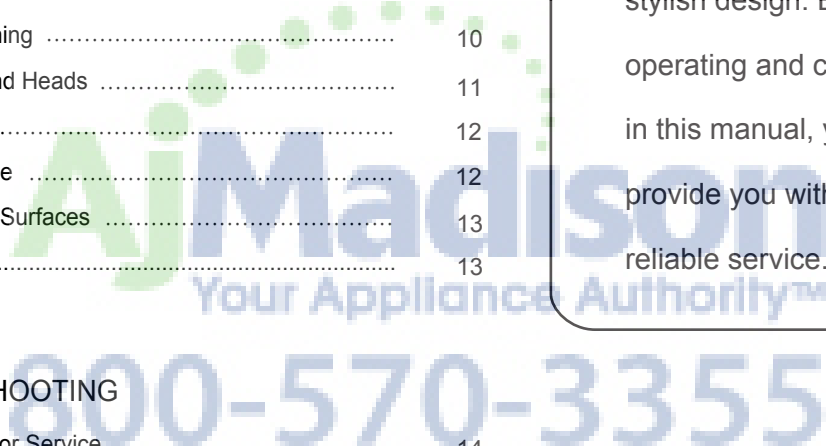

Product Registration Information

Model:
Serial Number:
Date of Purchase:

IMPORTANT SAFETY INFORMATION

READ ALL INSTRUCTIONS BEFORE USE

IMPORTANT SAFETY INSTRUCTIONS

Read and follow all instructions before using your oven to prevent the risk of fire, electric shock, personal injury, or or damage when using the range. This guide does not cover all possible conditions that may occur. Always contact your service agent or manufacturer about problems that you do not understand.



This is the safety alert symbol. This symbol alerts you to potential hazards that can kill or hurt you and other. All safety messages will follow the safety alert symbol and either the word “WARNING” or “CAUTION”. These word means :



WARNING

This symbol will alert you to hazards or unsafe practices which could cause serious bodily harm or death.



CAUTION

This symbol will alert you to hazards or unsafe practices which could cause bodily injury or property damage.



WARNING

For your safety, the information in ihis manual must be followed to minimize the risk of fire or explosion, electric shock, or to prevent event property to damage, personal injury, or death.



WARNING:

If the information in this manual is not followed exactly, a fire or explosion may result causing property damage, personal injury or death.

- Do not store or use gasoline or other flammable vapors and liquids in the vicinity of this or any other appliance.
- Stepping, leaning or sitting on this cooktop can result in serious injuries and cause damage to the cooktop.

WHAT TO DO IF YOU SMELL GAS

- Open window.
- Do not try to light any appliance.
- Do not touch any electrical switch.
- Do not use any phone in your building.
- Immediately call your gas supplier from a neighbor's phone.
- Follow the gas supplier's instructions.
- If you cannot reach your gas supplier, call the fire department.

Installation and service must be performed by a qualified installer, service agency or the gas supplier.

IMPORTANT SAFETY INFORMATION

READ ALL INSTRUCTIONS BEFORE USE

IMPORTANT SAFETY NOTICE

Enforcement Act requires the Governor of California to publish a list of substances known to the state to cause birth defects or other reproductive harm, and requires businesses to warn customers of potential exposure to such substances.

Gas appliances can cause minor exposure to four of these substances, namely benzene, carbon monoxide, formaldehyde and soot, caused primarily by the improper combustion of natural or LP gas.

Correctly adjusted burners, indicated by a blue rather than a yellow flame, will minimize improper combustion. Exposure to these substances can be minimized by opening windows or using a ventilation fan or hood.

SAFETY PRECAUTIONS

Let the installer show you the location of the cooktop gas shut-off valve and how to shut it off if necessary.

⚠ WARNING: These adjustments must be done by a qualified service technician according to the manufacturer's instructions and all codes and requirements of the authority having jurisdiction. Failure to follow these instructions could result in serious injury or property damage. The qualified agency performing this work assumes responsibility for the conversion.

- Make sure your cooktop is properly installed and grounded by a qualified installer, according to the Installation Instructions. Any adjustment and service should be performed only by qualified gas range installers or service technicians.
- Plug your cooktop into a 120-volt grounded outlet only. **Do not** remove the round grounding prong from the plug. If in doubt about the grounding of the home electrical system, it is your personal responsibility and obligation to have an ungrounded outlet replaced with a properly grounded, three-prong outlet in accordance with the National Electrical Code. **Do not** use an extension cord with this cooktop.
- To prevent fire hazard or electrical shock. Do not use an adapter plug, an extension cord, or remove grounding prong from electrical power cord. Failure to follow this warning can cause serious injury fire or death.
- To prevent poor air circulation, place the cooktop out of kitchen traffic path out of drafty locations.

- **Do not** attempt to repair or replace any part of your cooktop unless it is specifically mentioned in this manual. All other service should be referred to a qualified technician.
- Make sure all packaging materials are removed from the cooktop before operating it to prevent fire or smoke damage should the packaging material ignite.
- Make sure your cooktop is properly adjusted by a qualified service technician or installer for the type of gas (natural or LP) that is to be used. Your cooktop can be converted for use with either type of gas. See the Installation Instructions.
- **Do not** let children alone or unattended where a cooktop is hot or in operation. They could be seriously burned.

⚠ CAUTION: Items of interest to children should not be stored in cabinets above a cooktop—children climbing on the cooktop to reach items could be seriously injured.

- Storage on Appliance - Flammable materials should not be stored on the cooktop or near surface units. This includes paper, plastic and cloth items, such as cookbooks, plasticware and towels, as well as flammable liquids.
- **Do not** let anyone climb or stand on the cooktop. They could damage the cooktop and even tip over, causing severe personal injury.

IMPORTANT SAFETY INFORMATION

READ ALL INSTRUCTIONS BEFORE USE

SAFETY PRECAUTIONS (continued)

- Do not allow children to climb or play around the cooktop.

⚠ WARNING: NEVER use your cooktop as a space heater to heat or warm the room. Doing so may result in carbon monoxide poisoning and overheating of the cooktop.

- Never wear loose fitting or hanging garments while using the appliance. Be careful when reaching for items placed in cabinets over the cooktop. Flammable material could be ignited if brought into contact with flame or hot surfaces and may cause severe burns.
- Do not place flammable materials on or near the cooktop.
- Do not place or use combustible materials, gasoline or other flammable vapors and liquids in the vicinity of this or any other appliance.
- Do not place cooking oils or other flammable materials on or near the cooktop.
- Do not store explosives, such as aerosol cans, on or near the cooktop. Flammable materials may explode and result in fire or property damage.
- Do not use water on grease fires. NEVER touch a flaming pan. Turn the controls off. Smother a flaming pan on a surface burner by covering the pan completely with a well-fitting lid, cookie sheet or flat tray. Use a multi-purpose dry chemical or foam-type fire extinguisher. Flaming grease outside a pan can be put out by covering it with baking soda or, if available, by using a multi-purpose dry chemical or foam-type fire extinguisher.
- Let the burner grates and other surfaces cool before touching them or leaving them where children can reach them.
- Stepping, leaning or sitting on this cooktop can result in serious injuries and also cause damage to the cooktop.
- Clean the cooktop with caution. If a wet sponge or cloth is used to wipe spills on a hot cooktop, be careful to avoid steam burns.
- Not obstructing the flow of combustion and ventilation air.
- Leak testing of the appliance shall be conducted according to the manufacturer's instructions.

SURFACE BURNERS

⚠ WARNING

- If the top burner flame goes out, gas is still flowing to the burner until the knob is turned to the "OFF" position. Do not leave the burners "ON" unattended.
- Use proper pan size —Do not use pans that are unstable or easily tipped. Select cookware having flat bottoms large enough to cover burner grates. To avoid spills, make sure cookware is large enough to contain the food properly. This will save cleaning time and prevent hazardous accumulations of food. Since heavy spattering or spills left on a range can ignite, use pans with handles that can be easily grasped and remain cool.

- Never leave the surface burners unattended at high flame settings. Boiling overs can cause smoking. Smoking and greasy spillovers that may catch on fire.
- Always turn knobs to the "LITE" position when igniting the top burners and make sure the burners have ignited.
- Control the top burner flame size so it does not extend beyond the edge of the cookware. Excessive flame is hazardous.

IMPORTANT SAFETY INFORMATION

READ ALL INSTRUCTIONS BEFORE USE

SURFACE BURNERS (continued)

- Use only dry pot holders—moist or damp pot holders on hot surfaces may result in burns from steam.
Do not let pot holders come near open flames when lifting cookware.
Do not use a towel or other bulky cloth instead of a pot holder.
- If using glass cookware, make sure it is designed for top-of-range cooking.
- To prevent burns, ignition of flammable materials and spillage, turn cookware handles toward the side or back of the cooktop without extending over adjacent burners.
- NEVER place any items on the cooktop. The hot air from the vent may ignite flammable items and will increase pressure in closed containers, which may cause them to burst.
- Carefully watch foods being fried at a high flame setting.
- Always heat fat slowly, and watch as it heats.
- If frying combination of oils or fats, stir together before heating or as fats melt slowly.
- Use a deep fat thermometer if possible to prevent overheating fat beyond the smoking point.
- Use the least possible amount of fat for effective shallow or deep-fat frying.
Filling the pan too full of fat can cause spillovers when food is added.
- LG does not recommend using a gas cooktop for the preparation of flaming foods.
If you choose to prepare flaming foods under a hood, turn the fan on.
- Do not use a wok on the surface burners if the wok has a round metal ring that is placed over the burner grate to support the wok. This ring acts as a heat trap, which may damage the burner grate and burner head. Also, it may cause the burner to work improperly. This may cause a carbon monoxide level above that allowed by current standards, resulting in a health hazard.
- Foods for frying should be as dry as possible. Frest or moisture on foods can cause hot fat to bubble up and over the sides of the pan.
- Never try to move a pan of hot fat, especially a deep fat fryer. Wait until the fat is cool.
- Do not place plastic items on the cooktop—they may melt if left too close to the vent.
- Keep all plastics away from the surface burners.
- To prevent burns, always be sure that the controls for all burners are at the “OFF” position and all grates are cool before attempting to remove them.
- If you smell gas, turn off the gas to the cooktop and call a qualified service technician. Never use an open flame to locate a leak.
- Always turn knob to the “OFF” position before removing cookware.
- Do not lift the cooktop.
Lifting the cooktop can cause damage and improper operation of the cooktop.
- If the cooktop is located near a window, do not hang long curtains that could blow over the surface burners and catch on fire.

READ AND FOLLOW THIS SAFETY INFORMATION CAREFULLY.
SAVE THESE INSTRUCTIONS

OPERATING INSTRUCTIONS

USING THE GAS SURFACE BURNERS

Throughout this manual, features and appearance may vary from your model.

- Make sure all grates on the cooktop are properly placed before using any burner.
- Be sure the burners and grates are cool before you place your hand, a pot holder, cleaning cloths or other materials on them.
- Make sure all burners are in place.
- Do not operate the burner for an extended period of time without cookware on the grate. The finish on the grate may chip without cookware to absorb the heat.

HOW TO LIGHT A GAS SURFACE BURNER SEALED GAS BURNERS

- Be sure all the surface burners are placed in their respective positions.
- Push the control knob in and turn it to the LITE positions.
- You can hear a little **CLICKING** noise—the sound of the electric spark igniting the burners.
- To control the flame size, turn the knob. If the knob stays at LITE, it will continue to click.
- When turning a burner to LITE, all the burners spark. Do not attempt to disassemble or clean around any burner while another burner is on. An electric shock may result, which could cause you to knock over hot cookware.

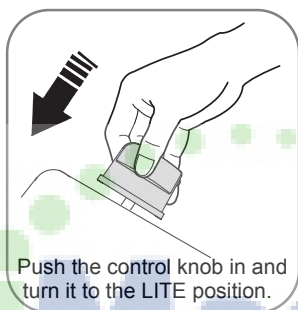

Your cooktop has five sealed gas burners. They offer convenience, cleanability and flexibility to be used in a wide range of cooking applications. The smallest burner is in the right rear.

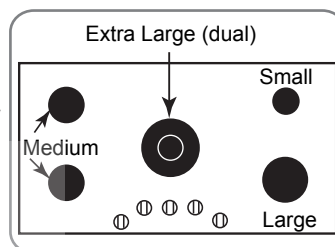

These burners can be turned down to LO for a very low simmer setting. They provide precise cooking performance for delicate foods such as sauces or food that requires low heat for a long cooking time.

The medium(left front & rear) and the large(right front) burners are the primary burners for most cooking. These general-purpose burners can be turned down from HI to LO suit a wide range of cooking needs.

The extra large burner (center) is the maximum output burner. Like the other four burners, it can be turned down from HI to LO for a wide range of cooking appliances.

This burner is also designed to quickly bring large amount of liquid to a boil. It has a special UltraHeat setting designed to be used with cookware 10 inches or large pots / pans or use with the griddle.

(LCG3691ST only)

The extra large burner(dual) can also be turned down to LO for a low simmer setting almost like the small burner.

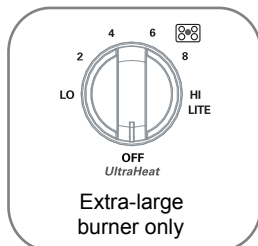

IN CASE OF POWER FAILURE

In case of a power failure, you can light the gas surface burners on your cooktop with a match. Hold a lit match to the burner, then push in and turn the control knob to the LITE position. Use extreme caution when lighting burners this way. Surface burners in use when an electrical power failure occurs will continue to operate normally.

OPERATING INSTRUCTIONS

USING THE GAS SURFACE BURNERS

HOW TO SELECT FLAME SIZE

NEVER let the flames extend up the sides of the cookware for safe handling of cookware.

Watch the flame, not the knob, as you reduce heat. When fast heating is desired, the flame size on a gas burner should match the cookware you are using.

Flames larger than the bottom of the cookware will not result in faster heating of the cookware and could be hazardous.

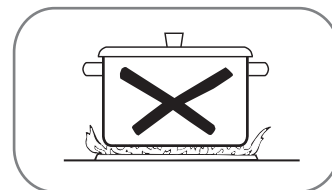

COOKWARE

Aluminum: Medium-weight cookware is recommended because it heats quickly and evenly. Most of the foods brown evenly in an aluminum skillet. Use sauce pans with tight fitting lids when cooking with minimum amounts of water.

Cast Iron: If heated slowly, most skillets will give satisfactory results.

Stainless Steel: This metal alone has poor heating properties and is usually combined with copper, aluminum or other metals for improved heat distribution. Combination metal skillets usually work satisfactorily if they are used with medium heat as the manufacturer recommends.

Enamelware: Under some conditions, the enamel of some cookware may melt. Follow cookware manufacturer's recommendations for cooking methods.

Glass: There are two types of glass cookware—those for oven use only and those for top of the range cooking (saucepans, coffee and teapots). Glass conducts heat very slowly.

Heatproof Glass Ceramic: Can be used for either surface or oven cooking. It conducts heat very slowly and cools very slowly. Check cookware manufacturer's directions to be sure it can be used on gas ranges.

USING A WOK

Do not use a wok support ring. Placing the ring over the burner or grate may cause the burner to work improperly, resulting in carbon monoxide levels above allowable standards.

This can be hazardous to your health.

We recommend that you use a 14 inch or smaller flat bottom wok. Make sure the wok bottom sits flat on the grate. They are available at your local retail store.

Only a flat-bottomed wok should be used.

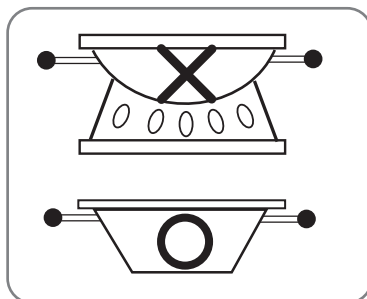

STOVE-TOP GRILLS

Do not use stove top grills on your surface burners. If you use the stove top grill on the surface burner, it will cause incomplete combustion and can result in exposure to carbon monoxide levels above allowable current standards.

This can be hazardous to your health.



OPERATING INSTRUCTIONS

USING THE GRIDDLE

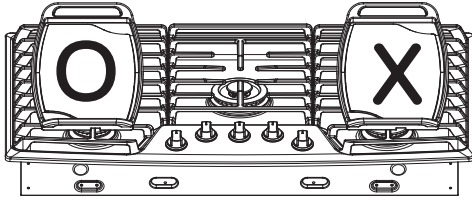

The griddle must only be used on the left side grate.

Your non-stick coated griddle provides an extra - large cooking surface for meats, pancakes or other food usually prepared in a frying pan or skillet.

NOTE: Your griddle will discolor over time as it becomes seasoned with use.

How to Place the Griddle: The griddle can only be used on the left side grate.

The griddle must be properly placed on the center grate.

NOTE: Do not remove the left side grate when using the griddle.

⚠ CAUTION: Do not remove the griddle plate until the cooktop grates, surfaces and griddle plate are completely cooled.

⚠ CAUTION: The griddle plate on the cooktop may become very hot when using the cooktop. Always use oven mitts when placing or removing the griddle plate.

IMPORTANT NOTES:

- Avoid cooking extremely greasy foods, grease spills can occur.
- The griddle can become hot when surrounding burners are in use.
- Do not overheat the griddle. This can damage the non stick coating.
- Do not use metal utensils that can damage the griddle surface. Do not cut foods on the griddle.
- Do not place or store items on the griddle.

CARE AND CLEANING OF THE COOKTOP

CARE AND CLEANING

Make sure electrical power is off and all surfaces are cool before cleaning any part of the cooktop.

SEALED BURNER ASSEMBLIES

Turn all controls OFF before removing the burner parts.

The burner grates, caps, and burner heads can be lifted off, making them easy to clean.

The electrodes are not removable.

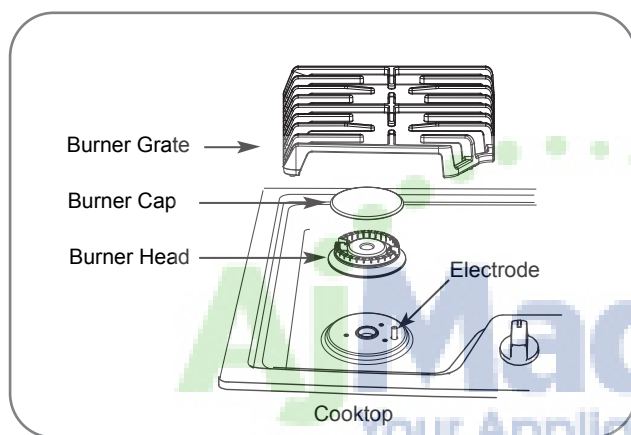

CAUTION: DO NOT remove any parts from the cooktop until they have completely cooled and are safe to handle. Do not operate the surface burners unless all burner parts and grates are properly placed.

The electrode of the burner is exposed when the burner head and cap are removed. When one burner is turned to LITE, all the burner spark. Do not attempt to disassemble or clean around any burner while another burner is on. An electric shock may result, which could cause you to knock over hot cookware.

DUAL EXTRA BURNER ASSEMBLY (on some models)

The burner head, the outer cap and the inner cap can be lifted off, making it easy to clean.

The burner electrode is not removable.

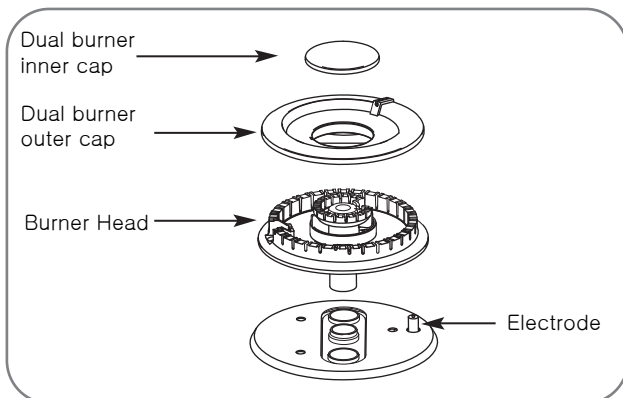

CARE AND CLEANING OF THE COOKTOP

BURNER CAPS AND HEADS

BURNER CAPS

Lift burner caps off when they are cool.
Wash burner caps in hot, soapy water and rinse with clean water. You may scour with a plastic scouring pad to remove burned-on food particles.

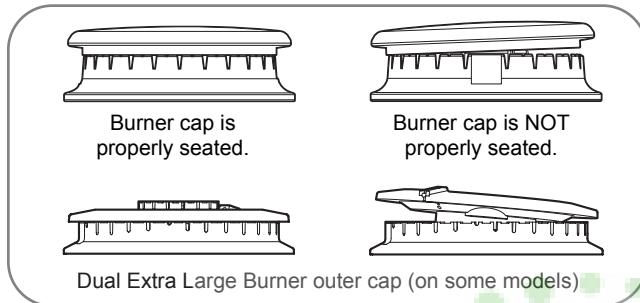

To get rid of burned-on food, soak the burner heads in a solution of mild liquid detergent and hot water for 20–30 minutes. For more stubborn stains, use a toothbrush.

NOTES:

- Do not use steel wool or scouring powders to clean the burners.
- Burners will not light if the cap is removed.

AFTER CLEANING

Before placing the burner caps and burner heads back, shake out excess water and then dry them thoroughly.

To place the dual extra large burner outer cap properly, make sure the slit in the burner cap is positioned over the assemble guide in the burner head.

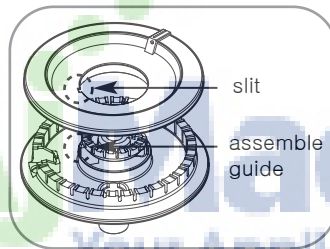

REPLACEMENT

Replace burner heads and caps over the electrodes on the cooktop, in the correct locations according to their size. There are one small, two medium, one large and one extra large burner head and cap.

BURNER HEADS

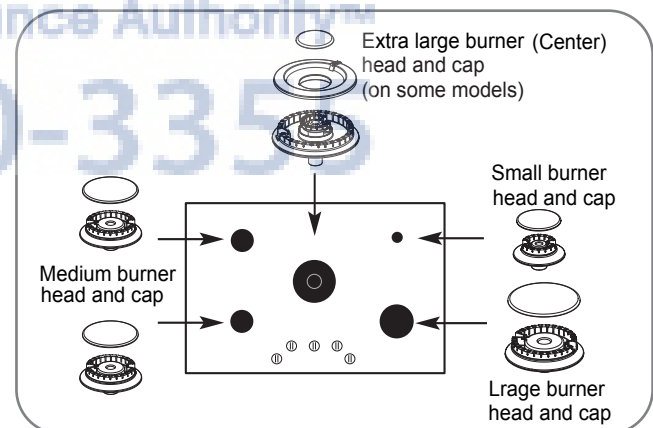
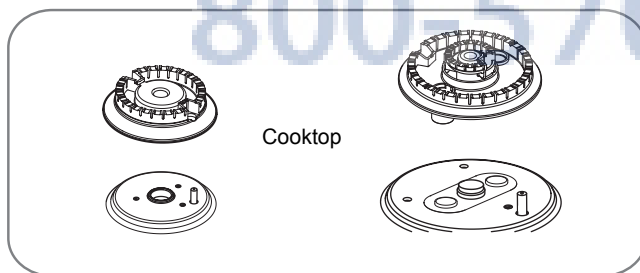

The burner heads are removable.
Simply lift them off the cooktop for cleaning.
The slits in the burner heads must be kept clean at all times for an even flame. Clogged or dirty burner ports or electrodes may cause improper operation of the cooktop.

Any spill on or around an electrode must be carefully cleaned. Take care to not hit an electrode with anything hard or it could be damaged.

You should clean the burner caps and heads routinely, especially after bad spillovers which could clog the openings. Lift burner heads off when they are cool.

CARE AND CLEANING OF THE COOKTOP

BURNER GRATES

Your cooktop has three professional-style grates. These grates are position-specific. For maximum stability, these grates should only be used in their proper position. Because of the varied burner sizes, the side grates cannot be exchanged nor can any of the grates be rotated front to back.

CLEANING

Lift grates off when they are cool. Grates should be cleaned regularly and, of course, after spills. Wash them in hot, soapy water and rinse with clean water. When replacing the grates, be sure they are positioned properly over the burners. Replace the grates so that continuous arcs are formed with the center ribs of all three grates. The grates may be cleaned in a dishwasher. Do not operate a burner for a long time without cookware on the grate. The finish on the grate may chip without cookware to absorb the heat. To remove burned-on food, place the grates in a covered container. Soak them with 1/4 cup ammonia for several hours or overnight. Wash, rinse well and dry.

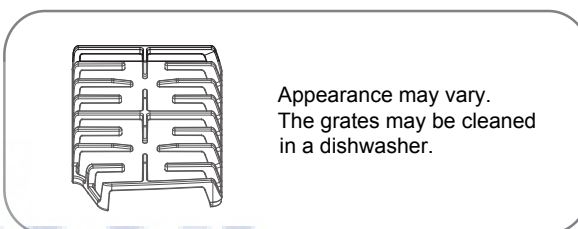
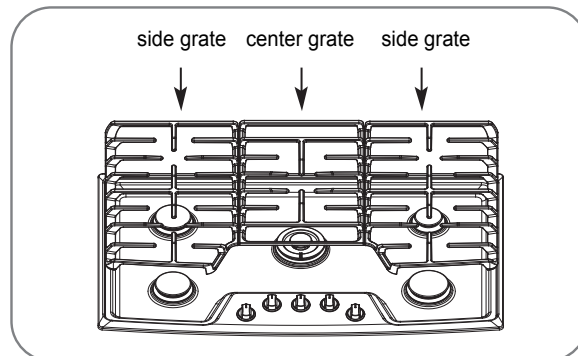

Although they are durable, the grates will gradually lose their shine, regardless of the best care you can give them. This is due to their continual exposure to high temperatures. You will notice this sooner with lighter color grates.

NOTE: Do not clean the grates in a self-cleaning oven.

COOKTOP SURFACE

To prevent damage to the stainless steel surface of the cooktop and to prevent it from becoming dull, clean up spills immediately. Foods with a lot of acid (such as tomatoes, sauerkraut, fruit juices, etc.) or foods with high sugar content could cause a dull spot if allowed to set. When the surface has cooled, wash and rinse.

For other spills such as fat splatterings, etc., wash with soap and water after the surface has cooled. Then rinse and polish by using a dry cloth.

NOTE: Do not place flammable materials on or near the cooktop. Do not store or use combustible materials, gasoline or other flammable vapors and liquids in the vicinity of this of any other appliance.

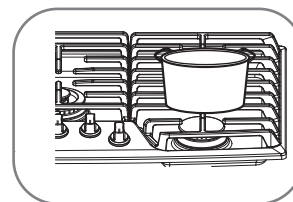

NOTE: Do not try to lift the cooktop. Lifting the cooktop can cause damage and improper operation of the cooktop.

CARE AND CLEANING OF THE COOKTOP

STAINLESS STEEL SURFACES

Do not use a steel wool pad; it will scratch the surface.

To clean the stainless steel surface, use warm soapy water or a stainless steel cleaner or polish. Always wipe the surface in the direction of the grain. Follow the cleaner instructions for cleaning the stainless steel surface.

To inquire about purchasing stainless steel appliance cleaner or polish, or to find the location of a dealer nearest you, please call our toll-free customer service number:

1-800-243-0000

or visit our website at:
us.lgservice.com

CONTROL KNOBS

It's a good idea to wipe the control panel after each use of the cooktop.

Clean or rinse the control panel by using a damp cloth.

Use mild soap and water or a 50/50 solution of vinegar and water. Use clean water for rinsing. Do not use abrasive cleansers, strong liquid cleaners, plastic scouring pads or oven cleaners on the control knobs - they can cause damage to the finish of the knobs.

Do not try to bend knobs by pulling them up or down or by hanging a towel or other such loads. This can damage the gas valve shaft.

The control knobs may be removed for easier cleaning.

Make sure the knobs are in the OFF position and pull them straight off the stems for cleaning.

To reinstall the knobs, make sure each the knob has the OFF position aligned and slide the knob directly onto the stem.

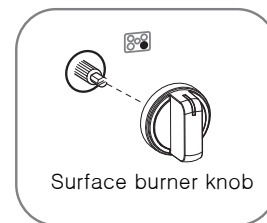



NOTE: To prevent mis-operation during cleaning the control knobs, Unplug your cooktop.

TROUBLESHOOTING

BEFORE CALLING FOR SERVICE

Before calling for service, review this list. It may save you time and expense. This list includes common occurrences that are not the result of a defect in workmanship or materials.

Problem	Possible Causes	Solutions
Burners have yellow or yellow-tipped flames	<ul style="list-style-type: none"> The combustion quality of burner flames needs to be determined visually. 	<ul style="list-style-type: none"> Use the illustrations below to determine if your burner flames are normal. If burner flames look like A, call for service. Normal burner flames should look like B or C, depending on the type of gas you use. With LP gas, some yellow tipping on outer cones is normal. <div style="display: flex; justify-content: space-around; align-items: flex-end;"> <div style="text-align: center;">  <p>A—Yellow flames Call for service</p> </div> <div style="text-align: center;">  <p>B—Yellow tips on outer cones Normal for LP gas</p> </div> <div style="text-align: center;">  <p>C—Soft blue flames Normal for natural gas</p> </div> </div>
Burner flames are very large or have yellow	<ul style="list-style-type: none"> Improper air to gas ratio. 	<ul style="list-style-type: none"> If cooktop is connected to LP gas, contact the person who installed your range or made the conversion.
Control knobs will not turn	<ul style="list-style-type: none"> Knob is not pushed down 	<ul style="list-style-type: none"> To turn from OFF position, push the knob down and then turn.
Top burners do not light or do not burn evenly.	<ul style="list-style-type: none"> Plug on cooktop is not completely inserted in the electrical outlet. Burner slots on the side of the burner may be clogged. Improper burner assembly. 	<ul style="list-style-type: none"> Make sure electrical plug is plugged into a live, properly grounded outlet. Remove the burners and clean them. Check the electrode area for burned-on food or grease. See the Care and Cleaning of the Cooktop section. Make sure the burner parts are installed correctly. See the Care and Cleaning of the Cooktop section.



LG Electronics, Inc. will repair or replace your product, at LG's option, if it proves to be defective in material or workmanship under normal use, during the warranty period set forth below, effective from the date of original consumer purchase of the product. This limited warranty is good only to the original purchaser of the product.

<p>WARRANTY PERIOD: LABOR: Two years from date of original purchase PARTS: Two years from date of original purchase</p> <p>WHAT IS COVERED: Any part of the range which fails due to a defect in materials or workmanship. During this full two-years warranty, LG will also provide, free of charge, all labor and in-home service to replace the defective part.</p>	<p>HOW SERVICE IS HANDLED: In-Home Service: Please retain dealer's dated bill of sale as evidence of the Date of Purchase for proof of warranty, and submit a copy of the bill of sale to the service person at the time warranty service is provided.</p> <p>Please call 1-800-243-0000 and choose the appropriate option to locate your nearest LG Authorized Service Center.</p> <p>Or visit our Web site at www.lgservice.com.</p>
--	--

THIS WARRANTY IS IN LIEU OF ANY OTHER WARRANTIES, EXPRESSOR IMPLIED, INCLUDING WITHOUT LIMITATION, ANY WARRANTY OF MERCHANTABILITY OR FITNESS FOR A PARTICULAR PURPOSE. TO THE EXTENT ANY IMPLIED WARRANTY IS REQUIRED BY LAW, IT IS LIMITED IN DURATION TO THE EXPRESS WARRANTY PERIOD ABOVE. LG WILL NOT BE LIABLE FOR ANY CONSEQUENTIAL, INDIRECT, OR INCIDENTAL DAMAGES OF ANY KIND, INCLUDING LOST REVENUESOR PROFITS, IN CONNECTION WITH THE PRODUCT. SOME STATES DO NOT ALLOW LIMITATION ON HOW LONG AN IMPLIED WARRANTY LASTS OR THE EXCLUSION OF INCIDENTAL OR CONSEQUENTIAL DAMAGES, SO THE ABOVE LIMITATIONS OR EXCLUSIONS MAY NOT APPLY TO YOU.

THIS LIMITED WARRANTY DOES NOT APPLY TO:

1. Service calls to correct the installation of your appliance, to instruct you how to use your appliance, to replace house fuses or correct house wiring, or to replace owner-accessible light bulbs.
2. Repairs when your appliance is used in other than normal, single-family household use.
3. Pickup and delivery. Your appliance is designed to be repairable in the home.
4. Damage resulting from accident, alteration, misuse, abuse, fire, flood, improper installation, acts of God, or use of products not approved by LG Corporation.
5. Repairs to parts or systems resulting from unauthorized modifications made to the appliance.
6. Replacement parts or repair labor costs for units operated outside the United States.
7. Any labor costs during the limited warranty period.

This warranty is extended to the original purchaser and any subsequent owner for products purchased for home use within the USA. In Alaska, the warranty excludes the cost of shipping or service calls to your home. Some states do not allow the exclusion or limitation of incidental or consequential damages, so this exclusion or limitation may not apply to you. This warranty gives you specific legal rights, and you may also have other rights which vary from state to state. To know what your legal rights are, consult your local or state consumer affairs or your state's Attorney General.

TO CONTACT LG ELECTRONICS BY MAIL:

LG Customer Interactive Center
P. O. Box 240007
201 James Record Road
Huntsville, Alabama 35824
ATTN: CIC



To contact LG Electronics,
24 hours a day, 7 days a week:
1-800-243-0000 (USA)
Or visit us on the Web at: us.lge.com
(USA)

Para comunicarse con LG Electronics,
24 horas al día, 7 días a la semana:
1-800-243-0000 (EE.UU.)
O visítenos en la Web en : us.lge.com
(EE.UU.)