



Installation

Your refrigerator was packed carefully for shipment. Remove and discard shelf packaging and tape. **Do not** remove the serial plate.

Location

- **Do not** install refrigerator near oven, radiator or other heat source. If not possible, shield refrigerator with cabinet material (contact a qualified contractor).
- **Do not** install where temperature falls below 55° F (12° C) or rises above 110° F (43° C). Malfunction may occur at this temperature.
- **Refrigerator is designed for indoor household application only.**

Measuring the Opening

When installing your refrigerator, measure carefully. Allow ½" space at top and ½" space behind the machine compartment cover (located in the rear) for proper air circulation.

Subflooring or floor coverings (i.e. carpet, tile, wood floors, rugs) may make your opening smaller than anticipated.

Some clearance may be gained by using the leveling procedure under *Leveling*.

Important: If refrigerator is to be installed into a recess where the top of the refrigerator is completely covered, use distance from floor to top of hinge cap to verify proper clearance.

Transporting Your Refrigerator

- **NEVER** transport refrigerator on its side. If an upright position is not possible, lay refrigerator on its back. Allow refrigerator to sit upright for approximately 30 minutes *before* plugging it in to assure oil returns to the compressor. Plugging the refrigerator in immediately may cause damage to internal parts.
- Use an appliance dolly when moving refrigerator. **ALWAYS** truck refrigerator from its side or back—**NEVER** from its front.
- Protect outside finish of refrigerator during transport by wrapping cabinet in blankets or inserting padding between the refrigerator and dolly.
- Secure refrigerator to dolly firmly with straps or bungee cords. Thread straps through handles when possible. **Do not** over-tighten. Over-tightening restraints may dent or damage outside finish.

Leveling

To enhance the appearance and maintain performance, the refrigerator should be leveled per instructions below.

⚠ CAUTION

To protect property and refrigerator from damage, observe the following:

- Protect vinyl or other flooring with cardboard, rugs, or other protective material.
- **Do not** use power tools when performing leveling procedure.

Notes:

- Complete any required water supply connection *before* leveling.
- Some models only have adjustment screws **(A)**.

Materials Needed:

- ⅜" hex head driver
- Carpenter's level.

1. Remove toe grille.

- Grasp firmly and pull outward to unclip.

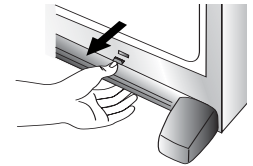

2. Using hex head driver, turn the front adjustment screws **(A)** on each side to raise or lower the front of the refrigerator (see illustration below).



3. Using the hex head driver, turn each of these adjustment screws **(B)** to raise or lower the rear of the refrigerator.
4. Using a carpenter's level, make sure front of refrigerator is ¼" (6 mm) or ½ bubble higher than back of refrigerator and that the refrigerator is level from side to side.
5. Turn stabilizing legs **(C)** *clockwise* until firmly against floor.
6. Turn adjustment screws **(A)** *counterclockwise* to allow the full weight of the refrigerator to rest on the stabilizing legs.
7. Replace the toe grille.
 - Align the toe grille mounting clips with the lower cabinet slots.
 - Push the toe grille firmly until it snaps into place.



Installation

Door and Drawer Removal

Some installations require door/drawer removal to transport the refrigerator to its final location.

⚠ WARNING

To avoid electrical shock which can cause severe personal injury or death, observe the following:

- Disconnect power to refrigerator *before* removing doors or drawer. Connect power only after replacing doors or drawer.

⚠ CAUTION

To avoid damage to walls and flooring, protect vinyl or other flooring with cardboard, rugs or other protective material.

Materials Needed:

- Phillips screwdriver
- $\frac{5}{16}$ " hex head driver
- $\frac{3}{8}$ " hex head driver

1. Unplug power cord from power source.
2. Remove toe grille and bottom bracket cover(s) (see page 3).
3. Remove top hinge cover from refrigerator door by removing Phillips screw and retain screw and cover for later use.
4. Unscrew $\frac{5}{16}$ " hex head screws from top hinge to remove hinge and retain all screws for later use.
5. Lift refrigerator door from center hinge pin.

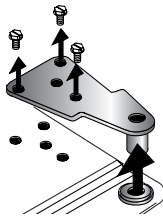
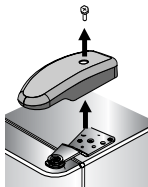

6. **For swing freezer door models only:** Hold freezer door while removing hinge pin with a $\frac{5}{16}$ " hex head driver. Remove door from bottom hinge and retain hinge pin for later use.

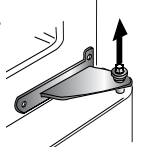

- For pullout freezer drawer models only:** Remove plastic sleeve, if present. Remove center hinge pin with a $\frac{5}{16}$ " hex head driver. Retain hinge pin and plastic sleeve for later use.

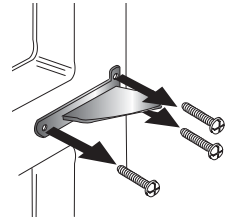

7. Remove Phillips screws to remove center hinge and retain all screws for later use.

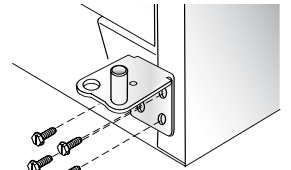

8. Remove bottom hinge or stabilizing bracket with $\frac{3}{8}$ " hex head driver and retain screws for later use. Lift out bottom hinge pin (on freezer door models).

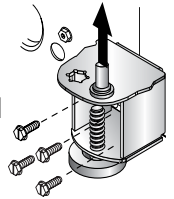

9. If your model has a pullout freezer drawer, see page 5 for drawer removal instructions.



Installation

Pullout Freezer Drawer (select models)

⚠ DANGER

To prevent accidental child entrapment or suffocation risk, **do not** remove the divider in the top freezer basket.

⚠ WARNING

To avoid electrical shock which can cause severe personal injury or death, disconnect power to refrigerator *before* removing doors. After replacing doors, connect power.

⚠ CAUTION

To avoid possible injury, product, or property damage, you will need two people to perform the following instructions.

Materials Needed:

- Phillips screwdriver

To Remove:

1. Pull drawer open to full extension.

2. Tilt the lower basket forward and lift to remove.



3. On each white drawer bracket is a basket cradle with two snap attachments. To release each cradle, unlatch the snaps by pushing them inward, away from the side bracket. Lift the cradles off of the rails.

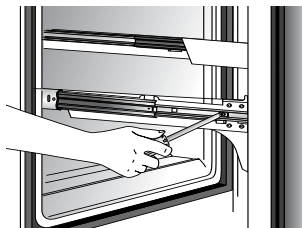

4. Remove Phillips screw from each of the drawer slides (select models).

5. Lift top of drawer front to unhook the drawer from the slides. Lift door front out to remove.

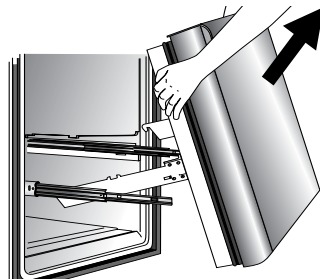

To Install:

1. Pull both rails out to full extension.
2. While supporting door front, hook supports into slots located on inside of each slide.

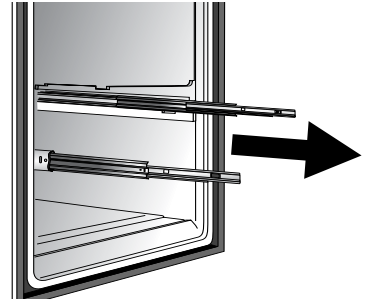

Note: All four drawer bracket supports must be in the proper slots for the drawer to function properly.

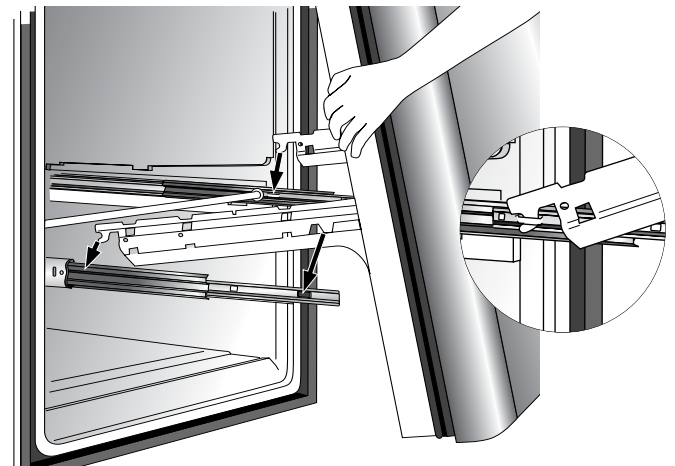

3. Lower door front into final position.

4. Replace and tighten Phillips screws that were removed from the drawer slides (select models).

5. Place the basket cradles back onto the drawer slides. Align basket cradle snaps with the slots on the drawer brackets and press each cradle toward the bracket until it clicks.

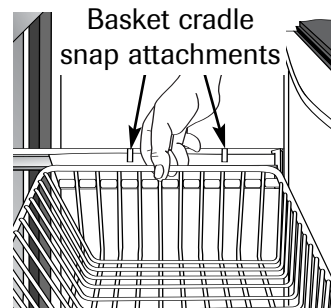

6. Tilt the lower basket front down and set it down into the basket cradles.



Installation

Reinstallation of the Doors

Materials Needed:

- Phillips screwdriver
- 5/16" hex head driver

1. Install hinge assemblies:

- Install top hinge loosely with 5/16" hex head screws.
- Install center hinge with Phillips screws.
- **Freezer door models:** Install bottom hinge with 3/8" hex head screws.

2. Freezer door models: Insert bottom hinge pin.

- Locate bottom hinge hole closest to outside edge of cabinet, and insert bottom hinge pin. Replace any door shims, if present.

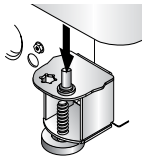

3. Freezer door models: Place hinge side of freezer door on bottom hinge pin and hold freezer door upright while installing center hinge pin with 5/16" hex head driver.

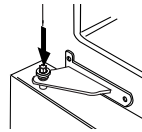

- Replace plastic sleeve.
- Replace any applicable door shims.
- Make sure the hinge pin is installed tightly.

4. Place hinge side of refrigerator door on center hinge pin.

5. While holding refrigerator door upright, tighten down top hinge with 5/16" hex head driver and replace hinge cover.

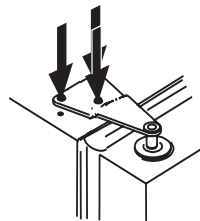

- Remove center mullion screws with 5/16" hex head screwdriver.
- **Freezer door models:** Remove bottom mullion screws with 3/8" hex head driver.

CAUTION

To avoid possible injury and damage to property:

- Place doors on a nonabrasive surface protected by towels or rugs while working directly on doors.

3. Transfer door stops from bottom edge of fresh food door and freezer door, if applicable, to opposite side of door edge.

- Use a Phillips screwdriver for removal and installation.

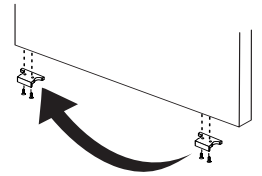

4. Install handles (see pages 6-8).

5. Reinstall the door(s).

Handles

Note: If not installed, the handle is located in the interior of the fresh food compartment or attached to the back of your refrigerator.

Remove and discard handle packaging and tape.

Handle design varies from refrigerator to refrigerator. Please reference the appropriate instructions for your model below.

Fresh Food Handles

Standard Front Mount Handle

Materials Needed:

- Phillips screwdriver
- 5/16" hex head driver

To Install:

1. Remove 1/4" hex head screws from door face with hex head driver, and Phillips screw from top of door.

- If reversing door, remove door plugs from opposite side of door and insert in screw holes.

2. Align handle holes with screw holes on door face and secure with two door face screws from step 1.

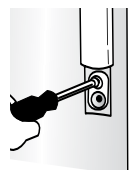
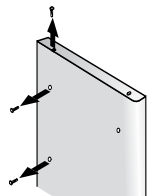

Door Reversal

In some installations, reversing the door swing allows for more convenient access to stored items. Both doors can be reversed on freezer *door* models and the fresh food door is reversible on freezer *drawer* models.

Materials Needed:

- Flat screwdriver
- Phillips screwdriver
- 5/16" hex head driver
- 3/8" hex head driver

1. Remove door(s) (see page 4).

2. Transfer cabinet plugs and cabinet screws to opposite side of cabinet.

- Remove cabinet plugs with flat blade of screwdriver tip wrapped in masking tape.

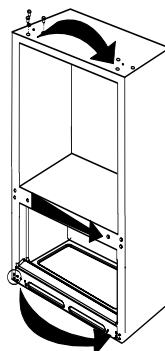



Installation

3. Locate handle trim in literature pack and install over top and bottom of handle, as illustrated.

- Secure top handle trim with remaining screw removed in step 1.
- Snap bottom trim over bottom portion of handle.

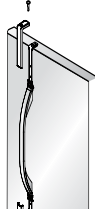

To Remove:

1. Remove top handle trim by removing top handle screw.
 - Retain trim and screw for later replacement.
2. Pry bottom handle trim from handle with screwdriver flat blade wrapped in masking tape.
 - Retain trim for later replacement.
3. Remove two hex head screws.
 - Retain screws for later replacement.

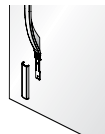
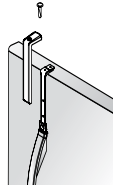

Side Mount Handle

Materials Needed:

- Phillips screwdriver

To Install:

1. Remove screws from the side of the door.
2. Align the side mount handle with the predrilled holes in the door panel.
3. Insert the screws in the sequence as shown.

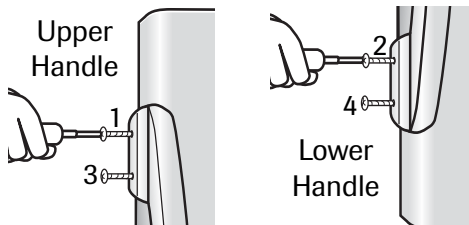
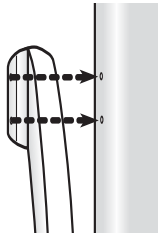

4. Ensure the door handle is snug to the door panel.

To Remove:

Reverse installation procedure.

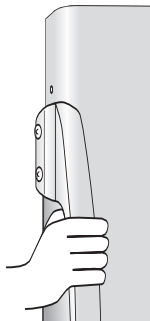

Freezer Handles

Partial-Width Handle

Materials Needed:

- Phillips screwdriver

To Install:

1. Install handle by fastening with screws removed from edge of door.
 - If reversing freezer door, remove door plugs from top edge of door and insert into screw holes.

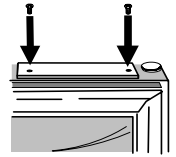

To Remove:

1. Remove handle screws with Phillips screwdriver and retain screws for later use.

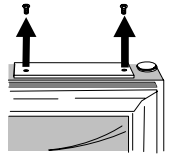

Front Mount Plastic Freezer Handle

Notes:

- There is a slight curve to this style of freezer handle.
- For proper installation, be sure handle is oriented as shown.

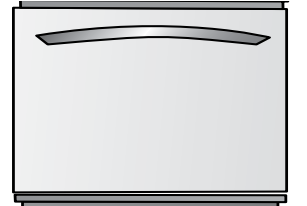

To Install:

1. Align door handle clips to the studs attached to the freezer door.
2. Ensure the large hole in the mounting clip is positioned to the *right* on both ends of the handle.
3. Rotate the handle so that the handle is flat against the door.
4. Grasp the handle firmly and slide handle to the *right*.

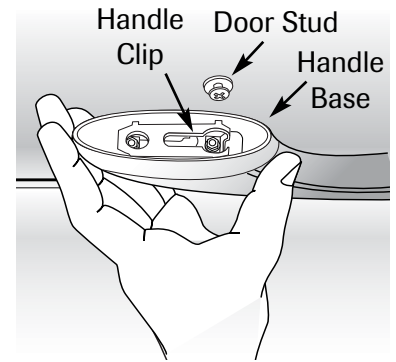

To Remove:

1. With both hands, firmly grasp the handle toward the right side.
2. Slide toward the *left*, lift and remove from the surface.



Installation

Metal Handle

Materials Needed:

- $\frac{3}{32}$ " Allen wrench
- Gloves to protect hands

Note: Metal handles can scratch doors.

To Remove:

- Loosen set screws in handle using $\frac{3}{32}$ " Allen wrench.
- Repeat the procedure on all screws.

To Replace:

- Align handle with the mounting posts.
- Apply upward pressure to the handle and hold.
- Fully tighten all set screws to secure handle in place.



Installation

Connecting the Water Supply (select models)

⚠ WARNING

To reduce the risk of injury or death, follow basic precautions, including the following:

- Read all instructions *before* installing ice maker.
- **Do not** attempt installation if instructions are not understood or if they are beyond personal skill level.
- Observe all local codes and ordinances.
- **Do not** service ice maker unless specifically recommended in Use & Care Guide or published user-repair instructions.
- Disconnect power to refrigerator *before* installing ice maker.
- Water damage due to an improper water connection may cause mold/mildew growth. Clean up spills or leakage immediately.

⚠ CAUTION

To avoid property damage or possible injury, follow basic precautions, including the following:

- Consult a plumber to connect $\frac{1}{4}$ " O.D. copper tubing to household plumbing to assure compliance with local codes and ordinances.
- Confirm water pressure to water valve is between 35 and 100 pounds per square inch. 20 pounds per square inch if there is not a water filter.
- **Do not** use a self-piercing, or $\frac{3}{16}$ " saddle valve. Both reduce water flow and can become clogged over time, and may cause leaks if repair is attempted.
- Tighten nuts by hand to prevent cross threading. Finish tightening nuts with pliers and wrenches. **Do not** over-tighten.
- Wait 2-3 hours *before* placing refrigerator into final position to check and correct any water leaks. Recheck for leaks after 24 hours.
- Verify the copper tubing under the sleeve is smooth and free from defects. **Do not** reuse an old sleeve.

Materials Needed:

- $\frac{1}{4}$ " outer diameter flexible copper tubing
- Shut-off valve (requires a $\frac{1}{4}$ " hole to be drilled into water supply line *before* valve attachment)
- Adjustable wrench (2)
- $\frac{1}{4}$ " hex nut driver

Notes:

- Use copper tubing only for installation. Plastic is less durable and can cause damage.
- Add 8' to tubing length needed to reach water supply for creation of service loop.

1. Create service loop with copper tubing (minimum 2' diameter). Avoid kinks in the copper tubing when bending the service loop. **Do not** use plastic tubing.

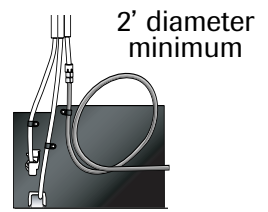

2. Remove plastic cap from water valve inlet port.

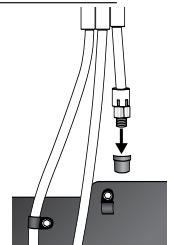

3. Place brass nut (A) and sleeve (B) on copper tube end as illustrated. **Reminder: Do not** use an old sleeve. The nut and sleeve are provided in the Use and Care packet.

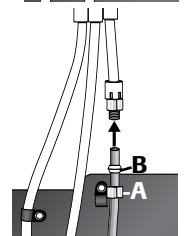

4. Place end of copper tubing into water valve inlet port. Shape tubing slightly. **Do not** kink – so that tubing feeds straight into inlet port.

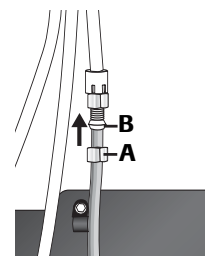



Installation

- Slide brass nut over sleeve and screw nut into inlet port.

Place adjustable wrench on nut **(1)** attached to plastic waterline and maintain position.

Using second adjustable wrench turn the lower nut **(2)** *counterclockwise* and fully tighten while holding the upper nut in place.

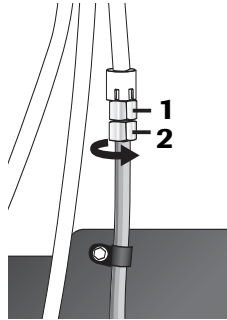

Important: Do not over-tighten. Cross-threading may occur.

- Pull on tubing to confirm connection is secure. Connect tubing to frame with water tubing clamp **(C)** and turn on water supply. Check for leaks and correct if necessary. Continue to observe the water supply connection for two to three hours prior to moving the refrigerator to its permanent location.

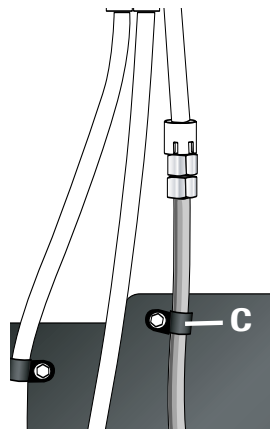

- Monitor water connection for 24 hours. Correct leaks, if necessary.

- Remove plastic cap from water valve inlet port.
- Place brass nut **(A)** and sleeve **(B)** on copper tube end as illustrated. **Reminder: Do not** use old sleeve. The nut and the sleeve are provided in the use and care packet.

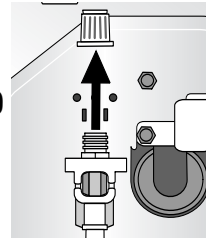

- Place end of copper tubing into water valve inlet port. Shape tubing slightly. **Do not** kink – so that tubing feeds straight into inlet port.

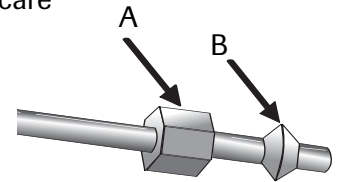

- Slide brass nut over sleeve and screw nut into inlet port. Tighten nut with wrench.

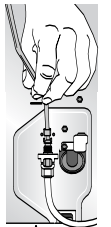

Important: Do not over-tighten. Cross threading may occur.

- Pull on tubing to confirm connection is secure. Connect tubing to frame with water tubing clamp **(C)** and turn on water supply. Check for leaks and correct if necessary. Continue to observe the water supply connection for two to three hours prior to moving the refrigerator to its permanent location.

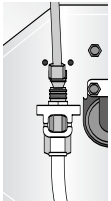

- Monitor water connection for 24 hours. Correct leaks, if necessary.

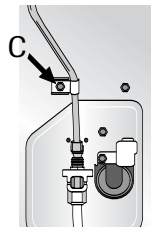

Alternate connection (select models)

Materials Needed:

- 1/4" outer diameter flexible copper tubing
- Shut-off valve (requires a 1/4" hole to be drilled into water supply line *before* valve attachment)
- Adjustable wrench
- 1/4" hex nut driver

Notes:

- Use copper tubing only for installation. Plastic is less durable and can cause damage.
- Add 8' to tubing length needed to reach water supply for creation of service loop.

- Create service loop with copper tubing (minimum 2' diameter). Avoid kinks in the copper tubing when bending the service loop. **Do not** use plastic tubing.

