

User Guide

Quality, Design and Innovation

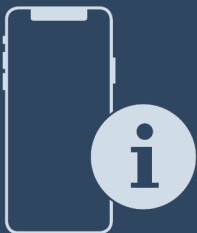

[home.liebherr.com/fridge-manuals](http://home.liebherr.com/fridge-manuals)

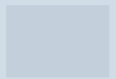

# LIEBHERR

# Contents

<b>1</b>	<b>The appliance at a glance.....</b>	<b>3</b>
1.1	Delivered contents.....	3
1.2	Overview of appliances and equipment.....	3
1.3	SmartDevice.....	4
1.4	Range of appliance use.....	4
1.5	Conformity.....	5
1.6	Spare parts.....	5
<b>2</b>	<b>General safety instructions.....</b>	<b>5</b>
<b>3</b>	<b>Functionality of the Touch &amp; Swipe display.....</b>	<b>7</b>
3.1	Navigation and symbol explanation.....	7
3.2	Menus.....	8
3.3	Sleep mode.....	9
<b>4</b>	<b>Start-up.....</b>	<b>9</b>
4.1	Switching on the appliance (first use).....	9
<b>5</b>	<b>Storage.....</b>	<b>9</b>
5.1	Information regarding storage.....	9
5.2	Storage sketches.....	10
<b>6</b>	<b>Energy saving.....</b>	<b>10</b>
<b>7</b>	<b>Use.....</b>	<b>11</b>
7.1	Control and display elements.....	11
7.1.1	Status display.....	11
7.1.2	Display symbols.....	11
7.1.3	Acoustic signals.....	12
7.2	Appliance functions.....	12
7.2.1	Notes on the appliance functions.....	12
7.2.2	Switching appliance on and off .....	12
7.2.3	WiFi .....	12
7.2.4	Temperature .....	13
7.2.5	Temperature unit .....	14
7.2.6	SabbathMode .....	14
7.2.7	HumiditySelect .....	15
7.2.8	Presentation light .....	15
7.2.9	Display Brightness .....	16
7.2.10	Door alarm .....	16
7.2.11	Alarm Sound.....	16
7.2.12	Display lock.....	17
7.2.13	Access codes.....	17
7.2.14	Language .....	19
7.2.15	Appliance information .....	19
7.2.16	Software .....	19
7.2.17	Reminder .....	20
7.2.18	Demo mode .....	20
7.2.19	Resetting to factory settings .....	21
7.3	Messages.....	21
7.3.1	Warnings.....	21
7.3.2	Reminders.....	22
<b>8</b>	<b>Equipment.....</b>	<b>23</b>
8.1	Safety lock.....	23
8.2	Description labels.....	23
8.3	Water box.....	23
<b>9</b>	<b>Maintenance.....</b>	<b>24</b>
9.1	Air exchange through the FreshAir activated charcoal filter.....	24
9.2	Cleaning the appliance.....	25

<b>10</b>	<b>Customer support.....</b>	<b>26</b>
10.1	Technical specifications.....	26
10.2	Operating noises.....	26
10.3	Technical faults.....	27
10.4	Customer Service.....	28
10.5	Rating plate.....	28
<b>11</b>	<b>Decommissioning.....</b>	<b>28</b>
<b>12</b>	<b>Disposal.....</b>	<b>28</b>
12.1	Preparing the appliance for disposal.....	28
12.2	Disposing of the appliance in an environmentally friendly manner.....	29





Congratulations on the purchase of your new appliance. With this purchase, you have chosen all the advantages of the latest refrigeration technology, guaranteeing you a high-quality appliance with a long life span and high operating safety.

The equipment of your appliance gives you the highest level of day-to-day ease of operation.

Together we are making an active contribution to the conservation of our environment by purchasing this appliance which is manufactured in an environmentally friendly process with the use of recyclable materials.

We hope you enjoy your new appliance.

The manufacturer is constantly working to improve all types and models. Therefore, please be aware that we reserve the right to make changes to the shape, equipment and technology.

Symbol	Explanation
	<b>Read instructions</b> Please read the information in these instructions carefully to understand all of the benefits of your new appliance.
	<b>Additional information online</b> The digital manual with supplemental information can be found online by scanning the QR code on the front page of this manual or by entering the service number at <a href="http://home.liebherr.com/fridge-manuals">home.liebherr.com/fridge-manuals</a> .
	<b>Check appliance</b> Check all parts for transport damage. If you have any complaints, please contact your agent or customer service.
	<b>Differences</b> These instructions apply to a range of models, so there may be differences. Sections that apply to certain models only are indicated by an asterisk (*).
	<b>Instructions and results</b> Instructions are marked with a ▶. Results are marked with a ▷.

Symbol	Explanation
	<b>Videos</b> Videos about the appliances are available on the YouTube channel of Liebherr-Hausgeräte.

## Open-source licenses:

The appliance includes software components that make use of open-source licenses. You can find information on the open-source licenses to be used here: [home.liebherr.com/open-source-licenses](https://home.liebherr.com/open-source-licenses)

These operating instructions apply to:

W.5270 / 7470

## 1 The appliance at a glance

### 1.1 Delivered contents

Check all parts for transport damage. If you have any complaints, please contact the retailer or customer service. (see 10.4 Customer Service)

Delivery contains the following parts:

- Standalone appliance
- Equipment (depending on your model)
- Installation parts (depending on your model)
- User Guide
- Installation Guide
- Warranty documents

## 1.2 Overview of appliances and equipment

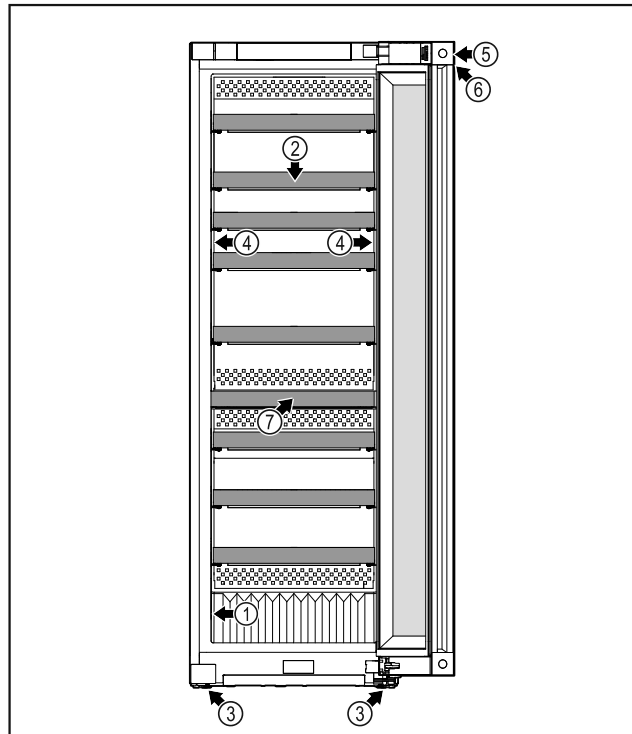

Fig. 1 WP. 5272 / 7472 / 5262 / W5270

- |                              |   |
|------------------------------|---|
| <b>(1)</b> Type plate        | <b>(5)</b> Lock                                     |
| <b>(2)</b> Wooden grid shelf | <b>(6)</b> Control elements and temperature display |
| <b>(3)</b> Adjustable feet   | <b>(7)</b> Activated charcoal filter                |
| <b>(4)</b> Interior lighting |   |

# The appliance at a glance

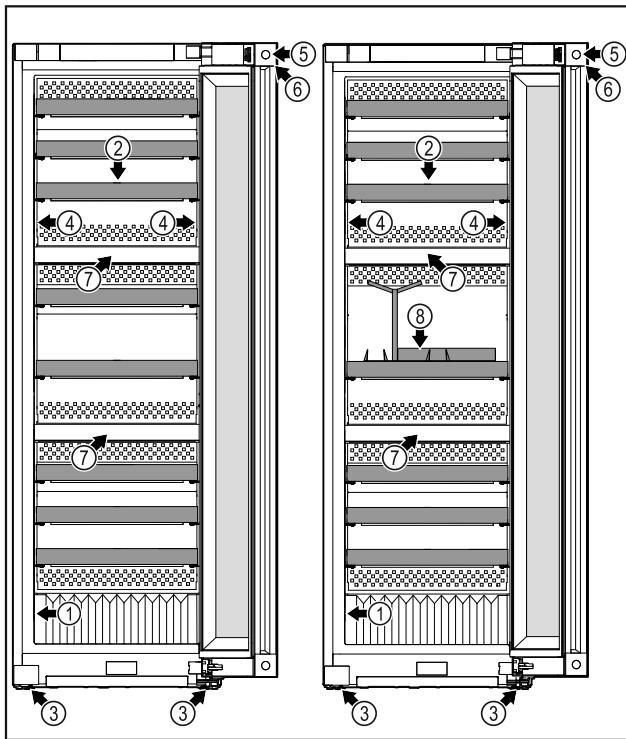

Fig. 2 WP.. 5273 / 7473

- (1) Type plate
- (2) Wooden grid shelf
- (3) Adjustable feet
- (4) Interior lighting

WP.. 5283 / 7483 / Wgb7470

- (5) Lock
- (6) Control elements and temperature display
- (7) Activated charcoal filter
- (8) Sommelier set\*

## 1.3 SmartDevice

SmartDevice is the networking solution for your wine storage cabinet.

If your appliance is SmartDevice-enabled or compatible, you can quickly and easily connect your appliance to your WiFi. With the SmartDevice app, you can operate your appliance from a mobile device. Additional functions and setting options are available in the SmartDevice app.

SmartDevice-enabled appliance:

Your appliance is capable of being a SmartDevice. To be able to connect your device to WiFi, you need to download the SmartDevice app.



More information about SmartDevice: [smartdevice.liebherr.com](http://smartdevice.liebherr.com)

Downloading the SmartDevice app:



After installing and configuring the SmartDevice app, you can connect your appliance to the WiFi using the SmartDevice app and the WiFi appliance function (see 7.2.3 WiFi).

## 1.4 Range of appliance use

### Normal use

- staff kitchen areas in shops, offices and other working environments;
- farm houses and by clients in hotels, motels and other residential type environments;
- bed and breakfast type environments;
- catering and similar non-retail applications.

The appliance is not suitable for freezing food; The appliance is not suitable as a built-in unit; All other types of uses are not permitted.

### Foreseeable misuse

The following uses are specifically prohibited:

- Storage and cooling of medication, blood plasma, laboratory preparations or similar substances and products in accordance with the CMDCAS and FDA 510(k)
- Use outdoors
- Use in moist areas exposed to the rain
- Use in areas at risk of explosion

Incorrect appliance use can cause damage to the stored products or cause them to spoil.

### Climate ratings

The appliance is set to operate within specific ambient temperature limits according to its climate rating. The climate rating for your appliance is printed on the rating plate.

### Note

► To guarantee trouble-free operation, comply with the indicated ambient temperatures.

Climate rating	for ambient temperatures from
SN	10 °C (50 °F) to 32 °C (90 °F)
N	16 °C (61 °F) to 32 °C (90 °F)

Climate rating	for ambient temperatures from
ST	16 °C (61 °F) to 38 °C (100 °F)
T	16 °C (61 °F) to 43 °C (109 °F)
SN-ST	10 °C (50 °F) to 38 °C (100 °F)
SN-T	10 °C (50 °F) to 43 °C (109 °F)

## 1.5 Conformity

The refrigerant circuit has been tested for leaks. The appliance complies with the applicable safety regulations and with the corresponding directives.

Since there are no energy efficiency guidelines for wine cooling appliances, wine compartments are considered to be cellar compartments for assignment to an energy efficiency class.

## 1.6 Spare parts

Spare parts for functional and storable parts of the equipment are available for 15 years.

## 2 General safety instructions

Please keep these operating instructions in a safe place so you can refer back to them at any time.

If you pass the appliance on, please hand these operating instructions to the new owner.

Read and follow these instructions. They contain safety information which is important for safe and problem-free installation and operation. Always read and follow the safety information.

### Dangers for the user:

- This appliance is not intended for use by persons (including children) with reduced physical, sensory or mental capabilities, or lack of experience and knowledge, unless they have been given supervision or instruction concerning use of the appliance by a person responsible for their safety. Children should be supervised to ensure that they do not play with the appliance. Cleaning and user maintenance must not be performed by children unless they are supervised. Children between the ages of 3 and 8 may load and unload the appliance. Children under the age of 3 must be kept away from the appliance unless they are constantly supervised.

- **IMPORTANT:** The power plug must be easily accessible so that the appliance can be disconnected from the mains quickly in an emergency. It must not be behind the back of the appliance.
- The socket must be easily accessible so that the appliance can be disconnected quickly from the electricity in an emergency. It must not be located in the area behind the appliance.
- Always hold the appliance at the plug when disconnecting it from the household power. Do not pull on the cable.
- Disconnect the power plug or fuse if there is a malfunction.
- Do not damage the power cable. Do not operate the appliance with a faulty power cable. If the supply cord is damaged, it must be replaced by the manufacturer, its service agent or similarly qualified persons in order to avoid a hazard. For Plug and Play connections, the change may be carried out by the customer.
- Repairs and work on the appliance may only be carried out by Customer Service or other specifically trained qualified personnel.
- Always follow the instructions when assembling, connecting and disposing of the appliance.

### Risk of fire:

- The refrigerant contained within the appliance (specifications on the identification plate) is environmentally friendly, but flammable. Leaking refrigerant can ignite.
  - **WARNING:** Do not damage the refrigerant circuit.
  - Do not handle ignition sources inside the appliance.
  - **WARNING:** Do not use electrical appliances inside the food storage compartments of the appliance, unless they are of the type recommended by the manufacturer (e.g. steam cleaning appliances, heating appliances, ice cream makers).
  - If refrigerant leaks: Remove naked flames or ignition sources located near the area of the leak. Ventilate the room well. Contact Customer Service.
- Do not operate the appliance near explosive gases.

## General safety instructions

---

- Do not store or use gasoline or other flammable gases and liquids near the appliance.
- Do not store explosive substances such as aerosol cans with a flammable propellant in this appliance. You can recognize such spray cans by the printed list of contents or by a flame symbol. Any leaking gases can be ignited by electrical components.
- Keep lit candles, lamps and other objects with naked flames away from the appliance so they do not cause a fire.
- Alcoholic beverages or other containers holding alcohol must always be tightly sealed for storage purposes. Any leaking alcohol can be ignited by electrical components.

### Risk of falling or toppling over:

- **WARNING:** To avoid a hazard due to instability of the appliance, it must be fixed in accordance with the instructions.
- Do not stand on the base, drawers, doors etc. or use them as improper supports. This applies in particular to children.

### Danger of poisoning:

- Do not consume spoiled food.

### Danger of frostbite, feeling of numbness and pain:

- Avoid prolonged skin contact with cold surfaces or chilled/frozen food or take protective measures, e.g. wear gloves.

### Risk of injury and damage:

- Hot steam may cause injuries. Do not use any electrical heating or steam cleaning equipment, naked flames or defrosting sprays for defrosting measures.
- **WARNING:** Do not use mechanical devices or other means to accelerate the defrosting process, other than those recommended by the manufacturer.
- Do not remove ice using sharp objects.
- **WARNING:** Keep clear of obstruction all ventilation openings in the appliance enclosure or in the structure for building-in.
- **WARNING:** Risk of child entrapment. Before you throw away your old refrigerator or freezer:
  - Take off the doors.
  - Leave the shelves in place so that children may not easily climb inside.

### Risk of crushing:

- Do not hold onto the hinge when opening and closing the door. Fingers may become trapped.

### California Proposition 65

- **WARNING:** This product can expose you to chemicals including Diisononyl Phthalate (DINP), which is known to the State of California to cause cancer, and Di-isodecyl Phthalate (DIDP), which is known to the State of California to cause birth defects or other reproductive harm. For more information, go to [www.P65Warnings.ca.gov](http://www.P65Warnings.ca.gov)

### FCC Warning

- Changes or modifications not expressly approved by the party responsible for compliance could void the user's authority to operate the equipment.

### FCC information

- This appliance has been tested and found to comply with the limits for a Class B digital device, pursuant to part 15 of the FCC Rules. These limits are designed to provide reasonable protection against harmful interference from an installation in residential areas. This appliance generates, uses and can radiate radio-frequency energy and, if not installed and used in accordance with the instructions, may cause harmful interference to radio communications. However, there is no guarantee that interference will not occur in a particular installation. If this appliance does cause harmful interference to radio or television reception, which can be determined by switching the appliance on and off, the user should try to correct the interference by one or more of the following measures:
  - Reorient or relocate the receiving antenna.
  - Increase the distance between the appliance and receiver.
  - Connect the appliance to an outlet on a circuit different from that to which the receiver is connected.
  - Consult the dealer or an experienced radio/TV technician for help.

### FCC Radio Frequency Exposure Statement

- This appliance is found to comply with FCC radio frequency (RF) exposure limits set for

## Functionality of the Touch & Swipe display

an uncontrolled environment. This transmitter must not be set up or operated in conjunction with another antenna or another transmitter.

- This appliance should be installed and operated with a minimum space of 200 mm (7 7/8 in) between the antenna and your body. The user must follow the specific operating instructions to ensure compliance with RF exposure.

### IC information

- This appliance has license-exempt transmitters/receivers, which comply with the license-exempt Radio Standards Specification (RSS) of Innovation, Science and Economic Development Canada. Operation is subject to the following two conditions:
  - This appliance may not cause interference.
  - This device must accept any interference, including interference that may cause undesired operation of the device.

### IC Radio Frequency Exposure Statement

- This appliance meets the IC RSS-102 limits for radiation exposure, which were defined for an uncontrolled environment. This appliance should be installed and operated so that there is a minimum space of 200 mm (7 7/8 in) between the antenna and your body.

### Symbols on the device:



The symbol may be located on the compressor. It refers to the oil in the compressor and refers to the following danger: Can be fatal if swallowed or inhaled. This notice only applies for recycling. There is no danger during normal operation.



**WARNING:** Risk of fire / flammable materials. The symbol is located on the compressor and indicates the danger from flammable materials. Do not remove the label.



This label or a similar one may be located on the rear of the appliance. This label indicates that there are vacuum insulation panels (VIP) or perlite panels in the door and/or housing. This notice only applies for recycling. Do not remove the label.

### Observe the warning messages and other detailed information in the other sections:

	DANGER	Indicates an immediately hazardous situation, which if not avoided, will result in death or serious injury.
	WARNING	Indicates a hazardous situation, which if not avoided, could result in death or serious injury.
	CAUTION	Indicates a hazardous situation, which if not avoided, could result in minor or moderate injury.
	NOTICE	Indicates a hazardous situation, which if not avoided, could result in damage to property.
	Note	Indicates useful advice and tips.

## 3 Functionality of the Touch & Swipe display





You operate your appliance using the Touch & Swipe display. You select appliance functions in the Touch & Swipe display (hereafter referred to as display) by tapping them. If you do not perform any action on the display for 10 seconds, the display either jumps back to the higher-level menu or directly to the status display.

### 3.1 Navigation and symbol explanation

In the illustrations, different symbols are used to navigate the display. The following table describes these symbols.

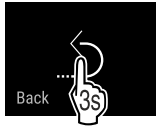
Symbol	Description
	<b>Briefly touch the display:</b> Activates/deactivates function. Confirms selection. Opens submenu.
	<b>Touch the display for a specified time (e.g. 3 seconds):</b> Activates/deactivates function or value.
	<b>Swipe left or right:</b> Navigate in the menu.

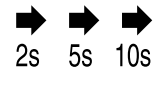

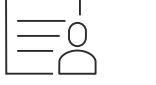
# Functionality of the Touch & Swipe display

Symbol	Description
	<b>Briefly touch the Back symbol:</b> Jumps back one menu level.
	<b>Press and hold the Back symbol for 3 seconds:</b> Jumps back to the status display.
	<b>Briefly touch the Back symbol at the top left:</b> Jumps back one menu level.
	<b>Arrow with clock:</b> It takes more than 10 seconds for the following message to appear in the display.
	<b>Arrow with a time indication:</b> It takes the specified amount of time until the following message appears in the display.
	<b>“Open Settings menu” symbol:</b> Navigates to the Settings menu and opens the settings menu. If necessary: Navigate to the desired function in the Settings menu. (see 3.2.1 Opening the Settings menu)
	<b>“Open Advanced menu” symbol:</b> Navigates to the Advanced menu and opens the advanced menu. If necessary: Navigate to the desired function in the Advanced menu. (see 3.2.2 Opening expanded menu)
No action for 10 seconds	If you do not perform any action on the display for 10 seconds, the display either jumps back to the higher-level menu or directly to the status display.
Open door and close it again.	If you open the door and immediately close it again, the display jumps directly back to the status display.

Note: Illustrations of the display are shown in the English version.

## 3.2 Menus

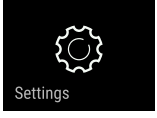
The appliance functions are distributed over various menus:

Menu	Description
Main menu	When you switch the appliance on, you are automatically in the main menu. From here you can navigate to the most important appliance functions, to the Settings menu and to the Advanced menu.
 Settings menu	The Settings menu contains additional appliance functions for setting up your appliance.
 Advanced menu	The advanced menu contains special appliance functions for setting up your appliance. Access to the Advanced menu is protected by the numerical code <b>151</b> .

### 3.2.1 Opening the Settings menu

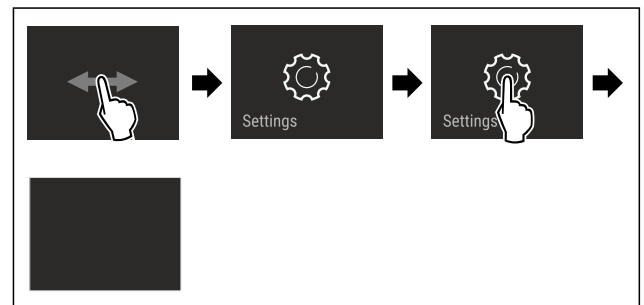

Fig. 3 Example illustration

- ▶ Carry out action steps according to the illustration.
- ▷ Settings menu is open.
- ▶ If necessary: Navigate to the desired function.

### 3.2.2 Opening expanded menu

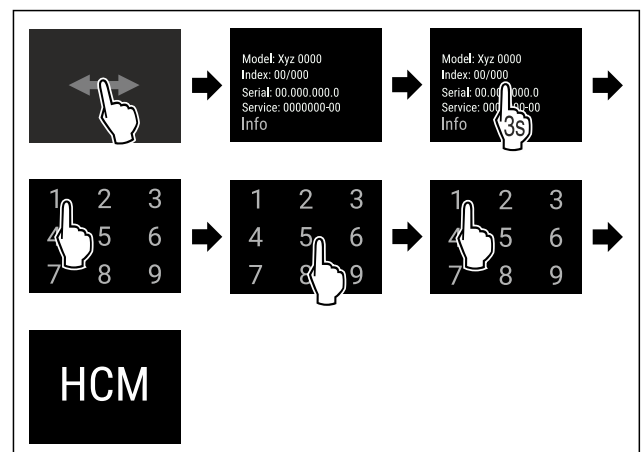

Fig. 4 Access with numerical code **151**

- ▶ Carry out action steps according to the illustration.
- ▷ Expanded menu is open.

- ▶ If necessary: Navigate to the desired function.

## 3.3 Sleep mode

If you do not touch the display for 1 minute, the display switches to sleep mode. In sleep mode, the display brightness is dimmed.

### 3.3.1 Ending sleep mode

- ▶ Touch the display briefly with your finger.
- ▷ Sleep mode is ended.

## 4 Start-up

### 4.1 Switching on the appliance (first use)

Make sure that the following requirements are fulfilled:

- Appliance is set up and connected.
- All adhesive strips, adhesive and protective films and transport locks are removed from inside and outside the appliance.

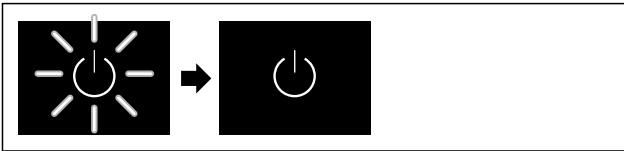

Fig. 5 Example illustration

- ▶ Standby symbol appears is flashing: Wait until the start process has completed.
- ▷ Display shows the standby symbol.

If the appliance has been supplied with factory settings, the screen language and the date/time first need to be set when using the appliance for the first time.

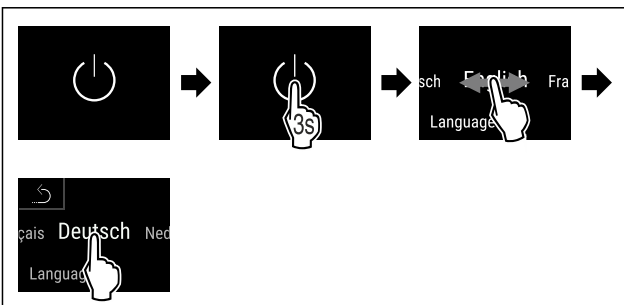

Fig. 6

- ▶ Carry out action steps according to the illustration.
- ▷ Language is set.

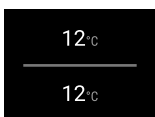

Fig. 8 Status display

- ▷ The appliance is ready for use once the temperature appears in the display.

- ▷ The temperature display flashes until the set temperature is reached.

## 5 Storage

### 5.1 Information regarding storage



#### WARNING

Danger of fire

- ▶ Do not use electrical appliances inside the food storage compartments of the appliance, unless they are of the type recommended by the manufacturer.

#### Note

Insufficient ventilation results in an increase in energy consumption and reduction of the refrigerating performance

- ▶ Always keep the air slots unobstructed.

Observe the following specifications for storage:

- Keep liquids in closed containers.
- Position storage shelves according to the height required.
- Observe maximum load weight. (see 10.1 Technical specifications)

# Energy saving

## 5.2 Storage sketches

### 5.2.1 WP / WS 5252 / W5250

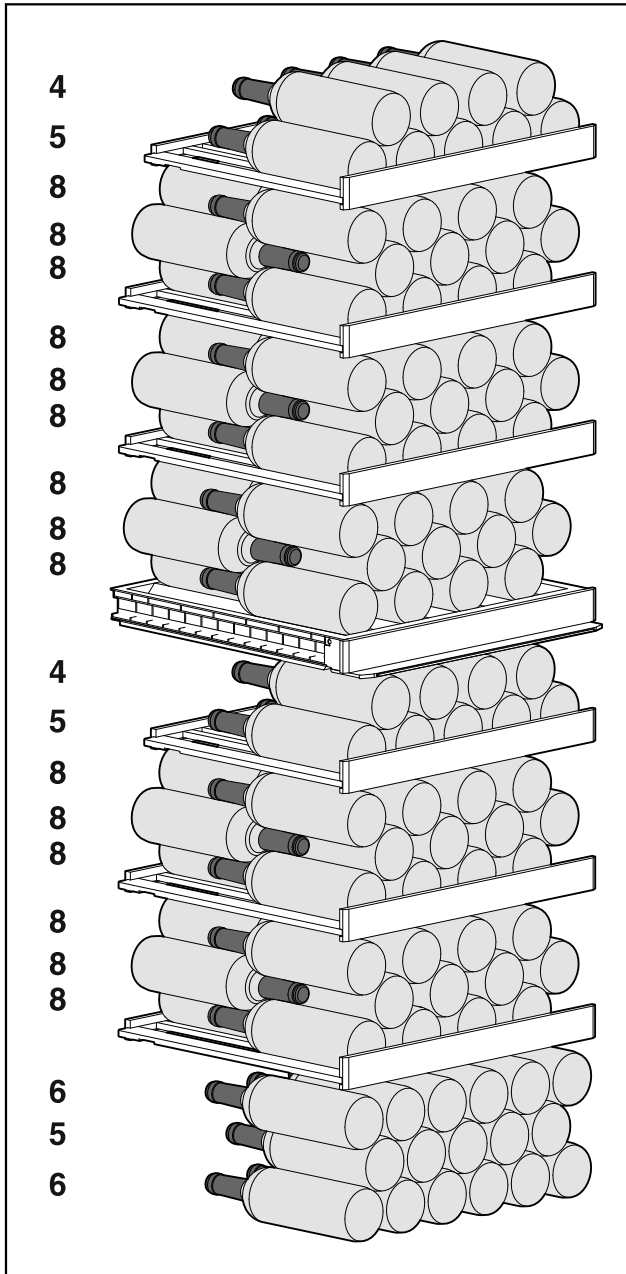

Fig. 9 155 bottles in total (for 0.75 l Bordeaux bottles)

### 5.2.2 WP.. 7483 / Wgb7470

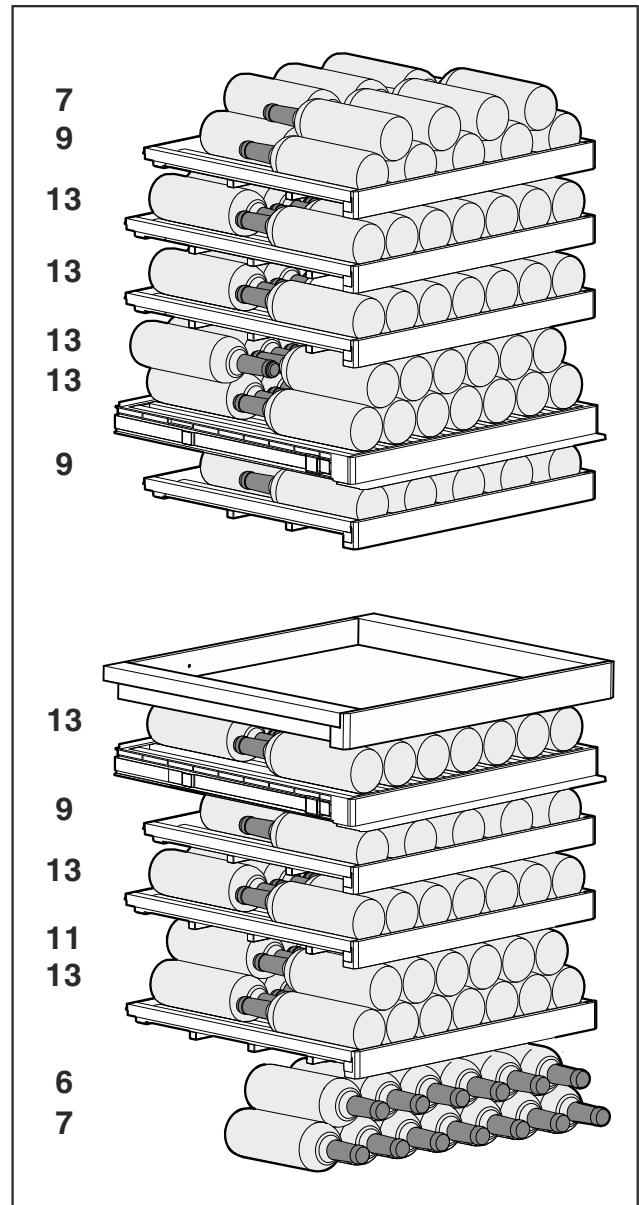

Fig. 10 149 bottles in total (for 0.75 l Bordeaux bottles)

## 6 Energy saving

- Always ensure good ventilation. Keep clear of obstruction all ventilation openings in the appliance enclosure or in the structure for building-in.
- Never block air slits in the fan.
- Do not set up the appliance in an area with direct sunlight, next to a heating unit or similar.
- If you set up the appliance directly next to an oven, its energy consumption may increase slightly. This depends on the service life and how often the oven is used.
- Energy consumption depends on installation conditions such as the ambient temperature

(see 1.4 Range of appliance use) . A warmer ambient temperature can increase the energy consumption.

- Avoid opening the appliance door for any longer then necessary
- The lower the temperature is set the higher the energy consumption.

## 7 Use

### 7.1 Control and display elements

The display provides a quick overview of the current appliance status, the temperature setting, the status of functions and settings as well as alarm and error messages.

They are operated directly on the Touch & Swipe display by swiping and tapping.

Functions can be activated or deactivated and settings values can be changed.



Fig. 11 Touch & Swipe display\*

(1) Status display

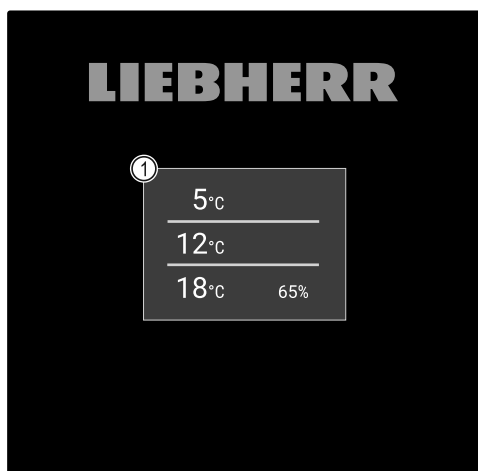

Fig. 12 Touch & Swipe display\*

(1) Status display

### 7.1.1 Status display

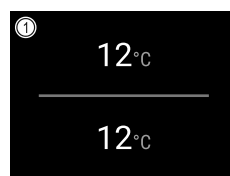

Fig. 13 Status display\*

(1) Temperature

The status display is the initial display.

You can navigate from the functions and settings from the status display.

### 7.1.2 Display symbols

The display symbols provide information about the current status of the appliance.

Symbol	Appliance status
	<b>Standby symbol</b> Appliance is switched off.
	<b>Standby (flashing) symbol</b> Appliance is starting up.
	<b>Temperature (flashing)</b> Target temperature not yet reached. Appliance cooling to set temperature.
	<b>Status display (white border)</b> Appliance is locked.
	<b>D in the display</b> Appliance is in demo mode.
	<b>Manual door opening (yellow)</b> The locked door was opened manually.
	<b>Error symbol (red)</b> Appliance is in error state.
	<b>Background (blue)</b> Active setting or active function
	<b>Bar (increasing)</b> Press for 3 seconds to activate setting.

# Use

Symbol	Appliance status
	<b>Bar (decreasing)</b> Press for 3 seconds to deactivate setting.

Status display symbols

## 7.1.3 Acoustic signals

A signal sounds in the following cases:

- If a function or a value is confirmed.
- If a function or a value can neither be activated nor deactivated.
- As soon as a fault occurs.
- If there is an alarm message.

The alarms can be switched on and off in the customer menu.

## 7.2 Appliance functions

### 7.2.1 Notes on the appliance functions

The appliance functions are set at the factory so that your appliance is fully functional.

Before you alter, activate or deactivate the appliance functions, make sure that the following requirements are met:

- You have read and understood the descriptions of how the display works. (see 3 Functionality of the Touch & Swipe display)
- You have familiarized yourself with the operating and display elements of your appliance. (see 7.1 Control and display elements)

### 7.2.2 Switching appliance on and off



This function makes it possible to switch the entire appliance on and off.

#### Switching on appliance

Without activated demo mode:

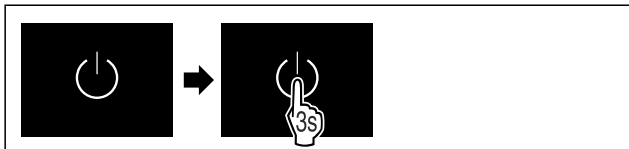

Fig. 14

► Carry out action steps according to the illustration.

With activated demo mode:

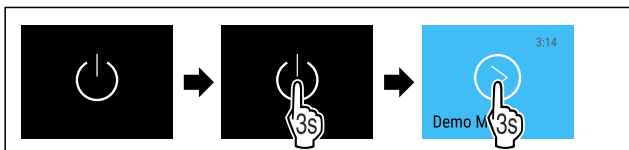

Fig. 15

► Carry out action steps according to the illustration.

#### Note

Deactivate demo mode before the countdown ends.

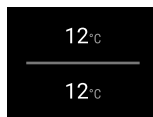

Fig. 17 Status display

► The temperature appears in the display.

### Switching off appliance



Fig. 18

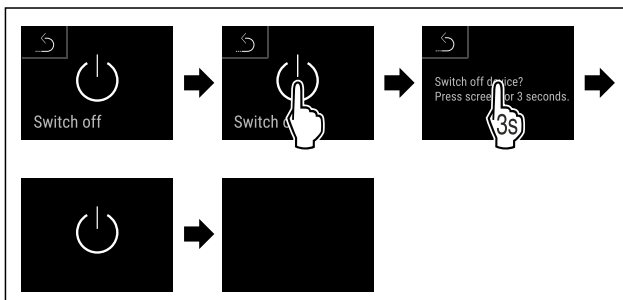

Fig. 19

► Carry out action steps according to the illustration.

► Standby symbol is shown in the display.

► Display switches off after about 10 minutes.

### 7.2.3 WiFi



Use this function to connect your appliance to WiFi. You can then operate it via the SmartDevice app on a mobile device. You can also use this function to disconnect or reset the WiFi connection.

More information on the SmartDevice: (see 1.3 SmartDevice)

#### Note

The SmartDevice function is not available in the following countries: Russia, Belarus, Kazakhstan.

#### Establishing the WiFi connection for the first time

Make sure that the following requirements are fulfilled:

- You have installed the SmartDevice app (see [apps.home.liebherr.com](https://apps.home.liebherr.com)).
- Registration in the SmartDevice app is completed.

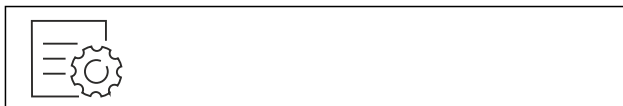

Fig. 20

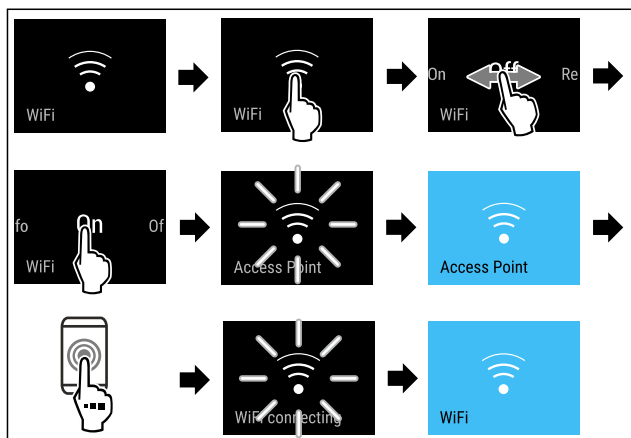

Fig. 21

- ▶ Carry out action steps according to the illustration.
- ▷ Connection is established.

### Disconnecting from the WiFi



Fig. 22

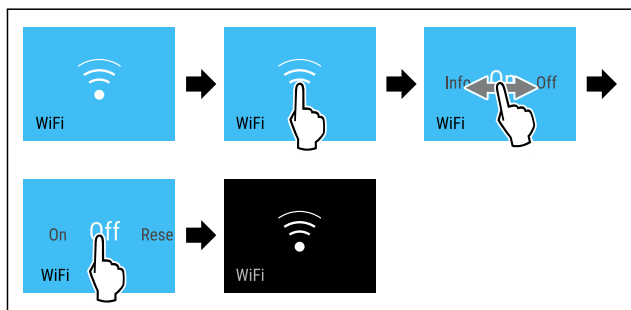

Fig. 23

- ▶ Carry out action steps according to the illustration.
- ▷ There is no connection.

### Resetting the WiFi connection



Fig. 24

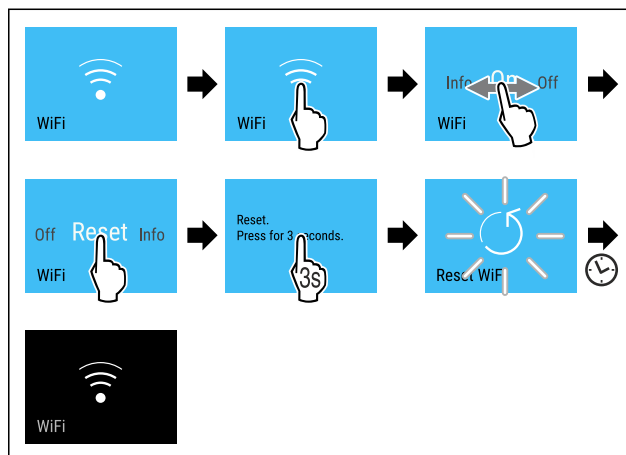

Fig. 25

- ▶ Carry out action steps according to the illustration.
- ▷ WiFi connection and other WiFi settings are reset to factory settings.

### Showing information about the WiFi connection



Fig. 26

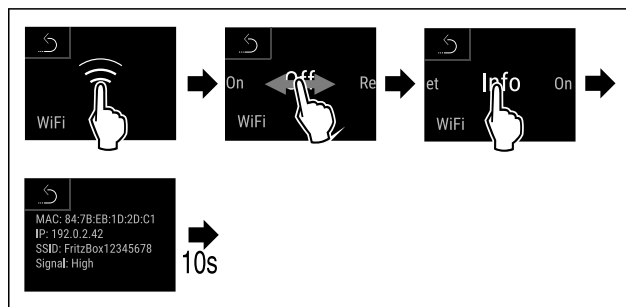

Fig. 27

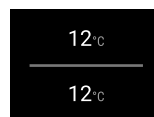

Fig. 28 Status display

- ▶ Carry out action steps according to the illustration.

## 7.2.4 Temperature



The temperature depends on the following factors:

- How often the door is opened
- How long the door is open for
- The room temperature of the installation site
- The type, temperature and amount of refrigerated items

# Use

## Note

The temperature may differ from the temperature displayed in some areas of the interior.

At the correct temperature, refrigerated items will keep for longer. This avoids disposing of food unnecessarily.

## Setting the temperature

The following steps describe how to increase the temperature, for example, from 5 °C (41 °F) to 10 °C (50 °F).

▶ Tap the temperature of the desired zone.

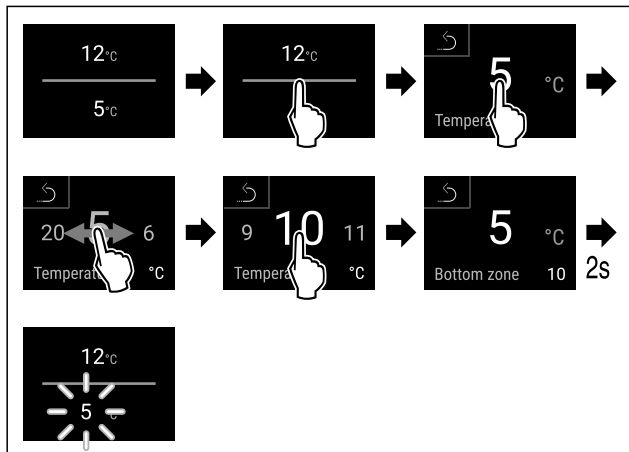

Fig. 29 \*

- ▶ Carry out action steps according to the illustration.
- ▷ Temperature is set.



## 7.2.5 Temperature unit

Use this function to set the temperature unit. You can set the temperature unit in either degrees Celsius or degrees Fahrenheit.

### Setting the temperature unit

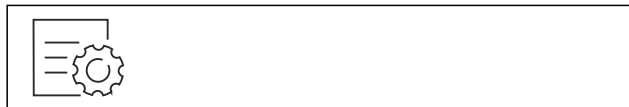

Fig. 30

- ▶ Carry out action steps according to the illustration.
- ▷ Temperature unit is set.



## 7.2.6 SabbathMode

This function activates and deactivates SabbathMode. If you activate this function, some electronic functions are switched off. Your appliance thereby meets the religious requirements of Jewish holidays such as the Sabbath and complies with STAR-K Kosher certification.

### Appliance status with active SabbathMode

The status display continuously shows SabbathMode.
All functions in the display except the <b>Deactivating SabbathMode function</b> are disabled.
Active functions remain active.
The display remains bright when you close the door.
The interior lighting is deactivated.
Memories are not listed. The set time interval is stopped.
Memories and warnings are not displayed.
There is no door alarm.
There is no temperature alarm.
After a power failure, the device returns to SabbathMode.

### Appliance status

## Note

This appliance has certification from the “Institute for Science and Halacha”. ([www.machonhalacha.co.il](http://www.machonhalacha.co.il))

You can find a list of STAR-K-certified appliances at [www.star-k.org/appliances](http://www.star-k.org/appliances).

## Activating SabbathMode



Fig. 32



Fig. 33

- ▶ Carry out action steps according to the illustration.
- ▷ SabbathMode is activated.
- ▷ Status display continuously shows SabbathMode.

## Deactivating SabbathMode

SabbathMode is automatically deactivated after 80 hours. However, you can also manually deactivate SabbathMode at any time:



Fig. 34

- ▶ Carry out action steps according to the illustration.
- ▷ SabbathMode is deactivated.
- ▷ Doors locks automatically.

## 7.2.7 HumiditySelect

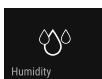

Use this function to set the humidity inside your appliance. Setting the humidity correctly will have a positive effect on the structure of the corks during long-term storage and prevent them from drying out.

### Note

The frequency and duration for which the door is open influence the humidity in the appliance.

You can choose between two humidity settings:

Humidity-Select function	Temperature setting on the appliance	Application/energy consumption
Standard (preset)	10 (50)-12 °C (54 °F)	average humidity in the environment between 50-80% low energy consumption of the appliance
High	10 (50)-12 °C (54 °F)	average humidity in the environment < 50% energy consumption of the appliance increases

### Increasing humidity in the appliance



Fig. 35

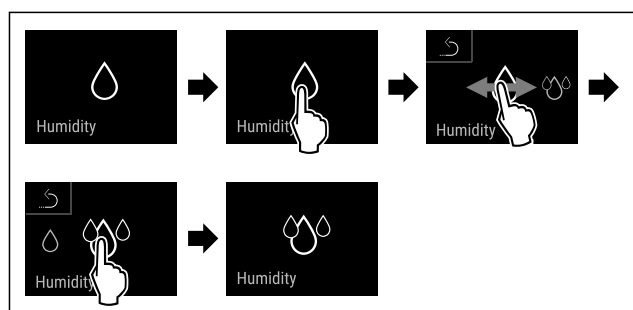

Fig. 36

- ▶ Carry out action steps according to the illustration.
- ▷ Humidity in the appliance increases.

### Setting humidity in the appliance to standard



Fig. 37

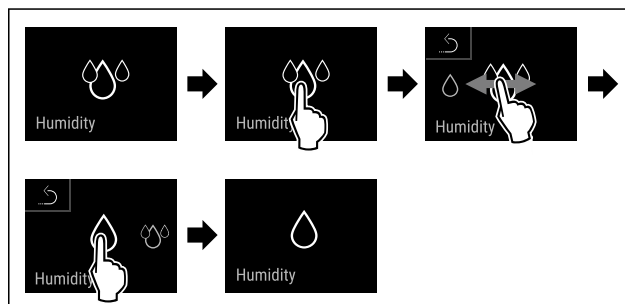

Fig. 38

- ▶ Carry out action steps according to the illustration.
- ▷ Humidity in the appliance decreases.

## 7.2.8 Presentation light



This setting allows the presentation light to be adjusted incrementally.

The following brightness values can be set:

- Off
- 20%
- 40%
- 60%
- 80%
- 100% (default)

### Adjusting the presentation light

The following steps describe how to reduce the brightness of the presentation light, for example, from 100 % (100 %) to 40 % (40 %).



Fig. 39

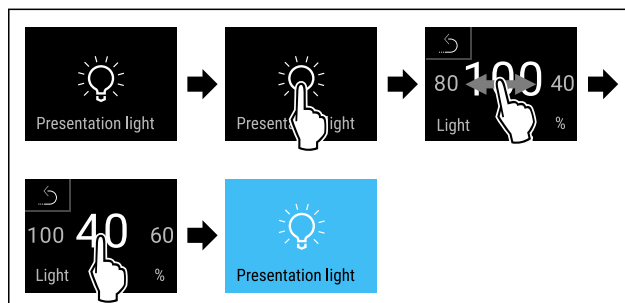

Fig. 40

## Use

- ▶ Carry out action steps according to the illustration.
- ▷ The brightness of the presentation light changes accordingly.

### 7.2.9 Display Brightness



Use this function to set the brightness of the display gradually.

You can set the following brightness levels:

- 20%
- 40 %
- 60 %
- 80 %
- 100% (default setting)

#### Setting the brightness



Fig. 41

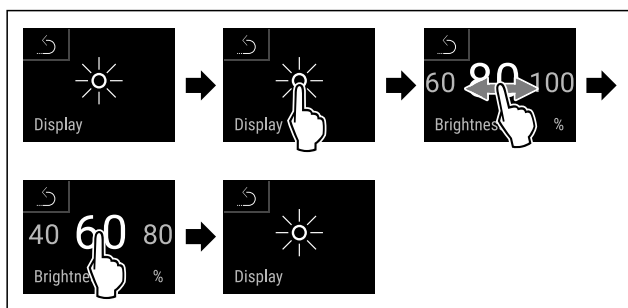

Fig. 42 Example illustration: Switching from 80% to 60%.

- ▶ Carry out action steps according to the illustration.
- ▷ Brightness is set.

### 7.2.10 Door alarm



Use this function to activate or deactivate the door alarm. The door alarm sounds if the door is open for too long. The door alarm is activated upon delivery. You can set how long to door can remain open until the door alarm sounds.

You can set the following values:

- 1 minute
- 2 minutes
- 3 minutes
- Off

#### Setting the door alarm



Fig. 43

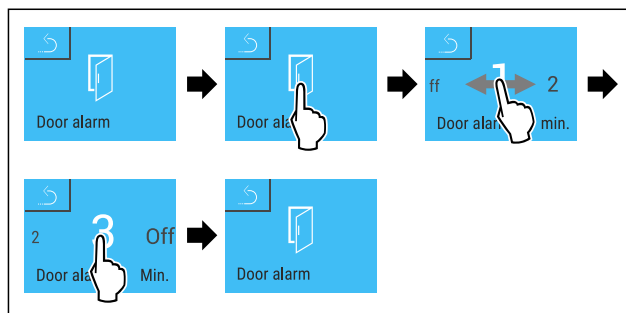

Fig. 44 Example illustration: Changing the door alarm from 1 minute to 3 minutes.

- ▶ Carry out action steps according to the illustration.
- ▷ Door alarm is set.

#### Deactivating door alarm



Fig. 46

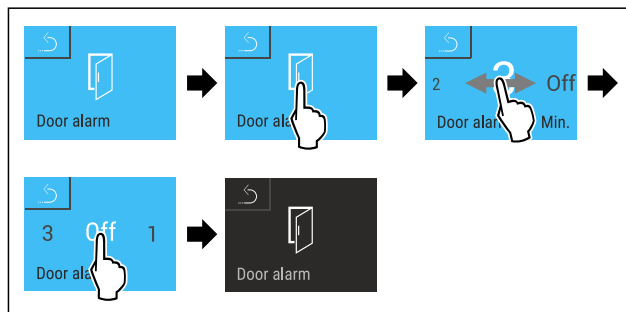

Fig. 47

- ▶ Carry out action steps according to the illustration.
- ▷ Door alarm is deactivated.

### 7.2.11 Alarm Sound



This function enables all alarm sounds, such as the door alarm, to be switched on and off.

#### Activating Alarm Sound



Fig. 48



Fig. 49

- ▶ Carry out action steps according to the illustration.
- ▷ Alarm Sound is activated.

## Deactivating Alarm Sound



Fig. 50

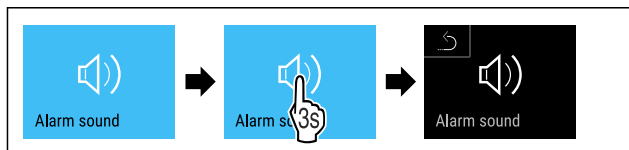

Fig. 51

- ▶ Carry out action steps according to the illustration.
- ▷ Alarm Sound is deactivated.



## 7.2.12 Display lock

This setting avoids accidental use of the appliance.

Application:

- Prevent settings and functions being changed unintentionally.
- Prevent the appliance from being switched off unintentionally.
- Prevent the temperature from being adjusted unintentionally.

### Note

Despite the display lock being activated, the door lock can be opened and locked at any time using the PIN code (see 7.2.13 Access codes).

## Activating display lock



Fig. 52

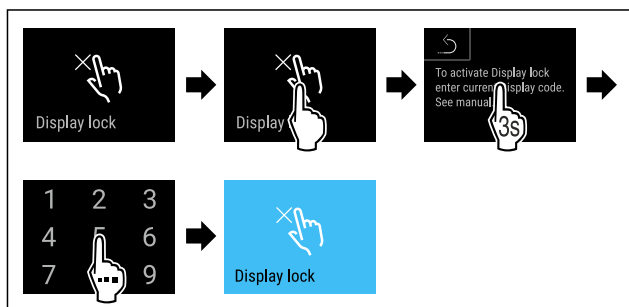

Fig. 53

- ▶ Carry out action steps according to the illustration.
- ▷ The display lock is activated.
- ▷ The status display appears.

## Temporarily unlocking the display lock

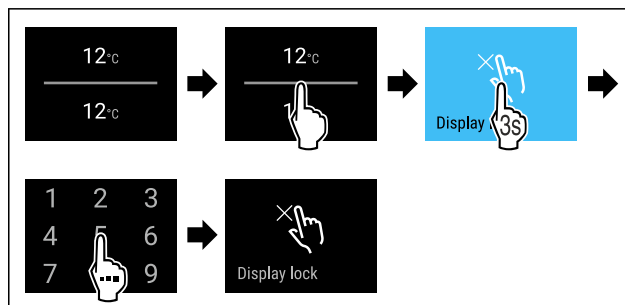

Fig. 54 \*

- ▶ Carry out action steps according to the illustration.
- ▷ The display lock is deactivated.
- ▷ The status display appears.

## 7.2.13 Access codes

Various settings are possible.

Application:

- Changing the door code.
- Resetting the door code.
- Changing the display lock code.
- Resetting the display lock code.

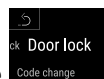

## Door code

Code change

### Changing the door code

This setting allows the door code for the door lock to be changed.

The setting is made in 3 stages:

- Entering the old door code
- Entering the new door code
- Confirming the new door code

### Note

- ▶ In the following example, the default factory-set door code **1 1 1 1** is changed.
- ▶ The new door code is **2 3 4 5**

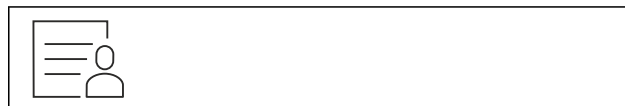

Fig. 55

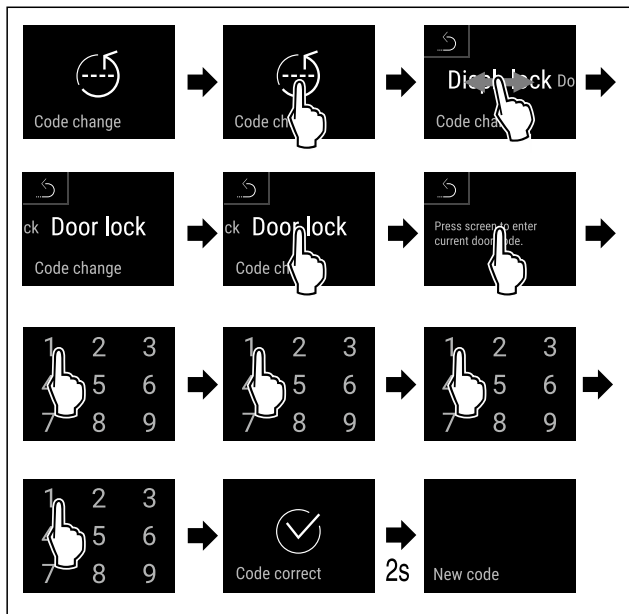

Fig. 56

- ▶ Carry out action steps according to the illustration.
- ▷ Entry of the old door code successful.

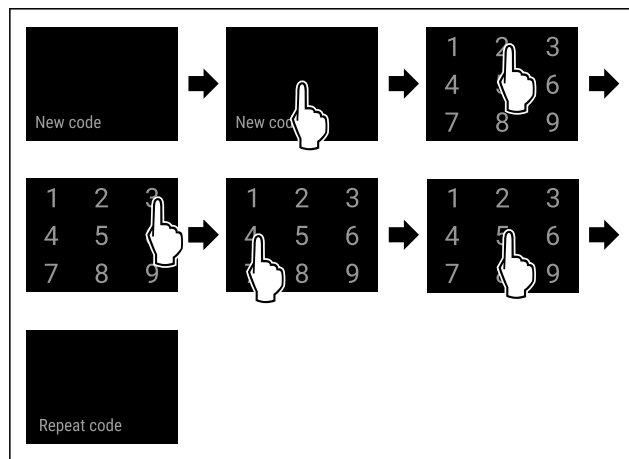

Fig. 57

- ▶ Carry out action steps according to the illustration.
- ▷ Entry of the new door code successful.

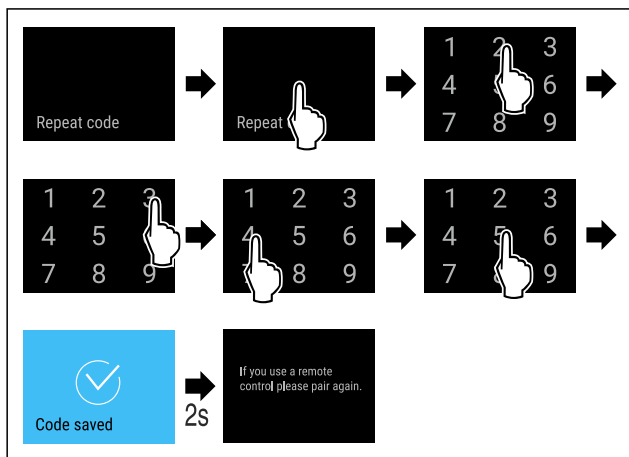

Fig. 58

- ▶ Carry out action steps according to the illustration.
- ▷ Confirmation of the new door code successful.
- ▷ The door code has been changed.
- ▶ Re-pair the remote control.

**Resetting door code**

- The door code has been forgotten or is not known.
- ▶ Reset the appliance to factory settings. (see 7.2.19 Resetting to factory settings )
  - ▷ The appliance is reset to the original settings.
  - ▷ The factory setting for the door code is: **1 1 1 1**



**Display lock**

**Changing display lock code**

This setting allows the code for the display lock to be changed.

The setting is made in 3 stages:

- Entering of old code
- Entering of new code
- Confirming of new code

**Note**

- ▶ In the following example, the default factory-set code **1 1 1 1** is changed.
- ▶ The new code is: **2 3 4 5**

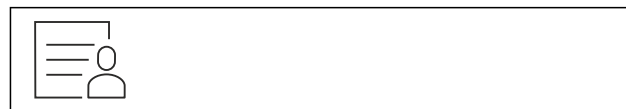

Fig. 59

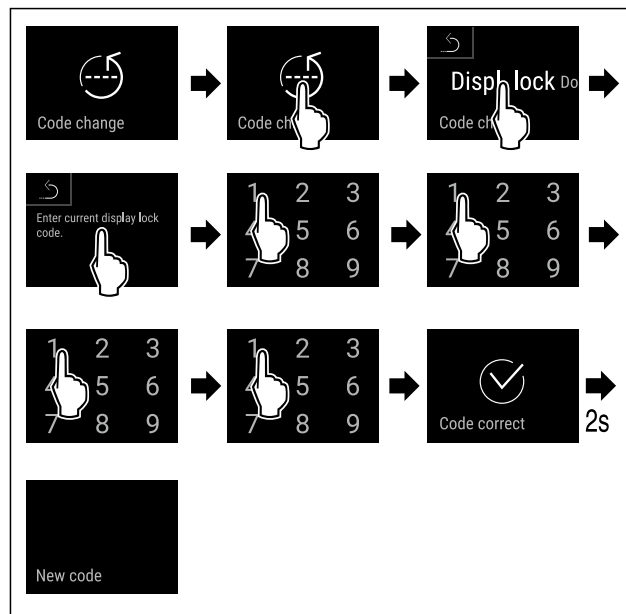

Fig. 60

- ▶ Carry out action steps according to the illustration.
- ▷ Entry of the old code successful.

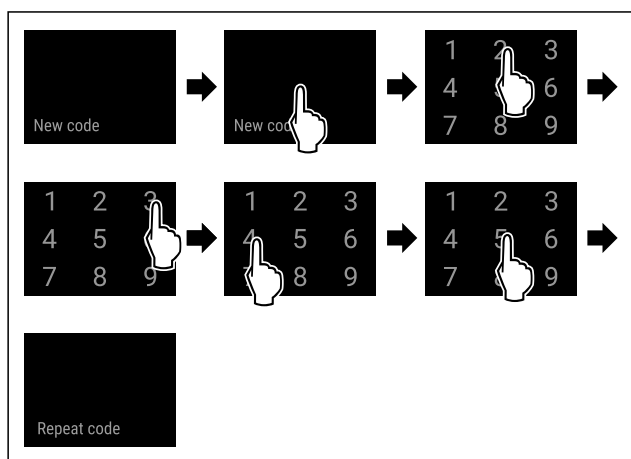

Fig. 61

- ▶ Carry out action steps according to the illustration.
- ▷ Entry of the new code successful.

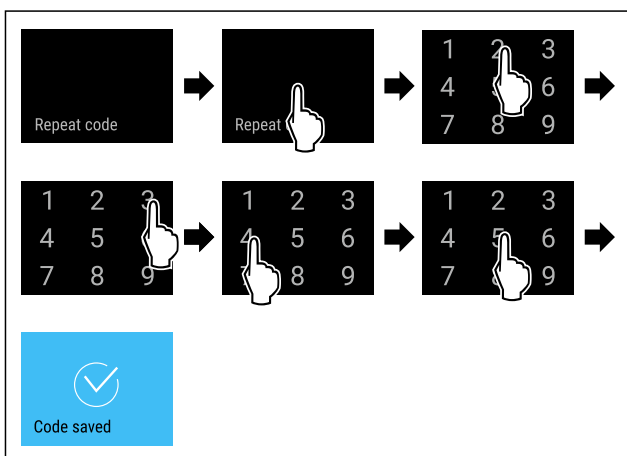

Fig. 62

- ▶ Carry out action steps according to the illustration.
- ▷ Confirmation of the new code successful.
- ▷ The code has been changed.

### Resetting display lock code

Code forgotten or not known.

- ▶ Reset the appliance to factory settings. (see 7.2.19 Resetting to factory settings )
- ▷ The appliance is reset to the original settings.
- ▷ The factory-set code is: **1 1 1 1**

### 7.2.14 Language



This setting allows the display language to be set.

#### Setting the language



Fig. 63

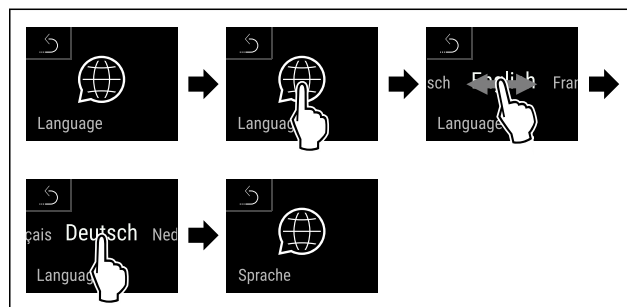

Fig. 64

- ▶ Carry out action steps according to the illustration.
- ▷ The selected language is set.

### 7.2.15 Appliance information



Use this function to display the model name, index, serial number and service number of your appliance. You will need the appliance information when you contact customer service. (see 10.4 Customer Service) You also use this function to open the expanded menu. (see 3 Functionality of the Touch & Swipe display)

#### Display appliance information



Fig. 65

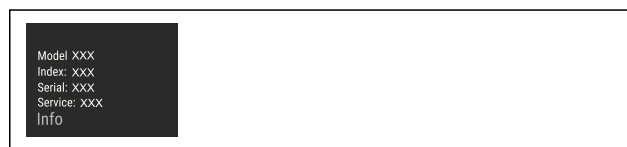

Fig. 66

- ▶ Carry out action steps according to the illustration.
- ▷ Display shows the appliance information.

### 7.2.16 Software



Use this function to display the software version of your appliance.

#### Display software version



Fig. 67

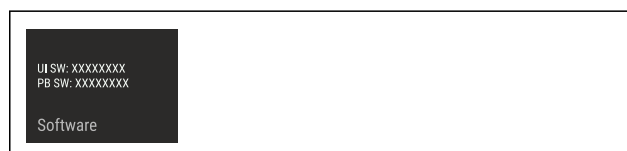

Fig. 68

# Use

- ▶ Carry out action steps according to the illustration.
- ▷ Display indicates the software version.



## 7.2.17 Reminder

This function allows you to activate or deactivate the reminder to change the FreshAir activated charcoal filter.

### Deactivating the reminder



Fig. 69

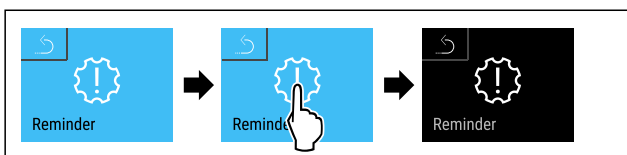

Fig. 70

- ▶ Carry out steps according to the illustration.
- ▷ Reminder is deactivated.

### Activating the reminder

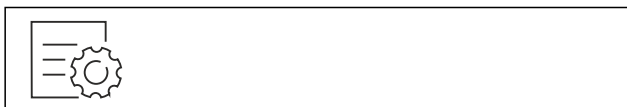

Fig. 71

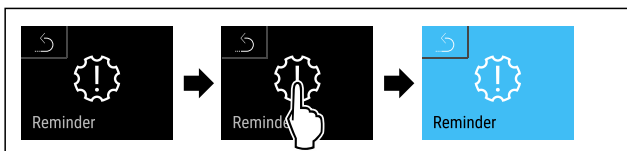
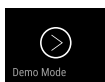

Fig. 72

- ▶ Carry out steps according to the illustration.
- ▷ Reminder is activated.



## 7.2.18 Demo mode

Demo mode is a special feature for dealers who want to demonstrate appliance features. If you activate demo mode, all refrigeration functions are deactivated.

If you switch on your appliance and a “D” appears on the status display, demo mode is already activated.

If you activate and then deactivate demo mode, the appliance will be reset to factory defaults. (see 7.2.19 Resetting to factory settings )

### Activating demo mode

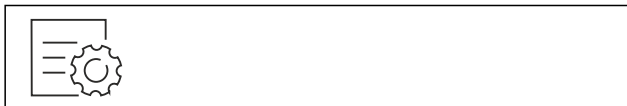

Fig. 73

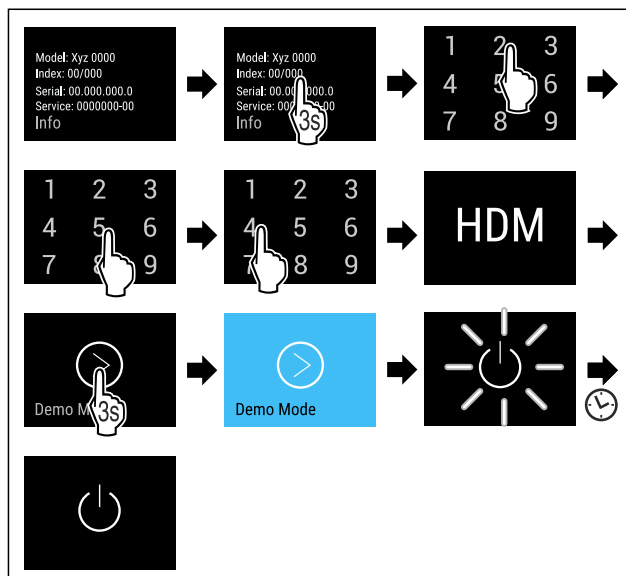

Fig. 74

- ▶ Carry out action steps according to the illustration.
- ▷ Demo mode is activated.
- ▷ Appliance is switched off.
- ▶ Switch on the appliance. (see 4.1 Switching on the appliance (first use))
- ▷ “D” appears in the status display.

### Deactivating demo mode



Fig. 75

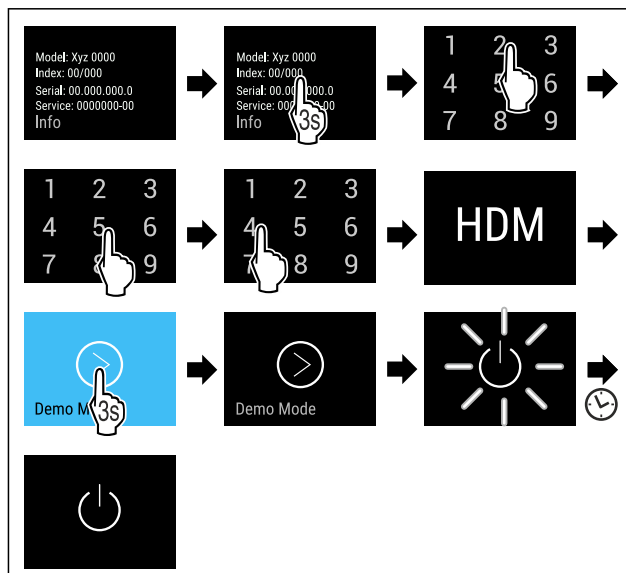

Fig. 76

- ▶ Carry out action steps according to the illustration.
- ▷ Demo mode is deactivated.
- ▷ Appliance is switched off.
- ▶ Switch on the appliance. (see 4.1 Switching on the appliance (first use))
- ▷ Appliance is reset to factory settings.

## 7.2.19 Resetting to factory settings



Use this function to reset all settings to factory settings. All settings you have made so far are reset to their original settings.

### Performing a reset



Fig. 77

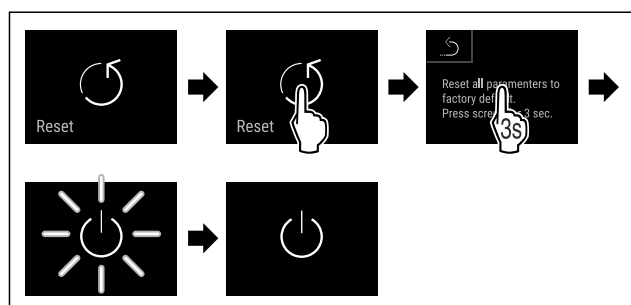

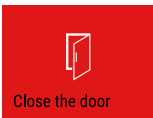

Fig. 78

- ▶ Carry out action steps according to the illustration.
- ▷ Appliance is reset.
- ▷ Appliance is switched off.
- ▶ Restart the appliance. (see 4.1 Switching on the appliance (first use))



## 7.3 Messages

### 7.3.1 Warnings

Warnings are issued by means of an audio signal and visually via a symbol on the display. The signal gets louder until the warning is acknowledged.

Message (red)	Cause	Remedy
 <p><b>Door open</b></p>	<p>The message appears if the door is open for too long.</p>	<p>Close the door.</p> <p>Tap briefly.</p> <p>Alarm is stopped.</p> <p><b>Note</b></p> <p>The time until the message appears can be set. (see 7.2.10 Door alarm )</p>
 <p><b>Temperature alarm</b></p>	<p>This message appears if the temperature does not match the set temperature. Reasons for differences in temperature can be:</p> <p>Warm produce for cooling has been placed inside.</p> <p>Too much warm room air has flowed in during the rearrangement and removal of food.</p> <p>The power was cut off for a prolonged period.</p>	<p>Tap briefly.</p> <p>Information about errors and appliance status are displayed.</p> <p>Tap briefly.</p> <p>Warmest/coldest temperature, date and time are displayed.</p> <p>Tap briefly.</p> <p>The status screen is displayed.</p> <p>The current temperature and the alarm symbol flash red until the set temperature is reached.</p> <p>Check the quality of the refrigerated goods.</p>

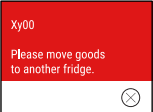
# Use

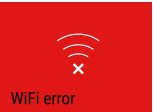
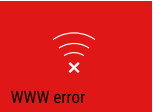
Message (red)	Cause	Remedy
 <p>Device failure</p> <p><b>Error</b></p>	<p>The appliance is malfunctioning, there is an appliance error or a component of the appliance has a fault.</p>	<p>Store refrigerated items elsewhere.</p> <p>Tap briefly.</p> <p>The error code (e.g. BT021) is displayed.</p> <p>Tap briefly.</p> <p>A further error code is displayed if there is one</p> <p><b>or</b></p> <p>Status screen is displayed with flashing error symbol.</p> <p>Swiping or tapping the display will show the error code(s) again.</p> <p>Make a note of error code(s) and contact Customer Service. (see 10.4 Customer Service)</p>  
 <p>Power failure</p> <p><b>Power failure</b></p>	<p>The message appears following an interruption to the electricity supply.</p>	<p>Tap briefly.</p> <p>Battery's state of charge, information about errors and appliance status are displayed</p> <p>Tap briefly.</p> <p>The warmest temperature and the time when there was a power outage are displayed.</p> <p>Tap briefly.</p> <p>The status screen is displayed.</p> <p>The current temperature and the alarm symbol flash red until the set temperature is reached.</p> <p>Check the quality of the refrigerated goods.</p>
 <p>WiFi error</p> <p><b>WiFi error</b></p>	<p>WiFi connection is interrupted.</p>	<p>Check connection.</p> <p>Press briefly.</p> <p>Alarm is stopped.</p>
 <p>WWW error</p> <p><b>WWW error, WiFi</b></p>	<p>This message appears if there is no internet connection via WiFi.</p>	<p>Check connection.</p> <p>Press briefly.</p> <p>Alarm is stopped.</p>

## 7.3.2 Reminders

Reminders appear when you are prompted to take action. They are issued by means of an audio signal and visually via a symbol on the display. Acknowledge the message by pressing the confirmation button.

Message (yellow)	Cause	Remedy
 <p>Manually opened</p> <p><b>Manually opened</b></p>	<p>This message appears if a door which has been locked electronically is manually opened.</p>	<p>Close the door.</p> <p>Press briefly.</p> <p>Enter the door code to close it again.</p> <p>Reminder is closed.</p>

Message (yellow)	Cause	Remedy
 <p><b>Replace FreshAir activated charcoal filter</b></p>	The message appears every 6 months.	Replace FreshAir activated charcoal filter. Press briefly. Reminder is closed.

## 8 Equipment

### 8.1 Safety lock

The appliance is fitted with an electronic lock.

Possible functions:

- Locking and unlocking the door lock using the door code.
- Operation via remote control.

#### 8.1.1 Emergency unlocking

You can open the door can with the emergency release key if there is a power failure.

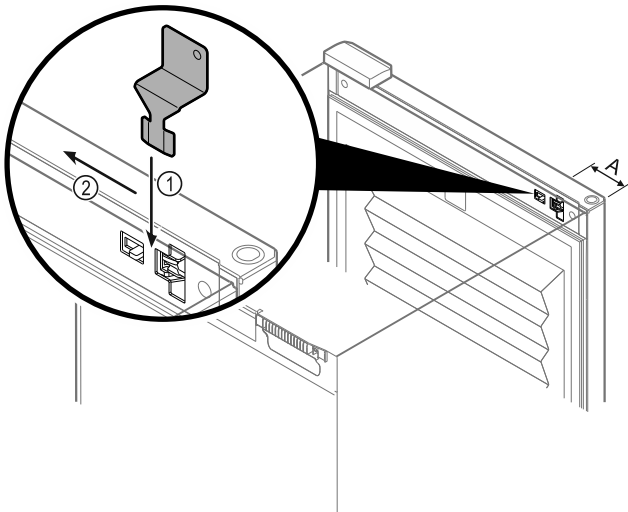

Fig. 79

- ▶ Insert the emergency release key in the specified position Fig. 79 (A) ≈ 100 mm (3 15/16 in).
- ▶ Insert the emergency release key Fig. 79 (1) from the top between the door and device body until it reaches the stop.
- ▶ Pull the emergency release key in the direction of the hinge. Fig. 79 (2)
- ▷ The lock is released. You can open the door.

### 8.2 Description labels

Description labels as accessories can be purchased from your specialist dealer. You can use these to note the types of wine that are stored in the respective compartment.

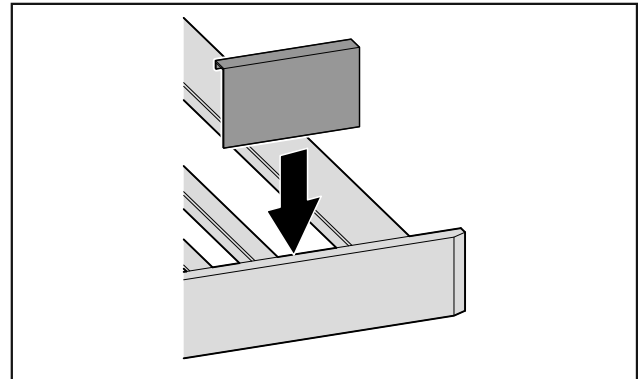

Fig. 80

- ▶ Attach the description label from above.

### 8.3 Water box

You can increase the humidity in your wine appliance by using the water box.

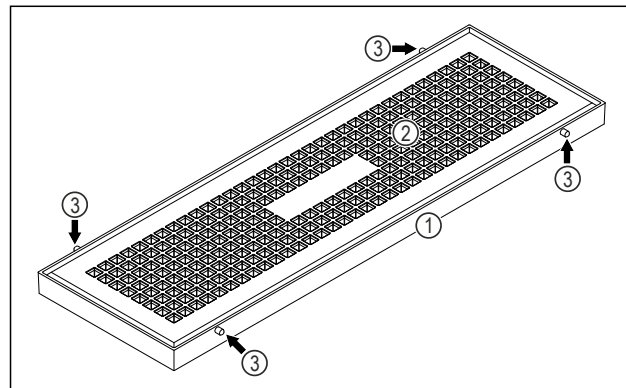

Fig. 81 Example illustration of the water box

- (1) Water tray
- (2) Cover
- (3) Peg

#### 8.3.1 Filling the water box with water

Make sure that the following requirements are fulfilled:

- Water box is removed. (see 8.3.3 Removing the water box)
- Water box is horizontal.

# Maintenance

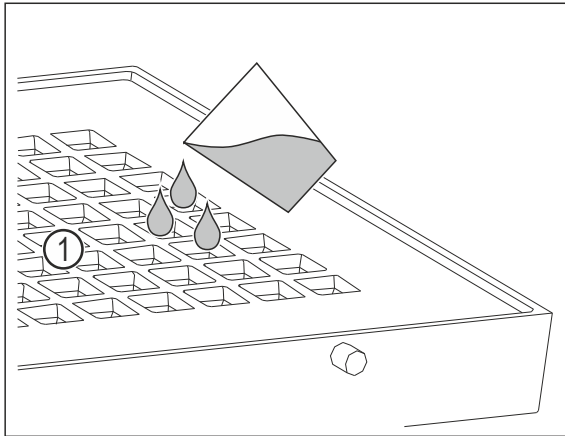

Fig. 82

- ▶ Fill in water no more than 400 ml (13.53 oz) over the holes Fig. 82 (1) in the cover.

## 8.3.2 Inserting the water box

You can insert the water box on a wooden grating in the bottom wine zone.

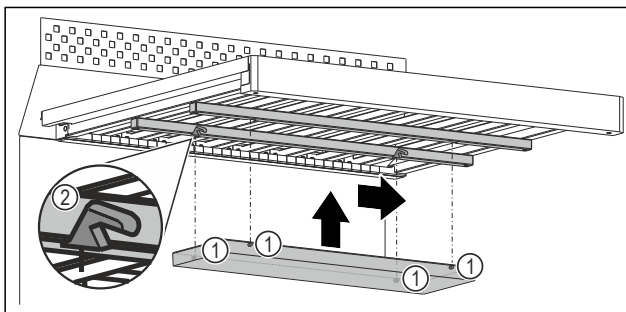

Fig. 83 Example illustration

- ▶ Insert each peg Fig. 83 (1) in the corresponding recess Fig. 83 (2) on the battens below the wooden grating.
- ▶ Slide the water box to the right.
- ▶ Check to make sure that the water box is horizontal and the pegs are in the corresponding recess.

## 8.3.3 Removing the water box

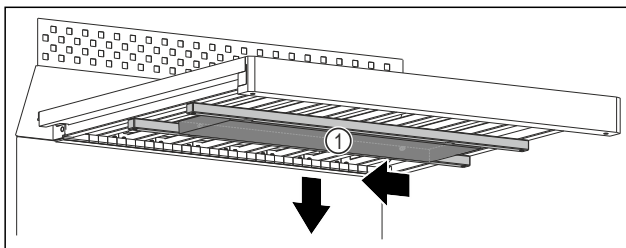

Fig. 84

- ▶ Slide the water box Fig. 84 (1) to the left.
- ▶ Remove the water box Fig. 84 (1) downward.

## 8.3.4 Disassembling the water box

You can disassemble the water box for cleaning.

Make sure that the following requirements are fulfilled:

- Water box is removed. (see 8.3.3 Removing the water box)
- Water box is completely empty.

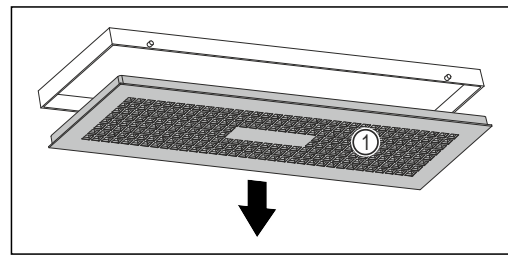

Fig. 85

- ▶ Slowly turn the water box downward and keep a firm hold on the cover Fig. 85 (1) while doing so.
- ▶ Remove the cover Fig. 85 (1).

# 9 Maintenance

## 9.1 Air exchange through the FreshAir activated charcoal filter

Wine is constantly developing according to its ambient conditions, so air quality is essential for preservation.

The FreshAir activated charcoal filter guarantees optimal air quality.

- Change the activated charcoal filter every 6 months.
- Dispose of the activated charcoal filter with regular household waste.

### Note

FreshAir activated charcoal filters can be purchased from the Liebherr Service Center. The address for your respective country can be found on the back of the instructions.

### 9.1.1 Replacing the FreshAir activated charcoal filter

Must be carried out multiple times depending on the equipment.

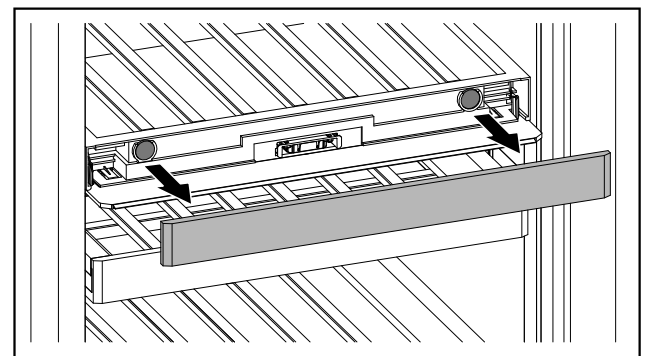

Fig. 86

- ▶ Remove the panel.

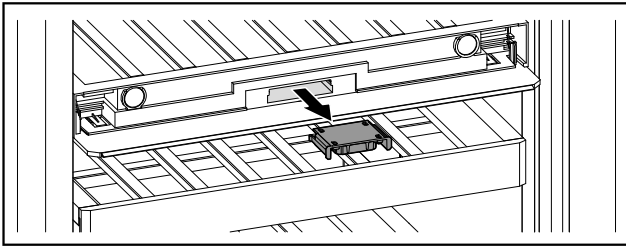

Fig. 87

- ▶ Pull the drawer out.

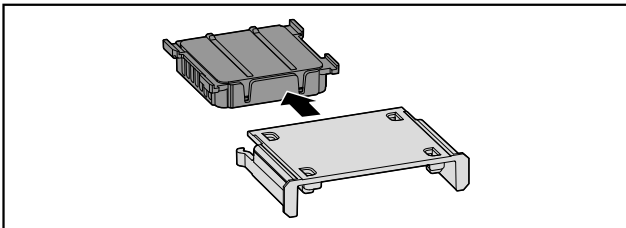

Fig. 88

- ▶ Pull out the filter.

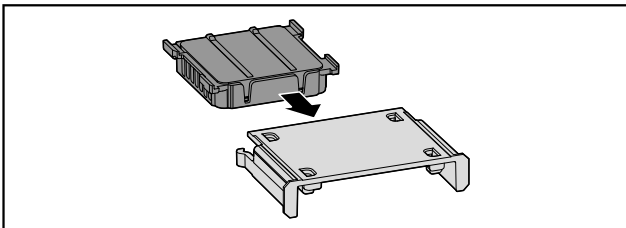

Fig. 89

- ▶ Insert the new filter.

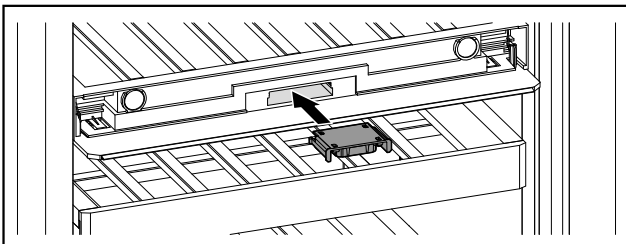

Fig. 90

- ▶ Push the drawer in.

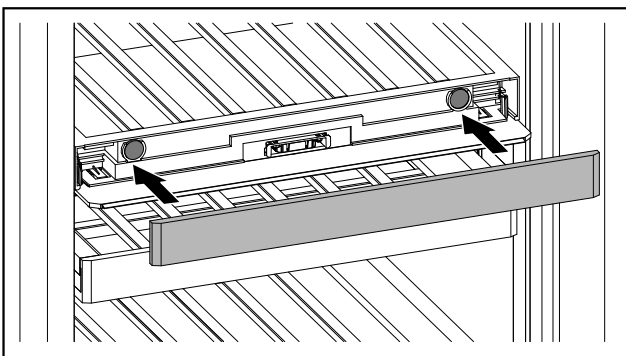

Fig. 91

- ▶ Set the panel back in place.

## 9.2 Cleaning the appliance

### 9.2.1 Preparation



#### WARNING

Danger of electric shock.

- ▶ Unplug refrigerator or disconnect power.



#### WARNING

Danger of fire

- ▶ Do not damage the refrigerant circuit.

- ▶ Empty appliance.
- ▶ Pull out the power plug.

### 9.2.2 Cleaning the housing

#### NOTICE

Improper cleaning!

Damage to the appliance.

- ▶ Only use soft cleaning cloths and ph-neutral all-purpose cleaners.
- ▶ Do not use steel wool or sponges that scour or scratch.
- ▶ Do not use caustic or abrasive cleaning materials or those containing sand, chloride, or acids.



#### WARNING

Risk of injury or damage due to hot steam.

Hot steam can cause scalding/burns and damage to surfaces.

- ▶ Do not use steam cleaners.

- ▶ Wipe the housing down with soft, clean cloth. If very dirty, use lukewarm water with a neutral cleaner. Glass surfaces can also be cleaned with glass cleaner.

### 9.2.3 Cleaning the interior

#### NOTICE

Improper cleaning!

Damage to the appliance.

- ▶ Only use soft cleaning cloths and ph-neutral all-purpose cleaners.
- ▶ Do not use steel wool or sponges that scour or scratch.
- ▶ Do not use caustic or abrasive cleaning materials or those containing sand, chloride, or acids.
- ▶ Plastic surfaces: clean by hand with a soft clean cloth, lukewarm water and a little detergent.
- ▶ Metal surfaces: clean by hand with a soft clean cloth, lukewarm water and a little detergent.

# Customer support

## 9.2.4 Cleaning the equipment

### NOTICE

Improper cleaning!  
Damage to the appliance.

- ▶ Only use soft cleaning cloths and ph-neutral all-purpose cleaners.
- ▶ Do not use steel wool or sponges that scour or scratch.
- ▶ Do not use caustic or abrasive cleaning materials or those containing sand, chloride, or acids.

### Clean with a damp, lint-free cloth:

- Bottle shelf
- ▶ Clean the equipment.

## 9.2.5 After cleaning

- ▶ Wipe dry the appliance and items of equipment
- ▶ Connect and switch on the appliance.
- ▶ Repeat cleaning regularly.

# 10 Customer support

## 10.1 Technical specifications

Maximum load weight of equipment		
Equipment	Appliance width 600 mm (23 1/2 in) (see installation instructions, appliance dimensions)	Appliance width 750 mm (29 7/16 in) (see installation instructions, appliance dimensions)
Bottle shelf	60 kg (132 lb)	60 kg (132 lb)

For appliances with a WiFi connection:

Frequency specification	
Frequency band	2.4 GHz
Maximum radiated power	< 100 mW
Purpose of the wireless equipment	Integration in the local WiFi network for data communication

## 10.2 Operating noises

The appliance makes noises while in operation.

- At **less cooling output** the appliance saves energy but takes longer to cool items. The volume is **lower**.
- At **a higher cooling output** the food cools more quickly. The volume is **higher**.

Examples:

- Activated functions (see 7.2 Appliance functions)
- Running fan
- Freshly sorted food
- High ambient temperature
- Door opened for long periods

Noise	Possible cause	Type of noise
Bubbling and splashing	Coolant is flowing into the cooling circuit.	Normal noise
Spitting and hissing	Coolant is spraying into the cooling circuit.	Normal noise
Humming	The appliance cools. The volume depends on the cooling output.	Normal noise
Sipping noises	The self-closing door is being opened and closed.	Normal noise
Whirring and murmuring	The fan is running.	Normal operating noise
Clicking	Components are being switched on and off.	Normal switching noise
Rattling or humming	Valves are active.	Normal switching noise

Noise	Possible cause	Type of noise	How to resolve
Vibration	Unsuitable setup	Error noise	Adjust the feet to make sure the appliance is horizontal.
Clattering	Equipment, Objects inside the appliance	Error noise	Secure equipment parts. Leave a gap between items.

## 10.3 Technical faults

Your appliance is designed and manufactured for reliable operation and a long service life. If a malfunction nonetheless occurs during operation, please check whether the malfunction is due to an operating error. In

this case, you will have to be charged for the costs incurred, even during the warranty period.

You may be able to rectify the following faults yourself.

### 10.3.1 Appliance function

Defect	Cause	Remedy
<b>The appliance does not work.</b>	The appliance is not switched on.	▶ Switch on the appliance.
	The power plug is not properly inserted in the wall socket.	▶ Check the power plug.
	The powerfuse in the wall socket is not OK.	▶ Check the fuse.
	Power failure.	▶ Keep the appliance closed.
	The IEC socket is not correctly plugged into the appliance.	▶ Check the IEC socket.
<b>The temperature is not cold enough</b>	This means that the door of the appliance is not closed properly	▶ Close the appliance door
	The ambient temperature is too high	▶ Problem solution: (see 1.4 Range of appliance use)
	The appliance was opened too frequently or for too long	▶ Wait to see if the required temperature corrects itself. If not, contact Customer Service. (see 10.4 Customer Service)
	The temperature is incorrectly set	▶ Set to a colder temperature and check after 24 hours.
	The appliance is too near to a heat source (stove, heater etc).	▶ Change location of appliance or the heat source.
<b>The door seal is defective or should be replaced for other reasons.</b>	The door seal is interchangeable. You can replace it without the use of any special tools.	▶ Contact Customer Service. (see 10.4 Customer Service)
<b>The appliance is iced up or condensation is building.</b>	The door seal may have slipped out of its groove.	▶ Check the door seal is well placed in the groove.
<b>The outside surfaces of the appliance are hot*.</b>	The heat of the refrigerant circuit is used to prevent condensate from forming	▶ This is normal.

### 10.3.2 Equipment

Defect	Cause	Remedy
<b>Mold on wine bottles</b>	As encountered with other forms of storage, a little mold may form	▶ Remove adhesive residues

# Decommissioning

Defect	Cause	Remedy
	depending on the type of label adhesive	
<b>The interior light does not turn on.</b>	The appliance is not switched on.	▶ Switch on the appliance.
	The door was open for more than 15 minutes.	▶ If the door is open, the interior lighting switches off automatically after about 15 minutes.
	The LED interior light is faulty or the lid is damaged.	▶ Contact Customer Service. (see 10.4 Customer Service)

## 10.4 Customer Service

First check whether you can rectify the fault yourself (see 10 Customer support) . If you cannot rectify the problem, contact Customer Service.

You can find the address in the enclosed brochure "Liebherr-Service" or at [home.liebherr.com/service](http://home.liebherr.com/service).



### WARNING

Unprofessional repair!  
Injuries.

- ▶ A damaged power cable may only be replaced by the manufacturer, the manufacturer's Customer Service or a similarly qualified person.
- ▶ For appliances with plug and play connection cables, the change can be made by the customer.

### 10.4.1 Contacting Customer Service

Make sure that the following appliance information is available:

- Appliance name (model and index)
- Service no. (service)
- Serial no. (S no.)

▶ Call up the appliance information via the display.

-or-

- ▶ Refer to the type plate for appliance information. (see 10.5 Rating plate)
- ▶ Take note of the appliance information.
- ▶ Notify customer service: Report errors and the appliance information.
- ▷ This will help us give you fast and accurate support.
- ▶ Follow further instructions from Customer Service.

## 10.5 Rating plate

The type plate is located on the bottom left of the inside of the appliance.

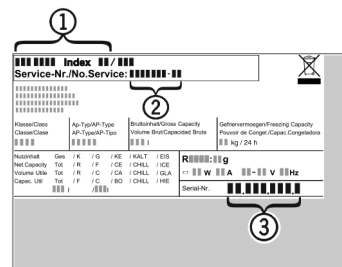

Fig. 92

- (1) Appliance name
  - (2) Service no.
  - (3) Serial no.
- ▶ Information from the nameplate.

## 11 Decommissioning

- ▶ Empty appliance.
- ▶ Switch off appliance. (see 7.2.2 Switching appliance on and off )
- ▶ Pull the power plug from the outlet.
- ▶ If necessary, remove the IEC socket: Pull the IEC socket out of the appliance plug while turning it to the left and right at the same time.
- ▶ Clean appliance. (see 9.2 Cleaning the appliance)
- ▶ Leave the door open to prevent unpleasant odors.

## 12 Disposal

### 12.1 Preparing the appliance for disposal



### WARNING

Risk of child entrapment!

- Before you throw away your old refrigerator or freezer:
- ▶ Take off the doors.
  - ▶ Leave the shelves in place so that children may not easily climb inside.



**Li-Ion**

Liebherr uses batteries in some of its appliances. You should remove these before disposal of the old appliance for environmental reasons. If your appliance contains batteries, a corresponding notice is attached to the appliance.

**Lamps** If you can remove the lamps yourself without destroying them, also remove these before disposal.

- ▶ Take the appliance out of operation.
- ▶ If possible: Remove lamps without destroying them.

## 12.2 Disposing of the appliance in an environmentally friendly manner



The appliance still contains valuable materials and must be collected separately from unsorted municipal waste so it can be recycled.



**Li-Ion**



**Li-Ion**

Dispose of batteries separately from the old appliance. Certain batteries should NOT go in household garbage or recycling bins. Waste batteries can always be recycled or taken to household hazardous waste collection points. To prevent fires from lithium-ion batteries, tape battery terminals and/or place batteries in separate plastic bags and never put these batteries in household garbage or recycling bins.

**Lamps** Dispose of removed lamps via the respective collection systems.

**For USA:** Check the Responsible Appliance Disposal (RAD) program to find a RAD partner near you.

**For Canada:** Follow your local guidance about recycling and disposal capabilities near you.



### WARNING

Leaking refrigerant and oil!  
Fire. The refrigerant contained within the appliance is environmentally friendly, but flammable. The oil contained within the appliance is flammable. Escaping refrigerant and oil can ignite if they are of high enough concentration and are exposed to an external heat source.

- ▶ Do not damage the pipelines of the coolant circuit and the compressor.
- ▶ Observe the notes on appliance transport.
- ▶ Transport the appliance away without damaging it.
- ▶ Dispose of batteries, lamps, and the appliance according to the above specifications.



[home.liebherr.com/fridge-manuals](https://home.liebherr.com/fridge-manuals)

**EN** Multi-temperature wine cabinet

Issue date: 20250204

**Part number index: 7083586-00**

For Service in the U.S.: Liebherr Service Center  
Toll Free: 1-866-LIEBHER or 1-866-543-2437  
Service-appliances.us@liebherr.com  
PlusOne Solutions, Inc.  
3501 Quadrangle Blvd, Suite 120  
Orlando, FL 32817

For Service in Canada: Liebherr Service Center  
Toll Free: 1-888-LIEBHER or 1-888-543-2437  
www.euro-parts.ca  
EURO-PARTS CANADA  
39822 Belgrave Road, Belgrave, Ontario, N0G 1E0  
Phone: (519) 357-3320 | Fax: (519) 357-1326