



User Guide

Quality, Design and Innovation



home.liebherr.com/fridge-manuals









LIEBHERR

The appliance at a glance

reserve the right to make changes to the shape, equipment and technology.

- User Guide
- Installation Guide
- Warranty documents

Symbol	Explanation
	Read instructions Please read the information in these instructions carefully to understand all of the benefits of your new appliance.
	Additional information online The digital manual with supplemental information can be found online by scanning the QR code on the front page of this manual or by entering the service number at home.liebherr.com/fridge-manuals .
	Check appliance Check all parts for transport damage. If you have any complaints, please contact your agent or customer service.
	Differences These instructions apply to a range of models, so there may be differences. Sections that apply to certain models only are indicated by an asterisk (*).
	Instructions and results Instructions are marked with a ▶. Results are marked with a ▷.
	Videos Videos about the appliances are available on the YouTube channel of Liebherr-Hausgeräte.

Open-source licenses:

The appliance includes software components that make use of open-source licenses. You can find information on the open-source licenses to be used here: home.liebherr.com/open-source-licenses

These operating instructions apply to:

URP	3653
URD	3753

1 The appliance at a glance

1.1 Delivered contents

Check all parts for transport damage. If you have any complaints, please contact the retailer or customer service. (see 10.4 Customer Service)

Delivery contains the following parts:

- Integrated appliance
- Equipment (depending on your model)
- Installation parts (depending on your model)

1.2 Overview of appliances and equipment

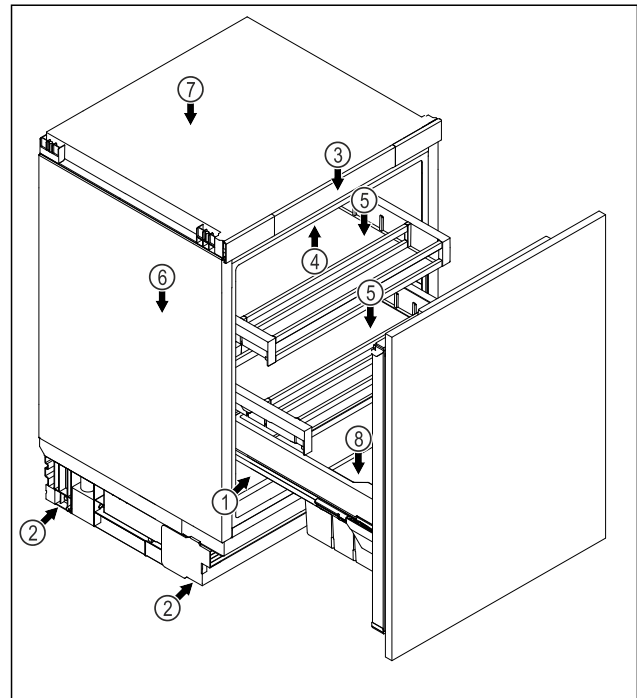

Fig. 1 Exemplary illustration of the front side

Equipment

- | | |
|--|---|
| (1) Type plate | (5) Drawer |
| (2) Adjustable feet | (6) Defrost water drain |
| (3) Operating elements and temperature display | (7) Fan with FreshAir activated charcoal filter |
| (4) Interior lighting | (8) Pull-out cart with beverage drawer |

Note

▶ The shelves, drawers, and baskets are arranged for optimal energy efficiency in the factory configuration. However, changes to the arrangement within the given insertion options – for example the arrangement of shelves in the fridge compartment – have no effect on energy consumption.

1.3 SmartDevice

SmartDevice is the networking solution for your refrigerator.

If your appliance is SmartDevice-enabled or compatible, you can quickly and easily connect your appliance to your WiFi. With the SmartDevice app, you can operate your appliance from a mobile device. Additional functions and setting options are available in the SmartDevice app.

General safety instructions

SmartDevice-enabled appliance:

Your appliance is capable of being a SmartDevice. To be able to connect your device to WiFi, you need to download the SmartDevice app.



More information about SmartDevice: smartdevice.liebherr.com

Downloading the SmartDevice app:



After installing and configuring the SmartDevice app, you can connect your appliance to the WiFi using the SmartDevice app and the WiFi appliance function (see WiFi).

1.4 Range of appliance use

Normal use

This appliance is intended to be used in household and similar applications such as,

- staff kitchen areas in shops, offices and other working environments;
- farm houses and by clients in hotels, motels and other residential type environments;
- bed and breakfast type environments;
- catering and similar non-retail applications.

The appliance is not suitable for freezing food; The appliance is suitable for integrated under worktop use

All other types of uses are not permitted.

Foreseeable misuse

The following uses are specifically prohibited:

- Storage and cooling of medication, blood plasma, laboratory preparations or similar substances and products in accordance with the CMDCAS and FDA 510(k)
- Use outdoors
- Use in moist areas exposed to the rain
- Use in areas at risk of explosion

Incorrect appliance use can cause damage to the stored products or cause them to spoil.

Climate ratings

The appliance is set to operate within specific ambient temperature limits according to its climate rating. The climate rating for your appliance is printed on the rating plate

Note

► To guarantee trouble-free operation, comply with the indicated ambient temperatures.

Climate rating	for ambient temperatures from
SN	10 °C (50 °F) to 32 °C (90 °F)
N	16 °C (61 °F) to 32 °C (90 °F)
ST	16 °C (61 °F) to 38 °C (100 °F)
T	16 °C (61 °F) to 43 °C (109 °F)
SN-ST	10 °C (50 °F) to 38 °C (100 °F)
SN-T	10 °C (50 °F) to 43 °C (109 °F)

1.5 Conformity

The refrigerant circuit has been tested for leaks. When installed, the appliance complies with the applicable safety regulations and with the corresponding directives.

1.6 Spare parts

Spare parts for functional and storable parts of the equipment are available for 15 years.

2 General safety instructions

Please keep these operating instructions in a safe place so you can refer back to them at any time.

If you pass the appliance on, please hand these operating instructions to the new owner.

Read and follow these instructions. They contain safety information which is important for safe and problem-free installation and operation. Always read and follow the safety information.

Dangers for the user:

- This appliance is not intended for use by persons (including children) with reduced physical, sensory or mental capabilities, or lack of experience and knowledge, unless they have been given supervision or instruction concerning use of the appliance by a person responsible for their safety. Children should be supervised to ensure that they do

General safety instructions

not play with the appliance. Cleaning and user maintenance must not be performed by children unless they are supervised. Children between the ages of 3 and 8 may load and unload the appliance. Children under the age of 3 must be kept away from the appliance unless they are constantly supervised.

- **IMPORTANT:** The power plug must be easily accessible so that the appliance can be disconnected from the mains quickly in an emergency. It must not be behind the back of the appliance.
- The socket must be easily accessible so that the appliance can be disconnected quickly from the electricity in an emergency. It must not be located in the area behind the appliance.
- Always hold the appliance at the plug when disconnecting it from the household power. Do not pull on the cable.
- Disconnect the power plug or fuse if there is a malfunction.
- Do not damage the power cable. Do not operate the appliance with a faulty power cable. If the supply cord is damaged, it must be replaced by the manufacturer, its service agent or similarly qualified persons in order to avoid a hazard. For Plug and Play connections, the change may be carried out by the customer.
- Repairs and work on the appliance may only be carried out by Customer Service or other specifically trained qualified personnel.
- Only install, connect and dispose of the appliance in accordance with the instructions.
- Only operate the appliance after it has been installed.

Risk of fire:

- The refrigerant contained within the appliance (specifications on the identification plate) is environmentally friendly, but flammable. Leaking refrigerant can ignite.
 - **WARNING:** Do not damage the refrigerant circuit.
 - Do not handle ignition sources inside the appliance.
 - **WARNING:** Do not use electrical appliances inside the food storage compartments of the appliance, unless they are of

the type recommended by the manufacturer (e.g. steam cleaning appliances, heating appliances, ice cream makers).

- If refrigerant leaks: Remove naked flames or ignition sources located near the area of the leak. Ventilate the room well. Contact Customer Service.
- Do not operate the appliance near explosive gases.
- Do not store or use gasoline or other flammable gases and liquids near the appliance.
- Do not store explosive substances such as aerosol cans with a flammable propellant in this appliance. You can recognize such spray cans by the printed list of contents or by a flame symbol. Any leaking gases can be ignited by electrical components.
- Alcoholic beverages or other containers holding alcohol must always be tightly sealed for storage purposes. Any leaking alcohol can be ignited by electrical components.

Risk of falling or toppling over:

- **WARNING:** To avoid a hazard due to instability of the appliance, it must be fixed in accordance with the instructions.
- Do not stand on the base, drawers, doors etc. or use them as improper supports. This applies in particular to children.

Danger of poisoning:

- Do not consume spoiled food.

Danger of frostbite, feeling of numbness and pain:

- Avoid prolonged skin contact with cold surfaces or chilled/frozen food or take protective measures, e.g. wear gloves.

Risk of injury and damage:

- Hot steam may cause injuries. Do not use any electrical heating or steam cleaning equipment, naked flames or defrosting sprays for defrosting measures.
- **WARNING:** Do not use mechanical devices or other means to accelerate the defrosting process, other than those recommended by the manufacturer.
- Do not remove ice using sharp objects.

General safety instructions

- **WARNING:** Keep clear of obstruction all ventilation openings in the appliance enclosure or in the structure for building-in.
- **WARNING:** Risk of child entrapment. Before you throw away your old refrigerator or freezer:
 - Take off the doors.
 - Leave the shelves in place so that children may not easily climb inside.

Risk of crushing:

- Do not hold onto the hinge when opening and closing the door. Fingers may become trapped.

California Proposition 65

- **WARNING:** This product can expose you to chemicals including Diisononyl Phthalate (DINP), which is known to the State of California to cause cancer, and Diisodecyl Phthalate (DIDP), which is known to the State of California to cause birth defects or other reproductive harm. For more information, go to www.P65Warnings.ca.gov

FCC Warning

- Changes or modifications not expressly approved by the party responsible for compliance could void the user's authority to operate the equipment.

FCC information

- This appliance has been tested and found to comply with the limits for a Class B digital device, pursuant to part 15 of the FCC Rules. These limits are designed to provide reasonable protection against harmful interference from an installation in residential areas. This appliance generates, uses and can radiate radio-frequency energy and, if not installed and used in accordance with the instructions, may cause harmful interference to radio communications. However, there is no guarantee that interference will not occur in a particular installation. If this appliance does cause harmful interference to radio or television reception, which can be determined by switching the appliance on and off, the user should try to correct the interference by one or more of the following measures:
 - Reorient or relocate the receiving antenna.

- Increase the distance between the appliance and receiver.
- Connect the appliance to an outlet on a circuit different from that to which the receiver is connected.
- Consult the dealer or an experienced radio/TV technician for help.

FCC Radio Frequency Exposure Statement

- This appliance is found to comply with FCC radio frequency (RF) exposure limits set for an uncontrolled environment. This transmitter must not be set up or operated in conjunction with another antenna or another transmitter.
- This appliance should be installed and operated with a minimum space of 200 mm (7 7/8 in) between the antenna and your body. The user must follow the specific operating instructions to ensure compliance with RF exposure.

IC information

- This appliance has license-exempt transmitters/receivers, which comply with the license-exempt Radio Standards Specification (RSS) of Innovation, Science and Economic Development Canada. Operation is subject to the following two conditions:
 - This appliance may not cause interference.
 - This device must accept any interference, including interference that may cause undesired operation of the device.

IC Radio Frequency Exposure Statement

- This appliance meets the IC RSS-102 limits for radiation exposure, which were defined for an uncontrolled environment. This appliance should be installed and operated so that there is a minimum space of 200 mm (7 7/8 in) between the antenna and your body.

Symbols on the device:



The symbol may be located on the compressor. It refers to the oil in the compressor and refers to the following danger: Can be fatal if swallowed or inhaled. This notice only applies for recycling. There is no danger during normal operation.

Functionality of the Touch & Swipe display



WARNING: Risk of fire / flammable materials. The symbol is located on the compressor and indicates the danger from flammable materials. Do not remove the label.



This label or a similar one may be located on the rear of the appliance. This label indicates that there are vacuum insulation panels (VIP) or perlite panels in the door and/or housing. This notice only applies for recycling. Do not remove the label.

Observe the warning messages and other detailed information in the other sections:

	DANGER	Indicates an immediately hazardous situation, which if not avoided, will result in death or serious injury.
	WARNING	Indicates a hazardous situation, which if not avoided, could result in death or serious injury.
	CAUTION	Indicates a hazardous situation, which if not avoided, could result in minor or moderate injury.
	NOTICE	Indicates a hazardous situation, which if not avoided, could result in damage to property.
	Note	Indicates useful advice and tips.

3 Functionality of the Touch & Swipe display

You operate your appliance using the Touch & Swipe display. You select appliance functions in the Touch & Swipe display (hereafter referred to as display) by tapping them. If you do not perform any action on the display for 10 seconds, the display either jumps back to the higher-level menu or directly to the status display.

3.1 Navigation and symbol explanation

In the illustrations, different symbols are used to navigate the display. The following table describes these symbols.

Symbol	Description
	Briefly touch the display: Activates/deactivates function. Confirms selection. Opens submenu.
	Touch the display for a specified time (e.g. 3 seconds): Activates/deactivates function or value.
	Swipe left or right: Navigate in the menu.
	Briefly touch the Back symbol: Jumps back one menu level.
	Press and hold the Back symbol for 3 seconds: Jumps back to the status display.
	Arrow with clock: It takes more than 10 seconds for the following message to appear in the display.
	Arrow with a time indication: It takes the specified amount of time until the following message appears in the display.
	“Open Settings menu” symbol: Navigates to the Settings menu and opens the settings menu. If necessary: Navigate to the desired function in the Settings menu. (see 3.2.1 Opening the Settings menu)
	“Open Advanced menu” symbol: Navigates to the Advanced menu and opens the advanced menu. If necessary: Navigate to the desired function in the Advanced menu. (see 3.2.2 Opening expanded menu)
No action for 10 seconds	If you do not perform any action on the display for 10 seconds, the display either jumps back to the higher-level menu or directly to the status display.

Start-up

Symbol	Description
Open door and close it again.	If you open the door and immediately close it again, the display jumps directly back to the status display.

Note: Illustrations of the display are shown in the English version.

3.2 Menus

The appliance functions are distributed over various menus:

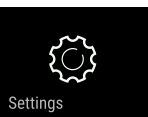
Menu	Description
Main menu	When you switch the appliance on, you are automatically in the main menu. From here you can navigate to the most important appliance functions, to the Settings menu and to the Advanced menu.
 Settings menu	The Settings menu contains additional appliance functions for setting up your appliance.
Advanced menu	The advanced menu contains special appliance functions for setting up your appliance. Access to the Advanced menu is protected by the numerical code 151 .

3.2.1 Opening the Settings menu

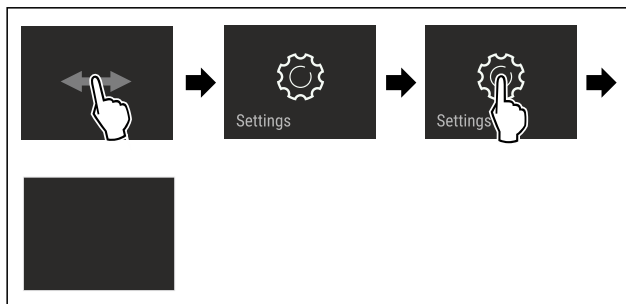

Fig. 2 Example illustration

- ▶ Carry out action steps according to the illustration.
- ▷ Settings menu is open.
- ▶ If necessary: Navigate to the desired function.

3.2.2 Opening expanded menu



Fig. 3

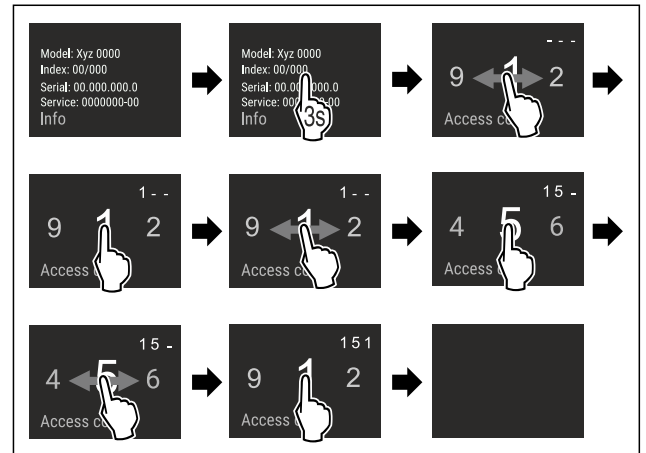

Fig. 4 Example illustration, access with numerical code **151**

- ▶ Carry out action steps according to the illustration.
- ▷ Expanded menu is open.
- ▶ If necessary: Navigate to the desired function.

3.3 Sleep mode

If you do not touch the display for 1 minute, the display switches to sleep mode. In sleep mode, the display brightness is dimmed.

3.3.1 Ending sleep mode

- ▶ Touch the display briefly with your finger.
- ▷ Sleep mode is ended.

4 Start-up

4.1 Switching on appliance (first use)

Make sure that the following requirements are fulfilled:

- The appliance is properly installed and connected according to the installation instructions.
- All adhesive strips, adhesive and protective films and transport locks are removed from inside and on the appliance.
- All marketing leaflets are removed from the drawers.
- You are familiar with the functionality of the Touch & Swipe display. (see 3 Functionality of the Touch & Swipe display)

Switch on the appliance using the Touch & Swipe display.

- ▶ If the display is in sleep mode: Briefly touch the display.
- ▶ Carry out action steps according to the illustration.

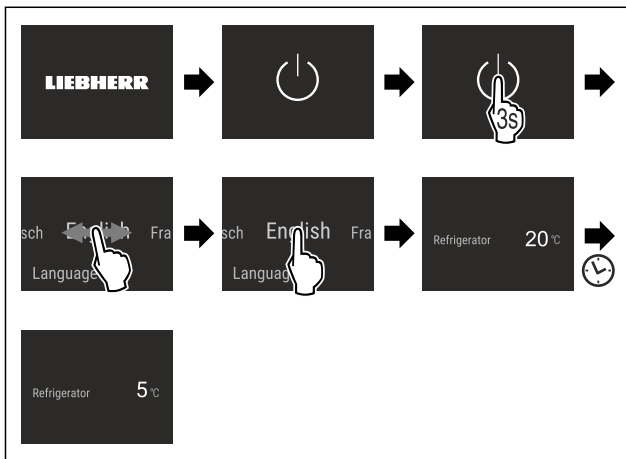

Fig. 5 Example illustration

- ▷ Status display appears.
- ▷ The appliance cools to the temperature set at the factory.
- ▷ The appliance starts in demo mode (status display with DEMO appears): If the appliance starts in demo mode, you can deactivate demo mode within the next 5 minutes. (see Demo mode)

More information:

- Start the SmartDevice for the first time. (see 1.3 SmartDevice) and (see WiFi)

Note

The manufacturer recommends:

- ▶ Stock with food: Wait for around 6 hours until the set temperature is reached.
- ▶ Observe the notes on storing food. (see 5.1 Information regarding storage)

Note

Accessories can be purchased from the Liebherr Service Center. The address for your respective country can be found on the back of the instructions.

5 Storage

5.1 Information regarding storage



WARNING

Danger of fire

- ▶ Do not use electrical appliances inside the food storage compartments of the appliance, unless they are of the type recommended by the manufacturer.

Note

Insufficient ventilation results in an increase in energy consumption and reduction of the refrigerating performance

- ▶ Always keep the air slots unobstructed.

Observe the following specifications for storage:

- Package or cover foods that readily take on or give off odors or taste in closed containers.
- Package raw meat or fish in clean, closed containers. This will prevent meat or fish from touching or dripping onto other food.
- Keep liquids in closed containers.
- Leave space between goods to ensure good air circulation.
- Store food according to the instructions on the packaging.
- Always observe the best-before date indicated on the packaging.

Note

Failure to follow these guidelines can lead to food-stuffs spoiling.

5.2 Fridge section with pull-out cart

5.2.1 Arranging your food properly

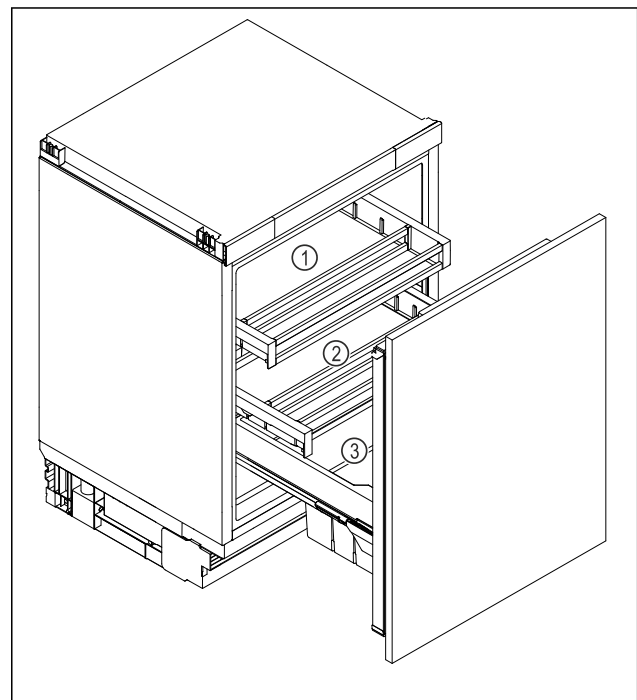

Fig. 6

- ▶ Top drawer Fig. 6 (1): Store butter, cheese, canned food, and tubes.
- ▶ Bottom drawer Fig. 6 (2): Store perishable food, such as pre-cooked meals, fish, fresh meat and lunch meat.
- ▶ Fruit and vegetable box Fig. 6 (3): Store packaged fruit and vegetables.
- ▶ Beverage drawer Fig. 6 (3): Store individual bottles.

5.3 Storage times

The storage times given are guidelines

Energy saving

Food with a “use by” date must still be consumed by the date indicated on the package

5.3.1 Fridge

The best-before date stated on the packaging applies.

6 Energy saving

- Always ensure good ventilation. Keep clear of obstruction all ventilation openings in the appliance enclosure or in the structure for building-in.
- Do not install the appliance in an area with direct sunlight, next to a heating unit or similar.
- If you install the appliance directly next to an oven, its energy consumption may increase slightly. This depends on the service life and how often the oven is used.
- Energy consumption depends on installation conditions such as the ambient temperature (see 1.4 Range of appliance use) . A warmer ambient temperature can increase the energy consumption.
- Avoid opening the appliance door for any longer than necessary
- The lower the temperature is set the higher the energy consumption.
- Only take food out for as long as necessary so that it does not get too warm.
- Insertion of warm foods: first let the food cool down to room temperature.
- For longer periods of absence, use HolidayMode (see HolidayMode) .

7 Use

7.1 Controls and displays

7.1.1 Status display

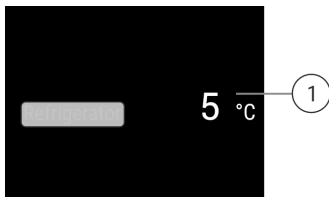







Fig. 7 Status display shows the actual temperature.

- (1) Fridge compartment temperature display

7.1.2 Display symbols

The display symbols provide information about the current appliance status.

Symbol	Appliance status
	Standby The appliance or temperature zone is turned off.

Symbol	Appliance status
	Flashing number Appliance is working. Temperature flashes until the set temperature is reached.
	
	Flashing symbol Appliance is working. Setting is made.
	

7.2 Appliance functions

7.2.1 Notes on the appliance functions

The appliance functions are set at the factory so that your appliance is fully functional.

Before you alter, activate or deactivate the appliance functions, make sure that the following requirements are met:

- You have read and understood the descriptions of how the display works. (see 3 Functionality of the Touch & Swipe display)
- You have familiarized yourself with the operating and display elements of your appliance.



Switching appliance off and on

This function switches the entire appliance on and off.

Switching off the appliance

If you switch off the appliance, the settings that were made before remain stored.

Make sure that the following requirements are fulfilled:

- Handling instructions (see 11 Decommissioning) have been completed.

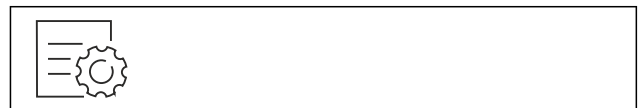

Fig. 8

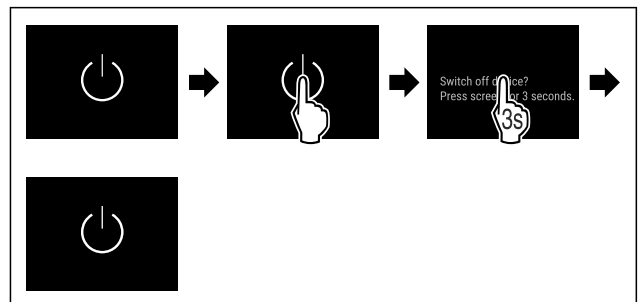

Fig. 9

- Carry out action steps according to the illustration.

- ▷ Appliance is switched off.
- ▷ Standby symbol appears in the display.
- ▷ Display turns black.

Switching on the appliance

If the display is in sleep mode:

- ▶ Briefly touch the display.

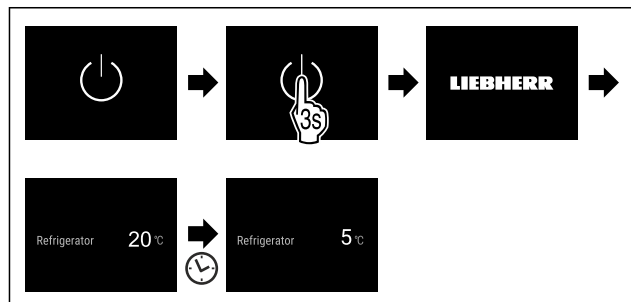

Fig. 10 Example illustration

- ▶ Carry out action steps according to the illustration.
- If the appliance starts in demo mode:
 - ▶ Deactivate demo mode. (see Deactivating demo mode)
 - ▷ Appliance is switched on.
 - ▷ Previously made settings are re-established.
 - ▷ The appliance cools to the set target temperature.



WiFi

Use this function to connect your appliance to WiFi. You can then operate it via the SmartDevice app on a mobile device. You can also use this function to disconnect or reset the WiFi connection.

More information on the SmartDevice: (see 1.3 Smart-Device)

Note

The SmartDevice function is not available in the following countries: Russia, Belarus, Kazakhstan.

Establishing the WiFi connection for the first time

Make sure that the following requirements are fulfilled:

- You have installed the SmartDevice app (see apps.home.liebherr.com).
- Registration in the SmartDevice app is completed.



Fig. 11

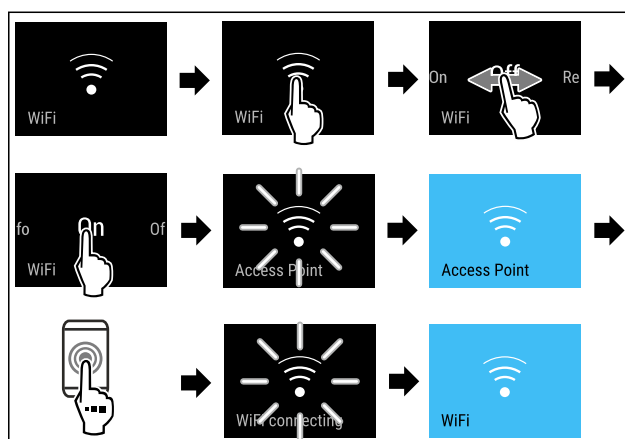

Fig. 12

- ▶ Carry out action steps according to the illustration.
- ▷ Connection is established.

Disconnecting from the WiFi



Fig. 13

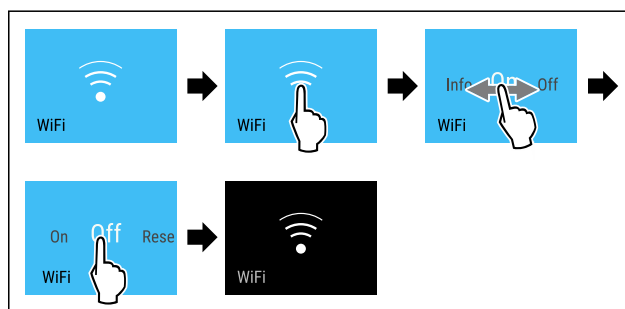

Fig. 14

- ▶ Carry out action steps according to the illustration.
- ▷ There is no connection.

Resetting the WiFi connection



Fig. 15

Use

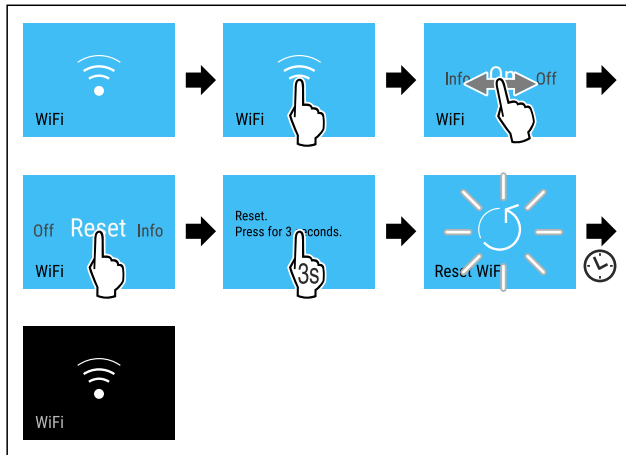

Fig. 16

- ▶ Carry out action steps according to the illustration.
- ▷ WiFi connection and other WiFi settings are reset to factory settings.

Showing information about the WiFi connection



Fig. 17

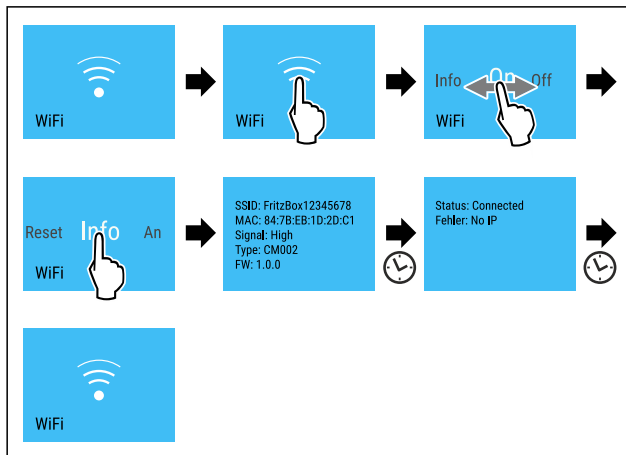

Fig. 18

- ▶ Carry out action steps according to the illustration.

5 °C Temperature

Use this function to set the temperature.

The temperature depends on the following factors:

- How often the door is opened
- How long the door is open
- The room temperature of the installation site
- Type, temperature and amount of food

Temperature zone	Factory-set temperature	Recommended setting
5 °C Fridge section	5 °C (41 °F)	4 °C (39 °F)

Setting the temperature

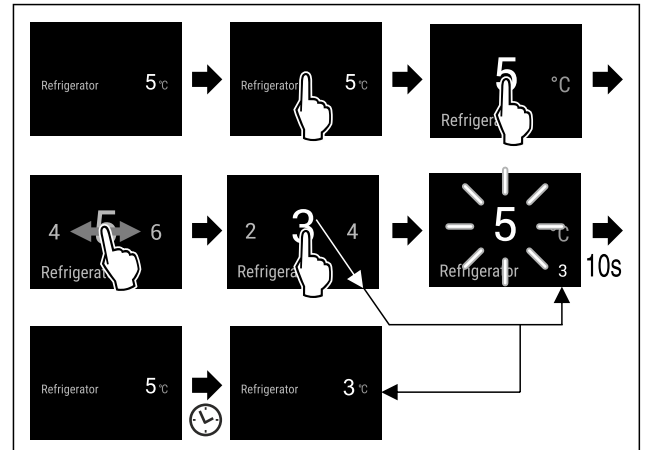

Fig. 19 Example illustration

- ▶ Carry out action steps according to the illustration.
- ▷ Temperature is set.

°C/°F Temperature unit

Use this function to set the temperature unit. You can set the temperature unit in either degrees Celsius or degrees Fahrenheit.

Setting the temperature unit



Fig. 20

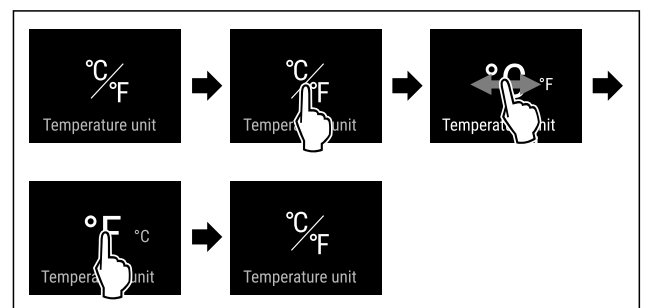

Fig. 21 Example illustration: Switching between degrees Celsius or degrees Fahrenheit.

- ▶ Carry out action steps according to the illustration.
- ▷ Temperature unit is set.

SuperCool

This function activates or deactivates SuperCool. If you activate SuperCool the appliance increases the cooling capacity. This allows you to achieve lower cooling temperatures. You can activate SuperCool if you want to quickly cool large volumes of food.

If the function is active, the appliance operates at a higher output. As a result, the operating noise of the appliance may be temporarily louder, while energy consumption increases.

Activating SuperCool

Time for activating the function:

- If you want to store fresh food in the fridge section:
Activate the function when storing food.

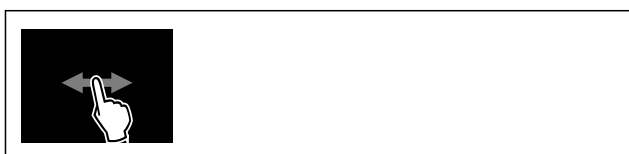

Fig. 22

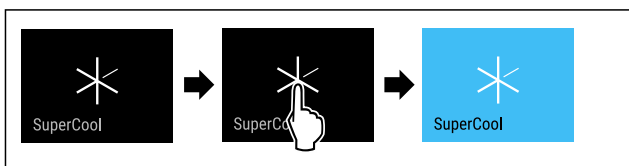

Fig. 23

- ▶ Carry out action steps according to the illustration.

-or-

- ▶ Activating with the SmartDevice app.

- ▷ SuperCool is activated.
- ▷ Temperature display turns blue.

Deactivating SuperCool

SuperCool is automatically deactivated after 18 hours. However, you can also manually deactivate SuperCool at any time:



Fig. 24

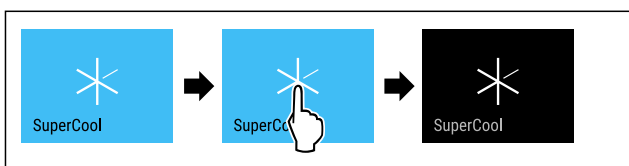

Fig. 25

- ▶ Carry out action steps according to the illustration.

-or-

- ▶ Deactivating with the SmartDevice app.

- ▷ SuperCool is deactivated.
- ▷ Appliance continues to run in normal operation.
- ▷ The appliance first cools to the set temperature.

PartyMode

This function activates and deactivates PartyMode. PartyMode activates different functions that are useful for a party.

PartyMode activates the following functions:

- SuperCool (see SuperCool)

You can set all listed functions individually and flexibly. By deactivating PartyMode all changes are discarded.

If the function is active, the appliance operates at a higher output. As a result, the operating noise of the appliance may be temporarily louder, while energy consumption increases.

Activating PartyMode



Fig. 26



Fig. 27

- ▶ Carry out action steps according to the illustration.
- ▷ PartyMode and the corresponding functions are activated.
- ▷ Temperature display turns blue.
- ▷ The current temperature flashes until the target temperature is reached.

Deactivating PartyMode

PartyMode is automatically deactivated after 24 hours. However, you can also manually deactivate PartyMode at any time:



Fig. 28



Fig. 29

- ▶ Carry out action steps according to the illustration.

Use

- ▷ PartyMode is deactivated.
- ▷ The appliance first cools to the set temperature: The current temperature flashes until the target temperature is reached.



HolidayMode

Use this function to activate or deactivate HolidayMode. If you activate HolidayMode the fridge section is set to 15 °C (59 °F). This helps you save energy if you are away for a longer period of time and avoid bad smells and mold formation.

Appliance status with active HolidayMode
Fridge section cools to 15 °C (59 °F).
PartyMode is deactivated.
SuperCool is deactivated.

Activating HolidayMode

- ▶ Empty the fridge section completely.



Fig. 30

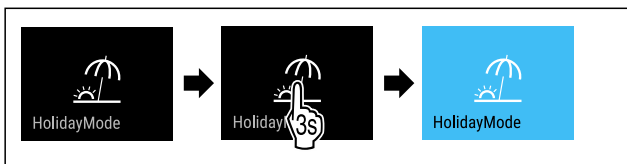

Fig. 31

- ▶ Carry out action steps according to the illustration.
- ▷ HolidayMode is activated.
- ▷ Temperature display turns blue and shows the HolidayMode symbol.

Deactivating HolidayMode



Fig. 32

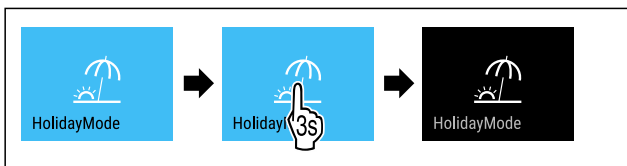

Fig. 33

- ▶ Carry out action steps according to the illustration.
- ▷ HolidayMode is deactivated.
- ▷ The appliance first cools to the set temperature.



SabbathMode

This function activates and deactivates SabbathMode. If you activate this function, some electronic functions are switched off. Your appliance thereby meets the religious requirements of Jewish holidays such as the Sabbath and complies with STAR-K Kosher certification.

Appliance status with active SabbathMode
The status display continuously shows SabbathMode.
All functions in the display except the Deactivating SabbathMode function are disabled.
Active functions remain active.
The display remains bright when you close the door.
The interior lighting is deactivated.
Memories are not listed. The set time interval is stopped.
Memories and warnings are not displayed.
There is no door alarm.
There is no temperature alarm.
After a power failure, the device returns to SabbathMode.

Appliance status

Note

This appliance has certification from the "Institute for Science and Halacha". (www.machonhalacha.co.il)

You can find a list of STAR-K-certified appliances at www.star-k.org/appliances.

Activating SabbathMode



WARNING

Danger of poisoning from spoiled food!

If you have SabbathMode activated and a power failure occurs, no message appears in the status display about the power failure. Once the power is restored, the appliance continues to operate in SabbathMode. The power failure may mean that food spoils and the consumption of this food could lead to food poisoning.

After a power failure:

- ▶ Do not consume food that has been frozen and thawed.



Fig. 34

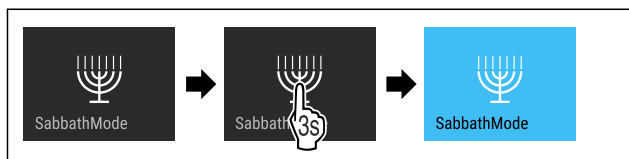

Fig. 35

- ▶ Carry out action steps according to the illustration.
- ▷ SabbathMode is activated.
- ▷ Status display continuously shows SabbathMode.

Deactivating SabbathMode

SabbathMode is automatically deactivated after 80 hours. However, you can also manually deactivate SabbathMode at any time:

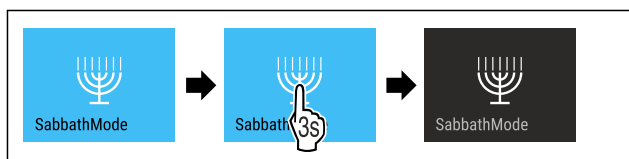

Fig. 36

- ▶ Carry out action steps according to the illustration.
- ▷ SabbathMode is deactivated.

EnergySaver

Use this function to activate or deactivate energy saving mode. If you activate energy saving mode, energy consumption drops and the temperature in the appliance increases. Food remains fresh, but shelf life is reduced.

Temperature zone	Recommended setting (see Setting the temperature)	Temperature while EnergySaver is active
5 °C Fridge section	4 °C (39 °F)	7 °C (45 °F)

Temperatures

Activating EnergySaver



Fig. 37

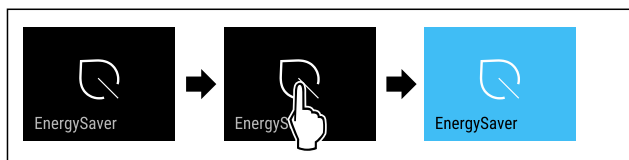

Fig. 38

- ▶ Carry out action steps according to the illustration.
- ▷ Energy saving mode is activated.

Deactivating EnergySaver



Fig. 39

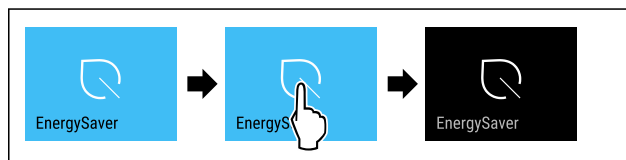

Fig. 40

- ▶ Carry out action steps according to the illustration.
- ▷ Energy saving mode is deactivated.

CleaningMode

This function activates and deactivates CleaningMode. CleaningMode enables you to comfortably clean the appliance.

This setting relates to the fridge compartment.

Application:

- Clean the fridge compartment. (see 9.4 Cleaning the appliance)

Appliance status with active CleaningMode
The status display continuously shows CleaningMode.
The fridge section is switched off.
The interior lighting is activated.
Reminders and warnings are not displayed. No signal tone is sounded.

Appliance status

Activating CleaningMode



Fig. 41



Fig. 42

- ▶ Carry out action steps according to the illustration.
- ▷ CleaningMode is activated.
- ▷ Status display continuously shows CleaningMode.

Deactivating CleaningMode

CleaningMode is automatically deactivated after 60 minutes. However, you can also manually deactivate CleaningMode at any time:

Use



Fig. 43

- ▶ Carry out action steps according to the illustration.
- ▷ CleaningMode is deactivated.
- ▷ The appliance first cools to the set temperature.



Display Brightness

Use this function to set the brightness of the display gradually.

You can set the following brightness levels:

- 40 %
- 60 %
- 80 %
- 100% (default setting)

Setting the brightness

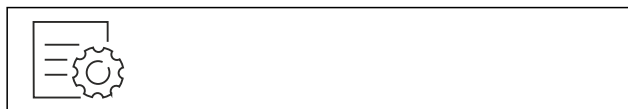

Fig. 44

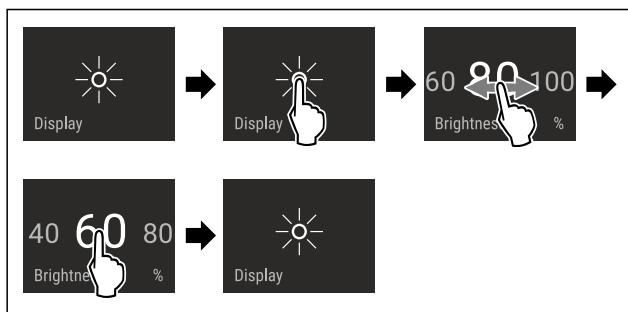

Fig. 45 Example illustration: Switching from 80 % to 60 %.

- ▶ Carry out action steps according to the illustration.
- ▷ Brightness is set.



Door alarm

Use this function to activate or deactivate the door alarm. The door alarm sounds if the door is open for too long. The door alarm is activated upon delivery. You can set how long to door can remain open until the door alarm sounds.

You can set the following values:

- 1 minute
- 2 minutes
- 3 minutes
- Off

Setting the door alarm



Fig. 46

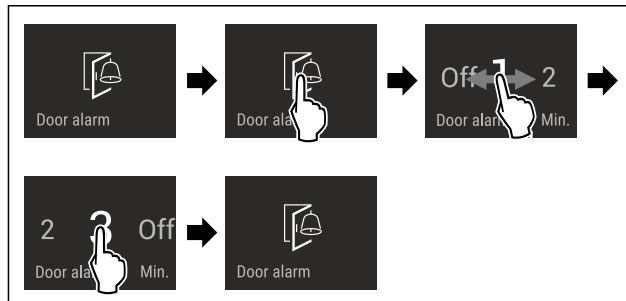

Fig. 47 Example illustration: Changing the door alarm from 1 minute to 3 minutes.

- ▶ Carry out action steps according to the illustration.
- ▷ Door alarm is set.

Deactivating door alarm

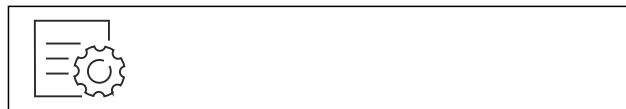

Fig. 49

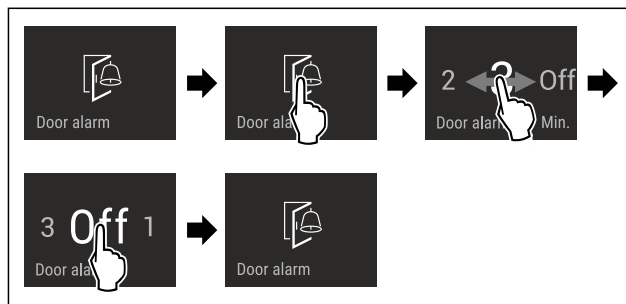

Fig. 50

- ▶ Carry out action steps according to the illustration.
- ▷ Door alarm is deactivated.



Input lock

This function activates and deactivates the input lock. The input lock prevents the appliance from being operated accidentally, e. g. by children.

Application:

- Prevent unintentional changes of functions.
- Prevent switching off of the appliance.
- Prevent unintentional temperature setting.

Activating the input lock

If you activate the input lock, you can continue to navigate in the menus, however you cannot select or modify other functions.



Fig. 51

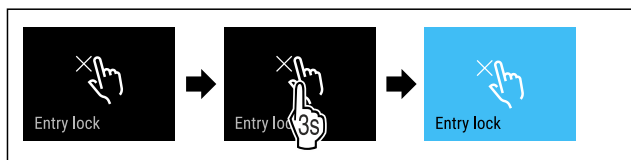

Fig. 52

- ▶ Carry out action steps according to the illustration.
- ▷ Input lock is activated.

Deactivating the input lock



Fig. 53

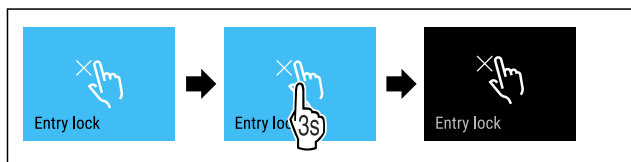

Fig. 54

- ▶ Carry out action steps according to the illustration.
- ▷ Input lock is deactivated.

Language

Use this function to set the display language.

You can set the following languages:

- German
- English
- French
- Spanish
- Italian
- Dutch
- Czech
- Polish
- Portuguese
- Bulgarian
- Russian
- Chinese

Setting the language



Fig. 55

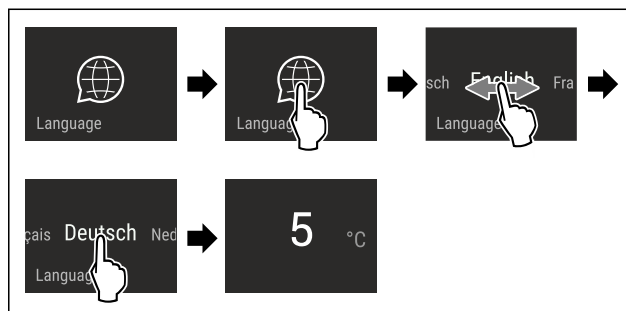

Fig. 56 Example illustration depending on the language and temperature

- ▶ Carry out action steps according to the illustration.
- ▷ Language is set.
- ▷ Display jumps back to the status display.



Appliance information

Use this function to display the model name, index, serial number and service number of your appliance. You will need the appliance information when you contact customer service. (see 10.4 Customer Service) You also use this function to open the expanded menu. (see 3 Functionality of the Touch & Swipe display)

Display appliance information



Fig. 57

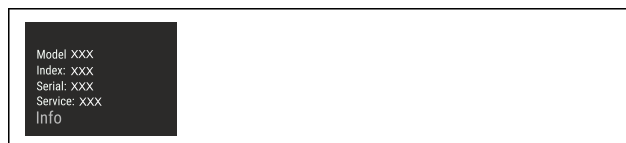

Fig. 58

- ▶ Carry out action steps according to the illustration.
- ▷ Display shows the appliance information.



Software

Use this function to display the software version of your appliance.

Display software version



Fig. 59



Use

Fig. 60

- ▶ Carry out action steps according to the illustration.
- ▷ Display indicates the software version.

Reminder

Use this function to activate or deactivate reminder. This function is activated upon delivery.

The following reminders will then appear if the function is activated:

- Replace the FreshAir activated charcoal filter (see Replace FreshAir activated charcoal filter)

Activating reminder



Fig. 61

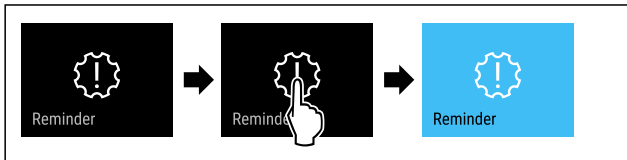

Fig. 62

- ▶ Carry out action steps according to the illustration.
- ▷ Reminder is activated.

Deactivating reminder

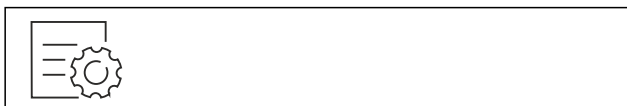

Fig. 63

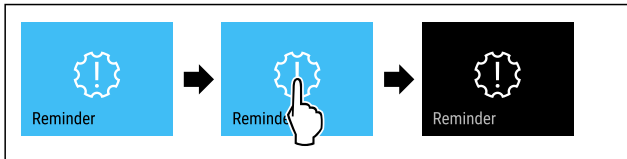

Fig. 64

- ▶ Carry out action steps according to the illustration.
- ▷ Reminder is deactivated.

Demo mode

Demo mode is a special feature for dealers who want to demonstrate appliance features. If you activate demo mode, all refrigeration functions are deactivated. If you switch on your appliance and “Demo” appears in the status display, then demo mode is already activated.

If you activate and then deactivate demo mode, the appliance will be reset to factory defaults. (see Resetting to factory settings)

Activating demo mode



Fig. 65

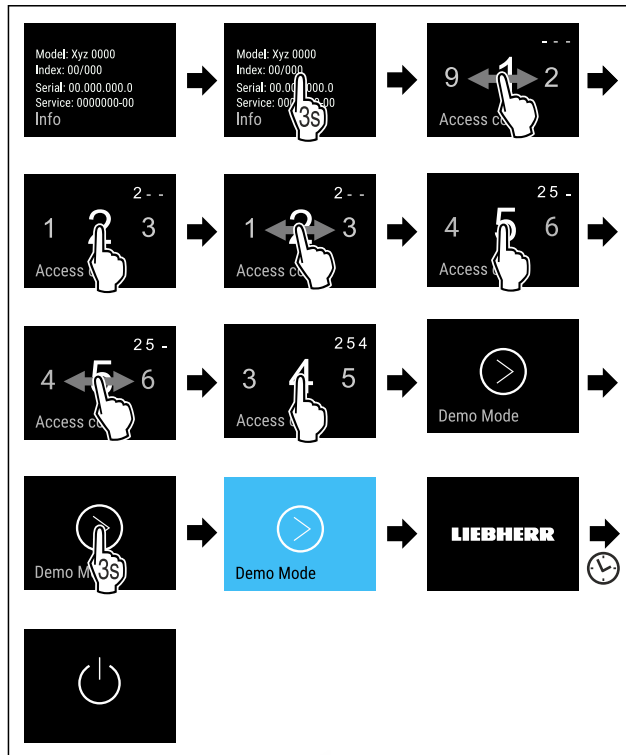

Fig. 66

- ▶ Carry out action steps according to the illustration.
- ▷ Demo mode is activated.
- ▷ Appliance is switched off.
- ▶ Switch on the appliance. (see 4.1 Switching on appliance (first use))
- ▷ “DEMO” appears in the status display.

Deactivating demo mode



Fig. 67

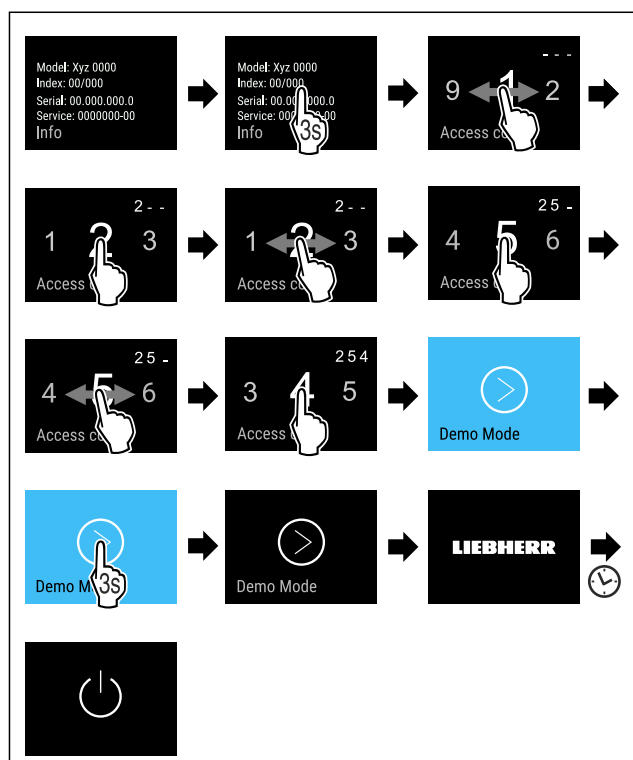

Fig. 68

- ▶ Carry out action steps according to the illustration.
- ▷ Demo mode is deactivated.
- ▷ Appliance is switched off.
- ▶ Switch on the appliance. (see 4.1 Switching on appliance (first use))
- ▷ Appliance is reset to factory settings.

Resetting to factory settings

Use this function to reset all settings to factory settings. All settings you have made so far are reset to their original settings.

Performing a reset

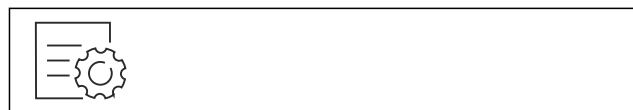

Fig. 69

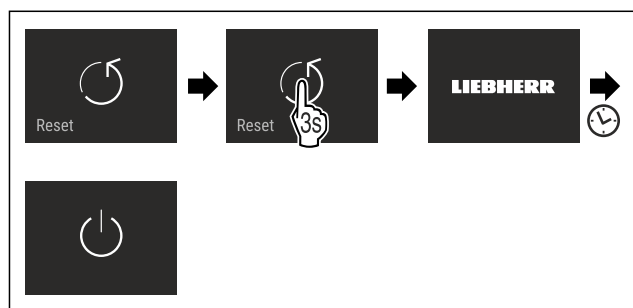

Fig. 70

- ▶ Carry out action steps according to the illustration.

- ▷ Appliance is reset.
- ▷ Appliance is switched off.
- ▶ Restart the appliance. (see 4.1 Switching on appliance (first use))

7.3 Messages

There are two categories of messages:

Category	Meaning
Warning	Warnings are displayed if there is a door alarm or a malfunction. You can easily end warnings yourself. For any major malfunction, you must contact Customer Service. (see 10.4 Customer Service)
Reminder	Reminders remind you of general processes. You can perform these processes and end the message doing so.

7.3.1 Overview of warnings

The appliance's behavior in the event of a warning:

- Warning appears in the display in red.
- Alarm sounds in increasing volume.
- For some warnings the interior lighting pulses.

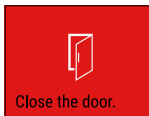
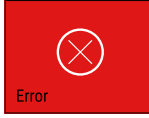
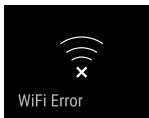
Message	Cause	Ending the message
 Close the door. Door alarm	The message appears if the door is open for too long.	Carry out action steps (see Door alarm) .
 Error Error	This message appears if there is an appliance error. An appliance module indicates an error.	Carry out action steps (see Error) .
 WiFi Error WLAN error	This message appears if the appliance could not be connected to the WLAN. (see Establishing the WiFi connection for the first time)	Carry out action steps (see WLAN error) .

7.3.2 Ending warnings

Door alarm

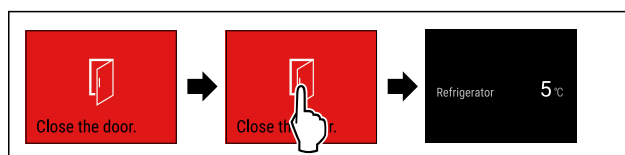

Fig. 71 Example illustration

- ▶ Carry out action steps according to the illustration.

Equipment

-or-

- ▶ Close the door.
- ▷ Display skips to status display.

You can set how long to door may remain open until the door alarm sounds. (see Setting the door alarm)

Error

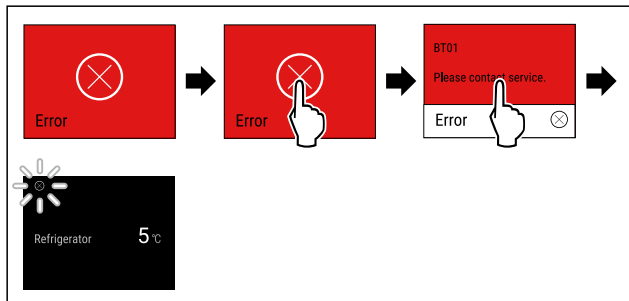

Fig. 72 Example illustration

- ▶ Briefly touch the display.
- ▷ Error code is displayed.
- ▶ Make a note of the error code.
- ▶ Briefly touch the display.
- ▷ Display skips to status display.
- ▶ Contact Customer Service. (see 10.4 Customer Service)

WLAN error

- ▶ Check the WLAN connection.
- ▶ Connect the appliance to the WLAN again. (see WiFi)

7.3.3 Overview of reminders

The appliance's behavior in the event of a reminders:

- Reminder appears in the display in yellow.
- Alarm tone sounds.
- For some reminders the interior lighting pulses.

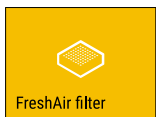
Message	Cause	Ending the message
 Replace the FreshAir activated charcoal filter	This message appears if you have to replace the activated charcoal filter.	Carry out action steps (see Replace FreshAir activated charcoal filter).

7.3.4 Ending reminders

Replace FreshAir activated charcoal filter

Liebherr recommends: Replace the FreshAir activated charcoal filter every 6 months.

Note

FreshAir activated charcoal filters can be purchased from the Liebherr Service Center. The address for your respective country can be found on the back of the instructions.

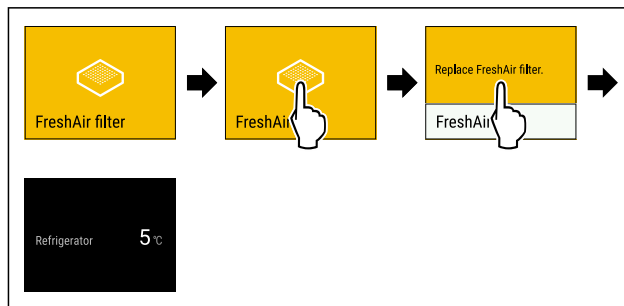

Fig. 73 Example illustration

- ▶ Briefly touch the display.
- ▷ Display shows information about the reminder.
- ▶ Briefly touch the display.
- ▶ Replace activated charcoal filter. (see 9.1 FreshAir carbon filter)
- ▷ The activated charcoal filter ensures optimum air quality in the refrigerator.
- ▷ Reminder appears again after 6 months.

If you no longer want to keep this reminder, you can deactivate the reminder. (see Deactivating reminder)

8 Equipment

8.1 Drawers

You can remove the drawers for cleaning.

The way to remove/insert the drawers varies depending on the pull-out system. Your appliance can contain a variety of pull-out systems.

Note

Insufficient ventilation results in an increase in energy consumption and reduction of the refrigerating performance.

- ▶ Never obstruct the vents on the interior rear wall!

8.2 Butter dish

8.2.1 Opening/closing the butter dish

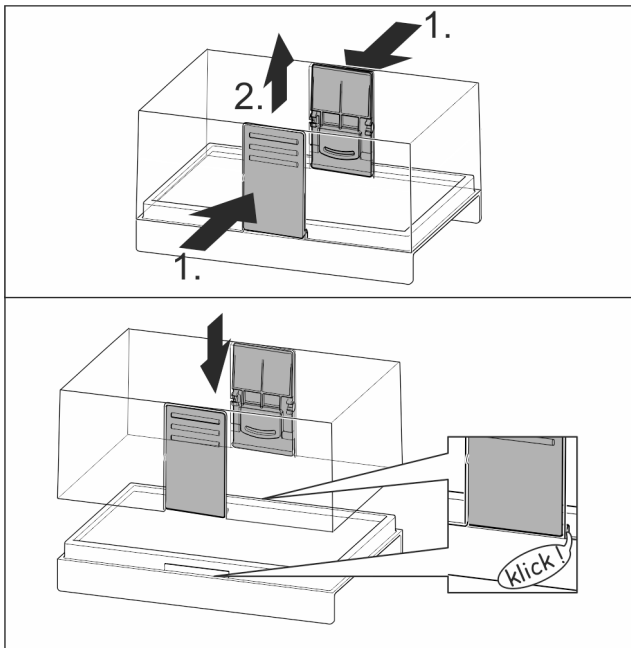

Fig. 74

8.2.2 Dismantling the butter dish

You can disassemble the butter dish for cleaning.

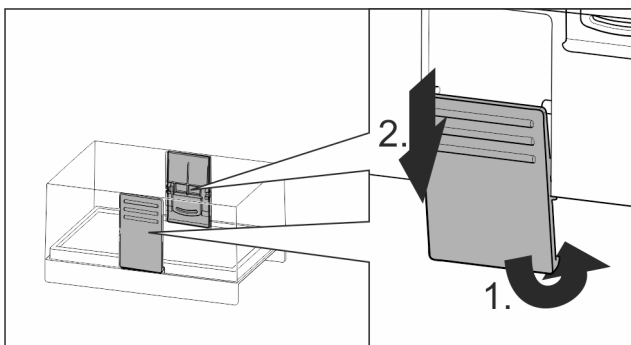

Fig. 75

- Disassemble the butter dish.

8.3 Egg rack

You can pull out and turn the egg rack. You can use both sides of the egg rack so you can label specifics like the purchase date.

8.3.1 Using the egg rack

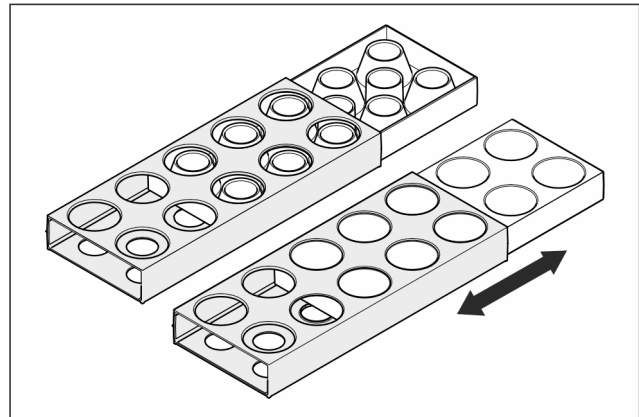

Fig. 76

- Top section: store hen eggs.
- Bottom section: store quail eggs.

8.4 FlexCube

The FlexCube has openings in different sizes so that you can store small items such as tubes, open yogurt cups, or quail eggs in it. The FlexCube fits in all Liebherr door racks, for example. If necessary, you can also place several FlexCubes next to each other.

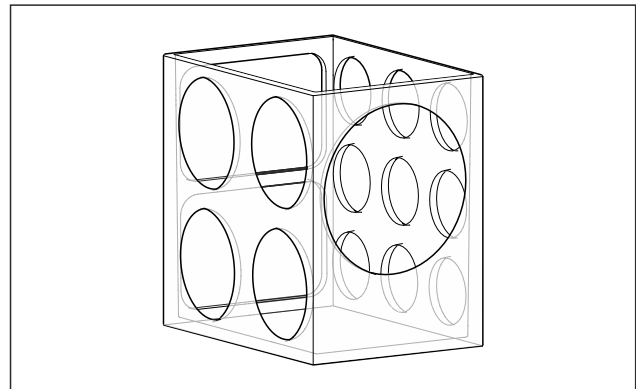
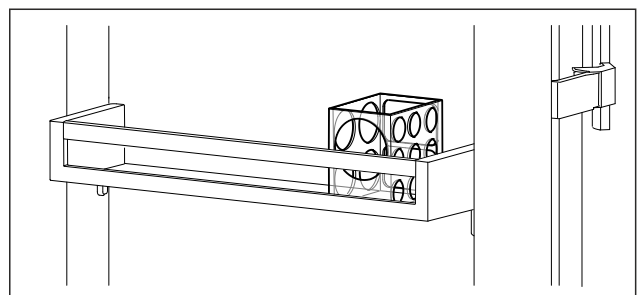

Fig. 77 Example illustration

Note

These accessories can be purchased via the Liebherr Service Center. The address for your respective country can be found on the back of the instructions.

8.4.1 Using FlexCube



Maintenance

Fig. 78 Example illustration

- ▶ Insert the FlexCube in the door rack.
- or-

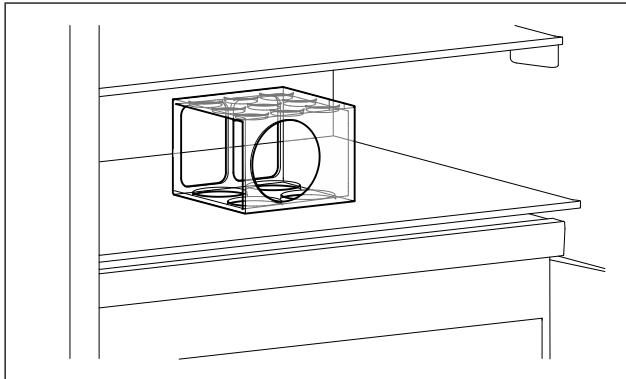

Fig. 79 Example illustration

- ▶ Placing the FlexCube on the shelf.
- ▶ Sort small item in the FlexCube for storage.

9 Maintenance

9.1 FreshAir carbon filter

The FreshAir carbon filter is located in the compartment above the fan. It guarantees the best air quality.

It guarantees the best air quality.

- Change the carbon filter every 6 months. When the reminder is set, a message on the display prompts you to change it.
- You can dispose of the carbon filter with the regular household waste.

Note

FreshAir activated charcoal filters can be purchased from the Liebherr Service Center. The address for your respective country can be found on the back of the instructions.

9.1.1 Removing the FreshAir carbon filter

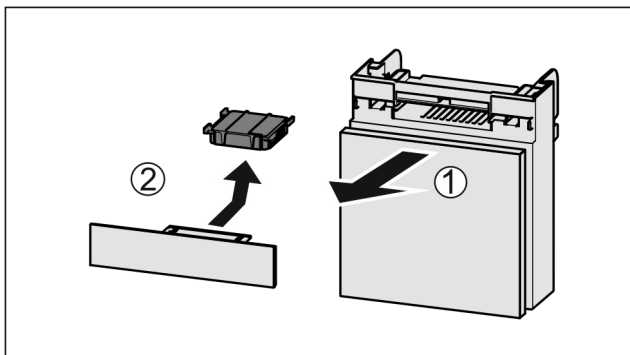

Fig. 80

- ▶ Pull out the compartment Fig. 80 (1).
- ▶ Remove the carbon filter Fig. 80 (2).

9.1.2 Inserting the FreshAir carbon filter

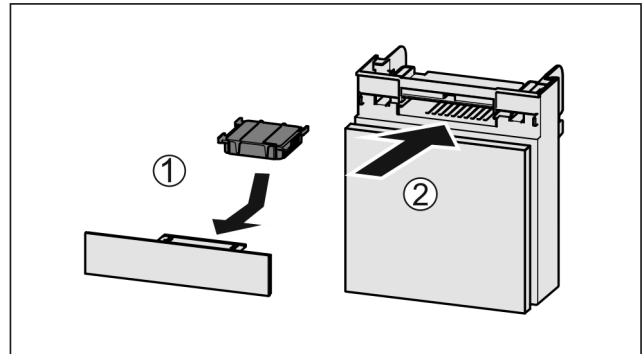

Fig. 81

- ▶ Insert the carbon filter as shown in the diagram Fig. 81 (1).
- ▷ The carbon filter clicks into place. If the carbon filter is pointing downwards:
- ▶ Push the compartment in Fig. 81 (2).
- ▷ The carbon filter is now ready for use.

9.2 Disassembling / assembling pull-out systems

9.2.1 Notes on disassembly

You can disassemble some of the pull-out systems for cleaning. Your appliance can contain a variety of pull-out systems.

The following pull-out systems can be disassembled or cannot be disassembled:

Pull-out system	can be disassembled / cannot be disassembled
Full-extension drawer in the pull-out cart	can be disassembled
Pull-out cart	can be disassembled

9.3 Defrosting the appliance



WARNING

Appliance incorrectly defrosted! Injuries and damage.

- ▶ Do not use mechanical devices or other means to accelerate the defrosting process, other than those recommended by the manufacturer.
- ▶ Do not use any electrical heating or steam cleaning equipment, naked flames or defrosting sprays.
- ▶ Do not remove ice with sharp objects.

Defrosting is performed automatically. The water from the thawing process runs out via the drain opening and is evaporated.

Water droplets or a thin layer of frost or ice can form on the rear wall; this is a completely normal part of the appliance's function. You do not have to remove them.

A frost or ice layer may form briefly due to the energy-optimized control of the appliance.

- ▶ Clean the drain hole regularly. (see 9.4 Cleaning the appliance)

9.4 Cleaning the appliance

9.4.1 Preparation



WARNING

Danger of electric shock.

- ▶ Unplug refrigerator or disconnect power.



WARNING

Danger of fire

- ▶ Do not damage the refrigerant circuit.

- ▶ Empty appliance.
- ▶ Pull out the power plug.

-or-

- ▶ Activate CleaningMode. (see CleaningMode)

9.4.2 Cleaning the interior

NOTICE

Improper cleaning!
Damage to the appliance.

- ▶ Only use soft cleaning cloths and ph-neutral all-purpose cleaners.
- ▶ Do not use steel wool or sponges that scour or scratch.
- ▶ Do not use caustic or abrasive cleaning materials or those containing sand, chloride, or acids.

- ▶ Plastic surfaces: clean by hand with a soft clean cloth, lukewarm water and a little detergent.
- ▶ Metal surfaces: clean by hand with a soft clean cloth, lukewarm water and a little detergent.
- ▶ Drain hole: remove any deposits with a thin item such as a cotton bud.

9.4.3 Cleaning the equipment

NOTICE

Improper cleaning!
Damage to the appliance.

- ▶ Only use soft cleaning cloths and ph-neutral all-purpose cleaners.
- ▶ Do not use steel wool or sponges that scour or scratch.
- ▶ Do not use caustic or abrasive cleaning materials or those containing sand, chloride, or acids.

Clean with a soft, clean cloth, lukewarm water and a little washing up liquid:

- Drawer

Clean with a damp cloth:

- Retracting rails
Please note: the grease in the tracks is there for lubrication purposes and must not be removed!

Clean in the dishwasher up to 60 °C (140 °F):

- Egg rack
- Butter dish
- FlexCube
- ▶ Disassemble the equipment: see the relevant section.
- ▶ Clean the equipment.

9.4.4 After cleaning

- ▶ Wipe dry the appliance and items of equipment
- ▶ Connect and switch on the appliance.
When the temperature is sufficiently cold
- ▶ Place the food inside.
- ▶ Repeat cleaning regularly.

10 Customer support

10.1 Technical specifications

Temperature zone	
Cool:	2 °C (34 °F) to 9 °C (46 °F)

For appliances with a WiFi connection:

Frequency specification	
Frequency band	2.4 GHz
Maximum radiated power	< 100 mW
Purpose of the wireless equipment	Integration in the local WiFi network for data communication

10.2 Operating noises

The appliance makes noises while in operation.

- At **less cooling output** the appliance saves energy but takes longer to cool items. The volume is **lower**.
- At a **higher cooling output** the food cools more quickly. The volume is **higher**.

Examples:

- Activated functions (see 7.2 Appliance functions)
- Freshly sorted food
- High ambient temperature
- Door opened for long periods

Customer support

Noise	Possible cause	Type of noise
Bubbling and splashing	Coolant is flowing into the cooling circuit.	Normal noise
Spitting and hissing	Coolant is spraying into the cooling circuit.	Normal noise
Humming	The appliance cools. The volume depends on the cooling output.	Normal noise
Clicking	Components are being switched on and off.	Normal switching noise
Rattling or humming	Valves are active.	Normal switching noise

Noise	Possible cause	Type of noise	How to resolve
Vibration	Unsuitable installation	Error noise	Check installation. Set up the appliance.

Noise	Possible cause	Type of noise	How to resolve
Clattering	Equipment, Objects inside the appliance	Error noise	Secure equipment parts. Leave a gap between items.

10.3 Technical faults

Your appliance is designed and manufactured for reliable operation and a long service life. If a malfunction nonetheless occurs during operation, please check whether the malfunction is due to an operating error. In this case, you will have to be charged for the costs incurred, even during the warranty period.

You may be able to rectify the following faults yourself.

10.3.1 Appliance function

Defect	Cause	Remedy
The appliance does not work.	The appliance is not switched on.	► Switch on the appliance.
	The power plug is not properly inserted in the wall socket.	► Check the power plug.
	The powerfuse in the wall socket is not OK.	► Check the fuse.
	Power failure.	► Keep the appliance closed.
	The IEC socket is not correctly plugged into the appliance.	► Check the IEC socket.
The temperature is not cold enough	This means that the door of the appliance is not closed properly	► Close the appliance door
	Insufficient ventilation	► Clear and clean the ventilation grille.
	The ambient temperature is too high	► Problem solution: (see 1.4 Range of appliance use)
	The appliance was opened too frequently or for too long	► Wait to see if the required temperature corrects itself. If not, contact Customer Service. (see 10.4 Customer Service)
	The temperature is incorrectly set	► Set to a colder temperature and check after 24 hours.
	The appliance is too near to a heat source (stove, heater etc).	► Change location of appliance or the heat source.

Defect	Cause	Remedy
	The appliance was not properly installed in the recess.	► Make sure the appliance was installed correctly and the door closes properly.

10.3.2 Equipment

Defect	Cause	Remedy
The interior light does not turn on.	The appliance is not switched on.	► Switch on the appliance.
	The door was open for more than 15 minutes.	► If the door is open, the interior lighting switches off automatically after about 15 minutes.
	The LED interior light is faulty or the lid is damaged.	► Contact Customer Service. (see 10.4 Customer Service)

10.4 Customer Service

First check whether you can rectify the fault yourself (see 10 Customer support) . If you cannot rectify the problem, contact Customer Service.

You can find the address in the enclosed brochure "Liebherr-Service" or at home.liebherr.com/service.



WARNING

Unprofessional repair!
Injuries.

- A damaged power cable may only be replaced by the manufacturer, the manufacturer's Customer Service or a similarly qualified person.
- For appliances with plug and play connection cables, the change can be made by the customer.

10.4.1 Contacting Customer Service

Make sure that the following appliance information is available:

- Appliance name (model and index)
- Service no. (service)
- Serial no. (S no.)
- Call up the appliance information via the display. (see Appliance information)
- or-
- Refer to the type plate for appliance information. (see 10.5 Rating plate)
- Take note of the appliance information.
- Notify customer service: Report errors and the appliance information.
- ▷ This will help us give you fast and accurate support.
- Follow further instructions from Customer Service.

10.5 Rating plate

The type plate is on the bottom on the inside of the appliance.

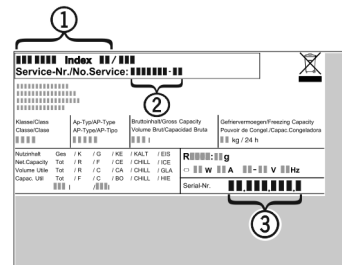

Fig. 82

- (1) Appliance name
- (2) Service no.
- (3) Serial no.
- Information from the nameplate.

11 Decommissioning

- Empty appliance.
- Switch off appliance. (see Switching appliance off and on)
- Pull the power plug from the outlet.
- If necessary, remove the IEC socket: Pull the IEC socket out of the appliance plug while turning it to the left and right at the same time.
- Clean appliance. (see 9.4 Cleaning the appliance)
- Leave the door open to prevent unpleasant odors.

Disposal

12 Disposal

12.1 Preparing the appliance for disposal



WARNING

Risk of child entrapment!

Before you throw away your old refrigerator or freezer:

- ▶ Take off the doors.
- ▶ Leave the shelves in place so that children may not easily climb inside.



Li-Ion

Liebherr uses batteries in some of its appliances. You should remove these before disposal of the old appliance for environmental reasons. If your appliance contains batteries, a corresponding notice is attached to the appliance.

Lamps If you can remove the lamps yourself without destroying them, also remove these before disposal.

- ▶ Take the appliance out of operation.
- ▶ If possible: Remove lamps without destroying them.

12.2 Disposing of the appliance in an environmentally friendly manner



The appliance still contains valuable materials and must be collected separately from unsorted municipal waste so it can be recycled.



Li-Ion



Li-Ion

Dispose of batteries separately from the old appliance. Certain batteries should NOT go in household garbage or recycling bins. Waste batteries can always be recycled or taken to household hazardous waste collection points. To prevent fires from lithium-ion batteries, tape battery terminals and/or place batteries in separate plastic bags and never put these batteries in household garbage or recycling bins.

Lamps Dispose of removed lamps via the respective collection systems.

For USA:

Check the Responsible Appliance Disposal (RAD) program to find a RAD partner near you.

For Canada:

Follow your local guidance about recycling and disposal capabilities near you.



WARNING

Leaking refrigerant and oil!

Fire. The refrigerant contained within the appliance is environmentally friendly, but flammable. The oil contained within the appliance is flammable. Escaping refrigerant and oil can ignite if they are of high enough concentration and are exposed to an external heat source.

- ▶ Do not damage the pipelines of the coolant circuit and the compressor.
- ▶ Observe the notes on appliance transport.
- ▶ Transport the appliance away without damaging it.
- ▶ Dispose of batteries, lamps, and the appliance according to the above specifications.



home.liebherr.com/fridge-manuals

EN Under-worktop refrigerators and freezers, pull-out drawers

Issue date: 20250127

Part number index: 7083772-00

For Service in the U.S.: Liebherr Service Center
Toll Free: 1-866-LIEBHER or 1-866-543-2437
Service-appliances.us@liebherr.com
PlusOne Solutions, Inc.
3501 Quadrangle Blvd, Suite 120
Orlando, FL 32817

For Service in Canada: Liebherr Service Center
Toll Free: 1-888-LIEBHER or 1-888-543-2437
www.euro-parts.ca
EURO-PARTS CANADA
39822 Belgrave Road, Belgrave, Ontario, N0G 1E0
Phone: (519) 357-3320 | Fax: (519) 357-1326