



# Residential and Light Commercial Air Conditioning Systems

Beautifully Designed to Save



# Beautifully Designed to Save



As air conditioners have reached high levels of technological sophistication, the focus on today's air conditioners have transitioned beyond just heating and cooling capabilities to encompass other features, such as design and energy efficiency.

Indeed, LG air conditioners go far beyond the basics, as they present themselves through an aesthetically refined design, making them suitable for any home or office interior décor. Such alluring design is just one of many ways LG air conditioners will enhance your living environment, while providing clean comfortable air.

LG improves your quality of life in an affordable, eco-friendly way. Over the years, LG has strived to meet the demand for high quality air conditioning solutions with greater energy efficiency, helping the environment while also reducing electricity costs for consumers. Greater energy savings are expected over the years, bringing remarkable cost savings to your home and business.

Furthermore, LG's air conditioners are sturdy, reliable products with prolonged lifespans designed to provide years of worry-free performance.



Over the past decade, LG has devoted its utmost in both capability and effort into the North American HVAC market. LG promises to continue offering consumers products that go far beyond their expectations.

# The LG HVAC Advantage

## Take advantage of our smart solutions for residential & commercial air conditioning applications.

LG HVAC systems offer a range of solutions that are cost efficient, quiet and attractive. They provide a smart alternative to both central HVAC and window-mounted air conditioners, and are available in a variety of configurations to suit different cooling and heating situations.

### Split Systems

These innovative systems are “split” into indoor and outdoor units. The interior units are available in several different configurations: Art Cool™, standard wall-mounted, and ceiling cassettes. All interior units have remote controls for easy use. Installation by a qualified HVAC contractor is safe and easy – no duct work or sheet metal is required. Single, dual and tri-zone systems are also available.

### Through-The-Wall Models

LG's Through-The-Wall models offer versatile, energy efficient solutions for residential and light commercial applications. Both cooling and heat/cool models are available in a variety of capacities, with most models ENERGY STAR® qualified. The standard size chassis fits into any competitive sleeve, making upgrades a breeze.

### PTAC Models

LG's new PTAC units are perfect for lodging and healthcare applications. These units have an extremely low decibel level and outstanding sound prevention rating. Plus, LG's efficient PTAC models contribute to excellent energy savings.

### Feature Advantages:

Look for these key features throughout the LG line.

- **Attractive, Customizable Indoor Units.** Art Cool™ provides numerous options to complement any décor. The Art Cool™ Gallery Panel looks like a picture frame – any art or photograph can be displayed. Other Art Cool™ units come in a black or white finish to suit any room.

- **Multi Power System.™** Energy-saving twin compressors: one provides power at 60% capacity until the system reaches a desired temperature.



Then the smaller compressor takes over to provide sustained operation at 40% capacity.

- **INVERTER V** Inverter heat pump air conditioners use a variable speed compressor, rather than the constant speed compressor found in conventional ACs. Instead of shutting off once the desired temperature is reached, the inverter compressor continues to operate at low speed to maintain that temperature. The AC unit is quieter to

operate and uses less energy than conventional ACs, which cycle on and off.



- **R-410A Refrigerant.** Ozone-friendly refrigerant utilized in all of LG systems.

NOTE: R-410A service port access will require a special adapter to attach standard 1/4" hoses. Ask your equipment supplier for more details.

- **Art Cool™ Self-Cleaning Indoor Coil.** Drives dirt and moisture from coil surface leaving it clean.
- **Dehumidifying Mode.** Indoor unit accurately senses room temperature and controls humidity by shutting down the compressor before a room is over-cooled.
- **Chaos Wind.** Electronically controlled fan speeds create a more natural, random flow of air, reducing temperature stratification.
- **Art Cool™ Three-way Cooling.** Air flows out of the unit from three directions, creating more natural circulation.
- **Jet Cool.** Operates at high speed for up to 30 minutes to quickly cool a room down to 64° F.
- **Swirl Wind.** 4-Way controlled louvers and fan speeds create a stronger, wider air flow and reduce temperature stratification.
- **Auto Operation.** Provides three levels of comfort from which to choose. Temperature and fan speed will set automatically.
- **Manual Power Switch.** Easily accessed button allows for continued operation if the remote control is misplaced.
- **Defrost Control.** Shuts down the indoor fan to prevent cold air from being blown into the zone. Removes frost from outdoor coil when the outdoor temperature is low.
- **Temperature Display.** Shows room temperature measured by the indoor unit.
- **Auto Sleep Mode.** Automatically increases the temperature setting 2° F twice (after 1/2 hour and one hour). The interior unit shuts off when the timer setting is reached.
- **Auto Restart.** Automatically restarts a unit to programmed setting when the electricity comes on after a power failure.
- **Gold Fin™.** All DFS system outdoor unit coils have a corrosion resistant GoldFin™ coating standard from the factory. GoldFin™ will promote sustainable efficiency and coil life by helping to prevent corrosion caused by everyday pollutants.

NOTE: All features are not available on all models. See product pages for details.

# Art Cool™ Premier Single Zone

**INVERTER V**

## Supreme Energy Efficiency

The advanced inverter technology, high efficiency heat exchanger, and improved efficiency of the compressor and inverter drive provide the highest level of energy efficiency.

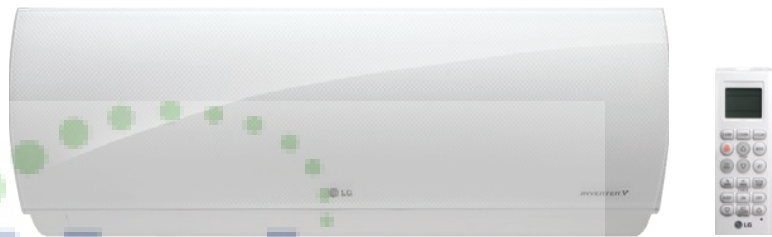

Indoor Unit with Remote

## Ultra Quiet

LG air conditioners operate at world class sound levels, thanks to LG's unique new cross-flow fan and BLDC motor technology.



Outdoor Unit

**INVERTER V**





**AjMadison**  
Your Appliance Authority™  
800-570-3355

LG Air Conditioner **Art Cool™ Premier**  
Inverter V

In addition to stylish design, LG Art Cool™ Premier brings with it an unrivaled package of the most complete air conditioning solutions.

Supreme  
Energy  
Efficiency



SEER  
**28.0**  
(LS090HYV)

Top Tier Energy  
Efficiency

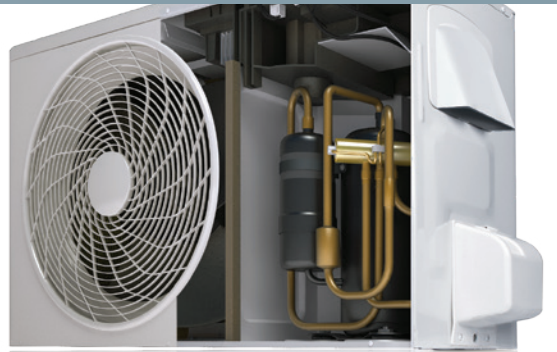

Ultra Quiet

**17dB(A)**

Sound Level  
(Sleep Mode)

BLDC Motor / Cross-Flow Fan



**800-570-3355**

### Model View



Supreme  
Energy Efficiency



BLDC Motor



Ultra  
Quiet



Quick & Easy  
Installation



Stylish Design

# Unique Features

**Supreme Energy Efficiency** State of the art heat exchanger, air outlet, compressor, and inverter technology provide the world's highest energy efficiency.



**Indoor Unit :** Strategically designed heat exchanger and air outlet contribute to the efficient usage of energy while providing maximum cooling.

1



**Outdoor Unit :** The advanced compressor and inverter technology of LG enables the user of the air conditioner to use more and save more.

2

**Ultra Quiet** LG's unique new cross-flow fan and low vibrating compressor technology provides extreme silence and comfort for the user.



**Indoor Unit :** With fan blades 25% larger than the previous cross-flow fan, the sound level has been decreased even lower to 17dB(A) - more silent than a library.

3



**Outdoor Unit :** The interior of the compressor in the outdoor unit has been constructed to minimize the sound produced during operation.

4

**Optimized Airflow** The optimized design of the air outlet provides strong airflow which cools the room temperature up to 5 degrees in as few as 5.6 minutes.



4-way swing disperses cool air quickly and effectively in multiple directions to each corner of the room.

**Heating** Use more and save more with the highly efficient LG Heat Pump system and inverter technology. LG delivers the promise of warm comfort.



Use more and save more with the highly efficient LG Heat Pump system and inverter technology. LG delivers the promise of warm comfort.

**Stylish Design** LG air conditioners are not just refreshingly efficient, but also exceptionally elegant in design.



The design of LG air conditioners are stylish in a way that is incomparable to others. Think of it not just as an air conditioner, but an object that will lighten up your room.

5

**Quick & Easy Installation** Installation has never been easier than with the conveniently designed installation elements of LG air conditioners.



Perfect finishing / More tubing space / Installation plate improvement / Detachable bottom cover / Elevated service valve / Installation support clip.

6

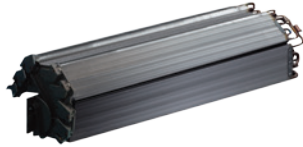

1 3 Row Heat Exchanger



2 DC Inverter

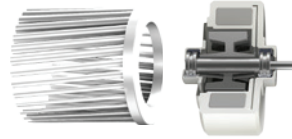

3 Cross-Flow Fan & BLDC Motor

4 Twin Rotary Compressor

Stylish Design

5

6 Quick & Easy Installation



# Supreme Energy Efficiency



The revolutionary inverter technology of LG boasts powerful yet silent performance while minimizing energy consumption by as much as 74%.

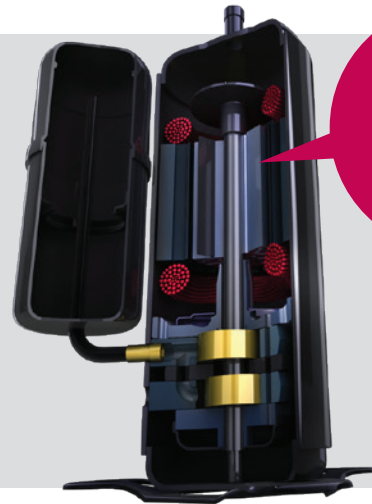

**Top Class**  
Efficiency  
**28.0**  
SEER

(LS090HYV)  
AHRI #5265353  
(4/27/2012)

Unique Features

## 1 3 Row Hybrid Heat Exchanger

Previous - 2 Row

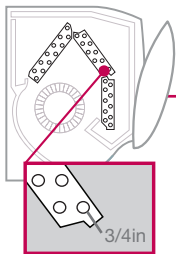

New - 3 Row

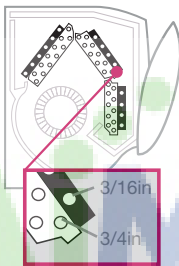

Improved energy efficiency by application of 3 Row hybrid heat exchanger

- The efficiency of the heat exchanger has been greatly enhanced by adding an additional row to the hybrid heat exchanger - increasing the surface area.
- The loss of capacity has been reduced by using tubes of varying diameter.

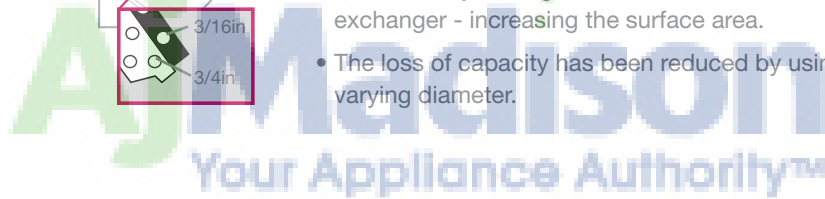

## 2 Improved Cross-Flow Fan

By reducing the second vortex which constricts airflow within the air outlet and enlarging the fan size by 25%, the amount of airflow increased from 424 CFM to 547 CFM.

### Streamline Constructed Air Outlet

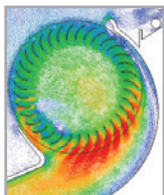

Previous

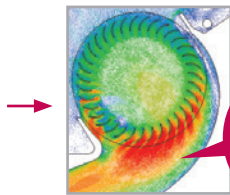

New

Improved Air Velocity Distribution



### Increased Fan Size

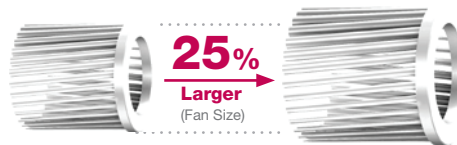

Previous : 3-1/4in

New : 4in



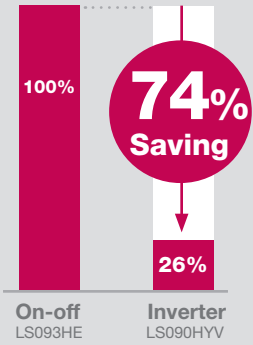

**Heating Season**

**LG In-House Standard**  
 Temperature Setting : 73.4F  
 Outside Temperature : 44.6F  
 Electricity consumed to reach the set-point temperature

**Total Electricity Consumption Comparison**

Model	Total Consumption (kWh)	Energy Saving Rate
Non INV LS093HE	1.2	74%
INV LS090HYV	0.31	

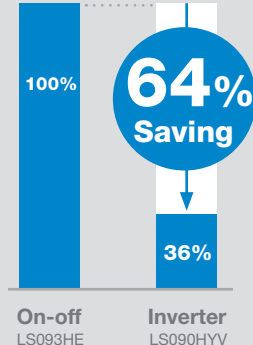

**Cooling Season**

**KSC 9306 Monthly Energy Consumption**  
 On-off : Electricity Consumed x Operation Factor x Time Used x Days Used  
 Inverter : SEER calculation method

**KSC 9306 Electricity Consumption Comparison**

Model	Cooling Power (kW)	Monthly Consumption (kWh)	Energy Saving Rate
Non INV LS093HE	3.5	280.8	64%
INV LS090HYV	3.5	100.6	

### 3 High Efficiency Twin Rotary Compressor

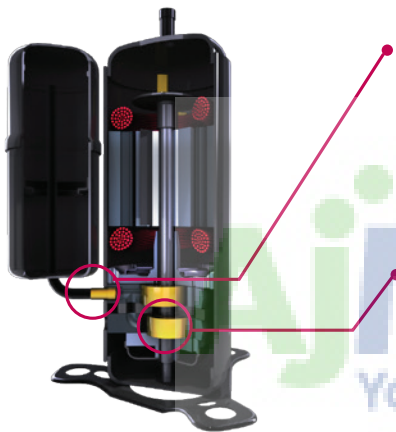

#### 1 Suction Rotary Compressor

The number of suctions have been reduced from two to one to increase the efficiency of refrigerant compression during the more frequently occurring low speed range.

#### Motor Efficiency

The DC motor in LG air conditioner compressors boasts world class efficiency levels.

### 4 Improved Inverter Drive Efficiency

#### How It Works

While energy loss is incurred in the process of switching voltage between AC & DC, inverter drive keeps this loss minimal for improved energy efficiency.

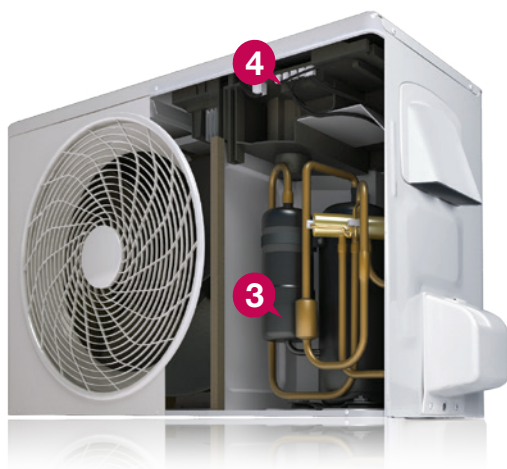
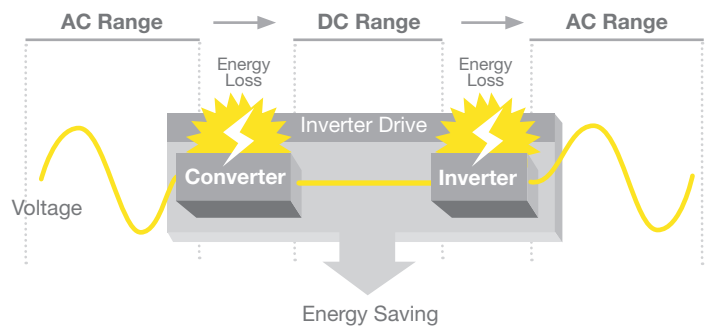

# Ultra Quiet



LG's unique new cross-flow fan and low vibrating compressor technology have achieved world class sound levels even more quiet than a library!

## Low Noise 17dB(A)

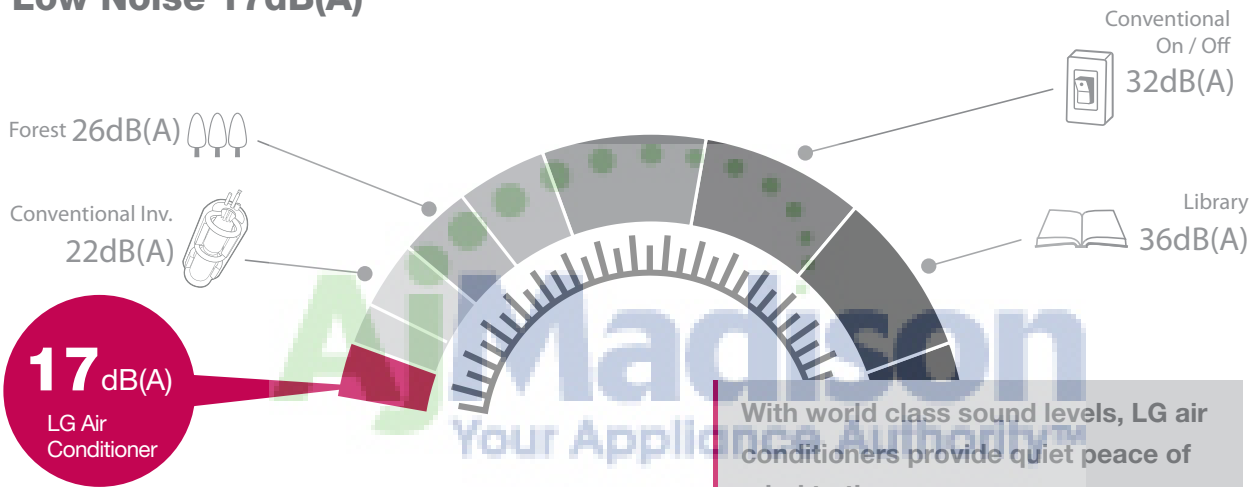

With world class sound levels, LG air conditioners provide quiet peace of mind to the user.

800-570-3355





### 1 LG Unique Cross-Flow Fan

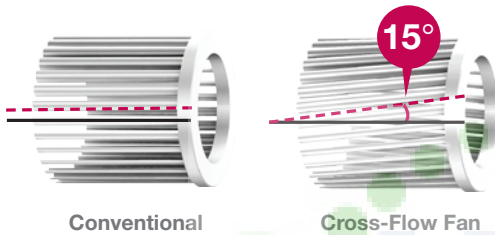

By minimizing the surface pressure of the fan blade when in contact with the air, the peak noise is reduced to a level that is among the lowest in the world.

### 2 BLDC Fan Motor

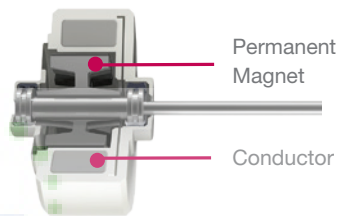

With strong torque and powerful Neodymium magnetism inside the rotor, the BLDC motor provides large air volume and high static pressure.

Precise speed control provides 13 different steps which makes operation smoother. Both electrical and mechanical noise is more silent, and high speed operation is available.

### 3 Low Vibration Compressor

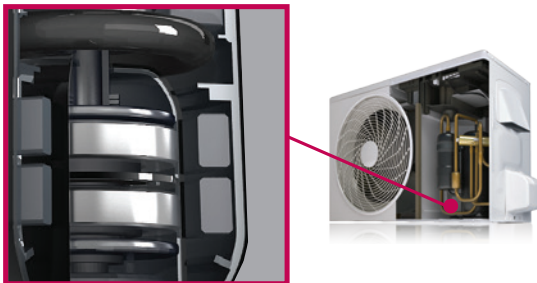

With a unique design that reduces the vibration of the twin rotary compressor while simultaneously applying double cam, the torque variation is reduced by 40% compared to a single rotary compressor.

#### Single Rotary VS Twin Rotary

The balanced stability of a twin rotary compressor keeps the vibration minimal.

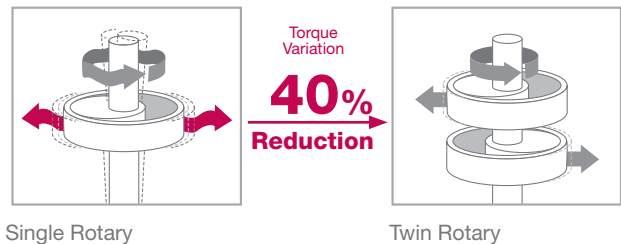

**AjMadison**  
Your Appliance Authority  
800-570-3355

# Optimized Airflow

## Jet Cool



The optimized design of the air outlet provides strong airflow which cools the room temperature up to 41°F in as few as 5.6 minutes time.



41°F



## Jet Cool

Jet Cool disperses air evenly at high speed to ensure the room is optimally cool in as few as 5.6 minutes.

- The optimized air outlet design increases the velocity of internal circulation by 20%.

## Faster Cooling

Reaching the set-point temperature is up to 3 times faster than non-inverter models.

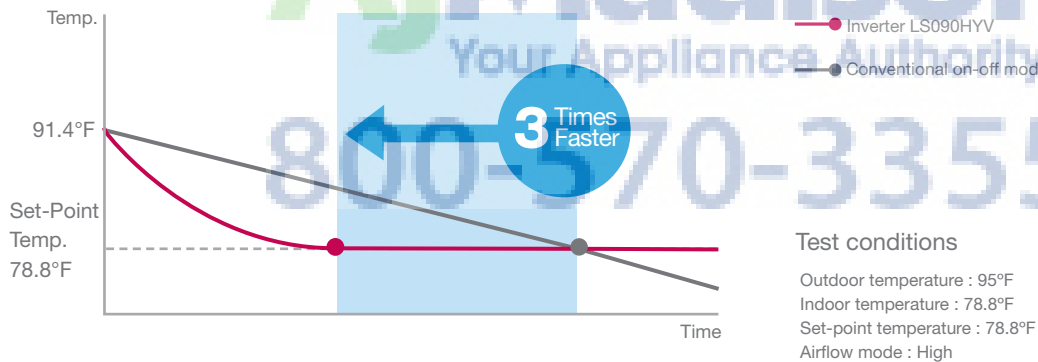

## How we achieved ever powerful performance

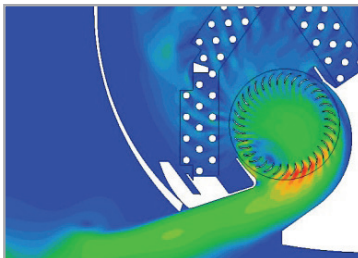

Increasing the fan size by 25% and reducing the second vortex (which constricts airflow within the air outlet) resulted in an overall increase to the amount of airflow.

# Optimized Airflow

## 4-Way Swing



LG air conditioners can deliver cool air to every corner of your room. The 4-way swing function blows the air quickly and efficiently in multiple directions.



## 4-Way Swing

4-way swing disperses cool air quickly and effectively in multiple directions to each corner of the room.

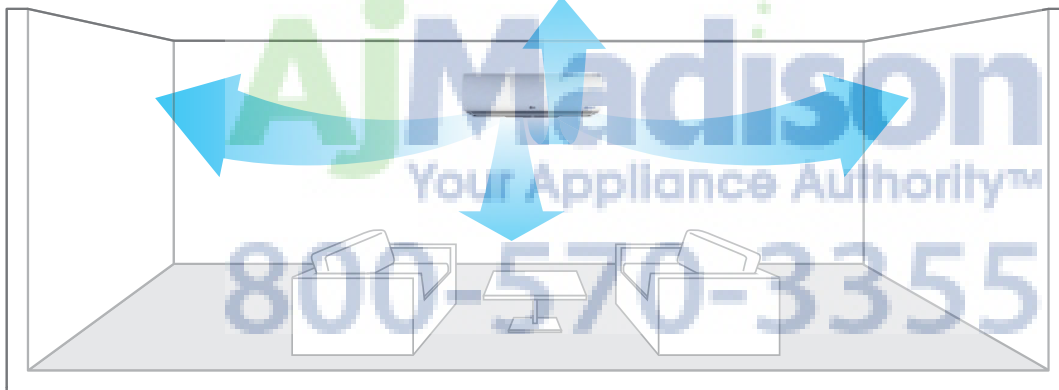

- Direction of horizontal vane can be adjusted from step 1 to step 6 with full auto swing. This function can cool specific areas much faster.
- Direction of vertical louver can be adjusted from step 1 to step 5, left & right, with full auto swing. This function also allows the air conditioner to cool specific areas in only a short period of time.
- 4-way swing provides optimized airflow regardless of your location in the room.

### 6 Step Horizontal Vane

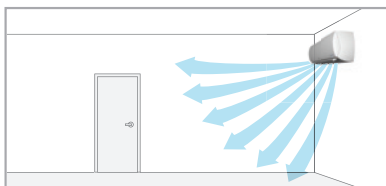

### 5 Step Vertical Louver

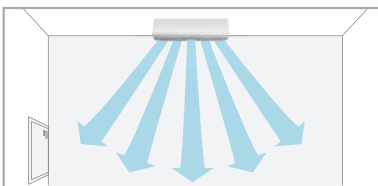

### Optimized Airflow



# Heating

## High Efficiency



Use more and save more with the highly efficient LG Heat Pump system with inverter technology. LG delivers the promise of warm comfort.

## Efficient Heat Pump System

LG Heat Pumps save up to 80% more energy than electric heaters.

While it takes the simultaneous operation of four electric heaters that consume 4.0kW of electricity, one LG inverter air conditioner requires only 0.8kW of electricity to deliver the same capacity.

### Electric Heaters



13657.7Btu/hr Heat Energy Output

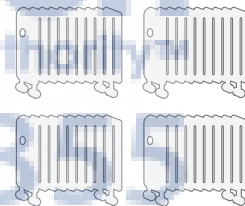

Energy Consumption

**4.0kW**

### LG Heat Pump

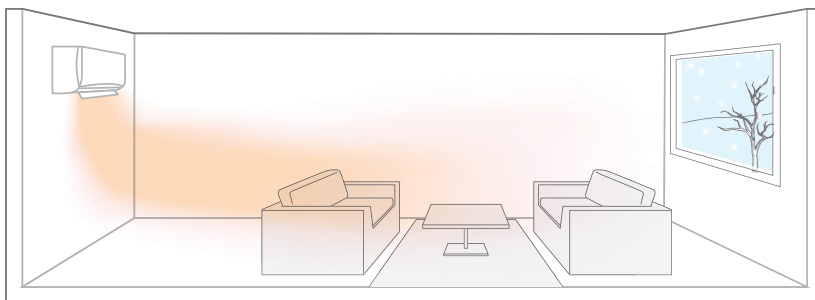

13657.7Btu/hr Heat Energy Output



Energy Consumption

**0.8kW**

Inverter model : LS120HYV

Test conditions

Outdoor temperature : 44.6°F Set-point temperature : 73.4°F

Test conditions assuming general Electric Heaters' electric power consumption is 1000W



## Inverter Technology

Heat pump products have been receiving a considerable amount of attention recently for their energy-saving effects. In fact, inverter heat pump products have significantly higher energy efficiency than constant-speed, non-inverter units. As a result, LG Inverter products can help you save up to 74% more energy when heating. Use of an energy efficient inverter system can also help decrease your carbon footprint by reducing overall energy consumption.

### Energy Saving when Heating

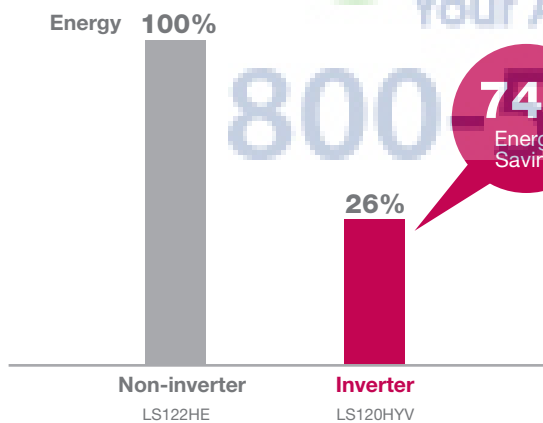

**AjMadison**  
Your Appliance Authority™  
800-770-3355

Inverter model : LS120HYV  
 Non-inverter model : LS122HE  
 Electricity consumed in reaching the set-point temperature  
 Test conditions  
 Outdoor temperature : 44.6°F  
 Set-point temperature : 73.4°F

Unique Features

# Heating

## Power Heating



LG air conditioners heat a wider space in a shorter period of time, creating a warm and comfortable living environment.

## Rapid Comfort

Prompt heating of the room is enabled by reaching the designated room temperature in a shorter period of time.

### Quick Heating

Reaching the set-point temperature is 6.3 times faster than other air conditioners.

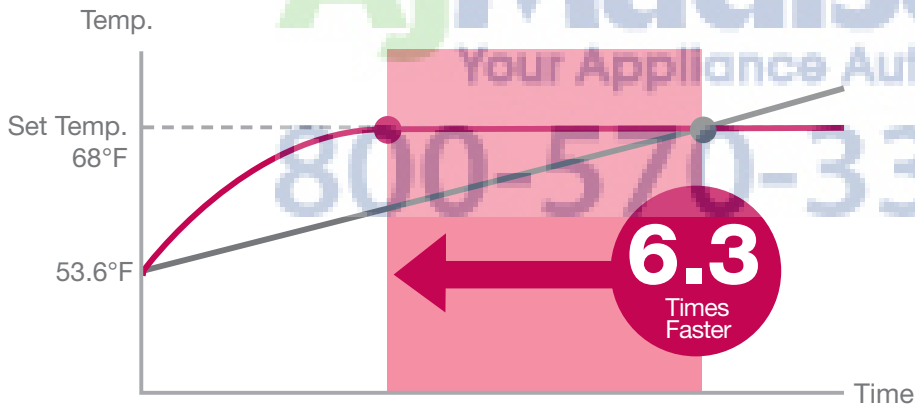

- Inverter LS120HYV
- Conventional on- off model

### Test conditions

Outdoor temperature : 44.6°F  
Indoor temperature : 53.6°F  
Setting temperature : 68°F  
Airflow mode : High

Unique Features



## Optimized Airflow

### 39 feet Powerful Airflow

LG's new larger fans allow you to feel the air up to 39 feet away. That means heating is fast and powerful, and helps you feel warm sooner.

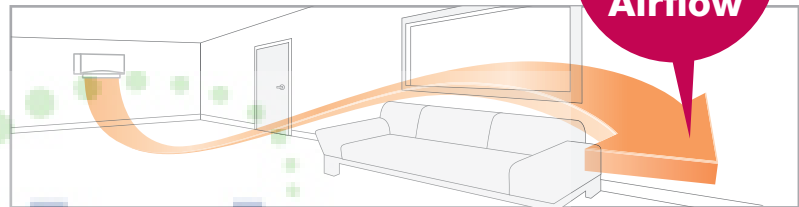

### Vertical 6 Steps & Horizontal 5 Steps

6 Vertical Steps / longer reach of airflow  
5 Horizontal Steps / balanced distribution of airflow to distant corners

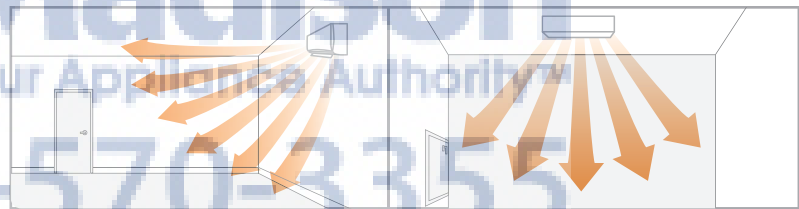

### Easy Airflow Control

The LG air conditioning units can automatically distribute air in 4 directions.

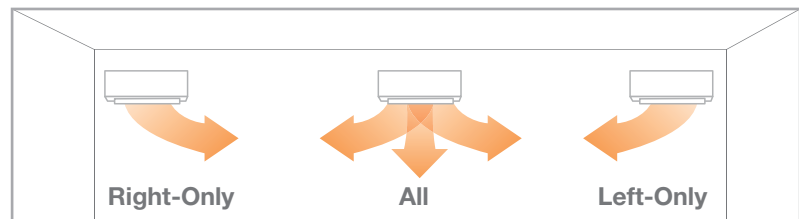

Wind Direction Control allows the setting of airflow directions according to the location of the air conditioner.

### Vertical Airflow

For heating, the vane sends the heated air downwards to maintain pleasant and balanced room temperature.

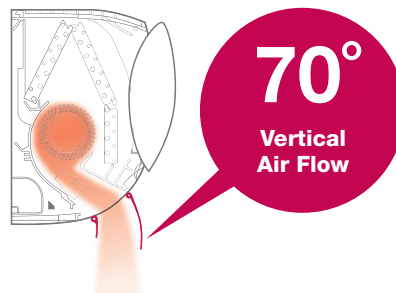

## Stylish Design



The design of LG air conditioners are stylish in a way that is incomparable to others. Think of it not just as an air conditioner, but a decoration that will lighten up your living room.

## Art Cool™ Premier



### Stylish Pattern

Stylishly pearlized patterned front cover

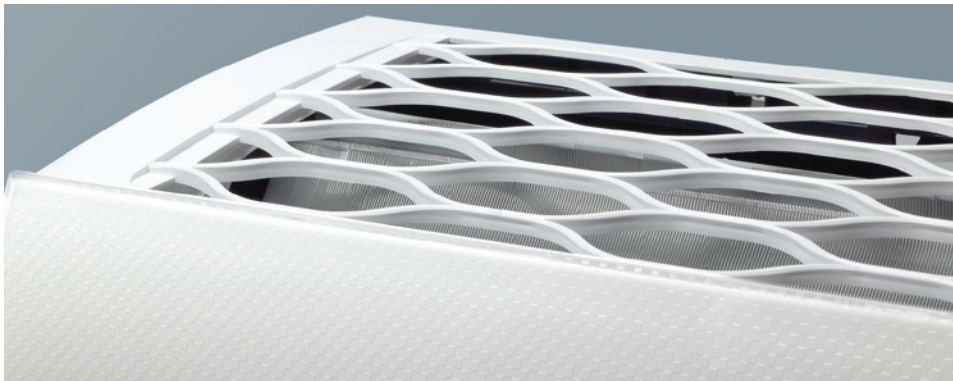

### Honeycomb Air Inlet

Air inlet in the unique shape of honeycombs



### Elegant Movement

The elegance in style has been greatly enhanced with the flawless movement of the vane



### Discrete Display

With no separate or noticeable display panel, the discreet LED display is only visible when the air conditioner is operational

# Easy Installation



LG air conditioners are designed to be easier and more efficient to install, regardless of the surroundings and the number of persons involved in the installation process.

## Perfect Finishing

Extra wide cover holds the tubing assembly and hides the unorganized parts behind the indoor unit, making the indoor unit appear clean and tidy.

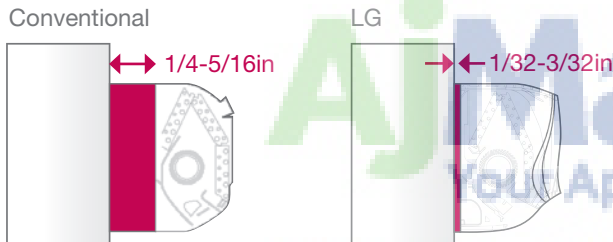

- Wider area and cover for piping & drain hose arrangements
- Additional wide cover for holding tubing assembly

## Wider Tubing Space

The tubing space is much wider than typically offered by competitors and facilitates the whole installation process.

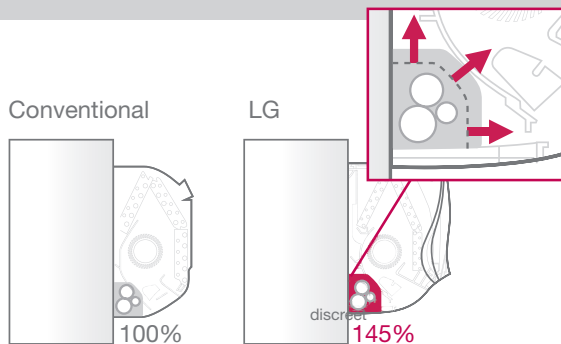

- The tubing space is 45% wider than that of the previous air conditioners for easier installation.

## Installation Plate Improvement

LG's installation plate is wider and modified to reduce installation time.



- The instruction tip engraved in the plate also assists easy installation by not having to go through the install manual

## Detachable Bottom Cover

The bottom cover is detachable when needed, making installation easier.

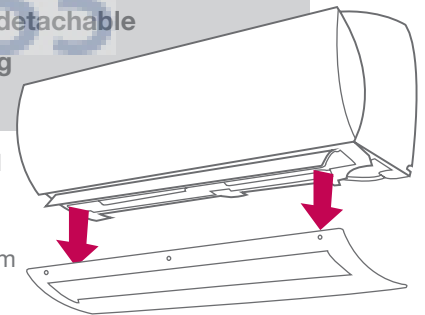

- Disassembly or additional supporting of the unit is unnecessary due to the detachable chassis bottom and supporter
- With LG's patented supporter, installation can be completed by one individual.

## Installation Support Clip

A support clip creates adequate space between wall and unit for easier installation.

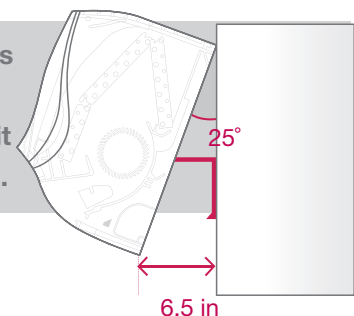

Aj Madison  
Your Appliances Authority  
800-570-3355

# High Wall Duct-Free Art Cool™ Premier Supreme Efficiency Single Zone



9,000 BTUs / 12,000 BTUs

## LS090HYV (H/P Model)

● 9,000 BTUs Cooling

● 11,000 BTUs Heating

## LS120HYV (H/P Model)

● 12,000 BTUs Cooling

● 13,600 BTUs Heating



**INVERTER V**



## FEATURES:

- Inverter (Variable speed compressor)
- Energy saving
- R-410A refrigerant
- Gold Fin™ anti-corrosion
- Self-cleaning indoor coil
- Cooling/Heating/Fan mode
- Jet cool/Jet heat
- Chaos wind
- 4-Way auto swing

- Ultra quiet operation
- Sleep mode
- Dehumidifying mode
- Auto restart
- Auto changeover
- Built-in low ambient standard, down to 14°F (Cooling mode)
- 24-Hour on/off timer
- Condensate sensor connection

### Interior Unit Includes:

- Wall unit
- Installation plate & hardware
- Remote control, batteries, holder & holder hardware
- Installation manual
- Optional accessories
  - Model#:PQRCVSL0(QW) (Wired wall thermostat)
  - Model#: PMNFP14A0

(PL485 V-net interface)

### Exterior Unit Includes:

- Exterior unit
  - Exterior unit has sufficient refrigerant for charging indoor coil and a 25' line set (Line set not included)
- ETL# : 3091879

\* Specification can be changed without notification

System Model #	LS090HYV	LS120HYV
Indoor Model #	LSN090HYV	LSN120HYV
Outdoor Model #	LSU090HYV	LSU120HYV
<b>Performance</b>		
Capacity (BTUs)	● 9,000 ● 11,000	● 12,000 ● 13,600
EER	16.4	14.1
SEER	28.0	26.0
HSPF	12.0	11.5
Air Circulation (CFM H/M/L)	512 / 406 / 300	512 / 406 / 300
Fan Speeds	6/Auto/Chaos	6/Auto/Chaos
Dehumidification (pts/hr)	3.3	3.7
Indoor dB(A)*	39/34/26/17	39/34/26/17
Outdoor dB(A)*	51	51
<b>Electrical</b>		
Rated Voltage Outdoor	230/208-60-1	230/208-60-1
Rated Voltage Indoor	230/208-60-1	230/208-60-1
<b>Indoor Dimensions</b>		
W x H x D (inches)	34 3/8 x 11 5/8 x 9 1/4	34 3/8 x 11 5/8 x 9 1/4
Weight (lbs.)	25.3	25.3
<b>Outdoor Dimensions</b>		
W x H x D (inches)	34 1/4 x 25 13/16 x 12 5/8	34 1/4 x 25 13/16 x 12 5/8
Weight (lbs.)	94.8	94.8
<b>Thermostat Range</b>		
Cooling / Heating (°F)	64-86/60-86	64-86/60-86

\*LG verified sound ratings

Warranty: 3 years parts; 5 years compressor.

# ART COOL™

## Art Cool™ Gallery Single Zone

### Customized Good Looks

The slim, contemporary styling of the Art Cool™ models will appeal to today's discerning customer. The 9,000 and 12,000 BTU picture models come with a frame that allows the customer to modify and personalize the unit with their own artwork or photography – the ultimate in custom design.



High Wall Duct-Free  
Art Cool™ Indoor Unit  
Customizable Picture Art Panel

Art Cool™ Duct-Free Mini-Split Air Conditioning Systems from LG enhance the economics of duct-free technology. Now you can bring more attractive, cost-effective solutions to your commercial and residential customers.

# 800-570-3355



Indoor Unit with Remote



Outdoor Unit



\*Art Cool™ Gallery 9,000-12,000 BTUs units only

# High Wall Duct-Free Art Cool™ Gallery Single Zone



**9,000 BTUs**

**12,000 BTUs**

**LA096HNP (H/P Model)**

**C** 9,900 BTUs Cooling

**H** 9,900 BTUs Heating

**LA126HNP (H/P Model)**

**C** 11,500 BTUs Cooling

**H** 11,000 BTUs Heating



## FEATURES:

- Customizable art panel
- R-410A refrigerant
- Self-cleaning indoor coil
- Dehumidifying mode
- Chaos wind
- 3-Way cooling
- Jet cool
- Cooling mode
- Fan mode
- Auto operation

- Manual power switch
- Defrost control
- Auto sleep mode
- Auto restart
- Built-in low ambient standard, down to 14°F (Cooling mode)
- 24-Hour on/off timer
- Evaporator frost control
- Gold Fin™ anti-corrosion
- Plasma air purifying system

### Interior Unit Includes:

- Wall unit
- Installation plate & hardware
- Remote control, batteries, holder & holder hardware
- Installation manual

### Exterior Unit Includes:

- Exterior unit
- Exterior unit has sufficient refrigerant for charging indoor coil and a 25' line set (Line set not included)

ETL# : 3091879

Specification can be changed without notification

System Model #	LA096HNP	LA126HNP
Indoor Model #	LAN096HNP	LAN126HNP
Outdoor Model #	LAU096HNP	LAU126HNP
<b>Performance</b>		
Capacity (BTUs)	<b>C</b> 9,900 <b>H</b> 9,900	<b>C</b> 11,500 <b>H</b> 11,000
EER	9	10
SEER	13	13
HSPF	7.7	7.7
Air Circulation (CFM H/M/L)	330/261/194	330/261/194
Fan Speeds	4/Auto/Chaos	4/Auto/Chaos
Dehumidification (pts/hour)	3.0	3.0
Indoor dB(A)*	43/35/29	43/35/29
Outdoor dB(A)*	48	48
<b>Electrical</b>		
Rated Voltage Outdoor	115-60-1	115-60-1
Rated Voltage Indoor	36V DC	36V DC
<b>Indoor Dimensions</b>		
W x H x D (inches)	23 5/8 x 23 5/8 x 5 3/4	23 5/8 x 23 5/8 x 5 3/4
Weight (lbs.)	33.1	33.1
<b>Outdoor Dimensions</b>		
W x H x D (inches)	30 5/16 x 21 5/16 x 9 5/8	30 5/16 x 21 5/16 x 9 5/8
Weight (lbs.)	70.5	70.5
<b>Thermostat Range</b>		
Cooling / Heating (°F)	64-86/60-86	64-86/60-86

\*LG verified sound ratings

Warranty: 3 years parts; 5 years compressor.

# Art Cool™ Premier & Art Cool™ Gallery Single Zone Electrical & Refrigeration Quick Reference

Electrical Specifications									
Zone	Type	Model	BTUs	Voltage		Rated Amps	MCA*	MOP**	
				Indoor	Outdoor				
<b>Art Cool™ Premier Single Zone</b>	H/P	<b>C</b> <b>H</b> LS090HYV	9,000	230/208	230/208	8.7	10	15	
	H/P	<b>C</b> <b>H</b> LS120HYV	12,000	230/208	230/208	8.7	10	15	
<b>Art Cool™ Gallery Single Zone</b>	H/P	<b>C</b> <b>H</b> LA096HNP	9,900	36V DC	115	10.5	14.3	20	
	H/P	<b>C</b> <b>H</b> LA126HNP	11,500	36V DC	115	10.5	14.3	20	

All equipment single phase.

NOTE: Please see local electrical codes for proper wire specifications.

\*Minimum Circuit Ampacity

\*\*Maximum Overcurrent Protection



Refrigerant Line Specifications***									
Zone	Type	Model	BTUs	Pipe Size		Additional Refrigerant	Max. Pipe Length	Max. Elevation	
				Liquid	Suction				
<b>Art Cool™ Premier Single Zone</b>	H/P	<b>C</b> <b>H</b> LS090HYV	9,000	1/4"	3/8"	0.22 oz./ft.	49'	32'	
	H/P	<b>C</b> <b>H</b> LS120HYV	12,000	1/4"	3/8"	0.22 oz./ft.	49'	32'	
<b>Art Cool™ Gallery Single Zone</b>	H/P	<b>C</b> <b>H</b> LA096HNP	9,900	1/4"	1/2"	0.22 oz./ft.	49'	23'	
	H/P	<b>C</b> <b>H</b> LA126HNP	11,500	1/4"	1/2"	0.22 oz./ft.	49'	23'	

Please choose a proper wire size based on local and state code

# High Wall Duct-Free High Efficiency

## Air Conditioners Single Zone

LG Electronics' products have led the global air conditioner market with excellent performance and innovative design. The Art Cool™ Mirror and standard models are a brilliant addition to LG's lineup. These are high-performance air conditioners with high efficiency and excellent design.



Indoor Unit



Outdoor Unit



\* Energy Star is only eligible for LA090HSV2, LA120HSV2, LA180HSV, not LA240HSV



**INVERTER V**

# High Wall Duct-Free Art Cool™ Mirror High Efficiency Single Zone

9,000 BTUs / 12,000 BTUs

## LA090HSV2 (H/P Model)

- C 9,000 BTUs Cooling
- H 10,800 BTUs Heating

## LA120HSV2 (H/P Model)

- C 11,200 BTUs Cooling
- H 13,300 BTUs Heating



**INVERTER V**



## FEATURES:

- Inverter (Variable speed compressor)
- Energy saving
- R-410A refrigerant
- Gold Fin™ anti-corrosion
- Self-cleaning indoor coil
- Cooling/Heating/Fan mode
- Jet cool/Jet heat
- Chaos wind
- 4-Way auto swing

- Ultra quiet operation
- Sleep mode
- Dehumidifying mode
- Auto restart
- Auto changeover
- Built-in low ambient standard, down to 14°F (Cooling mode)
- 24-Hour on/off timer
- Condensate sensor connection
- Plasma air purifying system

### Interior Unit Includes:

- Wall unit
- Installation plate & hardware
- Remote control, batteries, holder & holder hardware
- Installation manual
- Optional accessories  
-Model#:PQRCVSL0(QW)  
(Wired wall thermostat)

### Exterior Unit Includes:

- Exterior unit
- Exterior unit has sufficient refrigerant for charging indoor coil and a 41' line set (Line set not included)

ETL# : 3091879



\* Specification can be changed without notification

System Model #	LA090HSV2	LA120HSV2
Indoor Model #	LAN090HSV2	LAN120HSV2
Outdoor Model #	LAU090HSV2	LAU120HSV2
<b>Performance</b>		
Capacity (BTUs)	C 9,000 H 10,800	C 11,200 H 13,300
EER	13.3	12.5
SEER	20	20
HSPF	11.0	11
Air Circulation (CFM H/M/L)	350/280/210	350/280/210
Fan Speeds	6/Auto/Chaos	6/Auto/Chaos
Dehumidification (pts/hr)	2.6	3.0
Indoor dB(A)*	38/33/24	39/33/24
Outdoor dB(A)*	45	45
<b>Electrical</b>		
Rated Voltage Outdoor	230/208-60-1	230/208-60-1
Rated Voltage Indoor	230/208-60-1	230/208-60-1
<b>Indoor Dimensions</b>		
W x H x D (inches)	35 1/4 x 11 1/4 x 8 1/16	35 1/4 x 11 1/4 x 8 1/16
Weight (lbs.)	24.3	24.3
<b>Outdoor Dimensions</b>		
W x H x D (inches)	30 5/16 x 21 7/16 x 11 5/16	30 5/16 x 21 7/16 x 11 5/16
Weight (lbs.)	77.2	77.2
<b>Thermostat Range</b>		
Cooling / Heating (°F)	64-86/60-86	64-86/60-86

\*LG verified sound ratings

Warranty: 3 years parts; 5 years compressor.

Product



# High Wall Duct-Free Art Cool™ Mirror High Efficiency Single Zone

18,000 BTUs / 24,000 BTUs

**LA180HSV2 (H/P Model)**    **LA240HSV2 (H/P Model)**  
 C 18,200 BTUs Cooling    C 22,000 BTUs Cooling  
 H 22,000 BTUs Heating    H 27,600 BTUs Heating



**INVERTER V**



## FEATURES:

- Inverter (Variable speed compressor)
- Energy saving
- R-410A refrigerant
- Gold Fin™ anti-corrosion
- Self-cleaning indoor coil
- Cooling/Heating/Fan mode
- Jet cool/Jet heat
- Chaos wind
- 4-Way auto swing
- Ultra quiet operation
- Sleep mode
- Dehumidifying mode
- Auto restart
- Auto changeover
- Built-in low ambient standard, down to 14°F (Cooling mode)
- 24-Hour on/off timer
- Condensate sensor connection
- Plasma air purifying system

### Interior Unit Includes:

- Wall unit
- Installation plate & hardware
- Remote control, batteries, holder & holder hardware
- Installation manual
- Optional accessories
  - Model#: PQRCVSL0(QW) (Wired wall thermostat)
  - Model#: PMNFP14A0 (PI485 V-net interface)

### Exterior Unit Includes:

- Exterior unit
- Exterior unit has sufficient refrigerant for charging indoor coil and a 25' line set (Line set not included)

ETL# : 3091879



\* Energy Star is only eligible for LA180HSV2, not LA240HSV2

\* Specification can be changed without notification

System Model #	LA180HSV2	LA240HSV2
Indoor Model #	LAN180HSV2	LAN240HSV2
Outdoor Model #	LAU180HSV2	LAU240HSV2
<b>Performance</b>		
Capacity (BTUs)	C 18,200 H 22,000	C 22,000 H 27,600
EER	12.6	10.8
SEER	20.5	20.0
HSPF	9.7	10.0
Air Circulation (CFM H/M/L)	600/510/420	600/510/420
Fan Speeds	6/Auto/Chaos	6/Auto/Chaos
Dehumidification (pts/hr)	5.5	5.5
Indoor dB(A)*	45/40/35	45/40/35
Outdoor dB(A)*	53	53
<b>Electrical</b>		
Rated Voltage Outdoor	230/208-60-1	230/208-60-1
Rated Voltage Indoor	230/208-60-1	230/208-60-1
<b>Indoor Dimensions</b>		
W x H x D (inches)	40 9/16 x 12 13/16 x 9 7/8	40 9/16 x 12 13/16 x 9 7/8
Weight (lbs.)	37.5	37.5
<b>Outdoor Dimensions</b>		
W x H x D (inches)	34 5/16 x 31 1/2 x 12 5/8	34 5/16 x 31 1/2 x 12 5/8
Weight (lbs.)	132.3	132.3
<b>Thermostat Range</b>		
Cooling / Heating (°F)	64-86/60-86	64-86/60-86

\*LG verified sound ratings

Warranty: 3 years parts; 5 years compressor.

# High Wall Duct-Free High Efficiency Single Zone



**9,000 BTUs**

**LS091HSV2 (H/P Model)**

**C** 9,000 BTUs Cooling

**H** 10,800 BTUs Heating



**INVERTER V**



## FEATURES:

- Inverter (Variable speed compressor)
- Energy saving
- R-410A refrigerant
- Gold Fin™ anti-corrosion
- Self-cleaning indoor coil
- Cooling/Heating/Fan mode
- Jet cool/Jet heat
- Chaos wind
- 4-Way auto swing
- Ultra quiet operation

- Sleep mode
- Dehumidifying mode
- Auto restart
- Auto changeover
- Built-in low ambient standard, down to 14°F (Cooling Mode)
- 24-Hour on/off timer
- Condensate sensor connection
- Plasma air purifying system

### Interior Unit Includes:

- Wall unit
- Installation plate & hardware
- Remote control, batteries, holder & holder hardware
- Installation manual
- Optional accessories
- Model#:PQRCVSL0(QW) (Wired wall thermostat)
- Model#:ZLABGP01A (Low ambient wind baffle kit - cooling down to 0°F)

### Exterior Unit Includes:

- Exterior unit
  - Exterior unit has sufficient refrigerant for charging indoor coil and a 41' line set (Line set not included)
- ETL# : 3091879

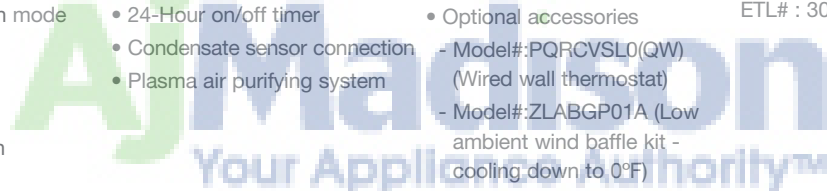

\* Specification can be changed without notification

System Model #	LS091HSV2
Indoor Model #	LSN091HSV2
Outdoor Model #	LSU091HSV2
<b>Performance</b>	
Capacity (BTUs)	<b>C</b> 9,000 <b>H</b> 10,800
EER	13.3
SEER	20
HSPF	11.0
Air Circulation (CFM H/M/L)	350/280/210
Fan Speeds	6/Auto/Chaos
Dehumidification (pts/hr)	2.6
Indoor dB(A)*	38/33/24
Outdoor dB(A)*	45
<b>Electrical</b>	
Rated Voltage Outdoor	230/208-60-1
Rated Voltage Indoor	230/208-60-1
<b>Indoor Dimensions</b>	
W x H x D (inches)	35 1/4 x 11 1/4 x 8 1/4
Weight (lbs.)	22.1
<b>Outdoor Dimensions</b>	
W x H x D (inches)	30 5/16 x 21 1/2 x 11 5/16
Weight (lbs.)	77.2
<b>Thermostat Range</b>	
Cooling / Heating (°F)	64-86/60-86

\*LG verified sound ratings

Warranty: 2 years parts; 5 years compressor.

Product

# High Wall Duct-Free High Efficiency Single Zone



**12,000 BTUs**

**LS121HSV2 (H/P Model)**

**C**11,200 BTUs Cooling

**H**13,300 BTUs Heating



**INVERTER V**



**FEATURES:**

- Inverter (Variable speed compressor)
- Energy saving
- R-410A refrigerant
- Gold Fin™ anti-corrosion
- Self-cleaning indoor coil
- Cooling/Heating/Fan mode
- Jet cool/Jet heat
- Chaos wind
- 4-Way auto swing
- Ultra quiet operation

- Sleep mode
- Dehumidifying mode
- Auto restart
- Auto changeover
- Built-in low ambient standard, down to 14°F (Cooling Mode)
- 24-Hour on/off timer
- Condensate sensor connection
- Plasma air purifying system

- Interior Unit Includes:**
- Wall unit
  - Installation plate & hardware
  - Remote control, batteries, holder & holder hardware
  - Installation manual
  - Optional accessories
  - Model#:PQRCVSLQ(QW) (Wired wall thermostat)
  - Model#:ZLABGP01A (Low ambient wind baffle kit - cooling down to 0°F)

- Exterior Unit Includes:**
- Exterior unit
  - Exterior unit has sufficient refrigerant for charging Indoor coil and a 41' line set (Line set not included)
- ETL# : 3091879

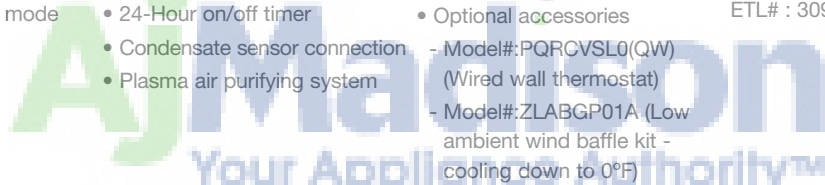

\* Specification can be changed without notification

System Model #	LS121HSV2
Indoor Model #	LSN121HSV2
Outdoor Model #	LSU121HSV2
<b>Performance</b>	
Capacity (BTUs)	<b>C</b> 11,200 <b>H</b> 13,300
EER	12.5
SEER	20
HSPF	11.0
Air Circulation (CFM H/M/L)	350/280/210
Fan Speeds	6/Auto/Chaos
Dehumidification (pts/hr)	3.0
Indoor dB(A)*	39/33/24
Outdoor dB(A)*	45
<b>Electrical</b>	
Rated Voltage Outdoor	230/208-60-1
Rated Voltage Indoor	230/208-60-1
<b>Indoor Dimensions</b>	
W x H x D (inches)	35 1/4 x 11 1/4 x 8 1/4
Weight (lbs.)	22.1
<b>Outdoor Dimensions</b>	
W x H x D (inches)	30 5/16 x 21 1/2 x 11 5/16
Weight (lbs.)	77.2
<b>Thermostat Range</b>	
Cooling / Heating (°F)	64-86/60-86

\*LG verified sound ratings

Warranty: 2 years parts; 5 years compressor.

Product

# High Wall Duct-Free High Efficiency Single Zone



**18,000 BTUs**

**LS181HSV2 (H/P Model)**

**C** 18,200 BTUs Cooling

**H** 22,000 BTUs Heating



**FEATURES:**

- Inverter (Variable speed compressor)
- Energy saving
- R-410A refrigerant
- Gold Fin™ anti-corrosion
- Self-cleaning indoor coil
- Cooling/Heating/Fan mode
- Jet cool/Jet heat
- Chaos wind
- 4-Way auto swing
- Ultra quiet operation

- Sleep mode
- Dehumidifying mode
- Auto restart
- Auto changeover
- Built-in low ambient standard, down to 14°F (Cooling mode)
- 24-Hour on/off timer
- Condensate sensor connection
- Plasma air purifying system

**Interior Unit Includes:**

- Wall unit
- Installation plate & hardware
- Remote control, batteries, holder & holder hardware
- Installation manual
- Optional accessories
  - Model#:PQRCVSL0(QW) (Wired wall thermostat)
  - Model#:ZLABGP02A (Low ambient wind baffle kit - cooling down to 0°F)

- Model#: PMNFP14A0 (PI485 V-net interface)

**Exterior Unit Includes:**

- Exterior unit
- Exterior unit has sufficient refrigerant for charging indoor coil and a 25' line set (Line set not included)

ETL# : 3091879

\* Specification can be changed without notification

System Model #	LS181HSV2
Indoor Model #	LSN181HSV2
Outdoor Model #	LSU181HSV2
<b>Performance</b>	
Capacity (BTUs)	<b>C</b> 18,200 <b>H</b> 22,000
EER	12.6
SEER	20.5
HSPF	9.7
Air Circulation (CFM H/M/L)	600/510/420
Fan Speeds	6/Auto/Chaos
Dehumidification (pts/hr)	5.5
Indoor dB(A)*	45/40/35
Outdoor dB(A)*	53
<b>Electrical</b>	
Rated Voltage Outdoor	230/208-60-1
Rated Voltage Indoor	230/208-60-1
<b>Indoor Dimensions</b>	
W x H x D (inches)	40 9/16 x 12 13/16 x 9 7/8
Weight (lbs.)	30.9
<b>Outdoor Dimensions</b>	
W x H x D (inches)	34 5/16 x 31 1/2 x 12 5/8
Weight (lbs.)	132.3
<b>Thermostat Range</b>	
Cooling / Heating (°F)	64-86/60-86

\*LG verified sound ratings

Warranty: 2 years parts; 5 years compressor.

Product



# High Wall Duct-Free High Efficiency Single Zone



**24,000 BTUs**

**LS240HSV2 (H/P Model)**

**C** 22,000 BTUs Cooling

**H** 27,600 BTUs Heating



**INVERTER V**



**FEATURES:**

- Inverter (Variable speed compressor)
- Energy saving
- R-410A refrigerant
- Gold Fin™ anti-corrosion
- Self-cleaning indoor coil
- Cooling/Heating/Fan mode
- Jet cool/Jet heat
- Chaos wind
- 4-Way auto swing
- Sleep mode
- Dehumidifying mode
- Auto restart
- Auto changeover
- Built-in low ambient standard, down to 14°F (Cooling mode)
- 24-Hour on/off timer
- Condensate sensor connection
- Plasma air purifying system

**Interior Unit Includes:**

- Wall unit
- Installation plate & hardware
- Remote control, batteries, holder & holder hardware
- Installation manual
- Optional accessories
  - Model#:PQRCVSL0(QW) (Wired wall thermostat)
  - Model#:ZLABGP02A (Low ambient wind baffle kit - cooling down to 0°F)

- Model#: PMNFP14A0 (PI485 V-net interface)

**Exterior Unit Includes:**

- Exterior unit
  - Exterior unit has sufficient refrigerant for charging indoor coil and a 25' line set (Line set not included)
- ETL# : 3091879

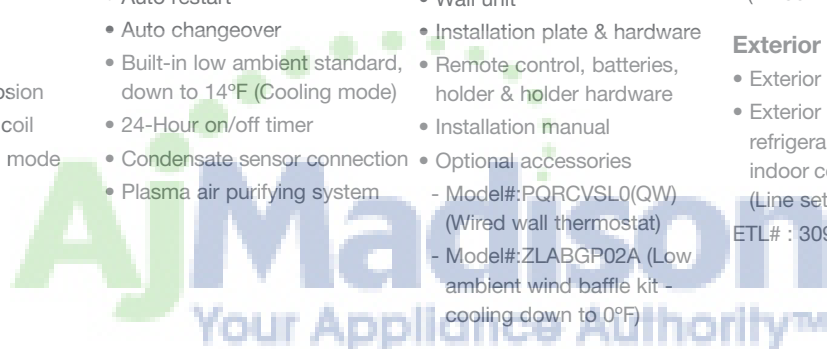

\* Specification can be changed without notification

System Model #	LS240HSV2
Indoor Model #	LSN240HSV2
Outdoor Model #	LSU240HSV2
<b>Performance</b>	
Capacity (BTUs)	<b>C</b> 22,000 <b>H</b> 27,600
EER	12.5
SEER	18.9
HSPF	10.2
Air Circulation (CFM H/M/L)	700/570/450
Fan Speeds	4/Auto/Chaos
Dehumidification (pts/hr)	6.0
Indoor dB(A)*	46/43/39
Outdoor dB(A)*	54
<b>Electrical</b>	
Rated Voltage Outdoor	230/208-60-1
Rated Voltage Indoor	230/208-60-1
<b>Indoor Dimensions</b>	
W x H x D (inches)	47 5/8 x 13 5/8 x 8 1/16
Weight (lbs.)	33.1
<b>Outdoor Dimensions</b>	
W x H x D (inches)	34 5/16 x 31 1/2 x 12 5/8
Weight (lbs.)	141.1
<b>Thermostat Range</b>	
Cooling / Heating (°F)	64-86/60-86

\*LG verified sound ratings

Warranty: 2 years parts; 5 years compressor.

Product

# High Efficiency Single Zone Inverter Electrical & Refrigeration Quick Reference

Electrical Specifications								
Zone	Type	Model	BTUs	Voltage		Rated Amps	MCA*	MOP**
				Indoor	Outdoor			
High Efficiency Art Cool™ Mirror Single Zone	H/P	C H LA090HSV2	9,000	230/208	230/208	8.5	10	15
	H/P	C H LA120HSV2	11,200	230/208	230/208	8.5	10	15
	H/P	C H LA180HSV2	18,200	230/208	230/208	17.0	19	30
	H/P	C H LA240HSV2	22,000	230/208	230/208	17.0	19	30
High Efficiency Single Zone	H/P	C H LS091HSV2	9,000	230/208	230/208	8.1	10	15
	H/P	C H LS121HSV2	11,200	230/208	230/208	8.1	10	15
	H/P	C H LS181HSV2	18,200	230/208	230/208	15.4	19	30
	H/P	C H LS240HSV2	22,000	230/208	230/208	15.4	19	30

\*Minimum Circuit Ampacity

\*\*Maximum Overcurrent Protection

All equipment single phase.

NOTE: Please see local electrical codes for proper wire specifications.

Refrigerant Line Specifications***								
Zone	Type	Model	BTUs	Pipe Size		Additional Refrigerant	Max. Pipe Length	Max. Elevation
				Liquid	Suction			
High Efficiency Art Cool™ Mirror Single Zone	H/P	C H LA090HSV2	9,000	1/4"	3/8"	0.22 oz./ft.	65'	32'
	H/P	C H LA120HSV2	11,200	1/4"	3/8"	0.22 oz./ft.	65'	32'
	H/P	C H LA180HSV2	18,200	3/8"	5/8"	0.38 oz./ft.	98'	49'
	H/P	C H LA240HSV2	22,000	3/8"	5/8"	0.38 oz./ft.	98'	49'
High Efficiency Single Zone	H/P	C H LS091HSV2	9,000	1/4"	3/8"	0.22 oz./ft.	65'	32'
	H/P	C H LS121HSV2	11,200	1/4"	3/8"	0.22 oz./ft.	65'	32'
	H/P	C H LS181HSV2	18,200	3/8"	5/8"	0.38 oz./ft.	98'	49'
	H/P	C H LS240HSV2	22,000	3/8"	5/8"	0.38 oz./ft.	98'	49'

Please choose a proper wire size based on local and state code

\*\*\*Each system is pre-charged with enough refrigerant to charge 25 ft. (41 ft. for LA090HSV2, LA120HSV2, LS091HSV2, LS121HSV2) of line and the interior unit.

## Accessory

Wired Wall Thermostat for Single Zone Inverter.  
(Applicable to LS307HV2, LS360HV2, LXXXXHSV2 and LSXXXXHVY models only)



PQRCVSL0



PQRCVSL0QW

# High Wall Duct-Free Standard Single Zone

## Customized Good Looks

Standard High Wall heat pump systems utilize the same duct-free technology as Art Cool™ units in a streamlined, low profile design. Models are available in a variety of sizes from 9,000 through 36,000 BTUs. LG's standard duct-free air conditioners are easy to install and cost effective.

**Available Styles**

Standard Indoor Unit  
White  
9,000-18,000 BTUs

**INVERTER V**

Inverter Indoor Unit  
White  
30,000-36,000 BTUs

Indoor Unit

Outdoor Unit

**36V DC**  
INDOOR UNIT  
CREATION\*

\*9,000 - 18,000  
BTUs units only

**AjMadison**  
Your Appliance Authority™  
800-570-3355

# High Wall Duct-Free Standard Single Zone

**9,000 BTUs  
12,000 BTUs**

**LS093HE (H/P Model)**

- 10,500 BTUs Cooling
- 10,500 BTUs Heating

**LS122HE (H/P Model)**

- 11,500 BTUs Cooling
- 11,500 BTUs Heating



## FEATURES:

- R-410A refrigerant
- Gold Fin™ anti-corrosion
- Dehumidifying mode
- Chaos wind
- Jet Cool
- Cooling mode
- Heating mode
- Fan mode
- Auto operation
- Manual power switch
- Defrost control

- Temperature display on indoor unit
- Auto sleep mode
- Auto restart
- Built-in low ambient standard, down to 14°F (Cooling mode)
- 24-Hour on/off timer
- 4 Fan speeds
- Plasma air purifying system
- Ultra-quiet operation
- Evaporator frost control

**Interior Unit Includes:**

- Wall unit
- Installation plate & hardware
- Remote control, batteries, holder & holder hardware
- Installation manual

**Exterior Unit Includes:**

- Exterior unit
- Exterior unit has sufficient refrigerant for charging indoor coil and a 25' line set (Line set not included)

ETL# : 3091879

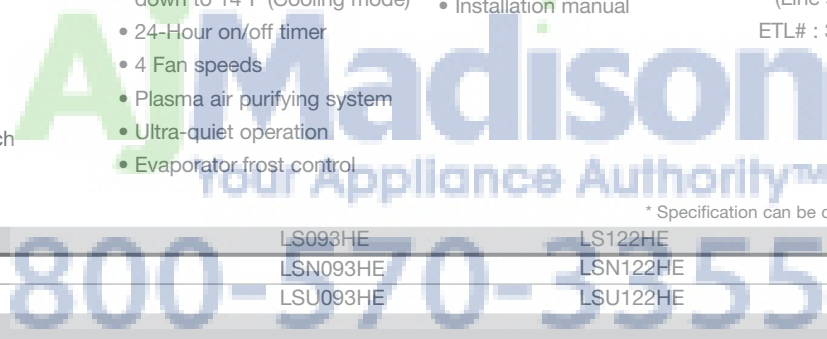

\* Specification can be changed without notification

System Model #	LS093HE	LS122HE
Indoor Model #	LSN093HE	LSN122HE
Outdoor Model #	LSU093HE	LSU122HE
<b>Performance</b>		
Capacity (BTUs)	● 10,500 ● 10,500	● 11,500 ● 11,500
EER	9.5	10
SEER	13	13
HSPF	7.8	7.8
Air Circulation (CFM H/M/L)	330/280/230	330/280/230
Fan Speeds	4/Auto/Chaos	4/Auto/Chaos
Dehumidification (pts/hr)	3.0	3.0
Indoor dB(A)*	41/36/34	41/36/34
Outdoor dB(A)*	48	48
<b>Electrical</b>		
Rated Voltage Outdoor	115-60-1	115-60-1
Rated Voltage Indoor	36V DC	36V DC
<b>Indoor Dimensions</b>		
W x H x D (inches)	35 1/4 x 11 1/8 x 6 1/2	35 1/4 x 11 1/8 x 6 1/2
Weight (lbs.)	20.5	20.5
<b>Outdoor Dimensions</b>		
W x H x D (inches)	30 5/16 x 21 5/16 x 9 5/8	30 5/16 x 21 5/16 x 9 5/8
Weight (lbs.)	72.8	72.8
<b>Thermostat Range</b>		
Cooling / Heating (°F)	64-86/60-86	64-86/60-86

\*LG verified sound ratings

Warranty: 2 years parts; 5 years compressor.

Product

# High Wall Duct-Free Standard Single Zone

**18,000 BTUs**

## LS186HE (H/P Model)

● 17,800 BTUs Cooling

● 17,800 BTUs Heating



## FEATURES:

- Multi Power System™
- R-410A refrigerant
- Gold Fin™ anti-corrosion
- Dehumidifying mode
- Chaos wind
- Jet cool
- Cooling mode
- Heating mode
- Fan mode
- Auto operation

- Manual power switch
- Defrost control
- Temperature display on indoor unit
- Auto sleep mode
- Auto restart
- 24-Hour on/off timer
- Ultra-quiet operation
- Plasma air purifying system
- Evaporator frost control
- 4 Fan speeds

### Interior Unit Includes:

- Wall unit
- Installation plate & hardware
- Remote control, batteries, holder & holder hardware
- Installation manual

### Exterior Unit Includes:

- Exterior unit
- Exterior unit has sufficient refrigerant for charging indoor coil and a 25' line set (Line set not included)

ETL# : 3091879

**AIMadison**  
Your Appliance Authority™

\* Specification can be changed without notification

System Model #	LS186HE
Indoor Model #	LSN186HE
Outdoor Model #	LSU186HE
<b>Performance</b>	
Capacity (BTUs)	● 17,800 ● 17,800
EER	8.9
SEER	13
HSPF	7.7
Air Circulation (CFM H/M/L)	560/490/430
Fan Speeds	4/Auto/Chaos
Dehumidification (pts/hr)	5.3
Indoor dB(A)*	46/43/41
Outdoor dB(A)*	53
<b>Electrical</b>	
Rated Voltage Outdoor	230/208-60-1
Rated Voltage Indoor	36V DC
<b>Indoor Dimensions</b>	
W x H x D (inches)	42 15/16 x 11 13/16 x 7 1/32
Weight (lbs.)	28.6
<b>Outdoor Dimensions</b>	
W x H x D (inches)	34 5/16 x 25 13/16 x 12 5/8
Weight (lbs.)	124.3
<b>Thermostat Range</b>	
Cooling / Heating (°F)	64-86/60-86

\*LG verified sound ratings

Warranty: 2 years parts; 5 years compressor.

# High Wall Duct-Free Inverter Standard Single Zone



**INVERTER V**



**30,000 BTUs / 36,000 BTUs**

**LS307HV2 (H/P Model)**

- 30,000 BTUs Cooling
- 32,000 BTUs Heating

**LS360HV2 (H/P Model)**

- 33,000 BTUs Cooling
- 35,200 BTUs Heating

**FEATURES:**

- Inverter (Variable speed compressor)
- R-410A refrigerant
- Gold Fin™ anti-corrosion
- Chaos swing
- Self-cleaning indoor coil
- Auto changeover
- Jet cool
- Cooling/Heating/Fan Mode
- Auto sleep mode
- Ultra-quiet operation
- Dehumidifying mode
- Auto restart
- 24-Hour on/off timer
- Built-in low ambient standard, down to 14°F (Cooling mode)
- Manual power switch
- Defrost control
- Temperature display on indoor unit
- Evaporator frost control
- Energy saving
- 4 Fan speeds
- Plasma air purifying system
- Condensate sensor connection

**Interior Unit Includes:**

- Wall unit
- Installation plate & hardware
- Remote control, batteries, holder & holder hardware
- Installation manual
- Optional accessories
  - Model#:PQRCVSL0(QW) (Wired wall thermostat)
  - Model#:ZLABGP02A (Low ambient wind baffle kit - cooling down to 0°F)

- Model#: PMNFP14A0 (PI485 V-net interface - LS360HV2 only)

**Exterior Unit Includes:**

- Exterior unit
  - Exterior unit has sufficient refrigerant for charging indoor coil and a 25' line set (Line set not included)
- ETL# : 3091879

\*Specification can be changed without notification

System Model #	LS307HV2	LS360HV2
Indoor Model #	LSN307HV2	LSN360HV2
Outdoor Model #	LSU307HV2	LSU360HV2
<b>Performance</b>		
Capacity (BTUs)	● 30,000 ● 32,000	● 33,000 ● 35,200
EER	10.0	8.2
SEER	18.0	16.1
HSPF	9.5	9.9
Air Circulation (CFM H/M/L)	730/670/450	740/670/450
Fan Speeds	4/Auto/Chaos	4/Auto/Chaos
Dehumidification (pts/hr)	9.5	10.6
Indoor dB(A)*	49/44/39	49/44/39
Outdoor dB(A)*	55	55
<b>Electrical</b>		
Rated Voltage Outdoor	230/208-60-1	230/208-60-1
Rated Voltage Indoor	230/208-60-1	230/208-60-1
<b>Indoor Dimensions</b>		
W x H x D (inches)	47 5/8 x 13 5/8 x 8 1/16	47 5/8 x 13 5/8 x 8 1/16
Weight (lbs.)	33.1	33.1
<b>Outdoor Dimensions</b>		
W x H x D (inches)	34 5/16 x 31 1/2 x 12 5/8	34 5/16 x 31 1/2 x 12 5/8
Weight (lbs.)	141.1	141.1
<b>Thermostat Range</b>		
Cooling / Heating (°F)	64-86 /60-86	64-86 /60-86

\*LG verified sound ratings

Warranty: 2 years parts; 5 years compressor.

Product

800-370-3355

Air Conditioner  
Your Appliance Authority™

# Standard & Inverter Standard Single Zone Electrical & Refrigeration Quick Reference

Electrical Specifications									
Zone	Type		System Model	BTUs	Voltage		Rated Amps	MCA*	MOP**
					Indoor	Outdoor			
Standard Single Zone	H/P	C H	LS093HE	9,800	36V DC	115	10.5	14.3	20
	H/P	C H	LS122HE	11,500	36V DC	115	10.5	14.3	20
	H/P	C H	LS186HE	17,800	36V DC	230/208	10.4	14.2	20
Inverter Standard Single Zone	H/P	C H	LS307HV2	30,000	230/208	230/208	17.8	16.8	25
	H/P	C H	LS360HV2	33,000	230/208	230/208	17.8	16.8	25

\*Minimum Circuit Ampacity \*\*Maximum Overcurrent Protection

Refrigerant Line & Formula Specifications†									
Zone	Type		System Model	BTUs	Pipe Size		Additional Refrigerant	Max. length each pipe	Max. elevation
					Liquid	Suction			
Standard Single Zone	H/P	C H	LS093HE	9,800	1/4"	1/2"	0.22 oz./ft.	49'	23'
	H/P	C H	LS122HE	11,500	1/4"	1/2"	0.22 oz./ft.	49'	23'
	H/P	C H	LS186HE	17,800	1/4"	1/2"	0.22 oz./ft.	66'	23'
Inverter Standard Single Zone	H/P	C H	LS307HV2	30,000	3/8"	5/8"	0.38 oz./ft.	98'	49'
	H/P	C H	LS360HV2	33,000	3/8"	5/8"	0.38 oz./ft.	98'	49'

† Each system is pre-charged with enough refrigerant to charge 25 ft. of line and the interior unit.

All equipment single phase.  
NOTE: Please see local electrical codes for proper wire specifications.

Wire Size	
Minimum wiring requirements suggested by manufacturer.	
Minimum AWG	14-3 12-3***
Indoor/Outdoor Connecting Cable Minimum AWG	18-4

\*\*\*For LS186HE

# Duct-Free Air Conditioners

## LG Internet Sales Policy

### Duct-Free Air Conditioning Products

LG's expressed Duct-Free Air Conditioning warranty policy applies only to products sold and installed by qualified air conditioning contractors.

Because products sold via the Internet cannot be assured of quality installation by a qualified air conditioning contractor, LG's expressed warranty may not apply to internet sales.

LG supports and recommends that a qualified air conditioning contractor properly size and install all LG Duct-Free Air Conditioning products for optimal performance and long life.

## For The HVAC Professional

### Installation • Materials

#### Don't forget to BUY...

- Mounting screws and anchors (wall mount and ceiling cassette)
- Optional condensate pump (interior wall installation only)
- Optional condensate sensor
- Condensate drain tubing
- Hose clamps
- Refrigerant line
- Correct electrical wire to connect indoor and outdoor units based on the LG model chosen (see electrical specifications) and local electrical code requirements

- Closed cell insulating tubing for liquid and suction lines
- Electrical tape
- Condenser mounting pad
- Disconnect and wiring for condenser unit
- Plastic duct and installation hardware to conceal connecting tubing on exterior walls

#### Don't forget to BRING...

- Level gauge
- 2 3/4" hole core drill
- Flaring tool set
- Gas leak detector
- Vacuum pump
- Gauge manifold
- Micron gauge
- R-410A service port adapter

## Remember These

### Other Installation Items to Consider



Low Voltage Condensate Pump  
24V Condensate Pumps available from Aspen Pumps by calling 732-248-8066\*

Low Ambient Wind Baffle Kit  
Part # ZLABGP01A (LS091-121HSV2)  
Part # ZLABGP02A (LS181-240HSV2, LS307HV2, LS360HV2)



AquaGuard Condensate Sensor Part # AG-9300-LG



Wired Wall Thermostat for Duct-Free Systems  
Part # PQRCVSL0(QW)  
Applicable to inverter models only (LS307HV2, LS360HV2, LXXXXHSV2 and LSXXXXHV)

\*LG is not responsible for improper installation.

# Ceiling Cassette Duct-Free Single Zone

Ceiling Cassette models are ideal for light commercial applications and work well in large, open spaces. The ceiling cassette is a useful alternative when wall space is limited.



Duct-Free Split  
Ceiling Cassette Indoor Units  
White Finish

**AjMadison**  
Your Appliance Authority  
800-570-3355

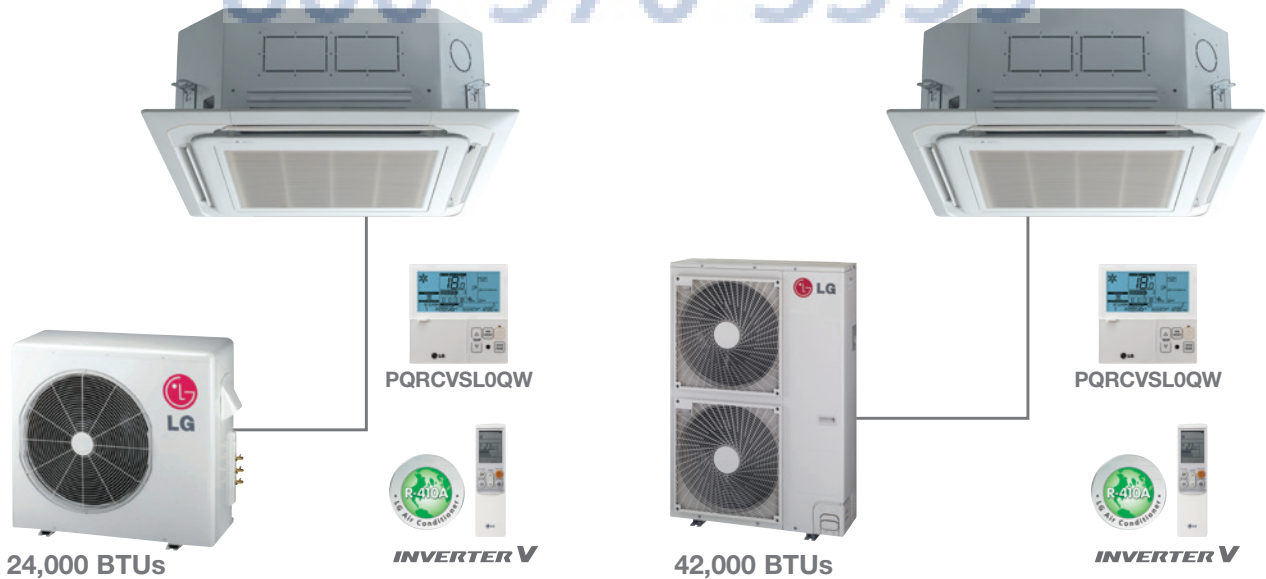

Single Zone Split Systems  
Ceiling Cassette

Product

# Ceiling Cassette Duct-Free Single Zone

24,000 BTUs

**LC246HV (H/P Model)**

Ⓒ 23,000 BTUs Cooling

Ⓗ 25,000 BTUs Heating



**INVERTER V**



42,000 BTUs

**LC426HV (H/P Model)**

Ⓒ 41,000 BTUs Cooling

Ⓗ 41,000 BTUs Heating



**INVERTER V**



## FEATURES:

- Inverter (Variable speed compressor)
- R-410A refrigerant
- Internal condensate pump included
- Swirl wind
- 4-Way cooling
- Jet cool
- Cooling mode
- Dehumidifying mode
- Plasma air purifying system

- Built-in low ambient standard, down to 14°F (Cooling mode)
- Fan mode
- Independent vane control
- 5 Fan speeds
- Evaporator frost control
- 24-Hour on/off timer
- Auto restart
- Auto changeover
- Temperature display on remote
- Ultra-quiet turbo fan
- Gold Fin™ anti-corrosion

### Interior Unit Includes:

- Ceiling unit
- Wired control & wireless remote control with batteries
- Installation manual
- Required accessory
  - Model name : PT-UMC (Ceiling grill sold separately)
- Optional accessories
  - Model#:PQRCVSL0(QW) (Wired wall thermostat)

- Model name : PTPKM0 (Plasma kit)

- Model#: PMNFP14A0 (PI485 V-net interface - LC426HV only)

### Exterior Unit Includes:

- Sufficient refrigerant for charging indoor coil and a 25' line set (Line set not included)
- ETL# : 3091879

\* Specification can be changed without notification

System Model #	LC246HV	LC426HV
Indoor Model #	LCN246HV	LCN426HV
Outdoor Model #	LUU246HV	LUU426HV
Ceiling Grill Model# (Sold Separately)	PT-UMC	PT-UMC
<b>Performance</b>		
Capacity (BTUs)	Ⓒ 23,000 Ⓗ 25,000	Ⓒ 41,000 Ⓗ 41,000
SEER	14	14
HSPF	7.7	7.7
EER	9.2/9.8	8.8/8.9
Air Circulation (CFM H/M/L)	636/565/494	1,200/1,130/1,060
Fan Speeds (Fan/Cooling/Heating)	4/5/4	4/5/4
Dehumidification (pts/hr)	2.1	3.6
Indoor dB(A)*	39/37/34	46/44/40
Outdoor dB(A)*	55	58
<b>Electrical</b>		
Rated Voltage Outdoor	230/208-60-1	230/208-60-1
Rated Voltage Indoor	230/208-60-1	230/208-60-1
Power Input (Cooling/Heating)	2,500/2,550	4,670/4,630
Max Power Input	3,800	5,700
<b>Indoor Dimensions</b>		
W x H x D (inch)	33 1/16 x 8 1/32 x 33 1/16	33 1/16 x 11 11/32 x 33 1/16
Weight (lbs.)	46.3	57.3
<b>Outdoor Dimensions</b>		
W x H x D (inch)	34 1/4 x 31 13/16 x 12 19/32	37 13/32 x 54 11/32 x 13
Weight (lbs.)	132.0	227.0
<b>Thermostat Range</b>		
Cooling (°F)	64-86	64-86
Heating (°F)	60-86	60-86

\*LG verified sound ratings

Warranty: 2 years parts; 5 years compressor.

Product

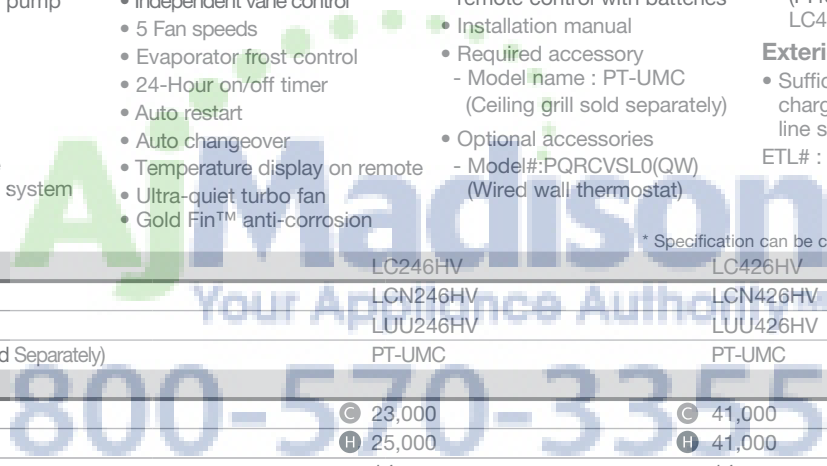

# Ceiling Cassette Single Zone Electrical & Refrigeration Quick Reference

Electrical Specifications								
	Type	System #	BTUs	Voltage		Rated Amps	MCA*	MOP**
				Indoor	Outdoor			
Ceiling Cassette	H/P	LC246HV	23,000	230/208	230/208	16.1	17.6	25.0
	H/P	LC426HV	41,000	230/208	230/208	25.3	22.3	40.0

All equipment single phase.

\*Minimum Circuit Ampacity  
\*\*Maximum Overcurrent Protection

NOTE: Please see local electrical codes for proper wire specifications.

Electrical Specifications								
	Type	System #	BTUs	Pipe Size		Additional Refrigerant	Max. length each pipe	Max. elevation
				Liquid	Suction			
Ceiling Cassette	H/P	LC246HV	23,000	3/8"	5/8"	0.38 oz./ft.	98'	66'
	H/P	LC426HV	41,000	3/8"	5/8"	0.43 oz./ft.	164'	98'

†Each system is pre-charged with enough refrigerant to charge 25 ft. of line and the interior unit.

## Controls Accessories

Wired Controllers and V-net Integration Board



PQRCVSLO



PQRCVSLOQW



PQRCVCLOQ



PQRCVCLOQW

Applied to LS---HYV, LA---HSV2, LS---HSV2, LS---HV2 & LC---HV indoor units

PI485 V-net control integration accessory  
Control integration to LG V-net controls  
(AC Smart, ACP, BACnet, LonWorks, etc.)

Applied to LS---HYV, LA180/240HSV2, LS181/240HSV2,  
LS360HV2 & LC426HV outdoor units



PMNFP14A0

# Flex Multi Dual-, Tri- & Quad-Zone Air Conditioning Systems

## Flex Multi Systems

The larger, Flex Multi inverter heat pump systems operate two, three or four interior units that are typically mounted in separate rooms. Each indoor unit comes with its own remote control, allowing the customer to set the temperature individually in different rooms. These units are connected to a single exterior unit.

The interior units are available in a variety of styles, including Art Cool™, Standard, Ceiling Cassette, and Ceiling Concealed Duct models.

### Available Styles



Flex Multi Art Cool™ Indoor Unit Mirror Finish



Flex Multi Standard Indoor Unit



Flex Multi Ceiling Cassette & Ceiling Concealed Duct

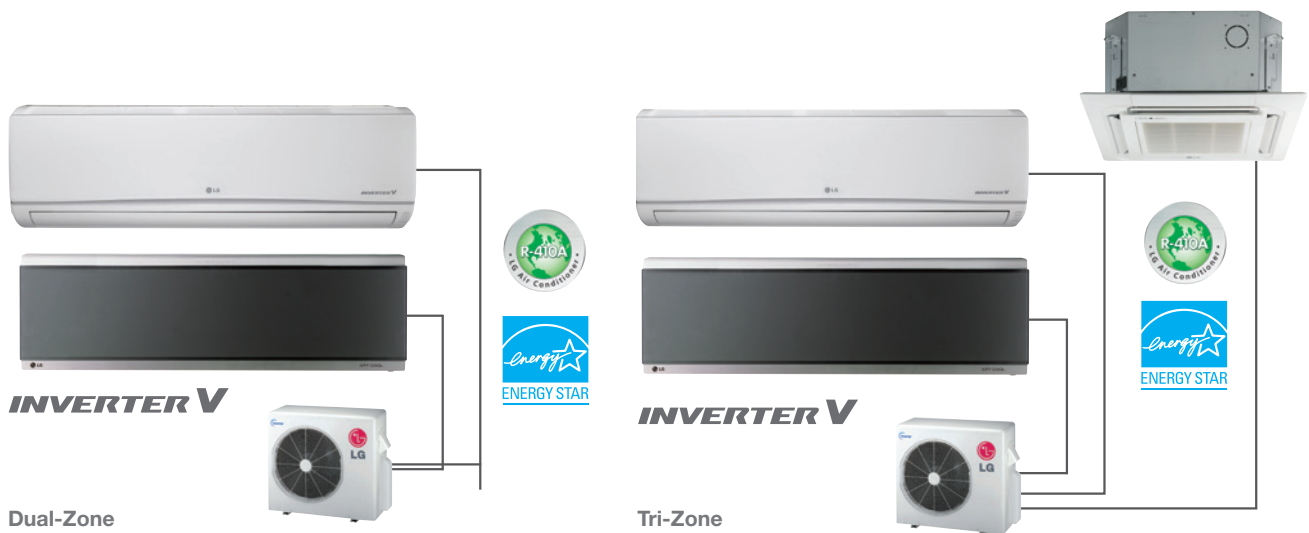

**Dual-Zone**  
Flex Mult System  
Mix and match for 18,000-24,000 BTUs  
Heat Pump Inverter

**Tri-Zone**  
Flex Multi System  
Mix and match for 27,000-33,000 BTUs  
Heat Pump Inverter



**Quad-Zone**  
 Flex Multi System  
 Mix and match for 36,000-48,000 BTUs  
 Heat Pump Inverter



Product

# Why LG Multi-Zone?

Energy Saving  
with LG inverter Technology

Wide Choice of Indoor Units:  
Standard, Art Cool™, Concealed Duct,  
Cassette Types

Design Flexibility:  
Outdoor units connect to several  
indoor unit styles

800-570-3355

Flex Multi Inverter Heat Pump Outdoor Units



DUAL-ZONE  
LMU187HV



TRI-ZONE  
LMU247HV



QUAD-ZONE  
LMU369HV



# Flex Multi Inverter Heat Pump Outdoor Units

18,000-36,000 BTUs

**LMU187HV**  
 Dual-Zone

**LMU369HV**  
 Quad-Zone

**LMU247HV**  
 Tri-Zone



DUAL-ZONE  
LMU187HV

TRI-ZONE  
LMU247HV

QUAD-ZONE  
LMU369HV

## FEATURES:

- Defrost/Deicing
- Restart delay (3-minutes)
- Self diagnosis
- Soft start
- Inverter (Variable speed compressor)
- Auto operation
- Auto restart operation
- Low ambient operation to 14°F (Cooling mode)
- Gold Fin™ anti-corrosion
- Sufficient refrigerant for charging 2, 3 or 4 indoor coils (Please see chart below for actual length amount included)
- Installation manual  
ETL# : 3091879

### Exterior Unit Includes:

- Exterior unit

\* Specification can be changed without notification

Outdoor Model H/P Inverter #			LMU187HV	LMU247HV	LMU369HV
Capacity *		BTU/h	18,000 Class	24,000 Class	34,000 Class
Power Input	Cooling	kW	0.26~1.12~2.37	0.39~1.43~3.09	0.77~2.72~3.92
	Heating	kW	0.28~1.29~2.48	0.42~2.21~3.10	1.12~3.58~4.10
Running Current	Cooling	A	1.5~5.2~10.8	2.8~6.6~14.0	3.3~11.8~17.0
	Heating	A	1.5~6.0~11.3	3.0~10.2~14.1	4.9~15.5~17.8
Power Supply		Ø / V / Hz	1/208~230/60	1/208~230/60	1/208~230/60
Power Supply Cable(Outdoor)		No. x AWG	3 x 14	3 x 12	3 x 12
Transmission Cable					
(Outdoor to Indoor unit)		No. x AWG	4 x 18	4 x 18	4 x 18
Dimensions (W x H x D)		inch	34 1/4 x 31	34 1/4 x 31	35 7/16 x 45
			13/16 x 12 19/32	13/16 x 12 19/32	7/8 x 14 9/16
Net Weight		lbs	123.5	130.1	209.4
Max. # of Connectable					
Indoor Units			2	3	4
Refrigerant	Charge (at 24.6 ft.)	oz	67.0	74.1	123.5
	Type		R-410A	R-410A	R-410A
	Control		EEV	EEV	EEV
Sound Level (H)	Sound Pressure	dB(A) <sup>6</sup>	51	51	57
Piping Connections	Liquid	in.	1/4 x 2EA	1/4 x 3EA	1/4 x 4EA
	Gas	in.	3/8 x 2EA	3/8 x 3EA	3/8 x 4EA
Piping length spec.	Max. total piping	ft.	164.0	246.1	246.1
	Max. OD-ID piping	ft.	82.0	82.0	82.0
	Piping length(no add'l refrig)	ft.	49.2	73.8	98.4
Max. Elevation Difference	Outdoor Unit~Indoor Unit	ft.	49.2	49.2	49.2
	Indoor Unit~Indoor Unit	ft.	24.6	24.6	24.6
Operation Range	Cooling	°F	14 ~ 114.8	14 ~ 114.8	14 ~ 114.8
	Heating	°F	5 ~ 75.2	5 ~ 75.2	5 ~ 75.2

Note :

- Capacities are based on the following conditions:  
 Cooling: - Indoor Temperature 80°F (26.7°C) DB/67°F (19.4°C) WB  
 - Outdoor Temperature 95°F (35°C) DB/75°F (23.9°C) WB  
 Heating: - Indoor Temperature 70°F (21.1°C) DB/60°F (15.6°C) WB  
 - Outdoor Temperature 47°F (8.3°C) DB/43°F (6.1°C) WB  
 Piping Length: - Interconnecting Piping Length 24.6 ft.(7.5m)  
 - Level Difference of Zero

- Wiring cable size must comply with applicable local and national codes.
- The specification may be subject to change without prior notice for purpose of improvement.
- For more capacity(\*) information, refer to the combination tables.
- The data mentioned in the above table is only for non-ducted type indoor units.
- LG verified sound ratings.

Warranty: 2 years parts; 5 years compressor.

# Flex Multi Standard Wall Mount Indoor Units



**INVERTER V**



**9,000-18,000 BTUs**

**LMN096HVT (H/P Model)**

**LMN126HVT (H/P Model)**

**LMN186HVT (H/P Model)**

## FEATURES:

- Inverter (Variable speed fan)
  - Chaos wind
  - Jet cool/Jet heat
  - Self-cleaning indoor coil
  - Auto operation (Artificial intelligence)
  - Auto restart operation
  - 24-Hour on/off timer
  - 4-Way auto swing
  - Sleep mode
  - Plasma air purifying system
  - Wireless LCD remote control, batteries, holder & holder hardware
  - Owner's manual
  - Wired thermostat available, sold separately
- Interior Unit Includes:**
- Wall unit
  - Installation plate & hardware
- ETL# : 3091879

\* Specification can be changed without notification

Indoor Model H/P Inverter #	LMN096HVT	LMN126HVT	LMN186HVT
<b>Performance</b>			
Capacity* (BTU/h)	9,000 Class	12,000 Class	18,000 Class
Fan Air Flow Rate (CMM)	7.0/6.5/6.0	9.5/9.0/8.5	16.2/14.2/12.3
(H/M/L) (CFM)	247/230/212	336/318/300	572/502/434
Dehumidification Rate (pts/hr)	2.3	2.5	4.0
Sound Level H/M/L (dB(A)*)	33/30/27	39/36/31	37/33/28
<b>Electrical</b>			
Running Current (A)	0.20	0.20	0.30
Power Supply (Ø/V/Hz)	1/208~230/60	1/208~230/60	1/208~230/60
<b>Piping Connections</b>			
Liquid (inches)	1/4	1/4	1/4
Gas (inches)	3/8	3/8	1/2
Temperature Sensor	Thermistor	Thermistor	Thermistor
Refrigerant	R-410A	R-410A	R-410A
Power/Transmission Interunit Cable (No. x AWG)	4 x 18	4 x 18	4 x 18
<b>Dimensions (WxHxD)</b>			
Body (inches)	35 1/4 x 11 7/32 x 8 9/32	35 1/4 x 11 7/32 x 8 9/32	40 9/16 x 12 25/32 x 9 27/32
Decorative Panel (inches)	-	-	-
Net Weight Body (lbs)	22.1	22.1	32.0
Net Weight Decorative Panel (lbs)	-	-	-

Note :

\*LG verified sounds ratings

1. Capacities are based on the following conditions:

- Cooling: - Indoor Temperature 80°F (26.7°C) DB/67°F (19.4°C) WB
- Outdoor Temperature 95°F (35°C) DB/75°F (23.9°C) WB
- Heating: - Indoor Temperature 70°F (21.1°C) DB/60°F (15.6°C) WB
- Outdoor Temperature 47°F (8.3°C) DB/43°F (6.1°C) WB
- Piping Length: - Interconnecting Piping Length 24.6 ft.(7.5m)
- Level Difference of Zero

2. Wiring cable size must comply with applicable local and national codes.

3. The specification may be subject to change without prior notice for purpose of improvement.

4. For more capacity(\*) information, refer to the combination tables.

Warranty: 2 years parts; 5 years compressor.

# Flex Multi Art Cool™ Wall Mount Indoor Units



**9,000-18,000 BTUs**

**LMAN095HVT (H/P Model)**  
**LMAN125HVT (H/P Model)**  
**LMAN185HVT (H/P Model)**

**INVERTER V**



## FEATURES:

- Inverter (Variable speed fan)
  - Chaos swing
  - Jet cool
  - Self-cleaning indoor coil
  - Auto operation (Artificial intelligence)
  - Auto restart operation
  - 24-Hour on/off timer
  - Plasma air purifying system
- Interior Unit Includes:**
- Wall unit
  - Installation plate & hardware
  - Wireless LCD remote control, batteries, holder & holder hardware
  - Owner's manual
- Wired thermostat available, sold separately
- ETL# : 3091879

\* Specification can be changed without notification

Indoor Model H/P Inverter #	LMAN095HVT	LMAN125HVT	LMAN185HVT
<b>Performance</b>			
Capacity* (BTU/h)	9,000 Class	12,000 Class	18,000 Class
Fan Air Flow Rate (CMM)	8.0/7.0/5.0	10.0/8.0/6.0	12.6/11.5/10.0
(H/M/L) (CFM)	283/247/177	353/283/212	445/406/353
Dehumidification Rate (pts/hr)	2.5	3.2	4.2
Sound Level H/M/L (dB(A)*)	31/26/22	35/28/24	39/37/35
<b>Electrical</b>			
Running Current (A)	0.15	0.15	0.15
Power Supply (Ø/V/Hz)	1/208~230/60	1/208~230/60	1/208~230/60
<b>Piping Connections</b>			
Liquid (inches)	1/4	1/4	1/4
Gas (inches)	3/8	3/8	1/2
Temperature Sensor	Thermistor	Thermistor	Thermistor
Refrigerant	R-410A	R-410A	R-410A
Power/Transmission Interunit Cable (No. x AWG)	4 x 18	4 x 18	4 x 18
<b>Dimensions (WxHxD)</b>			
Body (inches)	36 1/32 x 11 3/32 x 6 1/2	36 1/32 x 11 3/32 x 6 1/2	43 19/32 x 11 25/32 x 7 7/8
Decorative Panel (inches)	-	-	-
Net Weight Body (lbs)	20.9	20.9	31.1
Net Weight Decorative Panel (lbs)	-	-	-

Note :

1. Capacities are based on the following conditions:  
Cooling: - Indoor Temperature 80°F (26.7°C) DB/67°F (19.4°C) WB  
- Outdoor Temperature 95°F (35°C) DB/75°F (23.9°C) WB  
Heating: - Indoor Temperature 70°F (21.1°C) DB/60°F (15.6°C) WB  
- Outdoor Temperature 47°F (8.3°C) DB/43°F (6.1°C) WB  
Piping Length: - Interconnecting Piping Length 24.6 ft.(7.5m)  
- Level Difference of Zero

2. Wiring cable size must comply with applicable local and national codes.
3. The specification may be subject to change without prior notice for purpose of improvement.
4. For more capacity(\*) information, refer to the combination tables.

\*LG verified sounds ratings

Warranty: 2 years parts; 5 years compressor.

# Flex Multi Ceiling Concealed Duct Indoor Units



9,000-18,000 BTUs

LMDN095HV (H/P Model)  
LMDN125HV (H/P Model)  
LMDN185HV (H/P Model)

**INVERTER V**



## FEATURES:

- Inverter (Variable speed fan)
- Drain pump
- Control lock function
- Auto operation (Artificial intelligence)
- Auto restart operation
- 2 thermistor control

### Interior Unit Includes:

- Ceiling unit
  - Wired remote control
  - Owner's manual
- ETL# : 3091879

\* Specification can be changed without notification

Indoor Model H/P Inverter #	LMDN095HV	LMDN125HV	LMDN185HV
<b>Performance</b>			
Capacity* (BTU/h)	9,000 Class	12,000 Class	18,000 Class
Fan Air Flow Rate (CMM)	8.5/7.5/6.5	9.5/8.5/7.5	15.0/13.5/11.5
(H/M/L) (CFM)	300/265/230	335/300/265	530/477/406
Dehumidification Rate (pts/hr)	2.1	2.5	4.2
Sound Level H/M/L (dB(A)*)	32/26/25	33/31/26	34/31/29
<b>Electrical</b>			
Running Current (A)	0.25	0.25	0.25
Power Supply (Ø/V/Hz)	1/208~230/60	1/208~230/60	1/208~230/60
<b>Piping Connections</b>			
Liquid (inches)	1/4	1/4	1/4
Gas (inches)	3/8	3/8	1/2
Temperature Sensor	Thermistor	Thermistor	Thermistor
Refrigerant	R-410A	R-410A	R-410A
Power/Transmission Interunit Cable (No. x AWG)	4 x 18	4 x 18	4 x 18
<b>Dimensions (WxHxD)</b>			
Body (inches)	32 9/32 x 7 15/32 x 22 5/8	32 9/32 x 7 15/32 x 22 5/8	43 5/16 x 7 15/32 x 22 5/8
Decorative Panel (inches)	-	-	-
Net Weight Body (lbs)	45.2	45.2	58.4
Net Weight Decorative Panel (lbs)	-	-	-

Note :

- Capacities are based on the following conditions:  
Cooling: - Indoor Temperature 80°F (26.7°C) DB/67°F (19.4°C) WB  
- Outdoor Temperature 95°F (35°C) DB/75°F (23.9°C) WB  
Heating: - Indoor Temperature 70°F (21.1°C) DB/60°F (15.6°C) WB  
- Outdoor Temperature 47°F (8.3°C) DB/43°F (6.1°C) WB  
Piping Length: - Interconnecting Piping Length 24.6 ft.(7.5m)  
- Level Difference of Zero

- Wiring cable size must comply with applicable local and national codes.
- The specification may be subject to change without prior notice for purpose of improvement.
- For more capacity(\*) information, refer to the combination tables.

\*LG verified sounds ratings

Warranty: 2 years parts; 5 years compressor.

# Flex Multi Ceiling Cassette Indoor Units

12,000-18,000 BTUs

LMCN125HV (H/P Model)  
LMCN185HV (H/P Model)



**INVERTER V**



## FEATURES:

- Inverter (Variable speed fan)
  - Drain pump
  - Jet cool
  - Control lock function
  - Auto operation (Artificial intelligence)
  - Auto restart operation
  - 24-Hour on/off timer
  - 2 thermistor control
  - Plasma air purifying system
- Interior Unit Includes:**
- Ceiling unit
  - Wireless LCD remote control, batteries, holder & holder hardware
  - Owner's manual
  - Accessory
- Model name : PT-UQC (Ceiling grill sold separately)
  - Model name : PTPKQ0 (Plasma kit sold separately)
- ETL# : 3091879

\* Specification can be changed without notification

Indoor Model H/P Inverter #	LMCN125HV	LMCN185HV
Ceiling Grill Model# (Sold Separately)	PT-UQC	PT-UQC
<b>Performance</b>		
Capacity* (BTU/h)	12,000 Class	18,000 Class
Fan Air Flow Rate (CMM)	9.5/8.0/7.0	13.0/12.0/11.0
(H/M/L) (CFM)	335/283/247	459/424/388
Dehumidification Rate (pts/hr)	4.2	4.2
Sound Level H/M/L (dB(A)*)	38/35/32	38/37/34
<b>Electrical</b>		
Running Current (A)	0.25	0.25
Power Supply (Ø/V/Hz)	1/208~230/60	1/208~230/60
<b>Piping Connections</b>		
Liquid (inches)	1/4	1/4
Gas (inches)	3/8	1/2
Temperature Sensor	Thermistor	Thermistor
Refrigerant	R-410A	R-410A
Power/Transmission Interunit Cable (No. x AWG)	4 x 18	4 x 18
<b>Dimensions (WxHxD)</b>		
Body (inches)	22 7/16 x 8 7/16 x 22 7/16	22 7/16 x 10 3/32 x 22 7/16
Decorative Panel (inches)	27 9/16 x 7/8 x 27 9/16	27 9/16 x 7/8 x 27 9/16
Net Weight Body (lbs)	30.9	33.1
Net Weight Decorative Panel (lbs)	6.6	6.6

Note :

\*LG verified sounds ratings

1. Capacities are based on the following conditions:

Cooling: - Indoor Temperature 80°F (26.7°C) DB/67°F (19.4°C) WB  
- Outdoor Temperature 95°F (35°C) DB/75°F (23.9°C) WB

Heating: - Indoor Temperature 70°F (21.1°C) DB/60°F (15.6°C) WB  
- Outdoor Temperature 47°F (8.3°C) DB/43°F (6.1°C) WB

Piping Length: - Interconnecting Piping Length 24.6 ft.(7.5m)  
- Level Difference of Zero

2. Wiring cable size must comply with applicable local and national codes.

3. The specification may be subject to change without prior notice for purpose of improvement.

4. For more capacity(\*) information, refer to the combination tables.

Warranty: 2 years parts; 5 years compressor.

# Flex Multi Dual-, Tri-, & Quad Zone

## Electrical & Refrigeration Quick Reference

### Electrical Specifications

Zone	Type	Model	Voltage		Running Current	MCA	MOP
			Indoor	Outdoor			
Flex Multi Indoor Units	H/P	LMN096HVT	208/230	-	0.20	-	-
	H/P	LMAN095HVT	208/230	-	0.15	-	-
	H/P	LMDN095HV	208/230	-	0.25	-	-
	H/P	LMN126HVT	208/230	-	0.20	-	-
	H/P	LMAN125HVT	208/230	-	0.15	-	-
	H/P	LMDN125HV	208/230	-	0.25	-	-
	H/P	LMCN125HV	208/230	-	0.25	-	-
	H/P	LMN186HVT	208/230	-	0.30	-	-
	H/P	LMAN185HVT	208/230	-	0.15	-	-
	H/P	LMDN185HV	208/230	-	0.25	-	-
Flex Multi Outdoor Units	H/P	LMCN185HV	208/230	-	0.25	-	-
	H/P	LMU187HV	-	208/230	-	11.0	15
	H/P	LMU247HV	-	208/230	-	15.4	25
	H/P	LMU369HV	-	208/230	-	16.8	25

All equipment is single phase.

NOTE: Please see local electrical codes for proper wire specifications.

**AJ Madison**  
Your Appliance Authority™  
800-570-3355

### Refrigerant Line & Formula Specifications

	Type	Model	Pipe Size		Additional Refrigerant	Max. Length Each Pipe	Max. Elevation
			Liquid	Suction			
Flex Multi Indoor Units	H/P	LMN096HVT	1/4"	3/8"	0.22 oz./ft.	82'	49'
	H/P	LMAN095HVT	1/4"	3/8"	0.22 oz./ft.	82'	49'
	H/P	LMDN095HV	1/4"	3/8"	0.22 oz./ft.	82'	49'
	H/P	LMN126HVT	1/4"	3/8"	0.22 oz./ft.	82'	49'
	H/P	LMAN125HVT	1/4"	3/8"	0.22 oz./ft.	82'	49'
	H/P	LMDN125HV	1/4"	3/8"	0.22 oz./ft.	82'	49'
	H/P	LMCN125HV	1/4"	3/8"	0.22 oz./ft.	82'	49'
	H/P	LMN186HVT	1/4"	1/2"	0.22 oz./ft.	82'	49'
	H/P	LMAN185HVT	1/4"	1/2"	0.22 oz./ft.	82'	49'
	H/P	LMDN185HV	1/4"	1/2"	0.22 oz./ft.	82'	49'
H/P	LMCN185HV	1/4"	1/2"	0.22 oz./ft.	82'	49'	

Please choose a proper wire size based on local and state code

# Flex Multi Split System Combinations

System	Combined With	Nominal Cooling Capacity Btu/h	EER	SEER	Nominal Heating Capacity Btu/h	COP	Low Heating Capacity Btu/h	COP	HSPF	ENERGY STAR
LMU187HV	Non-Ducted Indoor Units	15,600	14.00	21.0	17,000	3.90	10,000	2.7	9.20	Yes
	Ducted Indoor Units	14,800	11.90	17.7	16,800	3.80	9,900	2.6	8.80	-
	Mixed Ducted & Non-Ducted	15,200	12.95	19.4	16,900	3.85	9,950	2.7	9.00	-
LMU247HV	Non-Ducted Indoor Units	19,200	13.40	21.7	26,400	3.50	16,500	2.6	9.40	Yes
	Ducted Indoor Units	18,000	11.80	16.4	26,200	3.40	16,400	2.6	8.50	-
	Mixed Ducted & Non-Ducted	18,600	12.60	19.1	26,300	3.45	16,450	2.6	8.95	-
LMU369HV	Non-Ducted Indoor Units	34,000	12.50	17.5	41,000	3.40	23,300	2.4	10.5	Yes
	Ducted Indoor Units	34,000	12.00	16.5	41,000	3.20	25,300	2.6	9.5	-
	Mixed Ducted & Non-Ducted	34,000	12.25	17.0	41,000	3.30	24,300	2.5	9.5	-

\* Non-Ducted Indoor Unit Test Condition : Standard Indoor Combination

\* Nominal Cooling Capacity : Outdoor Temperature 95°F

\* Nominal Heating Capacity : Outdoor Temperature 47°F

\* Low Heating Capacity : Outdoor Temperature 17°F

## Controls Accessories

### Wired Controllers and V-net Integration Board



PQRCVSL0



PQRCVSL0QW



PQRCVCL0Q



PQRCVCL0QW

Applied to all Inverter Flex Multi indoor units.

PI485 V-net control integration accessory

Control integration to LG V-net controls  
(AC Smart, ACP, BACnet, LonWorks, etc.)

Applied to Inverter Flex Multi outdoor units.



PMNFP14A0

# Flex Multi Combination of Indoor Units

## LMU187HV Non Ducted Type Indoor Units

### Cooling

Indoor Units	Combination of Indoor Units (kBTU/h Class)					Room Capacity			
	Unit-A	Unit-B	Unit-C	Unit-D	Total	Unit-A (BTU/h)	Unit-B (BTU/h)	Unit-C (BTU/h)	Unit-D (BTU/h)
2 Indoor Units	9	9	-	-	18	7,800	7,800	-	-
	9	12	-	-	21	6,686	8,914	-	-
	12	12	-	-	24	7,800	7,800	-	-

### Heating

Indoor Units	Combination of Indoor Units (kBTU/h Class)					Room Capacity			
	Unit-A	Unit-B	Unit-C	Unit-D	Total	Unit-A (BTU/h)	Unit-B (BTU/h)	Unit-C (BTU/h)	Unit-D (BTU/h)
2 Indoor Units	9	9	-	-	18	8,500	8,500	-	-
	9	12	-	-	21	7,286	9,714	-	-
	12	12	-	-	24	8,500	8,500	-	-

## Ducted Type Indoor Units

### Cooling

Indoor Units	Combination of Indoor Units (kBTU/h Class)					Room Capacity			
	Unit-A	Unit-B	Unit-C	Unit-D	Total	Unit-A (BTU/h)	Unit-B (BTU/h)	Unit-C (BTU/h)	Unit-D (BTU/h)
2 Indoor Units	9	9	-	-	18	7,400	7,400	-	-
	9	12	-	-	21	6,343	8,457	-	-
	12	12	-	-	24	7,400	7,400	-	-

### Heating

Indoor Units	Combination of Indoor Units (kBTU/h Class)					Room Capacity			
	Unit-A	Unit-B	Unit-C	Unit-D	Total	Unit-A (BTU/h)	Unit-B (BTU/h)	Unit-C (BTU/h)	Unit-D (BTU/h)
2 Indoor Units	9	9	-	-	18	8,400	8,400	-	-
	9	12	-	-	21	7,200	9,600	-	-
	12	12	-	-	24	8,400	8,400	-	-

	Total Capacity						Input (W)			Current (A)			EER	SEER
	Min		Rated		Max		Min	Rated	Max	Min	Rated	Max		
	BTU/h	kW	BTU/h	kW	BTU/h	kW								
	10,798	3.16	15,600	4.57	19,000	5.57	924	1,118	2,370	4.2	5.2	10.8	14.0	21.0
	10,798	3.16	15,600	4.57	19,000	5.57	924	1,118	2,370	4.2	5.2	10.8	14.0	21.0
	10,798	3.16	15,600	4.57	19,000	5.57	924	1,118	2,370	4.2	5.2	10.8	14.0	21.0

	Total Capacity						Input (W)			Current (A)			COP	HSPF
	Min		Rated		Max		Min	Rated	Max	Min	Rated	Max		
	BTU/h	kW	BTU/h	kW	BTU/h	kW								
	12,418	3.64	17,000	4.98	21,000	6.15	1,150	1,290	2,480	5.2	6.0	11.3	3.9	9.2
	12,418	3.64	17,000	4.98	21,000	6.15	1,150	1,290	2,480	5.2	6.0	11.3	3.9	9.2
	12,418	3.64	17,000	4.98	21,000	6.15	1,150	1,290	2,480	5.2	6.0	11.3	3.9	9.2

800-570-3355

	Total Capacity						Input (W)			Current (A)			EER	SEER
	Min		Rated		Max		Min	Rated	Max	Min	Rated	Max		
	BTU/h	kW	BTU/h	kW	BTU/h	kW								
	10,798	3.16	14,800	4.34	19,000	5.57	945	1,244	2,370	4.3	5.7	10.8	11.9	17.7
	10,798	3.16	14,800	4.34	19,000	5.57	945	1,244	2,370	4.3	5.7	10.8	11.9	17.7
	10,798	3.16	14,800	4.34	19,000	5.57	945	1,244	2,370	4.3	5.7	10.8	11.9	17.7

	Total Capacity						Input (W)			Current (A)			COP	HSPF
	Min		Rated		Max		Min	Rated	Max	Min	Rated	Max		
	BTU/h	kW	BTU/h	kW	BTU/h	kW								
	12,418	3.64	16,800	4.92	21,000	6.15	1,170	1,306	2,480	5.3	5.9	11.3	3.8	8.8
	12,418	3.64	16,800	4.92	21,000	6.15	1,170	1,306	2,480	5.3	5.9	11.3	3.8	8.8
	12,418	3.64	16,800	4.92	21,000	6.15	1,170	1,306	2,480	5.3	5.9	11.3	3.8	8.8

# Flex Multi Combination of Indoor Units

## LMU247HV Non Ducted Type Indoor Units

### Cooling

Indoor Units	Combination of Indoor Units (kBTU/h Class)					Room Capacity			
	Unit-A	Unit-B	Unit-C	Unit-D	Total	Unit-A (BTU/h)	Unit-B (BTU/h)	Unit-C (BTU/h)	Unit-D (BTU/h)
2 Indoor Units	9	9	-	-	18	8,500	8,500	-	-
	9	12	-	-	21	7,586	10,114	-	-
	12	12	-	-	24	9,600	9,600	-	-
	9	18	-	-	27	6,400	12,800	-	-
	12	18	-	-	30	7,680	11,520	-	-
3 Indoor Units	9	9	9	-	27	6,400	6,400	6,400	-
	9	9	12	-	30	5,760	5,760	5,760	-
	9	12	12	-	33	5,236	6,982	6,982	-

### Heating

Indoor Units	Combination of Indoor Units (kBTU/h Class)					Room Capacity			
	Unit-A	Unit-B	Unit-C	Unit-D	Total	Unit-A (BTU/h)	Unit-B (BTU/h)	Unit-C (BTU/h)	Unit-D (BTU/h)
2 Indoor Units	9	9	-	-	18	10,120	10,120	-	-
	9	12	-	-	21	9,857	13,143	-	-
	12	12	-	-	24	13,200	13,200	-	-
	9	18	-	-	27	8,800	17,600	-	-
	12	18	-	-	30	10,560	15,840	-	-
3 Indoor Units	9	9	9	-	27	8,800	8,800	8,800	-
	9	9	12	-	30	7,920	7,920	7,920	-
	9	12	12	-	33	7,200	9,600	9,600	-

## Ducted Type Indoor Units

### Cooling

Indoor Units	Combination of Indoor Units (kBTU/h Class)					Room Capacity			
	Unit-A	Unit-B	Unit-C	Unit-D	Total	Unit-A (BTU/h)	Unit-B (BTU/h)	Unit-C (BTU/h)	Unit-D (BTU/h)
2 Indoor Units	9	9	-	-	18	8,300	8,300	-	-
	9	12	-	-	21	7,286	9,714	-	-
	12	12	-	-	24	9,000	9,000	-	-
	9	18	-	-	27	6,000	12,000	-	-
	12	18	-	-	30	7,200	10,800	-	-
3 Indoor Units	9	9	9	-	27	6,000	6,000	6,000	-
	9	9	12	-	30	5,000	5,400	5,400	-
	9	12	12	-	33	4,909	6,545	6,545	-

### Heating

Indoor Units	Combination of Indoor Units (kBTU/h Class)					Room Capacity			
	Unit-A	Unit-B	Unit-C	Unit-D	Total	Unit-A (BTU/h)	Unit-B (BTU/h)	Unit-C (BTU/h)	Unit-D (BTU/h)
2 Indoor Units	9	9	-	-	18	10,000	10,000	-	-
	9	12	-	-	21	9,771	13,029	-	-
	12	12	-	-	24	13,100	13,100	-	-
	9	18	-	-	27	8,733	17,467	-	-
	12	18	-	-	30	10,480	15,720	-	-
3 Indoor Units	9	9	9	-	27	8,733	8,733	8,733	-
	9	9	12	-	30	7,860	7,860	7,860	-
	9	12	12	-	33	7,145	9,527	9,527	-

	Total Capacity						Input (W)			Current (A)			EER	SEER
	Min		Rated		Max		Min	Rated	Max	Min	Rated	Max		
	BTU/h	kW	BTU/h	kW	BTU/h	kW								
	10,798	3.16	17,000	4.98	19,800	5.80	1,002	1,349	2,560	4.6	6.1	11.6	12.6	19.0
	11,100	3.25	17,700	5.19	23,100	6.77	1,044	1,383	2,830	4.7	6.3	12.9	12.8	19.0
	11,400	3.34	19,200	5.63	25,500	7.47	1,194	1,469	3,090	5.4	6.7	14.0	13.1	19.0
	11,400	3.34	19,200	5.63	27,500	8.06	1,284	1,469	3,090	5.8	6.7	14.0	13.1	19.0
	11,400	3.34	19,200	5.63	27,500	8.06	1,284	1,469	3,090	5.8	6.7	14.0	13.1	19.0
	11,700	3.43	19,200	5.63	28,800	8.44	1,200	1,431	3,050	5.5	6.6	13.9	13.4	21.7
	11,700	3.43	19,200	5.63	28,800	8.44	1,200	1,431	3,050	5.5	6.6	13.9	13.4	21.7
	11,700	3.43	19,200	5.63	28,800	8.44	1,200	1,431	3,050	5.5	6.6	13.9	13.4	21.7

	Total Capacity						Input (W)			Current (A)			COP	HSPF
	Min		Rated		Max		Min	Rated	Max	Min	Rated	Max		
	BTU/h	kW	BTU/h	kW	BTU/h	kW								
	12,418	3.64	20,240	5.93	23,700	6.95	1,200	1,951	2,660	5.5	8.9	12.1	3.0	7.7
	12,765	3.74	23,000	6.74	27,700	8.12	1,260	2,174	3,010	5.7	9.9	13.7	3.1	7.7
	16,200	4.75	26,400	7.74	29,040	8.51	1,368	2,320	3,100	6.2	10.5	14.1	3.3	8.2
	16,200	4.75	26,400	7.74	31,500	9.23	1,428	2,320	3,100	6.5	10.5	14.1	3.3	8.2
	16,200	4.75	26,400	7.74	31,500	9.23	1,428	2,320	3,100	6.5	10.5	14.1	3.3	8.2
	16,200	4.75	26,400	7.74	32,000	9.38	1,308	2,207	3,090	5.9	10.2	14.0	3.5	9.4
	16,200	4.75	26,400	7.74	32,000	9.38	1,308	2,207	3,090	5.9	10.2	14.0	3.5	9.4
	16,200	4.75	26,400	7.74	32,000	9.38	1,308	2,207	3,090	5.9	10.2	14.0	3.5	9.4

800-570-3355

	Total Capacity						Input (W)			Current (A)			EER	SEER
	Min		Rated		Max		Min	Rated	Max	Min	Rated	Max		
	BTU/h	kW	BTU/h	kW	BTU/h	kW								
	10,798	3.16	16,600	4.87	19,800	5.80	1,042	1,495	2,560	4.7	6.8	11.6	11.1	14.4
	12,000	3.52	17,000	4.98	23,100	6.77	1,084	1,504	2,830	4.9	6.8	12.9	11.3	14.4
	12,300	3.60	18,000	5.28	25,500	7.47	1,234	1,565	3,090	5.6	7.1	14.0	11.5	14.4
	12,300	3.60	18,000	5.28	27,500	8.06	1,324	1,565	3,090	6.0	7.1	14.0	11.5	14.4
	12,300	3.60	18,000	5.28	27,500	8.06	1,324	1,565	3,090	6.0	7.1	14.0	11.5	14.4
	12,300	3.60	18,000	5.28	28,800	8.44	1,260	1,525	3,050	5.7	6.9	13.9	11.8	16.4
	12,300	3.60	18,000	5.28	28,800	8.44	1,260	1,525	3,050	5.7	6.9	13.9	11.8	16.4
	12,300	3.60	18,000	5.28	28,800	8.44	1,260	1,525	3,050	5.7	6.9	13.9	11.8	16.4

	Total Capacity						Input (W)			Current (A)			COP	HSPF
	Min		Rated		Max		Min	Rated	Max	Min	Rated	Max		
	BTU/h	kW	BTU/h	kW	BTU/h	kW								
	12,418	3.64	20,000	5.86	23,700	6.95	1,240	1,967	2,660	5.6	8.9	12.1	3.0	7.9
	13,800	4.04	22,800	6.68	27,700	8.12	1,300	2,191	3,010	5.9	10.0	13.7	3.0	7.9
	16,500	4.84	26,200	7.68	29,040	8.51	1,408	2,327	3,100	6.4	10.6	14.1	3.3	8.1
	16,500	4.84	26,200	7.68	31,500	9.23	1,468	2,327	3,100	6.7	10.6	14.1	3.3	8.1
	16,500	4.84	26,200	7.68	31,500	9.23	1,468	2,327	3,100	6.7	10.6	14.1	3.3	8.1
	16,500	4.84	26,200	7.68	32,000	9.38	1,368	2,226	3,090	6.2	10.3	14.0	3.4	8.5
	16,500	4.84	26,200	7.68	32,000	9.38	1,368	2,226	3,090	6.2	10.3	14.0	3.4	8.5
	16,500	4.84	26,200	7.68	32,000	9.38	1,368	2,226	3,090	6.2	10.3	14.0	3.4	8.5

# Flex Multi Combination of Indoor Units

## LMU369HV

### Non Ducted Type Indoor Units

#### Cooling

Indoor Units	Combination of Indoor Units (kBTU/h Class)					Room Capacity			
	Unit-A	Unit-B	Unit-C	Unit-D	Total	Unit-A (BTU/h)	Unit-B (BTU/h)	Unit-C (BTU/h)	Unit-D (BTU/h)
2 Indoor Units	9	9	-	-	18	9,000	9,000	-	-
	9	12	-	-	21	9,000	12,000	-	-
	12	12	-	-	24	12,000	12,000	-	-
	9	18	-	-	27	9,000	18,000	-	-
	12	18	-	-	30	11,600	17,400	-	-
3 Indoor Units	18	18	-	-	36	18,000	18,000	-	-
	9	9	9	-	27	9,000	9,000	9,000	-
	9	9	12	-	30	9,000	9,000	12,000	-
	9	12	12	-	33	9,000	12,000	12,000	-
	12	12	12	-	36	11,333	11,333	11,333	-
	9	9	18	-	36	8,500	8,500	17,000	-
	9	12	18	-	39	7,846	10,462	15,692	-
	12	12	18	-	42	9,714	9,714	14,571	-
	9	18	18	-	45	6,800	13,600	13,600	-
	12	18	18	-	48	8,500	12,750	12,750	-
4 Indoor Units	9	9	9	9	36	8,500	8,500	8,500	8,500
	9	9	9	12	39	7,846	7,846	7,846	10,462
	9	9	12	12	42	7,286	7,286	9,714	9,714
	9	12	12	12	45	6,800	9,067	9,067	9,067
	9	9	9	18	45	6,800	6,800	6,800	13,600
	12	12	12	12	48	8,500	8,500	8,500	8,500

#### Heating

Indoor Units	Combination of Indoor Units (kBTU/h Class)					Room Capacity			
	Unit-A	Unit-B	Unit-C	Unit-D	Total	Unit-A (BTU/h)	Unit-B (BTU/h)	Unit-C (BTU/h)	Unit-D (BTU/h)
2 Indoor Units	9	9	-	-	18	10,350	10,350	-	-
	9	12	-	-	21	10,350	13,800	-	-
	12	12	-	-	24	13,800	13,800	-	-
	9	18	-	-	27	10,350	20,700	-	-
	12	18	-	-	30	13,800	20,700	-	-
3 Indoor Units	18	18	-	-	36	19,000	19,000	-	-
	9	9	9	-	27	10,350	10,350	10,350	-
	9	9	12	-	30	10,350	10,350	13,800	-
	9	12	12	-	33	10,350	13,800	13,800	-
	12	12	12	-	36	13,667	13,667	13,667	-
	9	9	18	-	36	10,250	10,250	20,500	-
	9	12	18	-	39	9,462	12,615	18,923	-
	12	12	18	-	42	11,714	11,714	17,571	-
	9	18	18	-	45	8,200	16,400	16,400	-
	12	18	18	-	48	10,250	15,375	15,375	-
4 Indoor Units	9	9	9	9	36	10,250	10,250	10,250	10,250
	9	9	9	12	39	9,462	9,462	9,462	12,615
	9	9	12	12	42	8,786	8,786	11,714	11,714
	9	12	12	12	45	8,200	10,933	10,933	10,933
	9	9	9	18	45	8,200	8,200	8,200	16,400
	12	12	12	12	48	10,250	10,250	10,250	10,250

	Total Capacity						Input (W)			Current (A)			EER	SEER
	Min		Rated		Max		Min	Rated	Max	Min	Rated	Max		
	BTU/h	kW	BTU/h	kW	BTU/h	kW								
10,798	3.2	18,000	5.3	19,800	5.8	1,140	1,900	2,586	5.0	8.3	11.3	9.5	13.5	
12,597	3.7	21,000	6.2	23,100	6.8	1,266	2,110	2,872	5.5	9.2	12.5	10.0	14.1	
14,397	4.2	24,000	7.0	26,400	7.7	1,392	2,320	3,158	6.1	10.1	13.8	10.3	14.7	
16,197	4.7	27,000	7.9	29,700	8.7	1,452	2,420	3,294	6.3	10.6	14.4	11.2	15.8	
17,397	5.1	29,000	8.5	32,000	9.4	1,560	2,600	3,539	6.8	11.3	15.4	11.2	15.8	
21,596	6.3	36,000	10.5	39,600	11.6	1,728	2,880	3,920	7.5	12.6	17.1	12.5	17.8	
16,197	4.7	27,000	7.9	29,700	8.7	1,452	2,420	3,294	6.3	10.6	14.4	11.2	15.8	
17,996	5.3	30,000	8.8	33,000	9.7	1,560	2,600	3,539	6.8	11.3	15.4	11.5	16.4	
19,796	5.8	33,000	9.7	36,300	10.6	1,644	2,740	3,729	7.2	11.9	16.3	12.0	17.1	
20,396	6.0	34,000	10.0	37,400	11.0	1,632	2,720	3,702	7.1	11.9	16.1	12.5	17.5	
20,396	6.0	34,000	10.0	37,400	11.0	1,632	2,720	3,702	7.1	11.9	16.1	12.5	17.5	
20,396	6.0	34,000	10.0	37,400	11.0	1,632	2,720	3,702	7.1	11.9	16.1	12.5	17.5	
20,396	6.0	34,000	10.0	37,400	11.0	1,632	2,720	3,702	7.1	11.9	16.1	12.5	17.5	
20,396	6.0	34,000	10.0	37,400	11.0	1,632	2,720	3,702	7.1	11.9	16.1	12.5	17.5	
20,396	6.0	34,000	10.0	37,400	11.0	1,632	2,720	3,702	7.1	11.9	16.1	12.5	17.5	
20,396	6.0	34,000	10.0	37,400	11.0	1,632	2,720	3,702	7.1	11.9	16.1	12.5	17.5	
20,396	6.0	34,000	10.0	37,400	11.0	1,632	2,720	3,702	7.1	11.9	16.1	12.5	17.5	
20,396	6.0	34,000	10.0	37,400	11.0	1,632	2,720	3,702	7.1	11.9	16.1	12.5	17.5	
20,396	6.0	34,000	10.0	37,400	11.0	1,632	2,720	3,702	7.1	11.9	16.1	12.5	17.5	
20,396	6.0	34,000	10.0	37,400	11.0	1,632	2,720	3,702	7.1	11.9	16.1	12.5	17.5	
20,396	6.0	34,000	10.0	37,400	11.0	1,632	2,720	3,702	7.1	11.9	16.1	12.5	17.5	
20,396	6.0	34,000	10.0	37,400	11.0	1,632	2,720	3,702	7.1	11.9	16.1	12.5	17.5	
20,396	6.0	34,000	10.0	37,400	11.0	1,632	2,720	3,702	7.1	11.9	16.1	12.5	17.5	
20,396	6.0	34,000	10.0	37,400	11.0	1,632	2,720	3,702	7.1	11.9	16.1	12.5	17.5	

	Total Capacity						Input (W)			Current (A)			COP	HSPF
	Min		Rated		Max		Min	Rated	Max	Min	Rated	Max		
	BTU/h	kW	BTU/h	kW	BTU/h	kW								
12,418	3.6	20,700	6.1	22,770	6.7	1,248	2,080	2,416	5.4	9.1	10.5	2.9	9.3	
14,487	4.2	24,150	7.1	26,510	7.8	1,524	2,540	2,950	6.6	11.1	12.9	2.8	8.9	
16,557	4.9	27,600	8.1	30,360	8.9	1,554	2,590	3,008	6.8	11.3	13.1	3.1	10.0	
18,626	5.5	31,050	9.1	33,000	9.7	1,740	2,900	3,368	7.6	12.6	14.7	3.1	10.0	
20,696	6.1	34,500	10.1	36,300	10.6	1,932	3,220	3,740	8.4	14.0	16.3	3.1	10.0	
22,795	6.7	38,000	11.1	37,400	11.0	2,118	3,530	4,100	9.2	15.4	17.9	3.2	10.1	
18,626	5.5	31,050	9.1	34,100	10.0	1,740	2,900	3,368	7.6	12.6	14.7	3.1	10.0	
20,696	6.1	34,500	10.1	37,400	11.0	1,932	3,220	3,740	8.4	14.0	16.3	3.1	10.0	
22,765	6.7	37,950	11.1	38,500	11.3	2,040	3,400	3,949	8.9	14.8	17.2	3.3	10.4	
24,595	7.2	41,000	12.0	45,100	13.2	2,148	3,580	4,153	9.4	15.6	18.1	3.4	10.5	
24,595	7.2	41,000	12.0	45,100	13.2	2,148	3,580	4,153	9.4	15.6	18.1	3.4	10.5	
24,595	7.2	41,000	12.0	45,100	13.2	2,148	3,580	4,153	9.4	15.6	18.1	3.4	10.5	
24,595	7.2	41,000	12.0	45,100	13.2	2,148	3,580	4,153	9.4	15.6	18.1	3.4	10.5	
24,595	7.2	41,000	12.0	45,100	13.2	2,148	3,580	4,153	9.4	15.6	18.1	3.4	10.5	
24,595	7.2	41,000	12.0	45,100	13.2	2,148	3,580	4,153	9.4	15.6	18.1	3.4	10.5	
24,595	7.2	41,000	12.0	45,100	13.2	2,148	3,580	4,153	9.4	15.6	18.1	3.4	10.5	
24,595	7.2	41,000	12.0	45,100	13.2	2,148	3,580	4,153	9.4	15.6	18.1	3.4	10.5	
24,595	7.2	41,000	12.0	45,100	13.2	2,148	3,580	4,153	9.4	15.6	18.1	3.4	10.5	
24,595	7.2	41,000	12.0	45,100	13.2	2,148	3,580	4,153	9.4	15.6	18.1	3.4	10.5	
24,595	7.2	41,000	12.0	45,100	13.2	2,148	3,580	4,153	9.4	15.6	18.1	3.4	10.5	
24,595	7.2	41,000	12.0	45,100	13.2	2,148	3,580	4,153	9.4	15.6	18.1	3.4	10.5	
24,595	7.2	41,000	12.0	45,100	13.2	2,148	3,580	4,153	9.4	15.6	18.1	3.4	10.5	

# Flex Multi Combination of Indoor Units

## LMU369HV Ducted Type Indoor Units

### Cooling

Indoor Units	Combination of Indoor Units (kBTU/h Class)					Room Capacity			
	Unit-A	Unit-B	Unit-C	Unit-D	Total	Unit-A (BTU/h)	Unit-B (BTU/h)	Unit-C (BTU/h)	Unit-D (BTU/h)
2 Indoor Units	9	9	-	-	18	9,000	9,000	-	-
	9	12	-	-	21	9,000	12,000	-	-
	12	12	-	-	24	12,000	12,000	-	-
	9	18	-	-	27	9,000	18,000	-	-
	12	18	-	-	30	11,600	17,400	-	-
3 Indoor Units	18	18	-	-	36	16,500	16,500	-	-
	9	9	9	-	27	9,000	9,000	9,000	-
	9	9	12	-	30	9,000	9,000	12,000	-
	9	12	12	-	33	9,000	12,000	12,000	-
	12	12	12	-	36	11,333	11,333	11,333	-
	9	9	18	-	36	8,500	8,500	17,000	-
	9	12	18	-	39	7,846	10,462	15,692	-
	12	12	18	-	42	9,714	9,714	14,571	-
4 Indoor Units	9	18	18	-	45	6,800	13,600	13,600	-
	12	18	18	-	48	8,500	12,750	12,750	-
	9	9	9	9	36	8,500	8,500	8,500	8,500
	9	9	9	12	39	7,846	7,846	7,846	10,462
	9	9	12	12	42	7,286	7,286	9,714	9,714
	9	12	12	12	45	6,800	9,067	9,067	9,067
	9	9	9	18	45	6,800	6,800	6,800	13,600
12	12	12	12	48	8,500	8,500	8,500	8,500	

### Heating

Indoor Units	Combination of Indoor Units (kBTU/h Class)					Room Capacity			
	Unit-A	Unit-B	Unit-C	Unit-D	Total	Unit-A (BTU/h)	Unit-B (BTU/h)	Unit-C (BTU/h)	Unit-D (BTU/h)
2 Indoor Units	9	9	-	-	18	10,350	10,350	-	-
	9	12	-	-	21	10,350	13,800	-	-
	12	12	-	-	24	13,800	13,800	-	-
	9	18	-	-	27	10,350	20,700	-	-
	12	18	-	-	30	13,800	20,700	-	-
3 Indoor Units	18	18	-	-	36	19,000	19,000	-	-
	9	9	9	-	27	10,350	10,350	10,350	-
	9	9	12	-	30	10,350	10,350	13,800	-
	9	12	12	-	33	10,350	13,800	13,800	-
	12	12	12	-	36	13,667	13,667	13,667	-
	9	9	18	-	36	10,250	10,250	20,500	-
	9	12	18	-	39	9,462	12,615	18,923	-
	12	12	18	-	42	11,714	11,714	17,571	-
4 Indoor Units	9	18	18	-	45	8,200	16,400	16,400	-
	12	18	18	-	48	10,250	15,375	15,375	-
	9	9	9	9	36	10,250	10,250	10,250	10,250
	9	9	9	12	39	9,462	9,462	9,462	12,615
	9	9	12	12	42	8,786	8,786	11,714	11,714
	9	12	12	12	45	8,200	10,933	10,933	10,933
	9	9	9	18	45	8,200	8,200	8,200	16,400
12	12	12	12	48	10,250	10,250	10,250	10,250	

	Total Capacity						Input (W)			Current (A)			EER	SEER
	Min		Rated		Max		Min	Rated	Max	Min	Rated	Max		
	BTU/h	kW	BTU/h	kW	BTU/h	kW								
10,798	3.2	18,000	5.3	19,800	5.8	1,188	1,980	2,695	5.2	8.6	11.7	9.1	12.7	
12,597	3.7	21,000	6.2	23,100	6.8	1,320	2,200	2,995	5.8	9.6	13.1	9.5	13.4	
14,397	4.2	24,000	7.0	26,400	7.7	1,452	2,420	3,294	6.3	10.6	14.4	9.9	13.9	
16,197	4.7	27,000	7.9	29,700	8.7	1,518	2,530	3,443	6.6	11.0	15.0	10.7	14.9	
17,397	5.1	29,000	8.5	32,000	9.4	1,626	3,710	3,688	7.1	11.8	16.1	10.7	15.0	
19,796	5.8	33,000	9.7	35,000	10.3	1,800	3,000	4,083	7.8	13.1	17.8	11.0	15.4	
16,197	4.7	27,000	7.9	29,700	8.7	1,518	2,530	3,443	6.6	11.0	15.0	10.7	14.9	
17,996	5.1	30,000	8.8	33,000	9.7	1,626	3,710	3,688	7.1	11.8	16.1	11.1	15.5	
19,796	5.8	33,000	9.7	36,300	10.6	1,716	2,860	3,892	7.5	12.5	17.0	11.5	16.2	
20,396	6.0	34,000	10.0	37,400	11.0	1,704	2,840	3,865	7.4	12.5	16.9	12.0	16.5	
20,396	6.0	34,000	10.0	37,400	11.0	1,704	2,840	3,865	7.4	12.5	16.9	12.0	16.5	
20,396	6.0	34,000	10.0	37,400	11.0	1,704	2,840	3,865	7.4	12.5	16.9	12.0	16.5	
20,396	6.0	34,000	10.0	37,400	11.0	1,704	2,840	3,865	7.4	12.5	16.9	12.0	16.5	
20,396	6.0	34,000	10.0	37,400	11.0	1,704	2,840	3,865	7.4	12.5	16.9	12.0	16.5	
20,396	6.0	34,000	10.0	37,400	11.0	1,704	2,840	3,865	7.4	12.5	16.9	12.0	16.5	
20,396	6.0	34,000	10.0	37,400	11.0	1,704	2,840	3,865	7.4	12.5	16.9	12.0	16.5	
20,396	6.0	34,000	10.0	37,400	11.0	1,704	2,840	3,865	7.4	12.5	16.9	12.0	16.5	
20,396	6.0	34,000	10.0	37,400	11.0	1,704	2,840	3,865	7.4	12.5	16.9	12.0	16.5	
20,396	6.0	34,000	10.0	37,400	11.0	1,704	2,840	3,865	7.4	12.5	16.9	12.0	16.5	
20,396	6.0	34,000	10.0	37,400	11.0	1,704	2,840	3,865	7.4	12.5	16.9	12.0	16.5	
20,396	6.0	34,000	10.0	37,400	11.0	1,704	2,840	3,865	7.4	12.5	16.9	12.0	16.5	
20,396	6.0	34,000	10.0	37,400	11.0	1,704	2,840	3,865	7.4	12.5	16.9	12.0	16.5	
20,396	6.0	34,000	10.0	37,400	11.0	1,704	2,840	3,865	7.4	12.5	16.9	12.0	16.5	
20,396	6.0	34,000	10.0	37,400	11.0	1,704	2,840	3,865	7.4	12.5	16.9	12.0	16.5	

800-570-3355

	Total Capacity						Input (W)			Current (A)			COP	HSPF
	Min		Rated		Max		Min	Rated	Max	Min	Rated	Max		
	BTU/h	kW	BTU/h	kW	BTU/h	kW								
12,418	3.6	20,700	6.1	22,770	6.7	1,302	2,170	2,520	5.7	9.5	11.0	2.8	8.5	
14,487	4.2	24,150	7.1	26,510	7.8	1,536	2,560	2,973	6.7	11.2	13.0	2.8	8.8	
16,557	4.9	27,600	8.1	30,360	8.9	1,614	2,690	3,124	7.0	11.7	13.6	3.0	9.0	
18,626	5.5	31,050	9.1	33,000	9.7	1,812	3,020	3,508	7.9	13.2	15.3	3.0	9.0	
20,696	6.1	34,500	10.1	36,300	10.6	2,010	3,350	3,891	8.8	14.6	17.0	3.0	9.0	
22,795	6.7	38,000	11.1	37,400	11.0	2,208	3,680	4,274	9.6	16.0	18.6	3.0	9.0	
18,626	5.5	31,050	9.1	34,100	10.0	1,812	3,020	3,508	7.9	13.2	15.3	3.0	9.0	
20,696	6.1	34,500	10.1	37,400	11.0	2,010	3,350	3,891	8.8	14.6	17.0	3.0	9.0	
22,765	6.7	37,950	11.1	38,500	11.3	2,130	3,550	4,123	9.3	15.5	18.0	3.1	9.2	
24,595	7.2	41,000	12.0	45,100	13.2	2,232	3,720	4,321	9.7	16.2	18.8	3.2	9.5	
24,595	7.2	41,000	12.0	45,100	13.2	2,232	3,720	4,321	9.7	16.2	18.8	3.2	9.5	
24,595	7.2	41,000	12.0	45,100	13.2	2,232	3,720	4,321	9.7	16.2	18.8	3.2	9.5	
24,595	7.2	41,000	12.0	45,100	13.2	2,232	3,720	4,321	9.7	16.2	18.8	3.2	9.5	
24,595	7.2	41,000	12.0	45,100	13.2	2,232	3,720	4,321	9.7	16.2	18.8	3.2	9.5	
24,595	7.2	41,000	12.0	45,100	13.2	2,232	3,720	4,321	9.7	16.2	18.8	3.2	9.5	
24,595	7.2	41,000	12.0	45,100	13.2	2,232	3,720	4,321	9.7	16.2	18.8	3.2	9.5	
24,595	7.2	41,000	12.0	45,100	13.2	2,232	3,720	4,321	9.7	16.2	18.8	3.2	9.5	
24,595	7.2	41,000	12.0	45,100	13.2	2,232	3,720	4,321	9.7	16.2	18.8	3.2	9.5	
24,595	7.2	41,000	12.0	45,100	13.2	2,232	3,720	4,321	9.7	16.2	18.8	3.2	9.5	
24,595	7.2	41,000	12.0	45,100	13.2	2,232	3,720	4,321	9.7	16.2	18.8	3.2	9.5	
24,595	7.2	41,000	12.0	45,100	13.2	2,232	3,720	4,321	9.7	16.2	18.8	3.2	9.5	
24,595	7.2	41,000	12.0	45,100	13.2	2,232	3,720	4,321	9.7	16.2	18.8	3.2	9.5	
24,595	7.2	41,000	12.0	45,100	13.2	2,232	3,720	4,321	9.7	16.2	18.8	3.2	9.5	
24,595	7.2	41,000	12.0	45,100	13.2	2,232	3,720	4,321	9.7	16.2	18.8	3.2	9.5	
24,595	7.2	41,000	12.0	45,100	13.2	2,232	3,720	4,321	9.7	16.2	18.8	3.2	9.5	



800-570-3355

**INNOVATIVE COMFORT SOLUTIONS**

# Packaged Terminal Air Conditioners

Ultra-quiet operation is the hallmark of LG's new line of PTAC products. Low decibel levels and an outstanding sound-prevention rating make this your best choice for a quiet environment. And with efficiency ratings up to 11.6 EER, these units are also your energy efficient choice.

Other features include standard connections for remote thermostat and front desk controls. Gold Fin™ technology protects the unit from the corrosive effects of outside air and extends the operating life of PTAC models. And the industry standard size makes installation easy and economical.



7,000-15,000 BTUs



Digital Control Panel

Product

# Packaged Terminal Air Conditioners

## PTAC Features & Benefits



### R-410A Refrigerant

Ozone-Friendly  
Refrigerant utilized in the majority of LG systems



### Digital Control Display Includes:

- **Temperature Display on Unit**  
Precise and easy to use.  
ADA compliant.
- **Cooling, Heating and Fan Modes**  
One unit for all seasons.
- **Energy Saver Mode**  
Helps to lower energy consumption  
operational costs and saves money.
- **Auto Restart**  
Automatically restarts to programmed  
setting when the electricity comes on  
after a power failure.

### Ventilation Filter

Polymeric mesh filter allows clean, fresh air into the living space. Suitable for hospitality, health care, assisted living applications.

### Separate Indoor & Outdoor Motors\*

Dual motor configuration allows the lowest sound rating in the industry while also promoting the highest level of energy efficiency for LG.



### Emergency Heat

(Heat pump models only) Bypasses compressor operation and activates the ceramic or coil heater during periods of extreme cold. Promotes high level of guest comfort.

### Freeze Room Protection

Electronic temperature controls constantly monitor and maintain indoor temperature to prevent freezing.

1-year full system warranty, parts and labor. Warranty on unit for years 2-5: parts only, exclusive of the refrigeration system. Warranty on sealed refrigeration system: 5 year, parts and labor.

**Defrost Control**

(Heat pump models only)  
Shuts down the indoor fan to prevent cold air from being blown into the room. Also removes frost from outdoor coil when the outdoor temperature is low.

**Sensors**

4 Sensors provide highly efficient operation and maximize guest comfort.

**Pressure Control**

Protects guests by shutting down the compressor on abnormal high pressure condition

**High-Efficiency Rotary Compressor**

Energy efficient and maintenance-free operation.

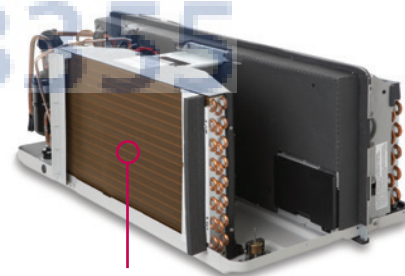

**Gold Fin™ Anti-Corrosion**

Protects the unit from the corrosive effects of outside air and extends the operating life of PTAC models. LG's patented process is standard on ALL LG PTAC models.



**Ceramic Heater**

Uniform, stable and safe heating platform.

\*230V 2.5 & 3.5kW only

**Dip Switch Setting**

Saves money by allowing owner to control the Lowest & Highest temperature

**Power Cord**

Included (Contact your local LG rep for confirmation)



# Packaged Terminal Air Conditioners

7,000-15,000 BTUs Digital Control (230/208V)



- LP073CD2(3)A (H/C Model)**  
7,400 BTUs Cooling & Heating
- LP093CD3A (H/C Model)**  
9,000 BTUs Cooling & Heating
- LP123CD3A (H/C Model)**  
11,800 BTUs Cooling & Heating
- LP153CD3(5)A (H/C Model)**  
14,300 BTUs Cooling & Heating



- LP073HD2(3)A (Heat Pump Model)**  
7,400 BTUs Cooling & Heating
- LP093HD3A (Heat Pump Model)**  
9,000 BTUs Cooling & Heating
- LP123HD3A (Heat Pump Model)**  
11,800 BTUs Cooling & Heating
- LP153HD3(5)A (Heat Pump Model)**  
14,700 BTUs Cooling & Heating



## FEATURES:

- Gold Fin™ anti-corrosion treatment
- Cooling mode
- Heating mode
- Fan mode
- Energy saver mode
- Auto restart
- Digital temperature control
- Front desk control connection
- Dip switch settings
- Evaporator frost control
- Temperature display on unit
- Freeze room protection
- Pressure control
- Ceramic heater(2.5&3.5kW only)

System Includes:

- Wall unit
- Installation manual
- UL# : SA13362

\* Specification can be changed without notification

System Model #	LP073CD2A LP073CD3A	LP093CD3A	LP123CD3A	LP153CD3A LP153CD5A	LP073HD2A LP073HD3A	LP093HD3A	LP123HD3A	LP153HD3A LP153HD5A
Control Type	Digital	Digital	Digital	Digital	Digital	Digital	Digital	Digital
<b>Performance</b>								
Capacity (BTUs)	C 7,400/7,200 H	9,000/8,800	11,800/11,600	14,300/14,100	7,400/7,200 6,400/6,200	9,000/8,800 8,100/7,900	11,800/11,600 10,800/10,600	14,700/14,500 12,100/11,900
Refrigerant	R-410A	R-410A	R-410A	R-410A	R-410A	R-410A	R-410A	R-410A
EER	11.6	11.0	10.6	9.2	11.6	11.0	10.6	9.4
Air Circulation (CFM H/L)	247/212	255/220	353/318	388/353	247/212	247/212	353/318	388/353
Fan Speeds (Cooling/Heating/Fan)	2/2/2	2/2/2	2/2/2	2/2/2	2/2/2	2/2/2	2/2/2	2/2/2
Dehumidification (pts/hr)	1.6 (LP073CD2A) 2.0 (LP073CD3A)	2.3	2.8	3.9 (LP153CD3A) 4.4 (LP153CD5A)	1.6 (LP073HD2A) 2.0 (LP073HD3A)	2.3	2.9	4.1 (LP153HD3A) 4.6 (LP153HD5A)
Indoor dB(A)*	45/43	46/44	50/48	50/48	45/43	46/44	50/48	51 / 49
Outdoor dB(A)*	61	61	63	63	61	61	63	64
STC	30	30	30	30	30	30	30	30
<b>Electrical</b>								
Rated Voltage	230/208-60-1	230/208-60-1	230/208-60-1	230/208-60-1	230/208-60-1	230/208-60-1	230/208-60-1	230/208-60-1
Electric Heater (kW)	2.5 (LP073CD2A) 3.5 (LP073CD3A)	3.5	3.5	3.5 (LP153CD3A) 5 (LP153CD5A)	2.5 (LP073HD2A) 3.5 (LP073HD3A)	3.5	3.5	3.5 (LP153HD3A) 5 (LP153HD5A)
Circuit Breaker (A)	15 (LP073CD2A) 20 (LP073CD3A)	20	20	20 (LP153CD3A) 30 (LP153CD5A)	15 (LP073HD2A) 20 (LP073HD3A)	20	20	20 (LP153HD3A) 30 (LP153HD5A)
<b>Dimension</b>								
W x H x D (inches)	42 x 16 x 19 7/8	42 x 16 x 19 7/8	42 x 16 x 19 7/8	42 x 16 x 19 7/8	42 x 16 x 19 7/8	42 x 16 x 19 7/8	42 x 16 x 19 7/8	42 x 16 x 19 7/8
Weight (lbs.)	93	101.6	101.6	105.8	95.7	105.2	105.2	113.8
<b>Thermostat Range</b>								
Cooling/Heating (°F)**	54-86/54-86	54-86/54-86	54-86/54-86	54-86/54-86	54-86/54-86	54-86/54-86	54-86/54-86	54-86/54-86

\*LG verified sound rating

\*\*Adjustable by temperature limiting with DIP switches on the unit

1-year full system warranty, parts and labor. Warranty on unit for years 2-5: parts only, exclusive of the refrigeration system.  
Warranty on sealed refrigeration system: 5 year, parts and labor.

# Packaged Terminal Air Conditioners

7,000-15,000 BTUs Digital Control (265V)



- C**
- LP076CD2(3)A** (H/C Model)  
7,200 BTUs Cooling & Heating
  - LP096CD3A** (H/C Model)  
9,000 BTUs Cooling & Heating
  - LP126CD3A** (H/C Model)  
11,800 BTUs Cooling & Heating
  - LP156CD3(5)A** (H/C Model)  
14,000 BTUs Cooling & Heating

- C H**
- LP076HD2(3)A** (Heat Pump Model)  
7,300 BTUs Cooling & Heating
  - LP096HD3A** (Heat Pump Model)  
9,200 BTUs Cooling & Heating
  - LP126HD3A** (Heat Pump Model)  
11,800 BTUs Cooling & Heating
  - LP156HD3(5)A** (Heat Pump Model)  
14,700 BTUs Cooling & Heating

\* Sub Base assembly is mandatory for models rated 265V. (UL standard)

## FEATURES:

- Gold Fin™ anti-corrosion treatment
- Cooling mode
- Heating mode
- Fan mode
- Energy saver mode
- Auto restart
- Digital temperature control
- Front desk control connection
- Dip switch settings
- Evaporator frost control
- Temperature display on unit
- Freeze room protection
- Pressure control

System Includes:

- Wall unit
- Installation manual
- UL# : SA13362

\* Specification can be changed without notification

System Model #	LP076CD2A LP076CD3A	LP096CD3A	LP126CD3A	LP156CD3A LP156CD5A	LP076HD2A LP076HD3A	LP096HD3A	LP126HD3A	LP156HD3A LP156HD5A
Control Type	Digital	Digital	Digital	Digital	Digital	Digital	Digital	Digital
<b>Performance</b>								
Capacity (BTUs)	7,200	9,000	11,800	14,000	7,300	9,200	11,800	14,700
Refrigerant	R-410A	R-410A	R-410A	R-410A	R-410A	R-410A	R-410A	R-410A
EER	11.0	10.5	10.2	9.0	11.2	10.8	10.4	9.4
Air Circulation (CFM H/L)	265/235	290/260	388/358	388/358	265/235	290/260	346/316	388/358
Fan Speeds (Cooling/Heating/Fan)	2/2/2	2/2/2	2/2/2	2/2/2	2/2/2	2/2/2	2/2/2	2/2/2
Dehumidification (pts/hr)	1.5 (LP076CD2A) 2.0 (LP076CD3A)	2.0	2.6	3.8 (LP156CD3A) 4.4 (LP156CD5A)	1.5 (LP076HD2A) 2.0 (LP076HD3A)	2.2	2.4	4.1 (LP156HD3A) 4.6 (LP156HD5A)
Indoor dB(A)*	45/43	46/44	50/48	50/48	45/43	46/44	50/48	51/49
Outdoor dB(A)*	61	61	63	63	61	61	63	64
STC	30	30	30	30	30	30	30	30
<b>Electrical</b>								
Rated Voltage	265-60-1	265-60-1	265-60-1	265-60-1	265-60-1	265-60-1	265-60-1	265-60-1
Electric Heater (kW)	2.0 (LP076CD2A) 3.7 (LP076CD3A)	3.5	3.5	3.5 (LP156CD3A) 5 (LP156CD5A)	2.0 (LP076HD2A) 3.7 (LP076HD3A)	3.5	3.5	3.5 (LP156HD3A) 5 (LP156HD5A)
Circuit Breaker (A)	15 (LP076CD2A) 20 (LP076CD3A)	20	20	20 (LP156CD3A) 30 (LP156CD5A)	15 (LP076HD2A) 20 (LP076HD3A)	20	20	20 (LP156HD3A) 30 (LP156HD5A)
<b>Dimension</b>								
W x H x D (inches)	42 x 16 x 19 7/8	42 x 16 x 19 7/8	42 x 16 x 19 7/8	42 x 16 x 19 7/8	42 x 16 x 19 7/8	42 x 16 x 19 7/8	42 x 16 x 19 7/8	42 x 16 x 19 7/8
Weight (lbs.)	93.0	103.8	103.8	108.2	97.9	107.4	107.4	116
<b>Thermostat Range</b>								
Cooling/Heating (°F)**	54-86/54-86	54-86/54-86	54-86/54-86	54-86/54-86	54-86/54-86	54-86/54-86	54-86/54-86	54-86/54-86

\*LG verified sound rating

\*\*Adjustable by temperature limiting with DIP switches on the unit

1-year full system warranty, parts and labor. Warranty on unit for years 2-5: parts only, exclusive of the refrigeration system.  
Warranty on sealed refrigeration system: 5 year, parts and labor.

# Through-The-Wall Air Conditioners

## Through-the-Wall Air Conditioners

LG's Through-The-Wall models offer versatile, energy efficient solutions for residential and light commercial applications.

All models feature Gold Fin™ Technology which protects the unit from the corrosive effects of salt air and can extend the units operating life.

Sizes range from 8,000–14,000 BTUs, and both cooling only and heat/cool models are offered. Also, the standard size chassis fits into any competitive wall sleeve, providing an easy upgrade for an existing system.

## TTW Features & Benefits

### Gold Fin™ Anti-Corrosion

Protects the unit from the corrosive effects of outside air and extends the operating life of TTW models.

### Push Button Shift Mode

Allows you to switch between cool and heat with ease.

### 24-Hour On/Off Timer

Allows you to set the number of hours you'd like the unit to run, up to 24 hours.

### Auto Sleep Mode

Automatically increases the temperature setting 2° F twice (after 1/2 hour and one hour). The interior unit shuts off when the timer setting is reached.

### Auto Restart

Automatically restarts a unit to programmed setting when the electricity comes on after a power failure.



### Remote Control

Easy to use Wireless Remote Control.

### Trim Kit

Unit has a nice, finished look when placed into an existing wall sleeve.

# Through-The-Wall Air Conditioners

8,000-14,000 BTUs



**LT081CNR** (A/C Model)  
8,000 BTUs Cooling

**LT101CNR**(A/C Model)  
9,800 BTUs Cooling

**LT103CNR** (A/C Model)  
10,000 BTUs Cooling

**LT121CNR** (A/C Model)  
11,500 BTUs Cooling

**LT123CNR** (A/C Model)  
11,500 BTUs Cooling

**LT143CNR** (A/C Model)  
13,000 BTUs Cooling



## FEATURES:

- Gold Fin™ anti-corrosion treatment
- Cooling mode
- Fan mode
- Auto sleep mode
- Auto restart
- 24-Hour on/off timer

### System Includes:

- Wall unit
- Remote control and batteries
- Installation manual
- Trim Kit

UL# : SA7244



\* Specification can be changed without notification

System Model #	LT081CNR	LT101CNR	LT103CNR	LT121CNR	LT123CNR	LT143CNR
<b>Performance</b>						
Capacity (BTUs)	8,000	9,800	10,000/9,800	11,500	11,500/11,200	13,000/12,600
EER	8.8	8.8	8.8	8.8	8.8/8.8	8.5/8.5
Air Circulation (CFM H/L)	260/220	285/225	285/225	290/230	290/230	310/250
Fan Speeds (Cooling/Fan)	3/3	3/3	3/3	3/3	3/3	3/3
Dehumidification (pts/hr)	2.2	3.2	3.2	3.8	3.8	4.0
Indoor dB(A)*	49/46	51/48	51/48	52/49	52/49	53/50
Outdoor dB(A)*	59	60	60	61	61	62
<b>Electrical</b>						
Rated Voltage	115-60-1	115-60-1	230/208-60-1	115-60-1	230/208-60-1	230/208-60-1
Circuit Breaker (A)	15	20	15	20	15	15
<b>Dimensions</b>						
W x H x D (inches)	24 x 14 13/32 x 20 3/32	24 x 14 13/32 x 20 3/32	24 x 14 13/32 x 20 3/32	24 x 14 13/32 x 20 3/32	24 x 14 13/32 x 20 3/32	24 x 14 13/32 x 20 3/32
Weight (lbs.)	73.0	78.0	78.0	80.0	80.0	87.0
<b>Thermostat Range</b>						
Cooling (°F)	60-86	60-86	60-86	60-86	60-86	60-86

\*LG verified sound rating

Warranty : 1 years parts, labor, and compressor.

# Through-The-Wall Air Conditioners

10,000-12,000 BTUs

C H

**LT103HNR** (H/C Model)

10,000 BTUs Cooling & Heating

**LT123HNR** (H/C Model)

11,500 BTUs Cooling & Heating



## FEATURES:

- Gold Fin™ anti-corrosion treatment
- Cooling mode
- Heating mode
- Fan mode
- Auto sleep mode
- Auto restart
- 24-Hour on/off timer

### System Includes:

- Wall unit
- Remote control and batteries
- Installation manual
- Trim Kit

UL# : SA7244

\* Specification can be changed without notification

System Model #	LT103HNR	LT123HNR
<b>Performance</b>		
Capacity (BTUs)	C 10,000/9,800 H 11,200/9,200	11,500/11,200 11,200/9,200
EER	9.4/9.4	8.8/8.8
Air Circulation (CFM H/L)	285/225	290/230
Fan Speeds (Cooling/Heating/Fan)	2/2/2	2/2/2
Dehumidification (pts/hr)	3.2	3.8
Indoor dB(A)*	51/48	52/49
Outdoor dB(A)*	60	61
<b>Electrical</b>		
Rated Voltage	230/208-60-1	230/208-60-1
Circuit Breaker (A)	20	20
<b>Dimensions</b>		
W x H x D (inches)	24 21/32 x 14 13/32 x 19 21/32	24 21/32 x 14 13/32 x 19 21/32
Weight (lbs.)	78.0	80.0
<b>Thermostat Range</b>		
Cooling/Heating (°F)	60-86	60-86

\*LG verified sound rating

Warranty : 1 years parts, labor, and compressor.

# Through-The-Wall Air Conditioners

## Optional Accessories

Description	Model #
26" Wall Sleeve	AXSVA1
Stamped Aluminum Grille	AXRGALA01
Wall Sleeve with Stamped Aluminum Grille	AXSVA4
Architectural Grille	AXAGALA01A

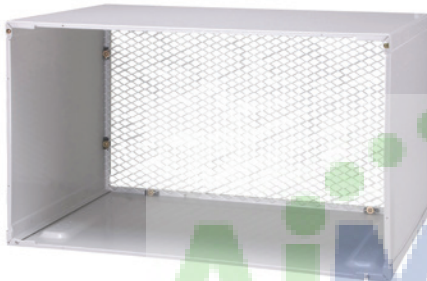

Wall Sleeve  
AXSVA1



Stamped Aluminum Grille  
AXRGALA01

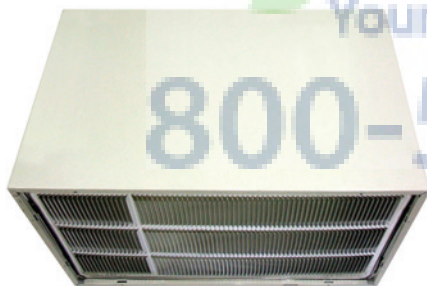

Wall Sleeve with Stamped  
Aluminum Grill  
AXSVA4



Architectural Grille  
AXAGALA01A(Aluminum Color)

Also Available in dark bronze and soft dove color. Please contact Ruskin Company at 1-800-239-4621 for more information

Sleeve Dimensions of Major Brands (inches)	Friedrich USC Sleeve	GE	Amana	Whirlpool Fedders	Frigidaire	LG
Height	15 17/32	15 5/8	15 5/8	15 3/4	15 7/16	15 17/32
Width	25 7/8	26	26	26 3/4	25 7/8	25 7/8
Depth	16 23/32	16 7/8	16 7/8	15	18	16 23/32

Inside dimension of LG Sleeve (W x H x D, inches): 25 5/16 x 14 7/8 x 15 5/16



LG Electronics, Air Conditioning Division  
1000 Sylvan Ave., Englewood Cliffs, NJ 07632

LG Electronics, Commercial Air Conditioning Division  
11405 Old Roswell Road, Alpharetta, GA 30009

For technical support on a DFS and PTAC TTW Product call 888-865-3026, press 2.  
For general information call your local LG Sales Representative.  
[www.lghvac.com](http://www.lghvac.com)