



ENGLISH

ESPAÑOL

OWNER'S MANUAL

AIR CONDITIONER

Please read this manual carefully before operating your set and retain it for future reference.

TYPE : PORTABLE AIR CONDITIONER

MODEL : LP0817WSR
LP1017WSR
LP1217GSR
LP1417GSR

www.lg.com

INTRODUCTION

IMPORTANT SAFETY INSTRUCTIONS

Basic Safety Precautions	3 - 6
Electrical Safety	6, 7

PARTS AND FEATURES

Key Parts and Components	8
--------------------------	---

HOW TO USE

Before Using Your Air Conditioner	9, 10
Control Panel and Remote	11, 12

INSTALLATION INSTRUCTIONS

Preparing for Installation	13
Selection of Installation Location	14
Attaching the Hose and Diffuser	14
Window Vent Panel and Extensions	15
Installation in Vertical Sliding Windows	16, 17
Installation in Casement Style Windows	18, 19

CARE AND CLEANING

Water Drainage	20
Cleaning the Case	21
Cleaning the Air Filter	21
Storing the Air Conditioner	22

TROUBLESHOOTING

Before Calling for Service	23, 24
----------------------------	--------

WARRANTY

Product Registration Information	25
----------------------------------	----

THANK YOU!

Congratulations on your purchase
and welcome to the LG family.

Your new LG Air Conditioner
combines high-efficiency operation
with portable convenience.

If you follow the operating and care
instructions in this manual, your air
conditioner will provide you with
many years of reliable service.

IMPORTANT SAFETY INSTRUCTIONS

BASIC SAFETY PRECAUTIONS

To prevent injury to the user or other people and property damage, the following instructions must be followed.

■ Incorrect operation due to ignoring instruction will cause harm or damage. The seriousness is classified by the following indications.

⚠ WARNING This symbol indicates the possibility of death or serious injury.

⚠ CAUTION This symbol indicates the possibility of injury or damage to properties only.

■ Meanings of symbols used in this manual are as shown below.

	Be sure not to do.
	Be sure to follow the instruction.

⚠ WARNING

■ Installation

Don't use a power cord, a plug, or a loose socket which is damaged.

• Otherwise, it may cause a fire or electrical shock.



Always plug into a grounded outlet.

• Otherwise, it may cause a fire or electrical shock.

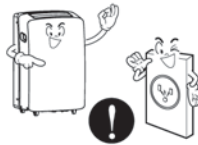

Do not modify or extend the power cord length.

• It will cause electric shock or fire due to heat generation.

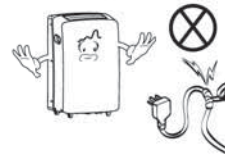

Do not disassemble or modify products.

• It may cause failure and electric shock.



Be caution when unpacking and installing.

• Sharp edges may cause injury.



Do not store flammables like gasoline, benzene, thinner, etc. near the air conditioner.

• It may cause explosion or fire.



IMPORTANT SAFETY INSTRUCTIONS

■ Operation

Do not place heavy object on the power cord and take care so that the cord should not be pressed.

- There is danger of fire or electric shock.

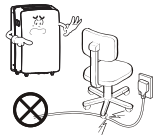

Do not share the outlet with other appliances.

- It will cause electric shock or fire due to heat generation.



Take the power plug out if necessary, holding the head of the plug and do not touch it with wet hands.

- Otherwise, it may cause a fire or electrical shock.



Do not place the power cord near a heater.

- It may cause fire and electric shock.

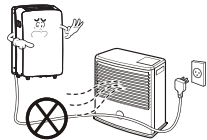

Do not allow water to run into electric parts.

- It will cause failure of machine or electric shock.



Use a soft cloth to clean. Do not use wax, thinner, or a strong detergent.

- The appearance of the air conditioner may deteriorate, change color, or develop surface flaws.



Unplug the unit if strange sounds, odors, or smoke come from it.

- Otherwise it may cause fire and electric shock accident.



Turn off the power and breaker first when cleansing the unit.

- Since the fan rotates at high speed during operation, it may cause injury.



If water enters the product, turn off the power switch of the main body of appliance. Contact service center after taking the power-plug out from the socket.



Unplug the unit when not using it for a long time.

- Prevent accidental startup and the possibility of injury.

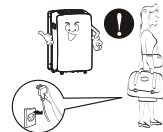

Do not operate or stop the unit by inserting or pulling out the power plug.

- It will cause electric shock or fire due to heat generation.



Do not damage or use an unspecified power cord.

- It will cause electric shock or fire.



IMPORTANT SAFETY INSTRUCTIONS

ENGLISH

Do not operate with wet hands or in damp environment.

- It will cause electric shock.



Hold the plug by the head (not the cable) when taking it out.

- It may cause electric shock and damage.



When gas leaks, open the window for ventilation before operating the unit.

- Otherwise, it may cause explosion, and a fire.



For inner cleaning, contact an Authorized Service Center or a dealer. Do not use harsh detergent that causes corrosion or damage on the unit. Harsh detergent may also cause failure of product, fire, or electric shock.

California Safe Drinking Water and Toxic Enforcement Act
 This product contains chemicals known to the State of California to cause cancer and birth defects or other reproductive harm. *Wash hands after handling.*

CAUTION

Operation

Do not use this appliance for special purposes such as cooling pets, foods, precision machinery, or objects of art

- It is an air conditioner, not a precision refrigeration system.



Do not block the inlet or outlet of air flow.

- It may cause product failure.

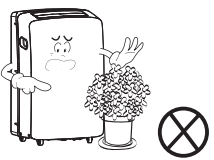

Use a soft cloth to clean. Do not use wax, thinner, or a strong detergent.

- The appearance of the air conditioner may deteriorate, change color, or develop surface flaws.



Do not step on the indoor/outdoor unit and do not put anything on it.

- It may cause an injury through dropping of the unit or falling down.



Always insert the filter securely. Clean it every two weeks.

- Operation without filters will cause failure.

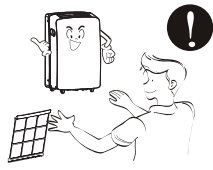

Do not drink water drained from air conditioner.

- It contains contaminants and will make you sick.



IMPORTANT SAFETY INSTRUCTIONS

If the liquid from the battery gets onto your skin or clothes, wash it well with clean water. Do not use the remote if the battery has leaked.

- The chemicals in battery could cause burns or other health hazards.



If you eat the liquid from the battery, brush your teeth and see doctor. Do not use the remote if the battery has leaked.

- The chemicals in battery could cause burns or other health hazards.



ELECTRICAL SAFETY

⚠ WARNING

Electrical Shock Hazard

Failure to follow these instructions can result in death, fire, or electrical shock.

- This unit must be properly grounded.
- Do not, under any circumstances, cut or remove the ground prong.
- If you do not have a properly grounded outlet, or if there is any doubt that the outlet is not properly grounded, a qualified electrician should check the outlet and circuit, and, if necessary, install a properly grounded outlet.

- This air conditioner must be plugged into a grounded 60 Hz, 120 VAC outlet protected by a 15 amp time delay fuse or circuit breaker.
- This air conditioner must be installed in accordance with national wiring codes.
- Do not alter or modify the plug or cord of this air conditioner. If the power cord becomes worn or damaged, the cord should only be replaced by a qualified service technician using genuine replacement parts.
- Do not use an extension cord.

IMPORTANT SAFETY INSTRUCTIONS

READ ALL INSTRUCTIONS BEFORE USE

ENGLISH

ELECTRICAL SAFETY

INTEGRATED CIRCUIT BREAKER

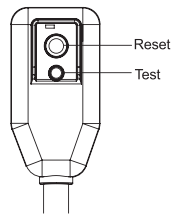

For additional safety, the power cord features an integrated circuit breaker. Test and reset buttons are provided on the plug case.

The circuit breaker should be tested periodically by pressing the TEST button then the RESET button. If the TEST button does not cause the circuit breaker to trip, or if the RESET button will not stay engaged, unplug the air conditioner immediately and contact your LG service technician.

PREFERRED GROUNDING METHOD

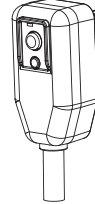

Ensure proper ground exists before use.

TEMPORARY GROUNDING METHOD

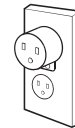

Ensure proper ground exists before use.

Due to potential safety hazards, the use of an adapter plug is strongly discouraged.

For temporary connections, use only a UL-listed adapter. Ensure that the large slot in the adapter is aligned with the large slot in the outlet.

To prevent damage to the adapter's ground terminal, hold the adapter in place while plugging in or unplugging the air conditioner.

- **Attaching the adapter ground terminal to the wall receptacle cover screw does not ground the appliance unless the cover screw is metal and not insulated, and the wall receptacle is grounded through the house wiring.**

- **Frequent connection and disconnection can damage the ground terminal on the adapter. Never use a broken or damaged adapter.**

SAVE THESE INSTRUCTIONS

PARTS AND FEATURES

KEY PARTS AND COMPONENTS

1 AIR DISCHARGE

The adjustable louvered air discharge opens automatically when the air conditioner is turned on, and closes when it is turned off. It can also be set to oscillate to distribute air more evenly through the room.

2 CONTROL PANEL AND DISPLAY

Easy-to-read digital display shows the set temperature and indicator lights show the operating mode. Simple push buttons make changing settings quick and easy.

3 SWIVELING CASTERS

Swiveling casters allow you to move the air conditioner easily on most floor surfaces.

4 INTEGRATED HANDLES

Integrated handles provide a convenient grip when lifting the air conditioner.

5 INFRARED REMOTE CONTROLLER

The remote controller allows you to adjust the temperature and operate most functions of the air conditioner from across the room.

6 BOTTOM DRAIN PORT

Before moving the air conditioner, drain the internal water in the collection tank completely by using bottom drain port.

7 AIR FILTER

8 HOSE AND DIFFUSER

Use the diffuser and hose to connect the air conditioner to the window installation kit to vent exhaust air outside.

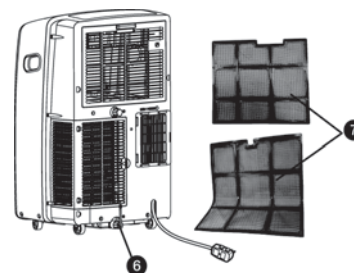
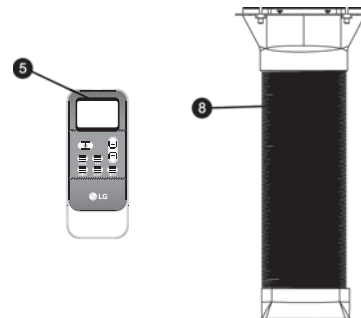
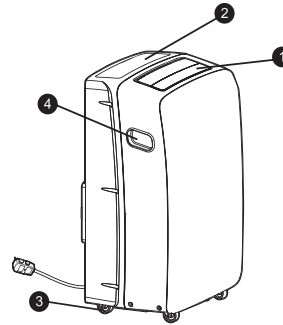

HOW TO USE

ENGLISH

BEFORE USING YOUR AIR CONDITIONER

PREPARING FOR OPERATION

Refer to the Installation Instructions included in this manual before using the air conditioner. Once the air conditioner has been properly assembled and installed:

- 1 Plug the power cord into its own dedicated properly grounded outlet. Do not plug other appliances into the same outlet; it could overload the outlet and create a fire hazard.
- 2 Make sure the air conditioner and cord is positioned where it does not create a tripping hazard and will receive adequate ventilation. Do not place it directly next to furniture or objects that could block the vent openings.
- 3 Make sure that any items that could be blown over or damaged by the airflow from the fan are out of the airflow path.

IMPORTANT:

- Do not remain in the direct airflow from the air conditioner for extended periods of time.
- When used at the same time as stoves, fireplaces, and other combustion devices, make sure there is a sufficient flow of fresh air into the room. Do not use in tightly enclosed spaces with these types of devices.
- This air conditioner is intended for household use as a consumer comfort appliance. Do not use it as a precision climate control system, or for purposes such as cooling precision equipment, food, pets, plants, artwork, etc. Such items could be damaged.
- Do not bend the hose downward when window installation kit is not applied. It may cause failure of air conditioner or performance deterioration.

UNPACKING THE AIR CONDITIONER

Remove and store packing materials for reuse. Remove any shipping tape before using the air conditioner. If the tape leaves behind any adhesive, rub a small amount of liquid dish soap onto it and wipe with a damp cloth. Do NOT use sharp instruments, alcohol, thinners, or abrasive cleaners to remove adhesive. They could damage the finish.

HOW TO USE

BEFORE USING YOUR AIR CONDITIONER

INSERTING BATTERIES IN THE REMOTE

Before using your remote, install the provided AAA batteries.

- 1 Press and glide the battery cover on the back of the remote, then you can remove the cover.
- 2 Insert two new alkaline AAA batteries into the battery compartment, being sure to note the proper polarity.
- 3 Reattach the battery cover.

NOTE :

- Use only alkaline batteries. Do not use rechargeable batteries.
- When replacing batteries, always replace both batteries with new batteries. Do not mix old and new batteries. Do not mix alkaline, standard (carbon-zinc), or rechargeable (ni-cad, ni-mh, etc) batteries.
- If the air conditioner will not be used for an extended period of time, remove the batteries from the remote.

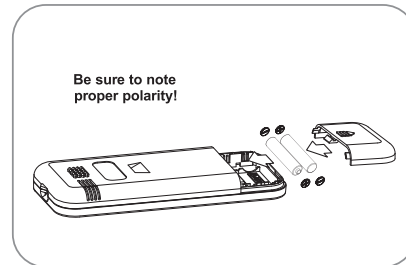

⚠ CAUTION

- **If the liquid from the batteries gets onto your skin or clothes, wash it well with clean water.**
Do not use the remote if the batteries have leaked.
- **If you eat the liquid from the batteries, brush your teeth and see doctor.**
The chemicals in batteries could cause burns or other health hazards.

HOW TO USE

ENGLISH

CONTROL PANEL AND REMOTE

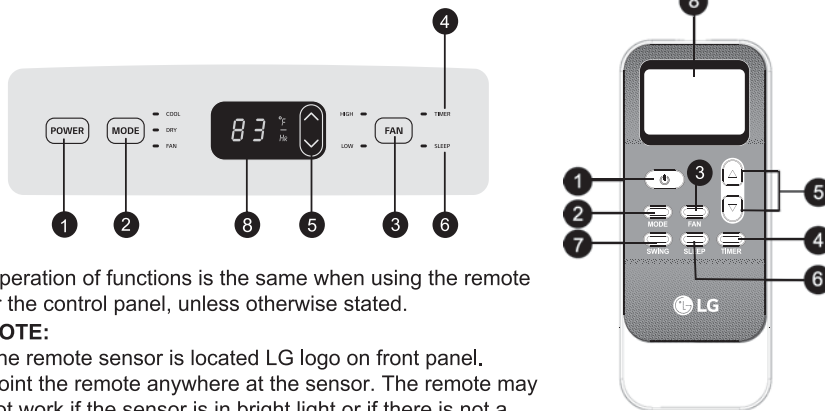

Operation of functions is the same when using the remote or the control panel, unless otherwise stated.

NOTE:

The remote sensor is located LG logo on front panel. Point the remote anywhere at the sensor. The remote may not work if the sensor is in bright light or if there is not a clear path between the remote and the sensor.

1 POWER

Turns the air conditioner on and off. When turning on, a rising tone will sound to confirm. When turning off, a descending tone will sound.

2 MODE

Press this button to select the operating mode such as Cool, Dry (Dehumidify), or Fan for the air conditioner. And you can see the active mode through the indicator lights. The default setting is Cool. Press the MODE button to change to Dry (Dehumidify), press again to change to Fan, and again to change to Cool.

Mode	Features
COOL	Compressor runs and cools the room. Use the ▲ / ▼ and FAN buttons to set the desired temperature and circulation fan speed.
FAN	Fan circulates air but compressor does not run. Use the FAN button to set the desired fan speed.
DRY	Dry mode is used to remove humidity from the room without additional cooling. Fan speed is pre-set and cannot be adjusted.

3 FAN

Adjusts the circulation fan speed between High and Low fan speed. The selected fan speed will be shown through the indicator lights. The function can be used in Cool and Fan modes. When changing fan speeds, there is a brief delay before the fan motor changes speed.

4 TIMER

It is convenient to set the timer on with TIMER ON/OFF before you leave so that you will come back to the comfortable room temperature you set. This function can be activated from the remote only. TIMER ON can be set in the air conditioner operation off and TIMER OFF can be set in the air conditioner operation on. Setting method is the same that TIMER ON/OFF. TIMER button can be used to turn on the unit automatically at the time you set. Use the ▲ / ▼ buttons to adjust the delay time from 0 to 24 hours, in one hour increments or decrements. When your desired time displayed on LCD, press the TIMER button to confirm it. Press TIMER button again, a "beep" can be heard and the indicator disappears, the TIMER mode has been canceled. TIMER OFF of the set time, with the exception of when you want to set the display LED of control panel, can not be confirmed. You can check in only on the remote control.

HOW TO USE

CONTROL PANEL AND REMOTE

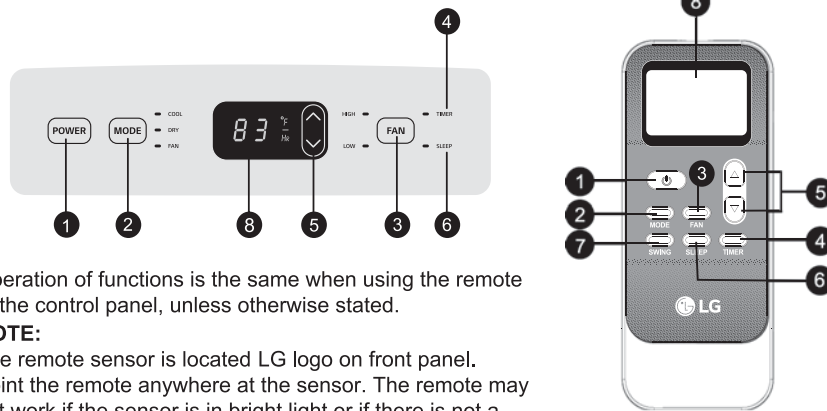

Operation of functions is the same when using the remote or the control panel, unless otherwise stated.

NOTE:

The remote sensor is located LG logo on front panel. Point the remote anywhere at the sensor. The remote may not work if the sensor is in bright light or if there is not a clear path between the remote and the sensor.

5 ▲ / ▼ (TEMP/TIMER)

In COOL modes, the ▲/▼ buttons adjust the set temperature up to 86°F or down to 60°F, in one degree increments. When the TIMER function is selected, use the ▲/▼ buttons to adjust the delay time from 0 to 24 hours, in one hour increments.

NOTE: The displayed temperature is the SET temperature, not the room temperature. In COOL mode, the thermostat in the air conditioner will run the compressor until the set temperature is reached, then cycle the compressor on and off to maintain the set temperature.

6 SLEEP

SLEEP mode can be set in Cool, Dry, Fan operation mode. This function gives you a more comfortable environment for sleep. The appliance will stop operation automatically after operating for 8 hours. Fan speed is automatically set at low speed. This function can be activated from the remote only.

7 SWING

Sets the motorized air discharge to oscillate, improving air circulation in the room. This function can be activated from the remote only. If air discharge is not closed by any operation, please disconnect and reconnect the power cord.

8 LED DISPLAY

LED display shows the set temperature, fan speed, or the selected TIMER delay. Indicators will light to show active mode and additional settings. The LED display will show the E5 to indicate when the internal water drain tank needs to be emptied.

INSTALLATION INSTRUCTIONS

ENGLISH

PREPARING FOR INSTALLATION

⚠ WARNING The air conditioner is heavy! Use two or more people to lift and install the unit! Failure to do so could result in back injury or other injuries.

EXHAUST COMPONENTS

The following components are used for window venting. Not all components are used for every installation.

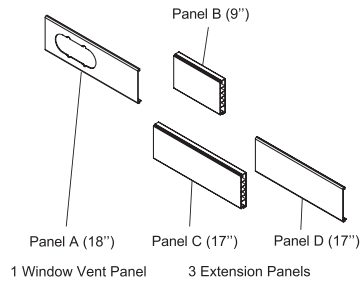

Window Installation Kit (includes 1 Window Vent Panel and 3 Extension Panels)

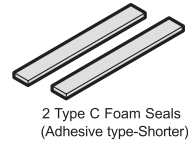
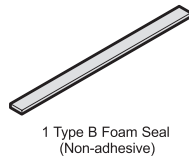
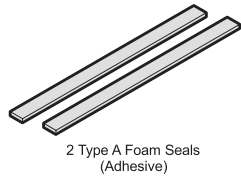

INSTALLATION INSTRUCTIONS

SELECTION OF INSTALLATION LOCATION

- 1 Place the unit on a level floor.
- 2 For best performance, allow at least 20 in of air space on all sides of the unit for good air circulation.
- 3 Place the unit near a window. The hose and diffuser will be used to connect the air conditioner to the window installation kit to vent exhaust air outside.

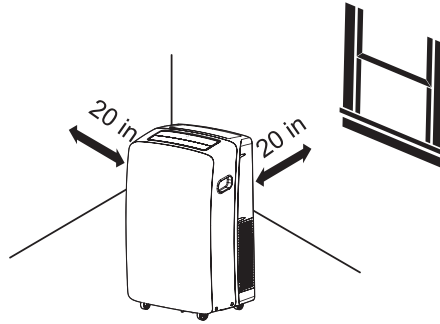

⚠ WARNING

The length of the exhaust hose is specially designed according to the specification of this product. Do not replace or extend it with your own private hose as this could cause malfunction.

ATTACHING THE HOSE AND DIFFUSER

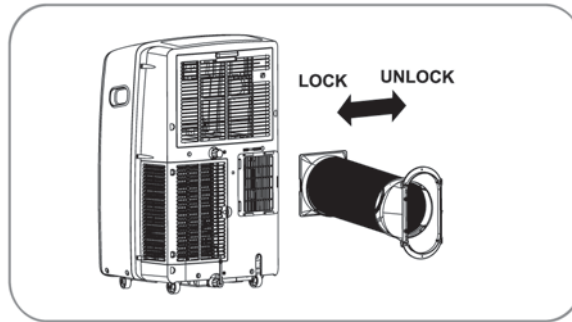

Insert the vent hose into the hole on the back of the air conditioner.

INSTALLATION INSTRUCTIONS

WINDOW VENT PANEL AND EXTENSIONS

The window installation kit allows you to install the air conditioner in most vertical-sliding windows 18" to 50" wide, or casement-style windows from 18" to 50" high.

ENGLISH

Panel	A	B	C	D	Fig.
Window Length	18"	9"	17"	17"	
18"	✓				a
19" - 26"	✓	✓			b
27" - 34"	✓		✓		c
35" - 50"	✓		✓	✓	d

1. Please check your window length and choose the fit panels from the above table.
2. If your window length need more than 2 panels, after adjust the length, please use type A screw to fix them.

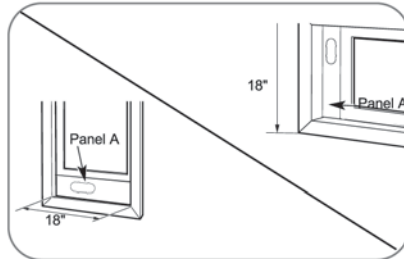
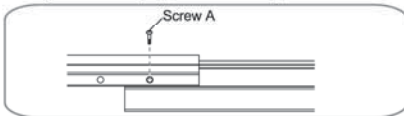

For an 18" window opening, use the window vent panel by itself.

Fig. "a"

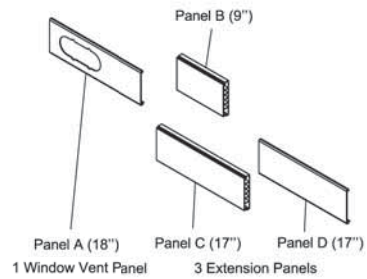

Window Installation Kit (includes 1 Window Vent Panel and 3 Extension Panels)

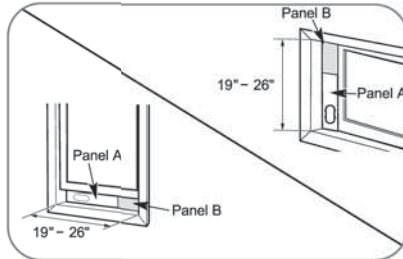

For window openings from 19" to 26", use the window vent panel (Panel A) and a extension panel (Panel B).

Fig. "b"

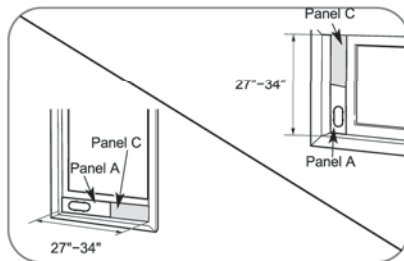

For window openings from 27" to 34", use the window vent panel (Panel A) and a extension panel (Panel C).

Fig. "c"

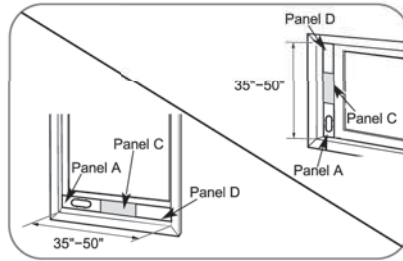

For window openings from 35" to 50", use the window vent panel and two extension panels (Panel C and Panel D).

Fig. "d"

INSTALLATION INSTRUCTIONS

INSTALLATION IN VERTICAL SLIDING WINDOWS

NOTE: The window installation kit can be used with vertical sliding windows between 18" and 50" wide.

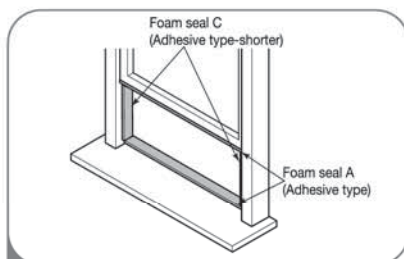

- 1 Cut the foam seal A (adhesive type) & C (adhesive type-shorter) to the proper length, and attach it to the window sash and frame.

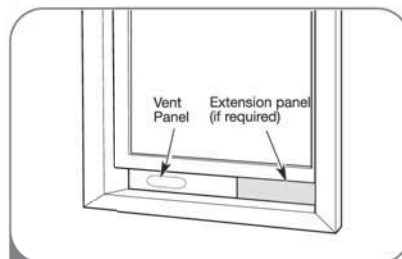

- 2 Insert the vent panel assembly, including extension panels, if needed, into the window opening. Extend the extension panels, if used.

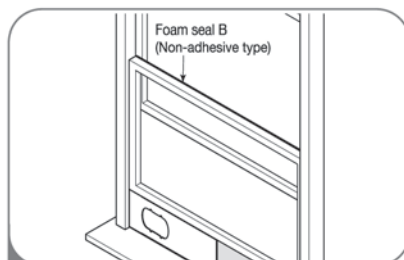

- 3 Cut the foam seal B (Non-adhesive type) to the window width. Stuff the foam seal B between the glass and the window to prevent air and insects from getting into the room.

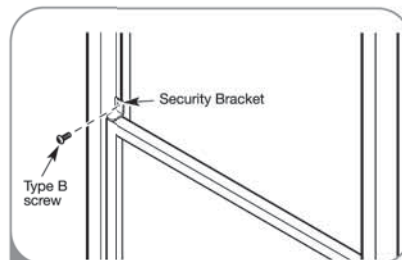

- 4 Install the security bracket with a type B screw as shown if you need.

INSTALLATION INSTRUCTIONS

INSTALLATION IN VERTICAL SLIDING WINDOWS

ENGLISH

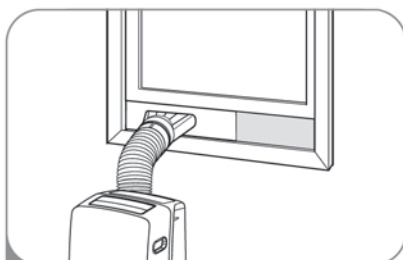

5 Insert the diffuser into the Vent Panel. And then slide.

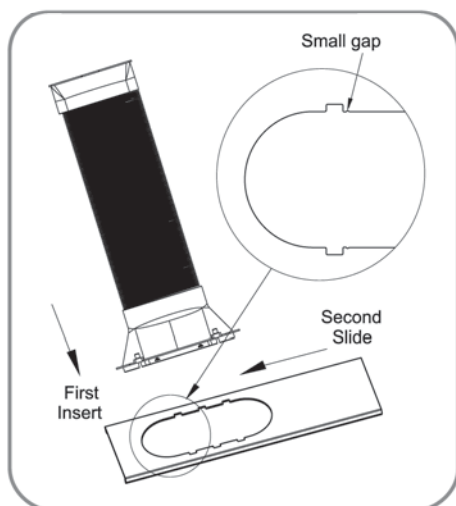

First insert to the vent panel fully and then slide for locking.

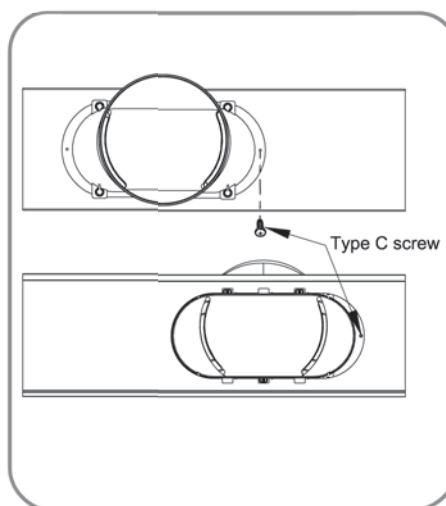

If you want fix the diffuser more firmly, use the type C screw.

INSTALLATION INSTRUCTIONS

INSTALLATION IN CASEMENT STYLE WINDOWS

NOTE: The window installation kit can be used with casement windows between 18" and 50" tall.

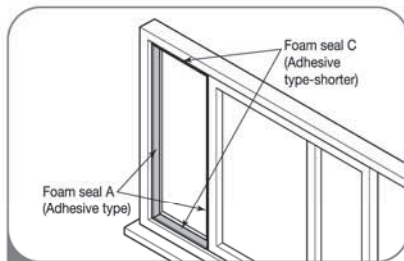

- 1 Cut the foam seal A (adhesive type) & C (adhesive type-shorter) to the proper length, and attach it to the window sash and frame.

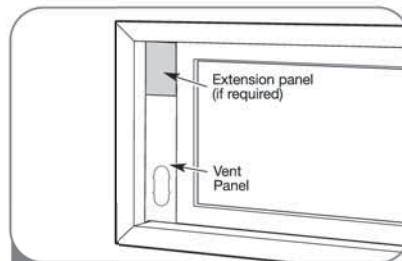

- 2 Insert the vent panel assembly, including extension panels, if needed, into the window opening. Extend the extension panels, if used.

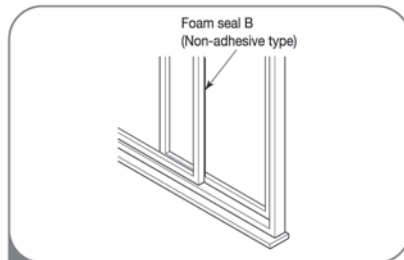

- 3 Cut the foam seal B (Non-adhesive type) to the window height. Stuff the foam seal B between the glass and the window to prevent air and insects from getting into the room.

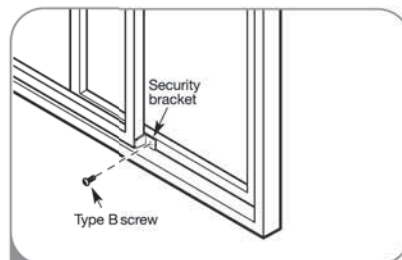

- 4 Install the window security bracket with a type B screw as shown.

INSTALLATION INSTRUCTIONS

INSTALLATION IN CASEMENT STYLE WINDOWS

ENGLISH

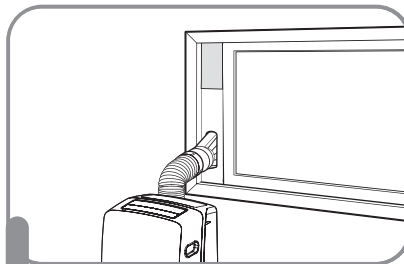

5 Insert the diffuser into the Vent Panel. And then slide.

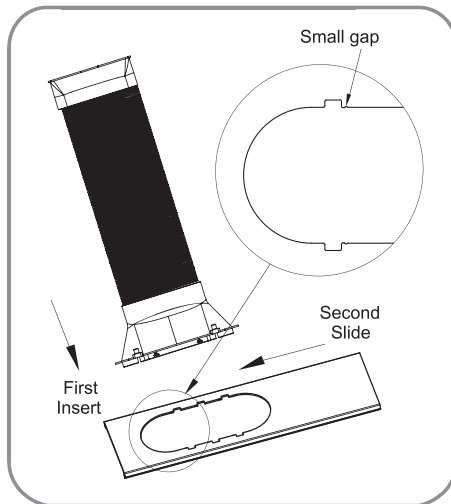

First insert to the vent panel fully and then slide for locking.

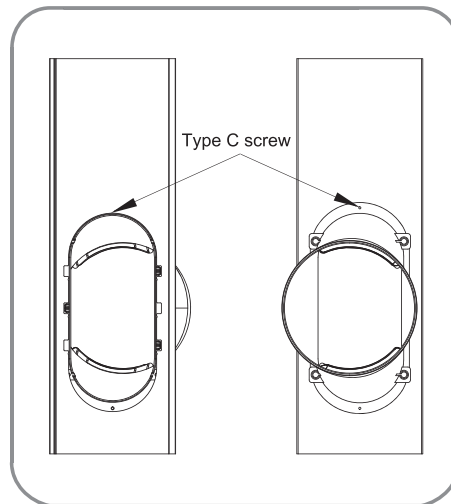

If you want fix the diffuser more firmly, use the type C screw.

CARE AND CLEANING

Your air conditioner is designed for year-round operation with only minimal cleaning and maintenance.

For maximum efficiency, it is recommended that you have the cooling coils inspected and cleaned annually. Your local LG Authorized Service Center can provide this inspection and cleaning service for a nominal fee.

⚠ WARNING

- Unplug the air conditioner before cleaning or performing any maintenance or servicing.
- Be careful when cleaning coils or removing or reinstalling the filter—the cooling fins are sharp!

Failure to follow the above precautions could result in electrical shock or personal injury.

WATER DRAINAGE

This product has a self-evaporative system. The condensing water will be recycled to cool the condenser. This can not only improve cooling efficiency, but also save energy for you.

Using the Upper Drain Port (Dry Mode Only)

- This can be used when you need dehumidification in high humidity.
- Under the Cool or Fan mode, there's no need of using the upper drain port.
- During DRY(dehumidifying) mode, remove the drain plug.
- Install a drain hose (16mm [5/8"] inside diameter) and place the open end of the hose at a suitable drain location or outdoors.

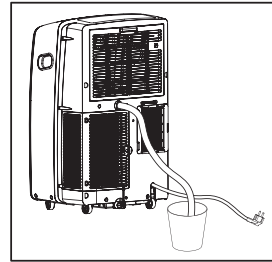
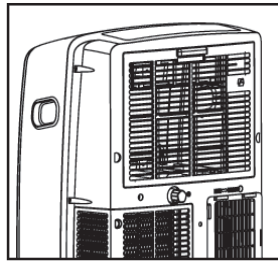

Using the Bottom Drain Port

When the internal water collection tank is full, the LED display will show E5 and the air conditioner will turn off until the tank is emptied.

- Unplug the air conditioner, disconnect the exhaust hose from the back, and move the air conditioner to a suitable drain location or outdoors. You may also place a pan under the drain that will hold up to 2 pints of water.
- Remove the drain cap from the drain outlet.
- Once the water collection tank is drained, reinstall the drain cap, making sure it is on securely.
- Place the air conditioner in the desired location, reconnect the exhaust hose, and plug in the air conditioner.

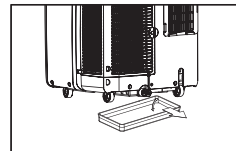

NOTICE E5 appears in the display

The water collection tank is full, drain the tank and restart the air conditioner.

NOTES: When turned on after being unplugged, the air conditioner will automatically reset to COOL mode, with a temperature setting of 75°F.

CARE AND CLEANING

ENGLISH

CLEANING THE CASE

Wipe the case with a slightly damp cloth, then wipe dry with a dry cloth or towel.

- To prevent damage to the finish, do not use gasoline, benzene, thinner, etc., or any abrasive cleansers to clean the air conditioner; they may damage the finish.
- Never pour water onto or into the air conditioner. It could damage internal components and create a shock and fire hazard.

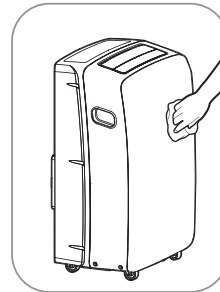

CLEANING THE AIR FILTER

The air filter should be cleaned every two weeks; depending on indoor air quality, more frequent cleaning may be needed. A dirty air filter will decrease airflow and reduce efficiency.

Do not operate the air conditioner without the air filter in place.

- 1 Pull out the air filter by the handle.
- 2 Use a vacuum cleaner to clean the filter. If the filter is heavily soiled, it can be washed in warm water using a mild detergent.
Do not use harsh cleaners or very hot water.
Do not wash in a dishwasher.
- 3 Allow the filter to dry completely before reinstalling.
- 4 Reinsert the filter.

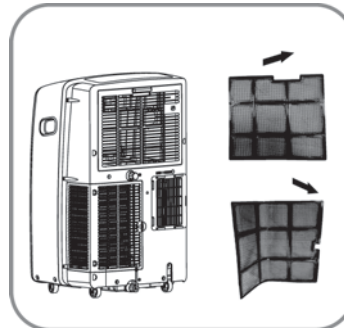

CARE AND CLEANING

STORING THE AIR CONDITIONER

If the air conditioner will not be used for an extended period of time:

- 1 To drain the water collection tank completely, leave the bottom drain cap off long enough to allow any residual water to drain out. Once the tank is completely drained and no more water flows out, reinstall the cap.
- 2 Remove and clean the filter, allow it to dry completely, then reinstall it.
- 3 Remove the batteries from the remote.
- 4 Store the air conditioner in a cool, dry location, away from direct sunlight, extreme temperatures, and excessive dust.

Before using the air conditioner again:

- 1 Make sure the filter and drain cap are in place
- 2 Check the power cord to make sure it is in good condition, with no cracks or damage.
- 3 Place new batteries in the remote.
- 4 Install the air conditioner as described in the Installation Instructions.

TROUBLESHOOTING

BEFORE CALLING FOR SERVICE

Before you call for service, review this list. It may save you time and expense. This list includes common occurrences that are not the result of a defect in workmanship or materials.

<i>Self Diagnosis</i>	<i>Possible Causes</i>	<i>What To Do</i>
Air conditioner does not start	The air conditioner is unplugged.	Make sure the air conditioner plug is pushed completely into the outlet.
	The fuse is blown/circuit breaker is tripped.	Check the house fuse/circuit breaker box and replace the fuse or reset the breaker.
	Power failure.	If power failure occurs, turn the mode control to Off. When power is restored, wait 3 minutes to restart the air conditioner to prevent tripping of the compressor overload.
	The current interrupter device is tripped.	Press the RESET button located on the power cord plug. If the RESET button will not stay engaged, discontinue use of the air conditioner and contact a qualified service technician.
	E5 appears in the display.	The water collection tank is full. Drain the tank and reset your settings.
	Room temperature is less than the set temperature.	This is normal. The air conditioner automatically shuts off when the room equals or is less than the set temperature. Adjust the temperature setting, if needed.
Air conditioner does not cool as it should	Airflow is restricted.	Make sure there are no curtains, blinds, or furniture blocking the front of the air conditioner.
	The temp control may not be set correctly.	In COOL model, press the DECREASE ▼ pad.
	The air filter is dirty.	Clean the filter at least every 2 weeks. See the Care and Cleaning section.
	The room may have been hot.	When the air conditioner is first turned on, you need to allow time for the room to cool down.
Air conditioner freezing up	The cooling coils are iced over.	Ice may block the air flow and obstruct the air conditioner from properly cooling the room. Set the mode control at High Fan or High Cool .
Air conditioner runs too often or too long	Area to be cooled is too large for the air conditioner.	Consult your dealer for the air conditioner capacity necessary to cool the desired area.
	Doors or windows are open.	Make sure doors and windows are closed.

TROUBLESHOOTING

BEFORE CALLING FOR SERVICE

<i>Self Diagnosis</i>	<i>Possible Causes</i>	<i>What To Do</i>
Code appears in the display. E5	The water collection tank is full.	Empty the water collection tank. See the Care and Cleaning section.
E1	Short or open circuit in the indoor air thermistor.	Unplug the air conditioner and contact your authorized LG service center.
E2	Short or open circuit in the indoor pipe thermistor.	Unplug the air conditioner and contact your authorized LG service center.
EA	When have software problem, display "EA"	Unplug the air conditioner and contact your authorized LG service center.

LG PORTABLE AIR CONDITIONER LIMITED WARRANTY - USA

WHAT THIS WARRANTY COVERS:

LG Electronics U.S.A., Inc. ("LG") warrants your LG Portable Air Conditioner ("product") against defect in materials or workmanship under normal household use, during the warranty period set forth below, LG will, at its option, repair or replace the product. This limited warranty is valid only to the original retail purchaser of the product, is not assignable or transferrable to any subsequent purchaser or user, and applies only when the product is purchased through an LG authorized dealer or distributor and used within the United States ("U.S.") including U.S. Territories.

Note: Replacement products and repair parts may be new or factory-remanufactured and are warranted for the remaining portion of the original unit's warranty period or ninety (90) days, whichever is longer. Please retain dated receipt or delivery ticket as evidence of the Date of Purchase for proof of warranty (you may be required to submit a copy to LG or authorized representative).

WARRANTY PERIOD:

1 year from the Date of Purchase: **Any internal/ functional Parts and Labor.**

HOW SERVICE IS HANDLED: In-Home Service

In-home service will be provided during the warranty period subject to availability within the United States. In-home service may not be available in all areas. To receive in-home service, the product must be unobstructed and accessible to service personnel. If during in-home service repair cannot be completed, it may be necessary to remove, repair and return the product. If in-home service is unavailable, LG may elect, at our option, to provide for transportation of our choice to and from a LG authorized service center.

THIS LIMITED WARRANTY DOES NOT COVER:

1. Service trips to deliver, pick up, or install the product or for instruction on product use.
2. Replacing house fuses or resetting of circuit breakers, correction of house wiring or plumbing, or correction of product installation.
3. Damage or failure caused by leaky/ broken/ frozen water pipes, restricted drain lines, inadequate or interrupted water supply or inadequate supply of air.
4. Damage or failure caused by accidents, pests and vermin, lightning, wind, fire, floods or acts of God.
5. Damage or failure resulting from misuse, abuse, improper installation, repair or maintenance. Improper repair includes use of parts not approved or specified by LG.
6. Damage or failure caused by unauthorized modification or alteration to the product.
7. Damage or failure caused by incorrect electrical current, voltage, or plumbing codes.
8. Cosmetic damage, including scratches, dents, chips or other damage to the finish of the product, unless such damage results from defects in materials or workmanship and is reported to LG within seven (7) calendar days from the date of delivery.
9. Damage or missing items to any display, open box, discounted, or refurbished product.
10. Product where the original factory serial numbers have been removed, defaced or changed in any way.
11. Repairs when product is used in other than normal and usual household use (e.g. rental, commercial use, offices, or recreational facilities) or contrary to the instructions outlined in the owner's manual.
12. The removal and reinstallation of the Product if it is installed in an inaccessible location.

THIS WARRANTY IS IN LIEU OF ANY OTHER WARRANTY, EXPRESS OR IMPLIED, INCLUDING AND WITHOUT LIMITATION TO, ANY WARRANTY OF MERCHANTABILITY OR FITNESS FOR A PARTICULAR PURPOSE. TO THE EXTENT ANY IMPLIED WARRANTY IS REQUIRED BY LAW, THIS WARRANTY IS LIMITED IN DURATION TO THE TERM PERIOD EXPRESSED ABOVE. REPAIR OR REPLACEMENT AS PROVIDED UNDER THIS WARRANTY IS THE EXCLUSIVE REMEDY FOR THE CUSTOMER. NEITHER THE MANUFACTURER NOR ITS U.S. DISTRIBUTOR SHALL BE LIABLE FOR ANY INCIDENTAL, CONSEQUENTIAL, INDIRECT, SPECIAL, OR PUNITIVE DAMAGES OF ANY NATURE, INCLUDING AND WITHOUT LIMITATION TO, LOST REVENUES OR PROFITS, OR ANY OTHER DAMAGE, WHETHER BASED IN CONTRACT, TORT, OR OTHERWISE.

SOME STATES DO NOT ALLOW THE EXCLUSION OR LIMITATION OF INCIDENTAL OR CONSEQUENTIAL DAMAGES OR LIMITATIONS ON HOW LONG AN IMPLIED WARRANTY LASTS, SO THE ABOVE EXCLUSION OR LIMITATION MAY NOT APPLY TO YOU. THIS WARRANTY GIVES YOU SPECIFIC LEGAL RIGHTS AND YOU MAY ALSO HAVE OTHER RIGHTS THAT VARY FROM STATE TO STATE.

HOW TO OBTAIN WARRANTY SERVICE & ADDITIONAL INFORMATION:

Call 1-800-243-0000 or visit our website at www.lg.com.

Mail to: LG Customer Information Center (ATTN: CIC)
201 James Record Road, Huntsville, AL 35824



LG ELECTRONICS, INC.
1000 Sylvan Ave., Englewood Cliffs, NJ 07632

LG Customer Information Center

1-800-243-0000

Register your product Online!

www.lg.com

4050661-01