



ENGLISH

FRANÇAIS

ESPAÑOL



800-570-3355

OWNER'S MANUAL

AIR CONDITIONER

Please read this manual carefully before operating your set and retain it for future reference.

TYPE : Standard / Standard Libero
Artcool Mirror
Ceiling Cassette

<http://www.lghvac.com>
www.lg.com

P/NO : MFL39817411

TABLE OF CONTENTS

A. Safety Precautions	3
B. Electrical Safety	6
Temporary Use of an Adapter	6
Symbols used in this Manual	6
C. Product Introduction	7
Indoor Units	7
Outdoor Unit	7
D. Operating Instructions	8
How to insert the Batteries	8
Wireless Remote Controller	
Maintenance.....	8
Operation Indication Lamps	9
Operating Method	9
Wireless Remote Controller	10
Wired Remote Controller (Optional) ...	12
Operation Mode	13
Healthy Dehumidification Operation	14
Air Circulation Operation	14
Auto Operation	14
PLASMA Purification Operation	
(Optional)	14
Jet Cool/Heat Operation.....	15
Energy-Saving Cooling Mode	
(Optional)	15
Display Luminosity (Optional).....	15
Sleep Mode Operation (Optional) ...	15
Auto Clean(Optional).....	16
Setting the Current Time	16
Timer Setting	16
To cancel the Timer Setting	16
Forced operation	17
Auto Restart Function	17
Horizontal Vane Control (Up/Down	
Airflow Direction Control).....	18
Vertical Louver Control (Left/Right Airflow	
Direction Control) (Optional).....	18
E. Maintenance and Service	19
Standard/Standard Libero/Artcool	
Mirror Type.....	19
Ceiling Cassette Type	20
Operation Tips!.....	21



FOR YOUR RECORDS

Write the model and serial numbers here:

Model # _____

Serial # _____

You can find them on a label on the side of each unit.

Dealer's Name _____

Date Purchased _____

■ Staple your receipt to this page in the event you need it to prove date of purchase or for warranty issues.



READ THIS MANUAL

Inside you will find many helpful hints on how to use and maintain your air conditioner properly. Just a little preventive care on your part can save you a great deal of time and money over the life of your air conditioner.

You'll find many answers to common problems in the chart of troubleshooting tips. If you review our chart of

Troubleshooting Tips first, you may not need to call for service at all.



PRECAUTION

- Contact the authorized service technician for repair or maintenance of this unit.
- Contact the installer for installation of this unit.
- The air conditioner is not intended for use by young children or invalids without supervision.
- Young children should be supervised to ensure that they do not play with the air conditioner.
- When the power cord is to be replaced, replacement work shall be performed by authorized personnel only using only genuine replacement parts.



Safety Precautions



To prevent injury to the user or other people and property damage, the following instructions must be followed.

■ Incorrect operation due to ignoring instruction will cause harm or damage. The seriousness is classified by the following indications.

⚠ WARNING This symbol indicates the possibility of death or serious injury.

⚠ CAUTION This symbol indicates the possibility of injury or damage.

■ Meanings of symbols used in this manual are as shown below.

	Be sure not to do.
	Be sure to follow the instruction.

⚠ WARNING

- Always use a power plug and socket with a ground terminal.
 - There is a risk of electric shock.
- Do not use a defective or underrated circuit breaker. Use the correctly rated breaker and fuse.
 - There is risk of fire or electric shock.
- Do not use a multi consent. Always use this appliance on a dedicated circuit and breaker.
 - Otherwise it can cause electric shock or fire.
- For electrical work, contact the dealer, seller, a qualified electrician, or an Authorized Service Center. Do not disassemble or repair the product by yourself.
 - There is risk of fire or electric shock.
- Always ground the product as per the wiring diagram. Do not connect the ground wire to gas or water pipes, lightning rod or telephone ground wire.
 - There is risk of fire or electric shock.
- Install the panel and the cover of control box securely.
 - There is risk of fire or electric shock due to dust, water etc.
- Use the correctly rated breaker or fuse.
 - There is risk of fire or electric shock.
- Do not modify or extend the power cable. If the power cable or cord has scratches or skin peeled off or deteriorated then it must be replaced.
 - There is risk of fire or electric shock.
- For installation, removal or reinstall, always contact the dealer or an Authorized Service Center.
 - There is risk of fire, electric shock, explosion, or injury.
- Do not install the product on a defective installation stand. Be sure that the installation area does not deteriorate with age.
 - It may cause product to fall.
- Never install the outdoor unit on a moving base or a place from where it can fall down.
 - The falling outdoor unit can cause damage or injury or even death of a person.
- When the product is soaked (flooded or submerged) in water, contact an Authorized Service Center for repair before using it again.
 - There is risk of fire or electric shock.
- In outdoor unit the step-up capacitor supplies high voltage electricity to the electrical components. Be sure to discharge the capacitor completely before conducting the repair work.
 - An charged capacitor can cause electrical shock.
- When installing the unit, use the installation kit provided with the product.
 - Otherwise the unit may fall and cause severe injury.
- Be sure to use only those parts which are listed in the svc parts list. Never attempt to modify the equipment.
 - The use of inappropriate parts can cause an electrical shock, excessive heat generation or fire.

Safety Precautions

Indoor/outdoor wiring connections must be secured tightly and the cable should be routed properly so that there is no force pulling the cable from the connection terminals.

- Improper or loose connections can cause heat generation or fire.

Be sure to check the refrigerant to be used. Please read the label on the product.

- Incorrect refrigerant used can prevent the normal operation of the unit.

Do not place a heater or other heating appliances near the power cable.

- There is risk of fire and electric shock.

Do not use the product in a tightly closed space for a long time. Perform ventilation regularly.

- Oxygen deficiency could occur and hence harm your health.

Ventilate the product room from time to time when operating it together with a stove, or heating element etc.

- Oxygen deficiency can occur and hence harm your health.

Take care to ensure that nobody especially kids could step on or fall onto the outdoor unit.

- This could result in personal injury and product damage.

Do not plug or unplug the power supply plug to turn the unit ON/OFF .

- There is risk of fire or electric shock.

Safely dispose off the packing materials. Like screws, nails, batteries, broken things etc after installation or svc and then tear away and throw away the plastic packaging bags.

- Children may play with them and cause injury.

Don't use a power cord, a plug or a loose socket which is damaged.

- Otherwise it may cause a fire or electrical shock.

Do not allow water to run into electric parts. Install the unit away from water sources.

- There is risk of fire, failure of the product, or electric shock.

Do not open the front grille of the product during operation. (Do not touch the electrostatic filter, if the unit is so equipped.)

- There is risk of physical injury, electric shock, or product failure.

Turn the main power off and unplug the unit when cleaning or repairing the product.

- There is risk of electric shock.

Take care to ensure that power cable could not be pulled out or damaged during operation.

- There is risk of fire or electric shock.

Make sure to check that the power cable plug is not dirty, loose or broken and then only insert the plug completely.

- Dirty, loose or broken power plug can cause electric shock or fire.

Do not touch , operate, or repair the product with wet hands. Hold the plug by hand when taking out

- There is risk of electric shock or fire.

Do not store or use or even allow flammable gas or combustibles near the product.

- There is risk of fire.

If strange sounds, smell or smoke comes from product. Immediately turn the breaker off or disconnect the power supply cable.

- There is risk of electric shock or fire.

When the product is not to be used for a long time, disconnect the power supply plug or turn off the breaker.

- There is risk of product damage or failure, or unintended operation.

Do not place ANYTHING on the power cable.

- There is risk of fire or electric shock.

When flammable gas leaks, turn off the gas and open a window for ventilation before turn the product on.

- Do not use the telephone or turn switches on or off. There is risk of explosion or fire.

CAUTION

Two or more people must lift and transport the product.

- Avoid personal injury.

Keep level even when installing the product.

- To avoid vibration or noise.

Do not install the product where it will be exposed to sea wind (salt spray) directly.

- It may cause corrosion on the product.

Do not install the product where the noise or hot air from the outdoor unit could damage or disturb the neighborhoods.

- It may cause a problem for your neighbors and hence dispute.

Install the drain hose to ensure that the condensed water is drained away properly.

- A bad connection may cause water leakage.

Always check for gas (refrigerant) leakage after installation or repair of product.

- Low refrigerant levels may cause failure of product.

Do not use the product for special purposes, such as preserving foods, works of art, etc. It is a consumer air conditioner, not a precision refrigeration system.

- There is risk of damage or loss of property.

Do not block the inlet or outlet of air flow.

- It may cause product failure.

Use a soft cloth to clean. Do not use harsh detergents, solvents or splashing water etc .

- There is risk of fire, electric shock, or damage to the plastic parts of the product.

Do not touch the metal parts of the product when removing the air filter.

- There is risk of personal injury.

Do not step on or put anything on the product. (outdoor units)

- There is risk of personal injury and failure of product.

Always insert the filter securely after cleaning. Clean the filter every two weeks or more often if necessary.

- A dirty filter reduces the efficiency.

Do not insert hands or other objects through the air inlet or outlet while the product is operating.

- There are sharp and moving parts that could cause personal injury.

Be cautious when unpacking and installing the product.

- Sharp edges could cause injury.

If the refrigerant gas leaks during the repair, do not touch the leaking refrigerant gas.

- The refrigerant gas can cause frostbite (cold burn)

Do not tilt the unit when removing or uninstalling it.

- The condensed water inside can spill .

Do not mix air or gas other than the specified refrigerant used in the system .

- If air enters the refrigerant system, an excessively high pressure results, causing equipment damage or injury.

If the refrigerant gas leaks during the installation, ventilate the area immediately.

- Otherwise it can be harmful for your health.

Dismantling the unit, treatment of the refrigerant oil and eventual parts should be done in accordance with local and national standards.

Replace the all batteries in the remote control with new ones of the same type. Do not mix old and new batteries or different types of batteries.

- There is risk of fire or product failure.

Do not recharge or disassemble the batteries. Do not dispose off batteries in a fire.

- They may burn or explode.

If the liquid from the batteries gets onto your skin or clothes, wash it well with clean water. Do not use the remote if the batteries have leaked.

- The chemicals in batteries could cause burns or other health hazards.

If you eat the liquid from the batteries, brush your teeth and see doctor. Do not use the remote if the batteries have leaked.

- The chemicals in batteries could cause burns or other health hazards.

Do not let the air conditioner run for a long time when the humidity is very high and a door or a window is left open.

- Moisture may condense and wet or damage furniture.

Do not expose your skin or kids or plants to the cool or hot air draft.

- This could harm to your health.

Do not drink the water drained from the product.

- It is not sanitary and could cause serious health issues.

Use a firm stool or ladder when cleaning, maintaining or repairing the product at an height.

- Be careful and avoid personal injury.

Electrical Safety

⚠ WARNING

- This appliance must be properly grounded.
To minimize the risk of electric shock, you must always plug into a grounded outlet.
- Do not cut or remove the grounding prong from the power plug.
- Attaching the adapter ground terminal to the wall receptacle cover screw does not ground the appliance unless the cover screw is metal and not insulated, and the wall receptacle is grounded through the house wiring.
- If you have any doubt whether the air conditioner is properly grounded, have the wall receptacle and circuit checked by a qualified electrician.

Temporary Use of an Adapter

We strongly discourage the use of an adapter due to potential safety hazards. For temporary connections, use only a genuine adapter, available from most local hardware stores. Ensure that the large slot in the adapter is aligned with the large slot in the receptacle for a proper polarity connection.

To disconnect the power cord from the adapter, use one hand on each to avoid damaging the ground terminal. Avoid frequently unplugging the power cord as this can lead to eventual ground terminal damage.

⚠ WARNING

- Never use the appliance with a broken adapter.

Symbols used in this Manual



This symbol alerts you to the risk of electric shock.



This symbol alerts you to hazards that may cause harm to the air conditioner.

NOTE

This symbol indicates special notes.

Product Introduction

Here is a brief introduction of the indoor and outdoor units. Please see the information specific to your indoor unit type.

Indoor Units

[Standard Type]

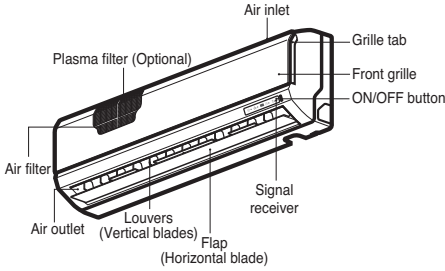

[Artcool Mirror Type]

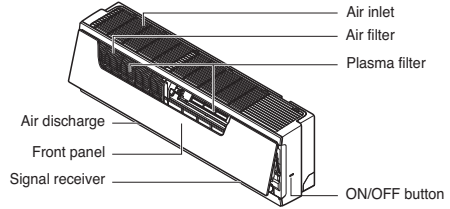

[Standard Libero Type]

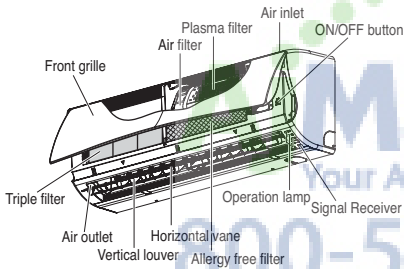

[Ceiling Cassette Type]

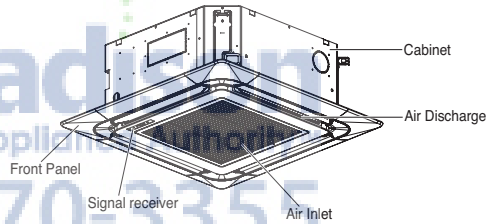

Outdoor Unit

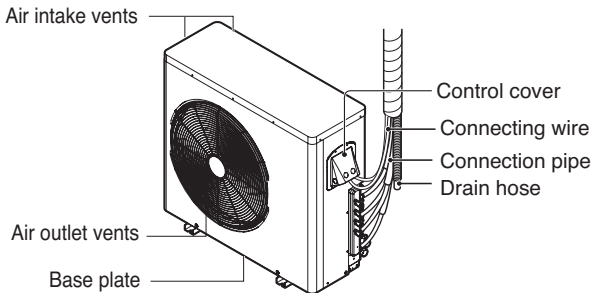

※ The figure can be changed according to model.

Operating Instructions

How to insert the Batteries

1. Remove the battery cover by pulling it according to the arrow direction.
2. Insert new batteries making sure that the (+) and (-) of battery are installed correctly.(Battery Size = AAA)
3. Reattach the cover by sliding it back into position.

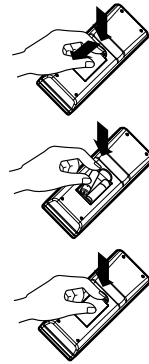

NOTE

1. Always use/replace both batteries of same type.
2. If the system is not to be used for a long time, remove the batteries to save their working life.
3. If the display screen of remote controller starts, fading replace both of the batteries.

Wireless Remote Controller Maintenance

1. Choose a suitable place where its safe & easy to reach.
2. Fix the holder to wall etc with the supplied screws firmly.
3. Slide the remote controller inside the holder.

NOTE

1. Remote controller should never be exposed to direct sunlight.
2. Signal transmitter & receiver should always be clean for proper communication. Use a soft cloth to clean them.
3. In case some other appliances also get operated with remote control, change their position or consult your serviceman.

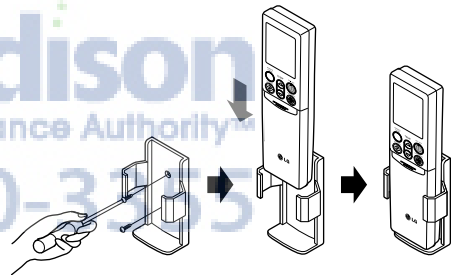

Operation Indication Lamps

[Standard/Artcool Mirror Type]

- Ⓛ On/Off : Lights up during the system operation, error code and auto restart setting.
- ☆ Sleep mode : Lights up during sleep mode auto operation.
- ⚡ Plasma : The function illustrates its dynamic mode by using a multiple lighting system.
- ⌚ Timer : Lights up during timer operation.
- * ⚡ Defrost mode : Lights up during defrost mode or *hot start operation.
- ⓁⓁ Power Display : Indicates the setting temperature and operation mode.

Operation mode	Cooling, heating, Dehumidification Mode	Jet Cool	Auto clean
Shape of display	Setting temperature	P ₀	C ₀

* Hot start operation: Stops the indoor fan in heating operation for minutes to prevent cold air from blowing out from unit.

* In defrost mode unit stops heating operation for few minutes to remove formation of ice on the heat exchanger coils to maintain the efficiency.

[Standard Libero Type]

- Cooling : 'Cooling' lamp lights up during Cooling Operation
- Heating : 'Heating' lamp lights up during Heating Operation
- Plasma : 'Plasma' lamp lights up during Plasma Purification Operation
- * During Air Circulation Operation, 'Cooling' lamp lights up.
- * While Plasma Purification operates with Air Circulation Operation, 'Cooling' lamp and 'Plasma' lamp lights up at the same time.

[Ceiling Cassette Type]

- Ⓛ On/Off : Lights up during the system operation.
- Ⓛ Filter Sign : Lights up after 2400 hours from the time of first operating unit.
- ⌚ Timer : Lights up during Timer operation.
- * ⚡ Defrost Mode : Lights up during Defrost Mode or Hot Start operation.(Heat pump model only)
- Forced : To operate the unit when the remote control can't be used for any reason.

Operating Method

1. The signal receiver is inside the unit.
2. Aim the remote controller towards the unit to operate it.
There should not be any blockage in between.

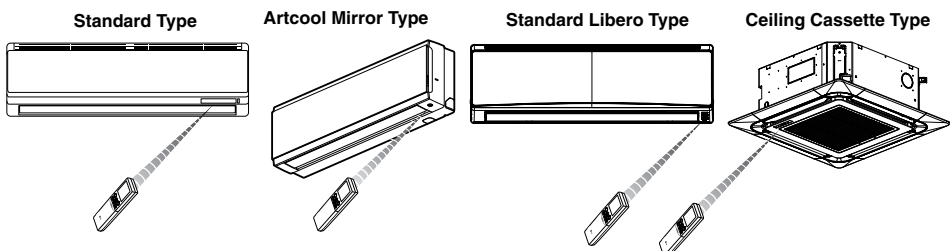

Wireless Remote Controller

[Standard / Artcool Mirror / Ceiling Cassette Type]

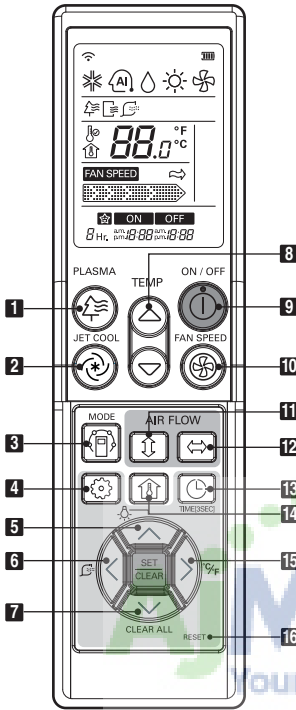

- 1 PLASMA Button (Optional)**
Used to start or stop the plasma-purification function.
- 2 JET COOL Button**
Speed cooling operates super high fan speed.
- 3 OPERATION MODE SELECTION Button**
Used to select the operation mode.
- 4 FUNCTION SETTING Button**
Used to set or clear Auto Clean or Smart Clean.
- 5 LCD LUMINOSITY Button (Optional)**
Used to adjust LCD luminosity
- 6 SMART CLEAN Button (Optional)**
Used to start or stop Smart Clean.
- 7 CLEAR ALL Button**
Used to clear all timer.
- 8 ROOM TEMPERATURE SETTING Button**
Used to select the room temperature.
- 9 ON/OFF Button**
Used to turn on/off the unit.
- 10 INDOOR FAN SPEED SELECTION Button**
Used to select fan speed in four steps low, medium, high and chaos.
- 11 UP/DOWN AIRFLOW Button**
Used to stop or start louver movement and set the desired up/down airflow direction.
- 12 LEFT/RIGHT AIRFLOW Button(Optional)**
Used to set the desired left/right(horizontal) airflow direction.
- 13 TIMER AND TIME SETTING Button**
Used to set the time of starting or stopping and sleeping operation.
- 14 ROOM TEMPERATURE CHECKING Button**
Used to check the room temperature.
- 15 °C/°F SWITCH Button**
Used to switch temperature reading from Celsius to Fahrenheit.
- 16 RESET Button**
Used to reset the remote controller.

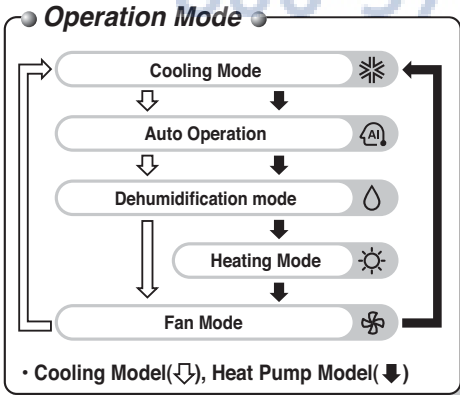

NOTE

* Some functions may not be operated and displayed depending on the product type.

[Standard Libero Type]

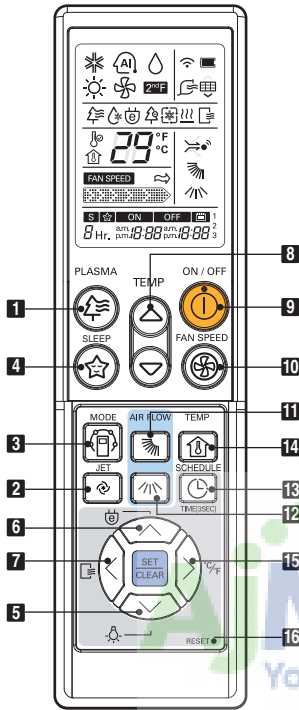

- 1 PLASMA Button**
Used to start or stop the plasma-purification function.
- 2 JET COOL Button**
Speed cooling operates super high fan speed.
- 3 OPERATION MODE SELECTION Button**
Used to select the operation mode.
- 4 SLEEP MODE AUTO Button**
Used to set sleep mode auto operation.
- 5 LED LUMINOSITY Button**
Used to adjust LCD/LED luminosity
- 6 ENERGY SAVING COOLING Button**
Used to save Energy.
- 7 AUTO CLEAN Button**
Used to set auto clean.
- 8 ROOM TEMPERATURE SETTING Button**
Used to select the room temperature.
- 9 ON/OFF Button**
Used to turn on/off the unit.
- 10 INDOOR FAN SPEED SELECTION Button**
Used to select fan speed in four steps low, medium, high and chaos.
- 11 HORIZONTAL VANE CONTROL Button**
Used to set the desired vertical airflow direction.
- 12 VERTICAL LOUVER CONTROL Button**
Used to set the desired horizontal airflow direction.
- 13 TIMER AND TIME SETTING Button**
Used to set the time of starting or stopping and sleeping operation.
- 14 ROOM TEMPERATURE CHECKING Button**
Used to check the room temperature.
- 15 °C/°F SWITCH Button**
Used to switch temperature reading from Celsius to Fahrenheit.
- 16 RESET Button**
Used to reset the remote controller.

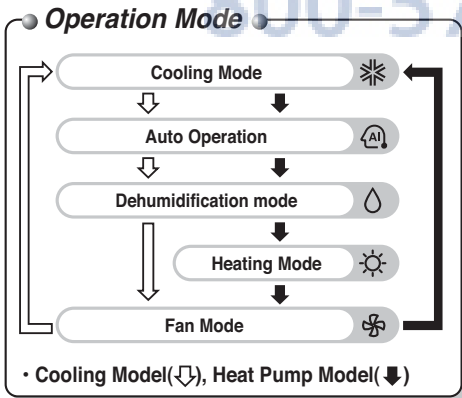



NOTE

* Some functions may not be operated and displayed depending on the product type.

Wired Remote Controller (Optional)

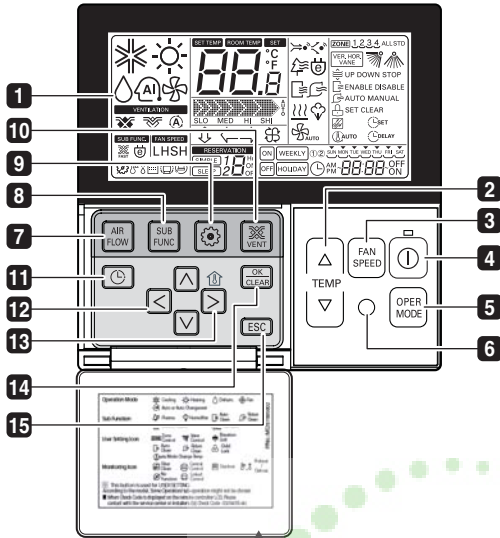
※ Model : PQRCVSL0, PQRCVSL0QW



- 1 OPERATION INDICATION SCREEN**
- 2 SET TEMPERATURE BUTTON**
- 3 FAN SPEED BUTTON**
- 4 ON/OFF BUTTON**
- 5 OPERATION MODE SELECTION BUTTON**
- 6 WIRELESS REMOTE CONTROLLER RECEIVER**
 - Some products don't receive the wireless signals.
- 7 AIR FLOW BUTTON**
- 8 SUBFUNCTION BUTTON**
- 9 FUNCTION SETTING BUTTON**
- 10 VENTILATION BUTTON(OPTIONAL)**
- 11 RESERVATION**
- 12 UP,DOWN,LEFT,RIGHT BUTTON**
 - To check the indoor temperature, press  button.
- 13 ROOM TEMPERATURE BUTTON**
- 14 SETTING/CANCEL BUTTON**
- 15 EXIT BUTTON**

Please attach the inform label inside of the door.
Please choose proper language depend on your country.

NOTE

- ※ Display temperature can be different from actual room temperature if the remote controller is installed at the place where sun-rays are falling directly or the place nearby heat source.
- ※ The actual product can be different from above contents depending upon model type.

Operation Mode

- 1** Press the ON/OFF BUTTON to turn the unit on.
The unit will respond with a beep.



- 2** Open the door of the remote controller and press the operation mode button. Each time the button is pressed, the operation mode is shifted in the direction of the arrow.



- 3** For cooling or heating operation set the desired indoor temperature by pressing the ROOM TEMPERATURE SETTING BUTTONS.
For cooling the temperature can be set within 18°C~30°C(64°F~86°F) and for heating the temperature range is 16°C~30°C(60°F~86°F).



To raise the temperature

To lower the temperature

- 4** Set the fan speed with the remote controller. You can select the fan speed by pressing the INDOOR FAN SPEED SELECTOR BUTTON.
Each time the button is pressed, the fan speed mode is shifted.



[Standard / Artcool Mirror Type]

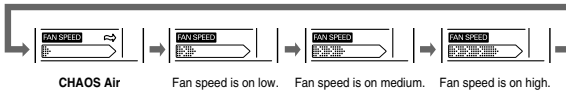

[Standard Libero Type]

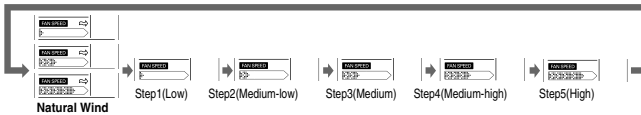

Natural wind

- For fresher feeling, press the INDOOR FAN SPEED SELECTOR BUTTON selector and set to CHAOS or Natural wind mode. In this mode, the wind blows like a natural breeze by automatically changing fan speed.

Healthy Dehumidification Operation

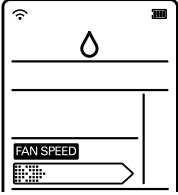

During Healthy Dehumidification Operation

❑ If you select the dehumidification mode on the OPERATION MODE SELECTION BUTTON, the product starts to run the dehumidification function. It automatically sets the room temperature and airflow volume to the best condition for dehumidification, based on the sensed current room temperature.



In this case, however, the setting temperature is not displayed on the remote controller and you are not able to control the room temperature either.

❑ During the healthy dehumidification function, the airflow volume is automatically set according to the optimization algorithm responding to the current room temperature status, so that the room condition is kept healthy and comfortable even in the very humid season.

Air Circulation Operation

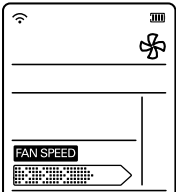

This operation circulates the air without cooling or heating. It can be activated by pressing the OPERATION MODE SELECTION BUTTON. Once the air circulation is activated you can select the air speed by pressing the INDOOR FAN SPEED SELECTOR BUTTON.



NOTE : During this operation, 'Cooling' lamp lights up.
(Standard Libero Type)

Auto Operation

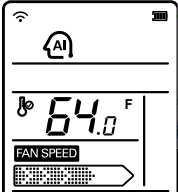

In this operation mode, the system is automatically operated by the electronic controls.

- You can set the desired temperature between 64°F and 86°F for Auto Operation mode.

NOTE

This function properly operates when you use the remote controller matching each model.



PLASMA Purification Operation (Optional)

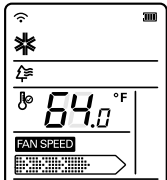

Plasma filter is a technology developed by LG to get rid of microscopic contaminants in the intake air by generating a plasma of high charge electrons. This plasma kills and destroys the contaminants completely to provide clean and hygienic air.

Plasma purification can be started by pressing the PLASMA BUTTON on the remote controller. Repeating it will deactivate the operation.

NOTE

This feature can be used in any operation mode and any fan speed can be used while plasma filter is functioning.



Jet Cool/Heat Operation

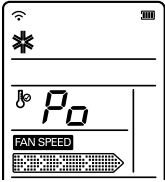

Jet cool function can be used to cool the room quickly in hot summer. When this function is turned on, the air conditioner runs in cooling operation mode with super high fan speed and 18°C(64°F) setting temperature for 30 minutes for fast and effective cooling.

Similarly, jet heat function (available only in some models) warms up the room quickly by operating at super high fan speed and 30°C(86°F) setting temperature for 30 minutes.

You can activate this operation by pressing the JET COOL BUTTON.

To change from jet cool mode to high fan speed cooling mode, press the JET COOL BUTTON or INDOOR FAN SPEED SELECTOR BUTTON or the ROOM TEMPERATURE SETTING BUTTON again.



NOTE

• Jet Cool/Heat operation cannot be activated during Air Circulation operation and auto operation.

Energy-Saving Cooling Mode (Optional)

Energy-saving cooling mode can save energy in cooling operation, because it can operate efficiently by setting body-adaptation time according to the change of time and temperature and adjusting desired temperature automatically.

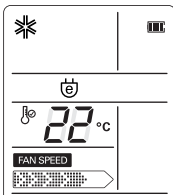

1. Press the ON/OFF BUTTON to start the unit.
2. Open the cover of the remote controller.
Select cooling operation.
3. Press the ENERGY-SAVING COOLING MODE BUTTON.
4. To cancel the energy-saving cooling mode, press the ENERGY-SAVING COOLING MODE BUTTON again and unit will operate in previous mode(Cooling mode).



Display Luminosity (Optional)

The Display Luminosity can be adjusted by using the remote control.

Open the cover of the remote controller, and press the LCD/LED LUMINOSITY button. Display will be dark. Press the button again to set bright display.



Sleep Mode Operation (Optional)

Press the SLEEP MODE AUTO BUTTON to set the time when you want the unit to stop automatically. The timer is programmed in one-hour increments by pressing the SLEEP MODE AUTO BUTTON 1 to 7 times. The sleep mode is available for 1 to 7 hours.



NOTE

• The sleep mode will operate indoor fan at super low speed in cooling mode and at low speed in heating mode for pleasant sleep.



Auto Clean(Optional)

- During auto clean function, moistures left in indoor units after cooling operation or healthy dehumidification operation can be removed.

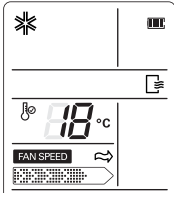
This function operate when the unit is turned off.



[Standard / Artcool Mirror / Ceiling Cassette Type]

1. Press the FUNCTION SETTING button 1 time. 
Auto Clean symbol will blink. 
2. Press the SET/CLEAR button to reserve or cancel the Auto Clean function. 

[Standard Libero Type]

- Press the Auto Clean button. 

If the Auto Clean function is reserved, whenever the unit is turned off, the indoor fan is still running for about 30 minutes internally without cooling or dehumidification operation. Also the louver is closed.

This dries up any remains of moisture & cleans the unit internally.



Setting the Current Time

1. Press the TIMER button for 3 seconds. 
2. Press TIME SETTING buttons until the desired time is set. 
3. Press the SET / CLEAR button. 

NOTE

Check the indicator for A.M. and P.M.

Timer Setting

1. Press the TIMER button to turn timer on or off. 
2. Press TIME SETTING buttons until the desired time is set. 
3. Press the SET / CLEAR button. 

To cancel the Timer Setting

- If you wish to cancel all timer setting, press the CLEAR ALL or SET/CLEAR button.
- If you wish to cancel each timer setting, press the TIMER button to turn timer sleep or on or off as you want. And then press the SET/CLEAR button aiming the remote controller at the signal receptor.
(The timer lamp on the air conditioner and the display will go off.)

Forced operation

Forced operation is used when the remote controller can't be used. The operation will be started if the ON/OFF button is pressed. If you want to stop the operation, re-press the button.

[Artcool Mirror Type]

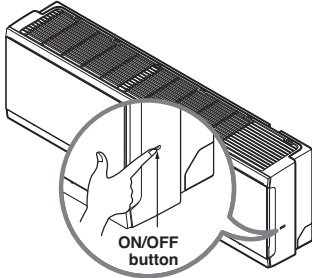

[Standard Type]

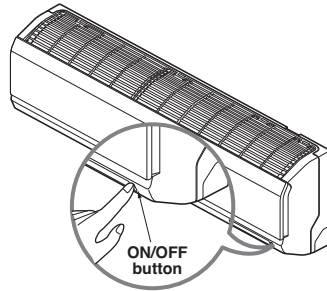

[Standard Libero Type]

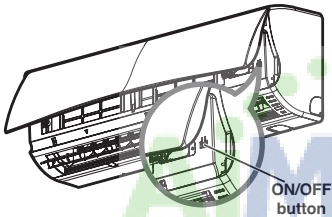

[Ceiling Cassette Type]

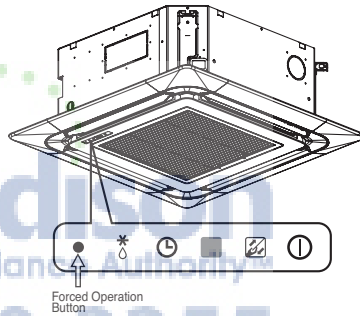

Heat pump Model			
	Room Temp. $\geq 24^{\circ}\text{C}(75.2^{\circ}\text{F})$	$21^{\circ}\text{C}(69.8^{\circ}\text{F}) \leq \text{Room Temp.} < 24^{\circ}\text{C}(75.2^{\circ}\text{F})$	Room Temp. $< 21^{\circ}\text{C}(69.8^{\circ}\text{F})$
Operating mode	Cooling	Healthy Dehumidification	Heating
Indoor FAN Speed	High	High	High
Setting Temperature	$22^{\circ}\text{C}(71.6^{\circ}\text{F})$	$23^{\circ}\text{C}(73.4^{\circ}\text{F})$	$24^{\circ}\text{C}(75.2^{\circ}\text{F})$

Test operation

During the TEST OPERATION, the unit operates in cooling mode at high speed fan, regardless of room temperature and resets in 18 minutes. During test operation, if remote controller signal is received, the unit operates as remote controller sets. If you want to use this operation, Press and hold the ON/OFF button for 3~5 seconds, then the buzzer sound 1 'beep'. If you want to stop the operation, re-press the button.

Auto Restart Function

This function is useful in the situation of power failure. When power regains after a failure this feature restore the previous operating condition and the air conditioner will run in the same settings.

NOTE

This feature is enabled by factory default setting, but you can disable it by pressing the ON/OFF button for 6 seconds. The unit will beep twice and the lamp will blink 8 times. To enable it, press the button again for 6 seconds. The unit will beep twice and the blue lamp will blink 4 times.

Horizontal Vane Control (Up/Down Airflow Direction Control)

The Horizontal Vane can be adjusted by using the remote controller.

[Standard / Artcool Mirror / Ceiling Cassette Type]

1. Press the ON/OFF button to start the unit. 
2. Press UP/DOWN AIRFLOW button and the louvers will swing up and down.
Press the UP/DOWN AIRFLOW button again to set the vertical louver at the desired airflow direction.

[Standard Libero Type]

1. Press the ON/OFF BUTTON to start the unit.
2. Press the vertical airflow direction button.
Each time the button is pressed, the air-flow direction is changed in the direction of the arrow. 



※ Press the Vertical Airflow Direction button once more during Auto Swing at the direction of airflow you want.

Vertical Louver Control (Left/Right Airflow Direction Control) (Optional)

The Vertical Louvers can be adjusted by using the remote controller.

[Standard / Artcool Mirror / Ceiling Cassette Type]

1. Press the ON/OFF button to start the unit.
 2. Press the LEFT/RIGHT AIRFLOW button and the louvers will swing left and right.
Press the Horizontal Airflow Direction Control Button again to set the horizontal louver at the desired airflow direction.
- ※ Up/Down and Left/Right Airflow function isn't shown on display of remote controller. 

[Standard Libero Type]

1. Press the ON/OFF BUTTON to start the unit.
2. Press the horizontal airflow direction button. Each time the button is pressed, the airflow direction is changed in the direction of the arrow. 

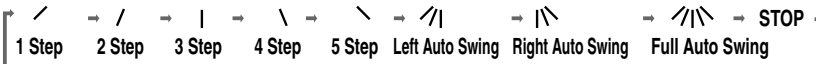

※ Press the Horizontal Airflow Direction button once more during Full Auto Swing at the direction of airflow you want.

NOTE

- Manually moving the Horizontal Vane or Vertical Louvers by hand could damage the mechanism. When the unit is shut off, the Horizontal Vane and Vertical Louvers will close the air outlet vent of the product.
- Air Conditioner memorizes the last operated angle.
So there is possibility of difference in the angle of Remote Controller and the unit after reoperation.
In that case, angle can be adjusted by pressing the Vane Control Button on the Remote Controller.
- The vertical louvers may automatically move for a specific temperature zone at the cooling mode (Standard Libero Type)
ex) 1 Step → 2 Step, 5 Step → 4 Step

Maintenance and Service

⚠ CAUTION

Before performing any maintenance, turn off the main power to the system, disconnect the circuit breaker and unplug the power cord.

Standard/Standard Libero/Artcool Mirror Type

Clean the unit with a soft dry cloth. Do not use bleach or abrasives.

⚠ CAUTION

- Never use any of these
 - Water hotter than 40°C(104°F). It may cause deformation and discoloration.
 - Volatile substances. They may damage the surface of the air conditioner.

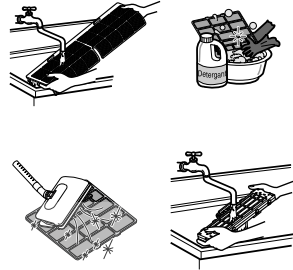

Air Filters

The air filters behind the front panel / grill should be checked and cleaned once in every 2 weeks or more often if necessary. To remove the filters see the self explanatory diagrams for each model type. Clean the filters with a vacuum cleaner or warm soapy water. If dirt is not easily removed, wash with a solution of detergent in luke warm water. Dry well in shade after washing and reinstall the filters back in place.

Plasma Filters

The plasma filters behind the air filter should be checked and cleaned once in every 3 months or more often if necessary. To remove the filters see the self explanatory diagrams for each model type. Clean the filters with a vacuum cleaner. If it is dirty wash it with water and dry well in shade an install back in place.

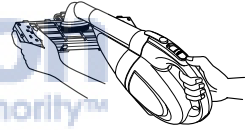

Deodorizer Filters or Allergy Free Filter + Triple Filter

Remove the deodorizer filter or allergy free filter + triple filter behind the air filter and expose them in direct sunlight for 2 hours. And then insert these filters into original position.

Removal of Filters

Open the front panel as shown. Then pull the filter tab slightly forward to remove the air filter. After removing the air filter remove the plasma and deodorizer filter by slightly pulling forward.

[Artcool Mirror Type]

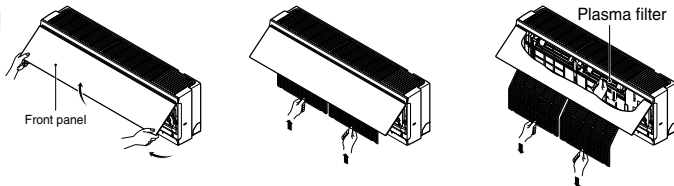

[Standard Type]

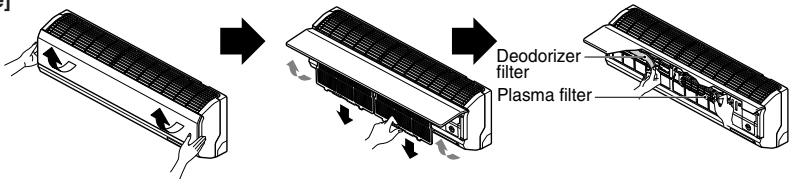

[Standard Libero Type]

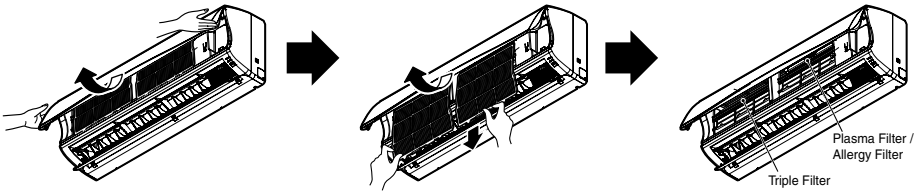

⚠ CAUTION

Don't touch this plasma filter within 10 seconds after opening the inlet grille, it may cause an electric shock.

How to use the front panel [Artcool Mirror Type]

1. Front panel closing

Move the link upward and close the front panel.

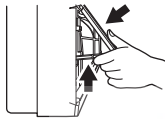

2. Front panel removing

Raise the link up to hook hanger and remove front panel forward.

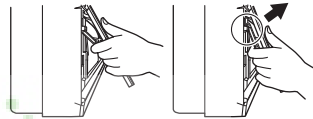

Ceiling Cassette Type

Grille, Case and Remote Control

□ Turn the system off before cleaning. To clean, wipe with a soft, dry cloth. Do not use bleach or abrasives.

NOTE

Supply power must be disconnected before cleaning the indoor unit.

Air Filters

The air filters behind the front grille should be checked and cleaned once every 2 weeks or more often if necessary.



■ Never use any of the followings:

- Water hotter than 40°C.
Could cause deformation and/or discoloration.
- Volatile substances.
Could damage the surfaces of the air conditioner.



1 Remove the Air filters.

- Take hold of the tab and pull slightly forward to remove the filter.



CAUTION: When the air filter is to be removed, do not touch the metal parts of the indoor unit. It may cause an injury.

2 Clean dirt from the air filter using a vacuum cleaner or washing with water.

- If dirt is conspicuous, wash with a neutral detergent in lukewarm water.
- If hot water (50°C or more) is used, it may be deformed.

3 After washing with water, dry well in the shade.

- Do not expose the air filter to direct sunlight or heat from a fire when drying it.

4 Install the air filter.

Operation Tips!

Do not overcool the room.

This is not good for the health and wastes electricity.

Keep blinds or curtains closed.

Do not let direct sunshine enter the room when the air conditioner is in operation.

Keep the room temperature uniform.

Adjust the vertical and horizontal airflow direction to ensure a uniform temperature in the room.

Make sure that the doors and windows are shut tight.

Avoid opening doors and windows as much as possible to keep the cool air in the room.

Clean the air filter regularly.

Blockages in the air filter reduce the airflow and lower cooling and dehumidifying effects. Clean at least once every two weeks.

Ventilate the room occasionally.

Since windows are kept closed, it is a good idea to open them and ventilate the room now and then.

Use high fan speed for effective and fast cooling.

The unit gives its rated cooling capacity when the fan speed is high.







LGEUS
 LG Electronics, Air conditioning Division
 1000 Sylvan Ave., Englewood Cliffs, NJ 07632

LGECI
 LG Electronics Canada Inc.
 550 Matheson Blvd. East, Mississauga, Ontario, L4Z 4G3

LG Customer Information Center	
888-865-3026	USA, press #2 for PTAC, TTW
888-865-3026	USA, press #3 for DFS, Multi V
1-888-LG-Canada	CANADA
Register your product Online!	
www.lge.com	



US	1. Please call the installing contractor of your product, as warranty service will be provided by them. 2. If you have service issues that have not been addressed by the contractor, please call 1-888-865-3026.
CANADA	Service call Number # : (888) LG Canada, (888) 542-2623