



LG
Life's Good

ART COOL GALLERY WALL MOUNTED OWNER'S MANUAL

AjMadison
Your Appliance Authority™
800-570-3355



Art Cool Gallery Wall Mounted
3/4 Ton and 1 Ton

PROPRIETARY DATA NOTICE

This document, as well as all reports, illustrations, data, information, and other materials is the property of LG Electronics U.S.A., Inc., and are disclosed by LG Electronics U.S.A., Inc., only in confidence.

This document is for design purposes only.

800-570-3355

DFS-OL-AK-001-US_014C07

For continual product development, LG Electronics U.S.A., Inc., reserves the right to change specifications without notice.



©LG Electronics U.S.A., Inc.

TABLE OF CONTENTS

SAFETY INSTRUCTIONS	4-6	Advanced Functions	14-15
UNIT PARTS	7	<i>Jet Cool/Heat Operation</i>	
UNIT OPERATION	8-11	<i>Air Purification Operation</i>	
<i>Single Zone Art Cool Gallery</i>		<i>Energy Saving Operation</i>	
<i>Remote Control</i>		<i>Automatic Restart</i>	
Basic Functions	12-13	MAINTENANCE	16-17
		<i>Indoor Unit - Cleaning Interval</i>	
		<i>Cleaning the Air Filter</i>	
		TROUBLESHOOTING	18-19



TABLE OF SYMBOLS

 WARNING	<i>This symbol indicates a potentially hazardous situation which, if not avoided, may result in death or serious injury.</i>
Note	<i>This symbol indicates additional helpful information such as an explanation, a comment, or a clarification about the subject.</i>
	<i>This symbol indicates a recommendation or tip. Recommendations instruct the user to apply the suggested practice to ensure the best operating results in order to achieve the maximum benefit of the product. Tips contain practical information that may help the user solve a problem or describe actions that may save time.</i>

SAFETY INSTRUCTIONS

Single Zone Art Cool Gallery

IMPORTANT!

- Please read this manual completely before operation of the product.
- Follow the instructions in this manual to prevent product malfunction, property damage, injury or death to the user or other people. Incorrect operation due to ignoring any instructions will cause harm or damage.
- The level of seriousness is classified by the symbols described below.

WARNING

This symbol indicates a potentially hazardous situation which, if not avoided, may result in death or serious injury.

Note:

This symbol indicates additional helpful information such as an explanation, a comment, or a clarification about the subject.



This symbol indicates a tip or recommendation.

Recommendations instruct the user to apply the suggested practice to ensure the best operating results in order to achieve the maximum benefit of the product.

Tips contain practical information that may help the user solve a problem or describe actions that may save time.

General Safety

WARNING

- Installation and repair must always be done by a qualified technician.
- Installation **MUST** conform with local building codes or, in the absence of local codes, with the Nation Electrical Code NFPA 70/ANSI C1-1003 or current edition and Canadian Electrical Code Part1 CSA C.22.1.
- Failure to carefully read and follow all instructions in this manual may result in equipment malfunction, property damage, personal injury and/or death.

Power and Electrical Safety

WARNING

- Immediately disconnect the product in the event of a blackout or thunderstorm. Failure to do so may result in fire, electric shock and/or damage.
- Always insure proper equipment ground. Failure to do so may result in electric shock and/or product failure.
- Be sure a circuit breaker is installed before using the air conditioner. Failure to do so may result in electric shock and/or product failure.
- Do not connect the ground wire to a gas pipe, a lightning rod or a telephone ground wire; because it may result in electric shock and/or product failure.
- Use a standard circuit breaker and fuse conforming to the rating of the air conditioner. Failure to do so may result in electric shock and/or product failure.
- Do not modify or extend the power cable; because it may result in electric shock and/or fire. If the power cable shows wear, such as scratches or outer skin peeling off or deteriorated, then it must be replaced.
- Do not use a damaged power cord; because it may result in electric shock and/or fire.
- Do not touch, operate or repair the air conditioner with wet hands.; because it may result in electric shock or product failure.
- Do not place a heater or other heat generating appliances near the power cable; because it may result in electric shock and/or fire.
- Check that the power cord is not pulled or damaged while the air conditioner is operating. Failure to do so may result in electric shock, electric shock and/or fire.
- Do not place any objects on the power cord; because it may result in electric shock or product failure.

SAFETY INSTRUCTIONS

Single Zone Art Cool Gallery

Installation Safety Instructions

⚠ WARNING

- Do not install the air conditioners on an unstable surface or where there is a danger of it falling; because it may result in death, serious injury, and/or product failure.
- Contact an authorized service center when you install or relocate the air conditioner. Failure to do so may result in serious injury and/or product failure.
- Indoor/outdoor wiring connections must be secured tightly and the cable should be routed properly so that there is no force pulling the cable from the connection terminals. Improper or loose connections may cause heat generation or fire.
- Install the panel and the cover of the control box safely. Failure to do so may result in explosion or fire.
- Do not install the air conditioner near a place with a danger of explosion or fire; because it may result in explosion or fire which may result in serious bodily injury or death.
- Ensure that the pipe and the power cable which connect the indoor unit and the outdoor unit are not pulled tight when installing the air conditioner. Failure to do so may result in electric shock or product failure.
- Do not mix air or gas in the system except for the specific refrigerant. If air enters the refrigerant system, it may result in excessively high pressure that may lead to personal injury or damage to the equipment.
- Safely dispose of packing materials such as screws, nails or batteries in a packing bag after installation or repair. Failure to do so may result in serious bodily injury.
- Do not install air conditioner with direct exposure to sea water or sea wind (salt spray) directly; because it may result in product failure.
- Install the drain hose properly for smooth drainage of condensed water. Failure to do so may result in product failure.
- Use caution when unpacking or installing the air conditioner. Failure to do so may result in bodily injury or product failure.
- When lifting or transporting the equipment, there should be 2 or more people, or a forklift. Failure to do so may result in bodily injury.
- Avoid exposure to leaking refrigerant which may occur during installation or repair. Failure to do so may result in personal injury and/or product failure.
- If there is a refrigerant leak during the installation of the air conditioner, ventilate the area immediately. Failure to do so may result in serious injury and/or product failure.

Usage

⚠ WARNING

- Use only those parts which are listed in the service parts list. Never attempt to modify the equipment; because that may result in death, serious injury, and/or product failure.
- Discard the batteries in a safe manner and where there is no danger of excessive heat or fire. Failure to do so may result in explosion or fire.
- Contact an authorized service center when the air conditioner is submerged into water due to flooding. Failure to do so may result in explosion or fire.
- Only use components that are approved by the manufacturer and do not repair or modify them; because that may result in electric shock and/or product failure.
- Only use the refrigerant specified on the air conditioner label. Failure to do so may result in explosion or fire.
- Do not allow water to run into the air conditioner; because it may result in explosion or fire.
- Do not leave flammable substances such as gasoline, benzene and other white spirits or solvents, including thinner near the air conditioner because; it may result in explosion or fire and may result in bodily injury.
- Do not use the air conditioner for an extended period of time in a small place without ventilation; because it may result in explosion or fire. Make sure to ventilate the space regularly.
- Do not touch the electrostatic filter after opening the front grill; because it may result in electric shock or product failure.
- For inner cleaning, contact an Authorized Service Center or a dealer. Do not use harsh detergent that causes corrosion or damage on the unit; because it may cause product failure, fire, and/or electronic shock.
- Disconnect power if there is a noise, smell or smoke coming from the air conditioner. Failure to do so may result in explosion or fire.
- Ventilate room or area when air conditioner and a heating appliance such as a heater are used simultaneously. Failure to do so may result in fire, serious injury, and/or product failure.
- Make sure that children do not climb up the outdoor unit or impact it. Failure to do so may result in death, bodily injury and/or product failure.
- If there is a gas leak, ventilate area sufficiently before using the air conditioner again. Failure to do so may result in explosion or fire.
- Do not use the product for special purposes, such as preserving foods, works of art, etc.; because it may result in death, fire and/or electric shock. The product is a consumer air conditioner, not a precision refrigeration system.
- Do not block the inlet or outlet of air flow; because it may result in explosion or product failure.

SAFETY INSTRUCTIONS

Single Zone Art Cool Gallery

Usage (Continued)

⚠ WARNING

- Do not insert hands or other objects through the air inlet or outlet while the air conditioner is operating; because it may result in personal bodily injury or electric shock.
- Do not expose people, animals or plants to the cold or hot wind from the air conditioner; because it may result in serious injury.
- Do not drink the water drained from the air conditioner; because it may result in serious health complications.
- During maintenance, be sure to turn the main power off when cleaning or repairing the air conditioner. Failure to do so may result in death, serious bodily injury, and/or product failure.
- Remove the batteries when the remote control is not in use for an extended period of time. Failure to do so may result in product failure.
- Filter must be installed before operating the air conditioner. Failure to do so may result in product failure.
- Do not place any objects on the air conditioner; because it may result in product failure.
- Follow the standards of the corresponding region or country for handling the refrigerant and the air conditioner, and for disassembling the air conditioner. Failure to do so may result in product failure.
- Do not mix the batteries for the remote control with other types of batteries or mix new batteries with used batteries; because it may result in product failure.
- Do not recharge or disassemble the batteries; because it may result in explosion, fire or serious bodily injury.
- Do not dispose of the batteries in fire. It may result in explosion or fire.
- Stop using the remote control if there is a battery fluid leak; and if your clothes or skin is exposed to the battery fluid from a leak, wash it off with clean water. Failure to do so may result in serious bodily injury.
- Do not let the air conditioner run for a long time when the humidity is very high or when a door or window has been left open; because it may result in product failure.

Maintenance

⚠ WARNING

- Do not use strong cleaning agents or solvents when you clean the air conditioner, or spray water; because it may result in serious bodily injury or product failure. Make sure to use a smooth cloth when cleaning the product.
- Never touch the metal parts of the air conditioner when removing the air filter; because it may result in serious bodily injury or product failure.
- Use a sturdy stool or ladder when cleaning, maintaining or repairing the air conditioner at a height. Failure to do so may result in serious bodily injury or product failure.



AiMadison
800-570-3335

UNIT PARTS

Single Zone Art Cool Gallery

The following table shows the available outdoor and indoor units, their model numbers, along with the factory provided controller.

Table 1: Single Zone Art Cool Gallery Parts

Outdoor Unit Model/ Btu/h	Indoor Unit Model/ Btu/h	Controller
LAU090HVP / 9,000 LAU120HVP / 12,000 	LAN090HVP / 9,000 LAN120HVP / 12,000 	AKB73635607 



UNIT OPERATION













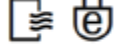













Single Zone Art Cool Gallery

Remote Control

Basic Remote Control Operation

The Single Zone Art Cool Gallery comes equipped with a remote control, enabling convenient air conditioner operation. Table 2 below describes basic button functionality, along with the displayed icon/symbol that will appear on the screen. Figure 1 shows the display screen and placement of the buttons on the Remote Control.

Table 2: Remote Control Operation

Control Panel	Display Screen	Description
		Air Circulation Button* : Used to circulate the room air without cooling or heating.
		Auto Cleaning/Energy Saving Buttons* : Sets time related to special functions such as automatic cleaning  and placing the unit into energy efficient cooling mode  .
	N/A	On/Off Button : Turns the remote control power on/off.
		Temperature Adjustment Buttons : Press up or down “arrow” temp buttons to adjust temperature during cooling or heating. Display screen will show adjusted temperature.
		Operation Mode Selection Button : Cycles through the operation mode, from top left symbols: Cooling mode:  Auto operation or auto changeover:  Dehumidifying mode:  Heating mode: 
		Fan Speed Button : Adjusts the indoor fan speed by pressing repeatedly. Also allows for natural air circulation (when wavy arrow is displayed).
		Jet Button (Heating/Cooling)* : Rapid heating or cooling of indoor temperature. Temperature heats or cools in a short period of time.
		Air Flow Direction (Swing) Buttons : Adjusts the directions of air flow; vertically or horizontally through louvres.
	-	Light Button : Adjusts the brightness of the indoor unit display.
		Room Temperature Display Button : Displays the current room temperature. Temperature value can be changed from °C or °F when button is pressed and held for 5 seconds.
		Sleep Mode Auto Button* : Pressing will activate sleep mode timer selection. Pressing the  allows you to select up to 7 hours prior to the unit automatically turning off.

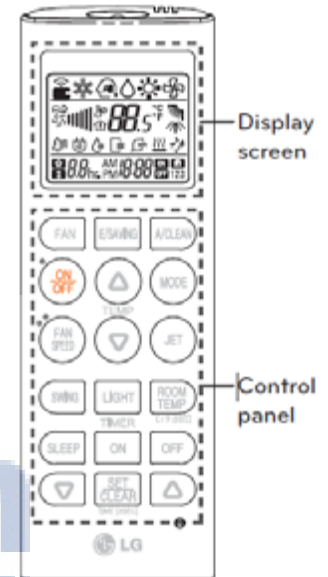

Figure 1: Single Zone Art Cool Gallery Remote Control - Model AKB73635607









* Depending on the Single Zone Wall Mounted Model used, some functions may not be supported.

UNIT OPERATION

Remote Control

Single Zone Art Cool Gallery

Table 2: Remote Control Operation (Continued)

Control Panel	Display Screen	Description
		<p>Timer Buttons (On/Off): Sets the clock timer to enable automatic start and stop times for air conditioner activity.</p> <p>Pressing the   enables the user to set the actual time as shown on the display screen.</p>
	N/A	<p>Set/Clear Button: Either sets (commits) a function or clears (cancels) a function.</p> <p>When pressing and holding for 3 seconds or longer, allows the user to set current time by using the   buttons.</p>
	N/A	<p>Up/Down (Directional) Buttons: Used in conjunction with other primary mode and operation buttons. Once in desired mode, user can press the Up and Down button to move forward or backward in selections. For example these buttons can be used to set timer clock settings or brightness of the indoor unit display.</p>
	N/A	<p>Reset Button: Pin reset indentation (shown under the “UP” button) allows the user to reset the air conditioner to factory defaults by inserting a pen tip or small screw driver into hole.</p>



 Your Appliance Authority™

 800-570-3355

UNIT OPERATION

Installing Batteries into Remote Control

1. Insert AAA batteries (1.5V) before turning on the remote.
2. Remove the battery cover from the back of the unit, by pushing down the tab at the top of the cover ((1) Figure 2).
3. Lift battery cover off of the unit as shown ((2) Figure 2).
4. Insert the batteries, following the + and - terminal indications inside the battery compartment. Make sure battery is securely in place (Figure 3).
5. Reattach the battery cover.

Figure 2: Remote Control Battery Cover

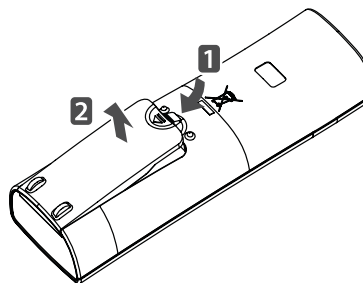

Note:

- If the display screen of the remote control starts to fade, replace the batteries.
- When batteries are removed, the temperature unit will be reset to Celsius as the default.

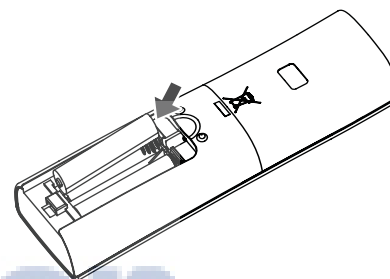

Figure 3: Battery Placement

Installing the Remote Control Holder

Note:

Installation of the remote control holder should be out of direct sunlight, in order to protect the remote control from heat exposure.

1. Choose a safe and easily accessible place to attach the remote control holder.
2. Using a phillips head screwdriver, insert and fasten the 2 screws into the holes at the base (Figure 4).
3. Gently “wiggle” the base to make sure that it is firmly attached to the wall. Tighten the screws further if you feel the wall mount is still loose.
4. Slide the remote control vertically into the holder (Figure 5).

Figure 4: Holder Attachment

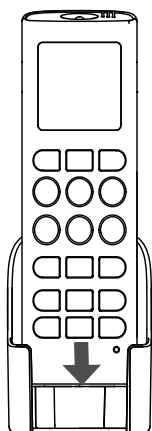
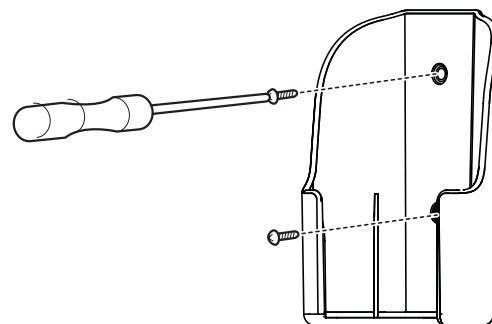

Figure 5: Insertion of Remote into Holder



Initializing Operation of Remote Control

To begin communication between the indoor unit and the remote control, point the remote control towards the signal receiver, located at the bottom right hand corner of the indoor unit (see Figure 6).

Note:

- Make sure to point the remote control directly at the indoor unit, otherwise the remote might accidentally activate and operate other electronic devices due to the signal being picked up.
- For optimum operation, periodically use a soft cloth to wipe the signal transmitter on the remote control and the receiver on the indoor unit.

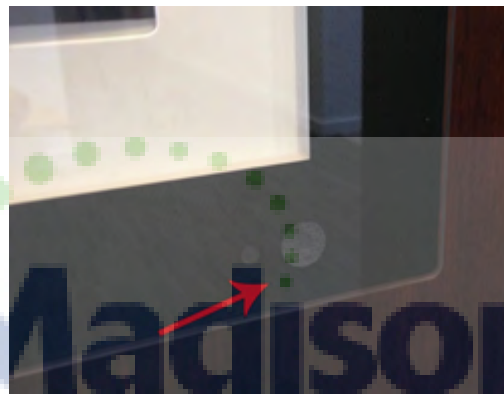
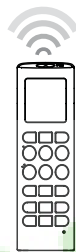

Figure 6: Initializing Remote Control

Refer to Figure 7 for the basic layout of the components of the Single Zone Art Cool Gallery indoor unit, when following operational, maintenance or troubleshooting instructions in this manual.

Indoor Unit Basic Components

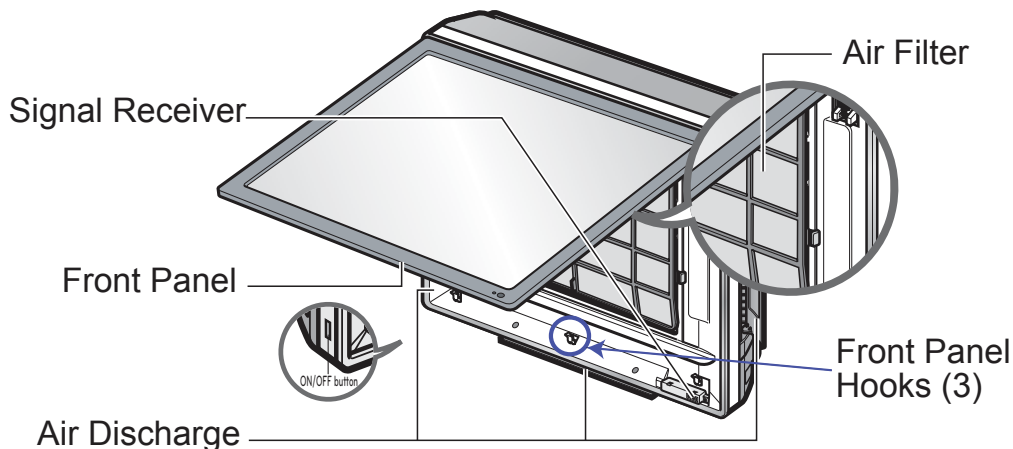





Figure 7: Art Cool Gallery Indoor Unit Basic Components

BASIC FUNCTIONS

Cooling Operation - Adjusting the Air Flow (Swing) Direction

Cooling Operation





1. On the Remote Control, press  to turn on the power to the indoor unit.
2. Press  repeatedly until the cooling symbol (snowflake) ❄️ is displayed on the Remote Control display screen.
3. Press the up and down arrow buttons   to increase or decrease currently displayed temperature.

Note:
The temperature range for cooling is: 65 °F (18 °C) - 86 °F (30 °C).

Air Circulation Operation

This mode only circulates the indoor air without changing the room temperature.

Note:
The cooling lamp lights up in air circulation mode on the indoor unit.

1. On the Remote Control, press  to turn on the power to the indoor unit.
2. Press  to activate the air circulation operation.  will be displayed on the Remote Control display screen.
3. Press  to adjust the fan speed.

Adjusting the Fan Speed











1. Press  repeatedly to adjust the fan speed. See Table 3 below for the various speed adjustments.
2. Select  if you want natural air. The fan speed adjusts automatically.

Table 3: Fan Speed Levels

Display Screen	Speed
	High
	Medium
	Medium - Low
	Natural Wind



Heating Operation

1. On the Remote Control, press  to turn on the power to the indoor unit.
2. Press  repeatedly until the heating symbol (sun) ☀️ is displayed on the Remote Control display screen.
3. Press the up and down arrow buttons   to increase or decrease the currently displayed temperature.

Note:
• The temperature range for heating is: 61 °F (16 °C) - 86 °F (30 °C).
• Cooling-only models do not support this function.



Dehumidifying Operation

This mode removes excess moisture from an environment with high humidity or during local rainy seasons, in order to prevent mold from setting in. It adjusts the room temperature and the fan speed automatically to maintain the optimal level of humidity.

1. On the Remote Control, press  to turn on the power to the indoor unit.
2. Press  repeatedly until the dehumidifying symbol (raindrop) 💧 is displayed on the Remote Control display screen.

Note:
• When indoor unit is in dehumidifying mode, you cannot adjust the room temperature. Temperature is being adjusted automatically.
• While in dehumidifying mode, display screen will not show the temperature value.

Adjusting the Air Flow (Swing) Direction

1. Press  to activate the automatic multi-directional air flow. 
2. Select  on the Remote Control display screen, to choose the horizontal or vertical louver swing direction for air flow.

Note:
• Some Single Zone Inverter Wall Mounted models may not support air flow direction. Check your model to be sure that it is an option.
• When restarting the air conditioner, it will remember the previously set direction of air flow. As a result, the air deflector may not accurately reflect the icon displayed on the Remote Control. If this occurs, press  to adjust the direction of the air flow once more.

Setting the Timer



The Art Cool Gallery unit can be programmed through timer settings to turn on and off at set times during the day and night. This functionality allows you to save energy and utilize the air conditioner more efficiently.

Setting the Current Time

1. Press and hold  for longer than 3 seconds to initiate setting functionality.

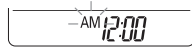
- The AM/PM icon will flicker at the bottom of the display screen.







2. Press one of the up and down buttons,   to scroll and then select the minutes (hours will scroll).
3. Press  when done to exit the setting mode.

Setting Air Conditioner On Time

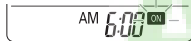
1. Press the **On** button   under the Timer area of the Remote Control.

- An “ON” icon will flicker to the right of the timer display on the display screen.







2. Press one of the up or down buttons   to select the minutes (hours will scroll).
3. Press  when done to exit the setting mode.

Setting Air Conditioner Off Time

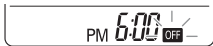
1. Press the **OFF** button   under the Timer area of the Remote Control.





- An “OFF” icon will flicker to the right of the timer display on the display screen.



2. Press one of the up or down buttons   to select the minutes (hours will scroll).
3. Press  when done to exit the setting mode.

Setting Sleep Mode

The Sleep Mode is used to turn off the air conditioner at a certain set time automatically so that you don't have to turn it off manually. It is a “countdown” timer and can be set for up to 7 hours ahead of the current time.

1. Press  to turn on the power.
2. Press **Sleep**  to initiate Sleep Mode settings.
3. Press one of the up or down buttons   to select the number of hours.
4. Press  when done to exit the setting mode.

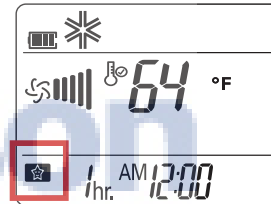

-  appears on the display screen to signify unit has been set to Sleep Mode.



Note:

- In the Cooling and Dehumidifying modes, the temperature increases by 1.8 °F (1 °C) after 30 minutes and by a further 1.8 °F (1 °C) after another 30 minutes for a more comfortable sleep environment. The temperatures increases up to 3.6 °F (2 °C) from the preset temperature.

Cancelling Timer Settings

1. Press  .
- To cancel all timer settings, press  once more.

ADVANCED FUNCTIONS



Jet Cool/Heat Operation - Auto Changeover Operation

Follow the operational directions in this section to work with advanced functionality and features of the Art Cool Gallery Wall Mounted system.

Jet Cool/Heat Operation

Rapid Cooling and Heating of Room Temperature

This functionality allows you to rapidly cool indoor air (during summer months) or warm indoor air (during winter months).

1. Press  to turn on the power.
2. Press the **Jet** button .
 - In Jet Cool Mode, unit operates at a setpoint of 65 °F (18 °C) for a duration of 30 minutes.
 - In Jet Heat Mode, unit operates at a setpoint of 86 °F (30 °C) for a duration of 30 minutes.



Note:

- Jet Cool/Heat Mode cannot be run during Air Circulation, Auto, or Auto Changeover mode.
- This function may not be supported on all Single Zone Inverter models.

Auto Clean Operation

Indoor Air Purification

While in Cooling and Dehumidifying Mode, the air conditioner generates moisture on the interior of the indoor unit. The Auto Clean operation is used to remove this type of moisture.

1. Press  to turn on the power.
2. Press  to start dehumidifying operation.
 -  is displayed on the Remote Control display screen.

Note:

- If the power is turned off, the fan will operate for 30 minutes and will clean the inside of the indoor unit.
- Some buttons (functionality) will not operate while the system is in Auto Cleaning Mode.





°C/°F Screen Display

The Single Zone Art Cool Gallery unit can be set in either °C or °F temperature readout, by pressing and holding the Room Temperature button  for 5 seconds.

Artificial Intelligence

Auto Operation - (Cooling Only Models)

During this functionality, the fan speed and the temperature adjust automatically, based on room temperature.

1. Press  to turn on the power.
2. Press the **Mode** button  repeatedly to select Auto operation  (see icon in Figure 8 below).
3. Press the up and down buttons   to select the desired numerical operation code for cooling/heating strength. See the table in Figure 8 below for a description of each numerical value.

Note:

- During the Artificial Intelligence Mode, you cannot adjust the fan speed.
- During this mode, you can set the air deflector to rotate automatically.
- This function may not be supported on all Single Zone Inverter models.



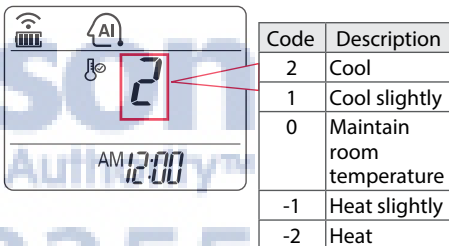



Figure 8: Auto Intelligence Screen with Code Description



Code	Description
2	Cool
1	Cool slightly
0	Maintain room temperature
-1	Heat slightly
-2	Heat

Auto Changeover Operation

This functionality changes the operation mode automatically to maintain a set temperature of ± 3.6 °F (± 2 °C).

1. Press  to turn on the power.
2. Press the **Mode** button  repeatedly to select Auto operation  (see icon display in red box in Figure 9 below).
3. Press the up and down buttons   to select the desired temperature.
 - The temperature range is 64.4 °F (18 °C) through 86 °F (30 °C).
4. Press  repeatedly as needed to adjust the fan speed.

Note:

- This function may not be supported on all Single Zone Inverter models.

Figure 9: Auto Changeover Display

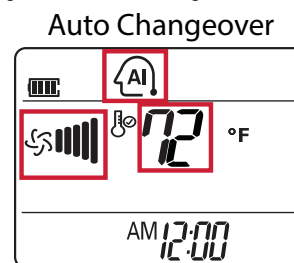





ADVANCED FUNCTIONS

Energy Saving Operation - Automatic Restart

Energy Saving Operation - Cooling

Placing the unit in this mode minimizes power consumption during cooling. It increases the set temperature to the optimal level for a more comfortable environment.

1. Press  to turn on the power.
 2. Press  repeatedly until the cooling symbol (snowflake)  is displayed on the Remote Control display screen.
 3. Press  to place unit into Energy Savings mode.
-  appears on the display screen.

Note:

During Energy Saving mode, you could see a different temperature display between the actual indoor unit and the Remote Control display screen. This does not mean that the unit is malfunctioning in any way.

Adjusting Display Screen Brightness

The indoor unit's screen can be adjusted for brightness.

- Press the **Power** button  repeatedly on the indoor unit to set the brightness to the desired level.

Note:

This function may not be supported on all Single Zone Inverter models.

Auto Restart Functionality

After a power failure, the unit can be programmed to automatically restart (reboot) and remember its previous settings. This function is a factory default setting. However, should you wish to disable the Auto Restart feature, follow the steps below. Refer to Figure 10.

Disable Auto Restart

1. Open the front cover of the indoor unit by lifting up both sides of the cover slightly.
 2. Press  and hold it for 6 seconds.
- The indoor unit will beep twice and the light will blink 6 times.
 - Unit will now be disabled for auto restart.

Re-enable Auto Restart

To re-enable the auto restart function, press  and hold it for 6 seconds.

- The indoor unit will beep twice and the blue lamp will blink 4 times.
- The unit will now be enabled for auto restart.

Note:

- This function may not be supported on all Single Zone Inverter models.
- If you press and hold the  for 3-5 seconds, instead of 6 seconds (in other words, a shorter duration) the unit will be placed in test operation mode. In test operation mode, the unit blows out strong air for cooling for 18 minutes and then returns to the factory default settings.

Figure 10: Art Cool Gallery Indoor Unit Basic Components



MAINTENANCE

Indoor Unit - Cleaning Interval

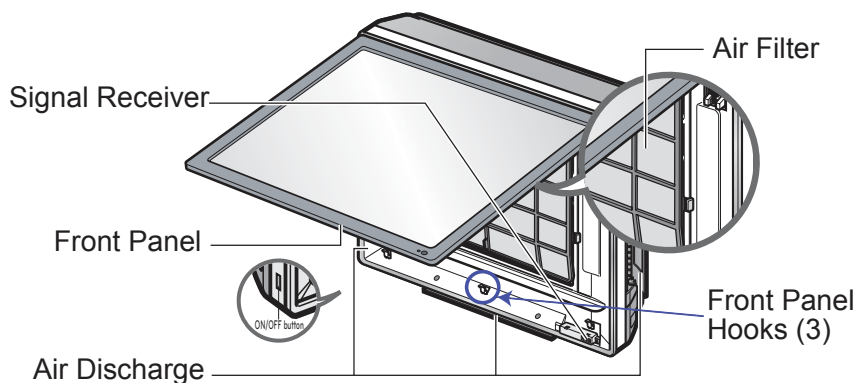
Clean the product regularly to maintain optimal performance and to prevent possible breakdown. Refer to Figure 11 for the basic components of the indoor unit. Refer to Table 4 for detailed instructions on maintenance. Review all safety instructions and warning at the front of this manual; and adhere to all warnings and notes on this page before proceeding with maintenance.

Figure 11: Art Cool Gallery Indoor Unit Basic Components

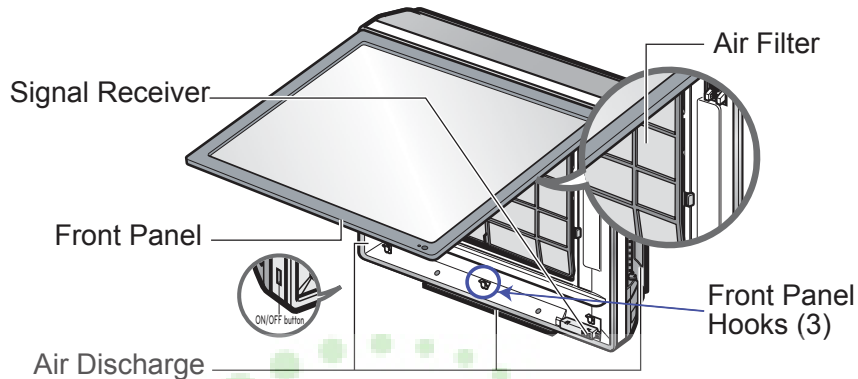

⚠ WARNING

Maintenance Precautions

- Turn off the power and unplug the cord before performing any maintenance to avoid electric shock.
- Never use water that is hotter than 104 °F (40 °C) when cleaning the filters; because it may cause deformation (warping) or discoloration.
- Never use volatile substances when cleaning the filters; because they may damage the surface of the product.

Note:

- The location and shape of the filter may differ in the Single Zone Inverter units, depending on the model.
- Be sure to clean the heat exchanger coils of the outdoor unit regularly. Dirt collected in the coils may decrease the operational efficiency or increase energy costs.

Table 4: Maintenance and Cleaning Interval

Item	Cleaning Interval	Cleaning Instructions
Air filter	Every 2 weeks	See "Air Filter - Cleaning/Maintenance" on page 17.
Indoor unit surface	Regularly	<ul style="list-style-type: none"> • Use a soft, dry cloth. • Do not use bleach or abrasives.
Outdoor unit	Regularly, as needed	<ul style="list-style-type: none"> • Use steam to clean the heat exchanger coils and the panel vents. • If needed, consult with technician on proper care.

Air Filter - Cleaning/Maintenance

Clean the air filter located in the indoor unit, once every 2 weeks or more often as necessary.

1. Pull out the upper section of the front panel, gently from the indoor unit (see Figure 12 below).
 2. Once top is loosened, pull front panel up and then away from the bottom of the unit.
- The bottom of the front panel should snap out of the bottom three front panel hooks (see Figure 11 for placement of hooks).

⚠ WARNING

- Use two hands when lifting the front panel away from the indoor unit.
- Maintain a grip on the front panel at all times while removing the filter.
- Front panel does not have a locking mechanism, so failure to hold the panel open may result in head and bodily injuries.

Figure 12: Lifting of Front Panel from Indoor Unit



3. Using two hands, swing front panel away and then up.
4. Starting at one of the top corners of the filter, detach the filter from the indoor unit (see step #5 in Figure 13).
5. Lift out the entire filter once detached from the unit.
6. Rinse down the filter and let it air dry completely.
7. Place the filter back onto the front of the indoor unit, by hooking

the top of the filter under the two filter tabs as shown in step #6 of Figure 13 below.

8. Place the bottom of the filter into the two filter tabs at the bottom of the indoor unit to complete attachment.
 9. Close the front panel of the indoor unit, by reversing the steps above.
- Take care to place the bottom of the front panel into the three hooks located at the bottom of the indoor unit; in order to anchor the top before pushing in and securing.

Figure 13: Detaching Filter from Indoor Unit



TROUBLESHOOTING

Table 5: Art Cool Gallery Troubleshooting

Issue	Cause	Corrective Action
There is a burning smell and strange sound coming from the unit.	N/A	Immediately turn off the air conditioner. Unplug the power cord and contact the service center.
Water leaks from the indoor unit even when the humidity level is low.		
The power cord is damaged or generating excessive heat.		
A switch, a circuit breaker (safety, ground) or a fuse is not operating properly.		
The air conditioner does not work.	The air conditioner is unplugged.	Check whether the power cord is plugged into the outlet.
	A fuse has blown or the power supply is blocked.	Replace the fuse or check if the circuit breaker has tripped.
	A power failure has occurred.	Turn off the air conditioner when a power failure occurs. When the power is restored, wait 3 minutes, and then turn on the air conditioner.
	The voltage is too high or too low.	Check if the circuit breaker has tripped.
	The air conditioner turned off automatically at a preset time.	Press the power button again.
The air conditioner does not generate cool air.	Air is not circulating properly.	Make sure that there are no curtains, blinds or furniture blocking the front of the air conditioner.
	The air filter is dirty.	Clean the air filter once every 2 weeks. See "Cleaning Air Filter" for more information.
	The room temperature is too high.	In summer, it may take some time to cool indoor air. In this case, select the jet cool operation to cool indoor air quickly.
	Cold air is escaping from the room.	Make sure that no cold air is escaping through ventilation points in the room.
	The desired temperature is higher than the set temperature.	Set the desired temperature to a level lower than the current temperature.
	There is a heating source nearby.	Avoid using a heat generator such as an electric oven or a gas burner while the air conditioner is in operation.
	Air circulation operation is selected.	During the air circulation operation, air blows from the air conditioner without cooling or heating the indoor air. Switch the operation mode to the cooling operation.
It is not possible to adjust the fan speed.	The auto operation, jet operation or dehumidifying operation is selected.	In some operation modes, such as the jet or dehumidifying operation modes, you cannot adjust the fan speed. Check to make sure you are in an operation mode in which you can adjust the fan speed.
It is not possible to adjust the temperature.	The air circulation operation or jet operation is selected.	In some operation modes, such as the air circulation or jet operation mode, you cannot adjust the temperature. Check to make sure you are in an operation mode in which you can adjust the temperature.

Inverter

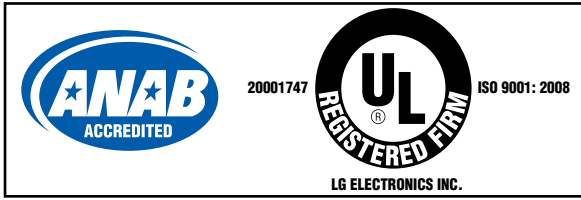

AjMadison
Your Appliance Authority™
800-570-3355



LG Electronics
Commercial Air Conditioning Division
11405 Old Roswell Road
Alpharetta, Georgia 30009
www.lg-vrf.com

LG Electronics Commercial Products Support
1-888-865-3026 USA
Follow the prompts for commercial A/C products.