

Miele

Operating and Installation Instructions



Ceramic Cooktop

KM 5840

KM 5860

KM 5880

To prevent accidents and
appliance damage,
read these instructions

before

installation or use.

en - US, CA

M.-Nr. 07 844 710



IMPORTANT SAFETY INSTRUCTIONS	4
Description of the appliance	9
Control panel	12
Before using for the first time	13
Clean the cooktop	13
Heat the cooktop	13
How the burners operate	14
Use	15
Turning On	15
Power settings	16
Cooking with Auto-heat	17
Variable burner	18
Turning off and residual heat indicators	19
Selecting cookware	20
Timer	21
Setting the timer	22
Turning a burner off automatically	24
Using both timer functions at the same time	25
Safety features	26
Child safety lock / System lock	26
Stop and Go	27
Safety shut-off	28
Overheat protection	29
Cleaning and Care	30
Programming	31
Frequently asked questions	34
Technical Service	37
IMPORTANT INSTALLATION SAFETY INSTRUCTIONS	40
Installation	43
Sealing	44
Tiled surfaces	44
Installation dimensions	45
Installation	48
Electrical connection	51
Help protect our environment	52

IMPORTANT SAFETY INSTRUCTIONS

WARNING- When using your appliance follow basic precautions, including the following:

Read all instructions before installation or use to prevent injury and appliance damage.

This appliance conforms to all uniform safety codes and regulations.

Keep these operating instructions in a safe place and pass them on to any future user.

SAVE THESE INSTRUCTIONS for a future user.

Correct usage

▶ Only use the cooktop for residential cooking, and for the purposes described in this manual. Other uses are not permitted and can be dangerous.

▶ Persons who lack physical, sensory or mental abilities, or experience with the appliance should not use it without supervision or instruction by a responsible person.

Children

▶ Use the safety lock to ensure that unsupervised children cannot turn on the cooktop or change the settings.

▶ Children should not be left unattended in an area where the appliance is in use. Never allow children to sit or stand on any part of the appliance.

Caution: Do not store items of interest to children in cabinets above the appliance. Children climbing on the appliance to reach these items could be injured.

▶ The appliance is hot during use and remains so for some time after being switched off. Keep children away from the appliance.

▶ Keep all pots and pans out of the reach of children. Danger of burning or scalding.

▶ Pot and pan handles should be turned inward and not extend over the countertop to reduce the risk of burns, ignition of flammable materials, and spills.

▶ Ensure that any packing material is disposed of safely and kept out of the reach of children. Danger of suffocation!

IMPORTANT SAFETY INSTRUCTIONS

Technical safety

▶ Installation, repair and maintenance work should be performed by a Miele authorized service technician. Work by unqualified persons could be dangerous and may void the warranty.

▶ Be sure your appliance is properly installed and grounded by a qualified technician.

▶ Before installing the cooktop, check for externally visible damage. **Do not** operate a damaged appliance.

▶ To guarantee the electrical safety of this appliance, continuity must exist between the appliance and an effective grounding system. It is imperative that this basic safety requirement be met. If there is any doubt, have the electrical system of the house checked by a qualified electrician.

▶ Before installation, make sure that the voltage and frequency listed on the rating label correspond with the household electrical supply. To prevent injury and appliance damage, these data must match. Consult a qualified electrician if in doubt.

▶ Do not use an extension cord to connect this appliance to the electrical supply. Extension cords do not ensure the required safety of the appliance.

▶ Install the appliance so that the power cord does not come into contact with any portion of the cooktop which may become hot during use.

▶ Do not use the appliance until it has been properly installed in the countertop.

▶ Before servicing, disconnect the appliance from the main power supply.

▶ Do not operate any appliance with a damaged cord or plug, or if the appliance has been damaged in any manner. Contact Miele's Technical Service Department.

▶ Under no circumstances open the outer casing of the appliance.

▶ While the appliance is under warranty repairs should only be performed by an authorized service technician. Otherwise the warranty is void.

▶ In the event of any damage to the appliance, it must be turned off immediately and disconnected from the main power supply. Contact Miele's Technical Service Department.

▶ Do not use the appliance until it has been repaired. Ensure power is not supplied to the appliance until repair work is completed.

▶ Defective components should be replaced by Miele original spare parts only. Only with these parts can the manufacturer guarantee the safety of the appliance.

▶ Do not cook on a broken cooktop. Any breakages or cracks in the ceramic surface of the appliance are defects and must be treated as such. If the cooktop should break, cleaning solutions and spills may penetrate the broken cooktop and create a risk of electric shock. Do not use the appliance until it has been repaired.

IMPORTANT SAFETY INSTRUCTIONS

Safety

▶ DO NOT TOUCH THE COOKING AREA OR THE VICINITY AROUND THE COOKING AREA - During operation, the cooking area and its surroundings will get hot and can cause burns. When the cooktop is shut off, the surface may remain hot enough to cause harm, even though the glow is not visible through the dark glass. During and after use, do not touch or let clothing or other flammable materials contact the cooking area or the vicinity around the cooking area until they have had sufficient time to cool. As long as the surface temperature is high enough to cause a burn, the Residual Heat Indicator will remain lit. Once sufficient time has passed the indicator will go out and the surface is safe to touch.

▶ Protect your hands with oven mitts or potholders when using the appliance. Use only dry, heat resistant potholders. Moist or damp potholders used on hot surfaces can result in steam burns. Do not let the potholder touch the hot heating elements. Do not use towels or other bulky items near the appliance.

▶ Do not heat unopened containers. Built-up pressure may cause the container to burst and result in injury.

▶ Do not flambé under an exhaust hood. Flames could be drawn up into the hood by the suction and the grease filters may ignite.

▶ Never use the appliance to heat a room. Due to the high temperatures radiated, objects left near the appliance could catch fire.

▶ Do not store items on the appliance when not in use. Items could melt or catch fire from residual heat or if the appliance is turned on inadvertently. Always switch the cooking zone(s) off after use.

▶ Never cover the burner with a cloth or protective oven foil. If inadvertently turned on or if there is residual heat, a fire could result.

▶ Be aware of loose fitting or hanging garments when operating the appliance, they may present a fire hazard.

▶ Never leave an appliance unattended at high settings or when cooking with oil or fat. Overheated oil could ignite. Always heat oil slowly, monitoring it as it heats.

▶ Do not store aerosols, combustibles or any other easily flammable materials underneath or adjacent to the appliance.

▶ Do not use water on grease fires. Smother or use a dry chemical or foam-type extinguisher on any fire or flame.

IMPORTANT SAFETY INSTRUCTIONS

- ▶ Make certain that the power cords of small appliances do not come in contact with the appliance. The insulation of the cable could become damaged. Danger of electric shock!
- ▶ The control panel and/or the areas around the cooktop (the cooktop frames or surrounding (in the case of facet cooktops) may become hot due to the following factors: operating time, high output settings, large cook ware, and number of burners in operation.
- ▶ Be careful not to drop anything on the ceramic surface of the cooktop. Even lightweight objects may cause damage.
- ▶ Use the proper pan size. Select cookware with flat bottoms large enough to cover the heating element. Using undersized cookware will expose a portion of the heating element and may result in ignition of clothing or handles becoming hot. The proper size pot or pan will also improve efficiency.
- ▶ Do not use pots or pans with pronounced edges or ridges on the ceramic cooktop. These could scratch the cooktop permanently. See "Selecting cookware" for more information. Grains of salt and sand can cause scratches. Make sure that the bases of any pots and pans are clean, free of any fat or oils and are dry.
- ▶ To prevent damage to the cooktop do not use pots and pans with thin bases on the cooktop. Never heat an empty pan unless the pan manufacturer states that you can do so.
- ▶ Before using glass, glass/ceramic, ceramic, earthenware or other glazed cookware verify that they can be used on a cooking surface.
- ▶ Do not use plastic or aluminum foil cookware. It melts at high temperatures. Fire hazard.
- ▶ To prevent burns and breathing difficulty, allow the cooktop to cool before cleaning. Some cleaners may produce toxic fumes if applied to a hot surface.
- ▶ Keep the cooktop clean. Grains of salt and sand can cause scratches.
- ▶ When wiping spills on a hot cooktop with a wet sponge or cloth, be careful to avoid steam burns.
- ▶ Do not let flammable materials, i.e. cooking grease, accumulate on the appliance.
- ▶ Do not use a steam cleaner to clean this appliance. Steam could penetrate electrical components and cause a short circuit.
- ▶ Do not allow either solid or liquid sugar, pieces of plastic or foil to fall on the burners when they are hot. If these residues are allowed to cool on the ceramic surface pitting or even cracking may occur.

IMPORTANT SAFETY INSTRUCTIONS

▶ Any spills should be removed as quickly as possible to prevent them from burning on and becoming difficult to remove.

▶ Aluminum cookware or cookware with aluminum base can cause shiny metallic spots. These spots can be removed with ceramic glass or stainless steel cleaner (see "Cleaning and Care").

▶ Never heat up an empty pot, unless the manufacturer explicitly allows this can be done! Failure to comply can result in a damaged cooktop.

▶ NEVER set down hot pots or pans in the area of the control panel. This can damage the underlying electronics.

▶ If the cooktop built in behind a cabinet door, it should only be operated with the door open. Close the door only when the appliance is shut off and the Residual Heat indicators have gone out.

**SAVE THESE INSTRUCTIONS
AND REVIEW THEM
PERIODICALLY**



Description of the appliance

KM 5840

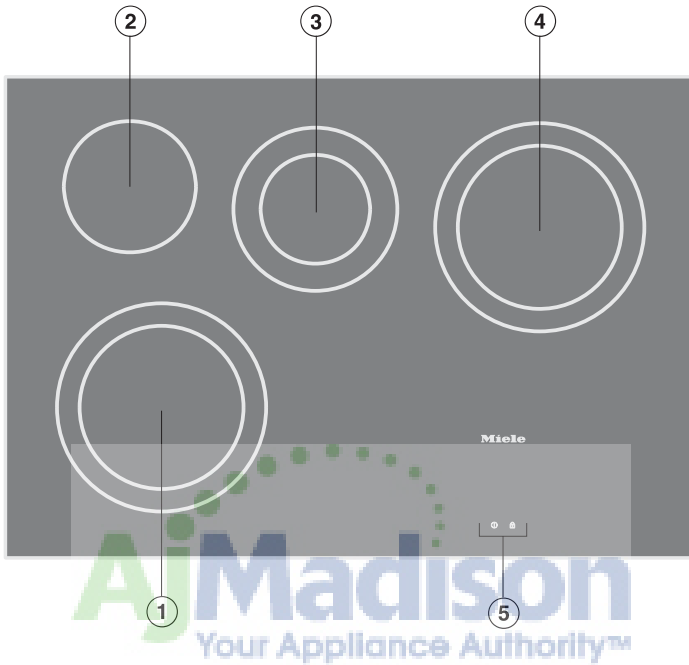

- ①③④ Two-zone variable burners
- ② One-zone burner
- ⑤ Control panel

Burner	Ø Diameter		Output in watts at 208 / 240 V
	inches	cm	
Left front ①	7 1/16" 9 1/16"	18 23	1600 2500
Left rear ②	5 11/16"	14.5	1200
Center rear ③	4 3/4" 7 1/16"	12 18	700 1800
Right rear ④	7 1/16" 9 1/16"	18 23	1600 2500
			Total: 8000

Description of the appliance

KM 5860

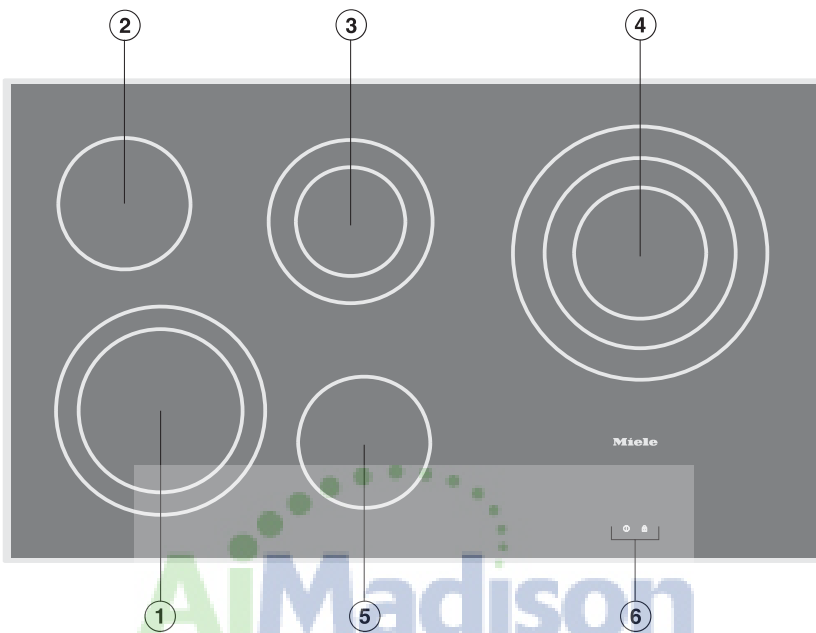

- ①③ Two-zone variable burners
- ②⑤ One-zone burners
- ④ Three-zone variable burner
- ⑥ Control panel

Burner	Ø Diameter		Output in watts at 208 / 240 V
	inches	cm	
Left front ①	7 1/16"	18	1600
	9 1/16"	23	2500
Left rear ②	5 11/16"	14.5	1200
Center rear ③	4 3/4"	12	700
	7 1/16"	18	1800
Right rear ④	5 11/16"	14.5	1100
	8 1/4"	21	2150
	10 5/8"	27	3100
Center front ⑤	5 11/16"	14.5	1200
			Total: 9800

Description of the appliance

KM 5880

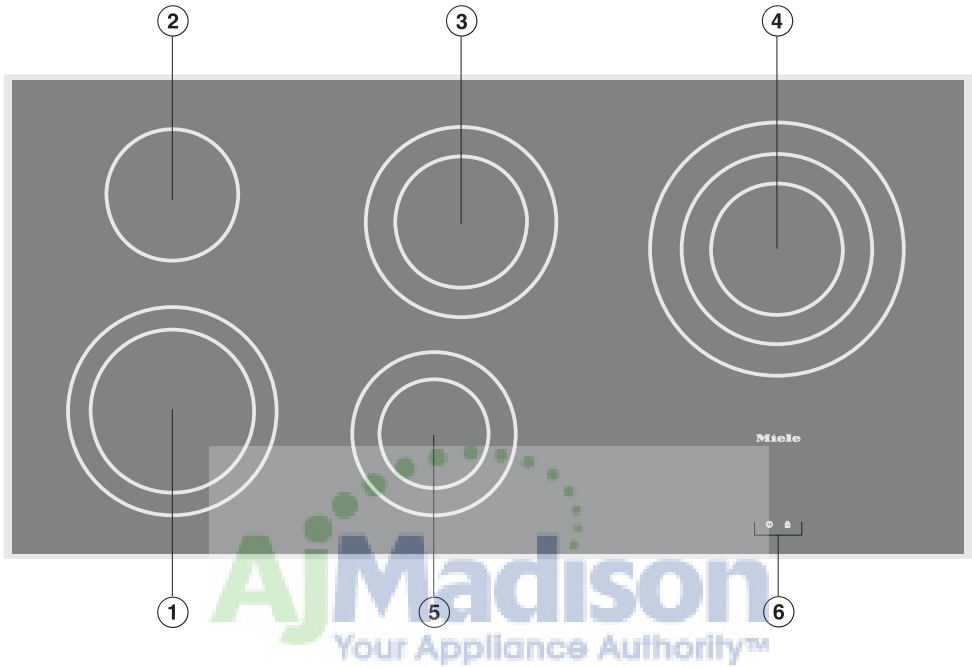

①③⑤ Two-zone variable burners

② One-zone burner

④ Three-zone variable burner

⑥ Control panel

Burner	Ø Diameter		Output in watts at 208/ 240 V
	inches	cm	
Left front ①	7 1/16"	18	1600
	9 1/16"	23	2500
Left rear ②	5 11/16"	14.5	1200
Center rear ③	5 11/16"	14.5	1100
	8 1/4"	21	2400
Right rear ④	5 11/16"	14.5	1100
	8 1/4"	21	2150
	10 5/8"	27	3100
Center front ⑤	4 3/4"	12	700
	7 1/16"	18	1800
			Total: 11000

Description of the appliance

Control panel

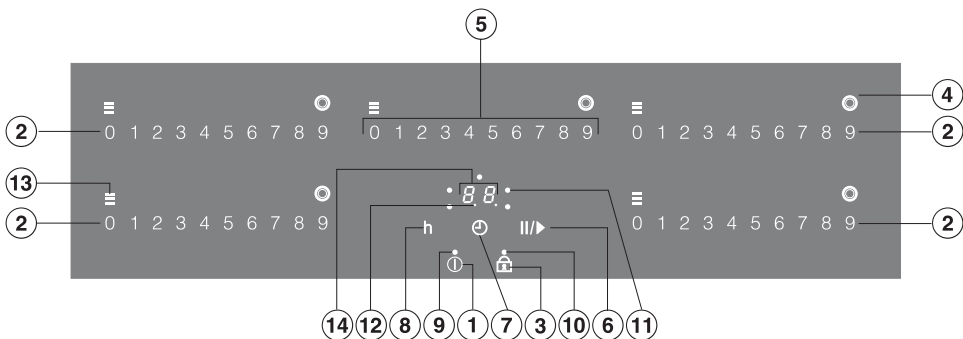

Touch controls

- ① Cooktop On/Off
- ② Settings bar
 - 0 = Burner On/Off
 - 1 - 9 = Setting the power level
- ③ Child safety lock
- ④ Variable burner On/Off
- ⑤ Settings bar for the center rear burner and timer
 - 0 = Burner On/Off
 - 1 - 9 = Setting the power level/Timer
 - 0 - 9 = Setting the time
- ⑥ Stop and Go
- ⑦ - Timer selection
 - Switching between timer functions
 - Selecting the shut-off time (see "Automatic burner shut-off")
- ⑧ Hour function

Indicator lights

- ⑨ Cooktop On/Off
- ⑩ Child safety lock
- ⑪ Burner selection indicator light, e.g. right rear burner
- ⑫ Indicator light for half-hours with a kitchen timer setting of more than 99 minutes
- ⑬ Residual heat indicator

⑭ Timer display

- 00* to *99* = Time in minutes
- 0.h* to *9h* = Time in hours
- P5* = Programming (see respective chapter)

Before using for the first time

Clean the cooktop

- Before using for the first time, clean the appliance with a damp cloth and dry with a soft cloth.

Do not use liquid dish soap to clean the cooktop, this may cause permanent blue discolorations.

Heat the cooktop

Only for facet cooktops:
A small gap between the cooktop and the work surface may be visible in the first days of operation. It will become smaller during use. Despite this small gap, the electrical safety of your appliance is always ensured.

Metal components of the appliance have a protective coating which may give off a slight odor the first time the appliance is heated.

The smell will dissipate after a short time and does not indicate a faulty connection or appliance defect.



AjMadison
Your Appliance Authority™
800-570-3355

How the burners operate

One-zone burners use one heating strip; two-zone burners and grill zones have two heating strips. Depending on the model, the heating strips may be separated by a ring.

Each burner has overheating protection (internal temperature limiter) feature to prevent the ceramic glass from overheating (see "Overheat protection").

When a power level is set, the heat element turns on and the heating strip is visible through the ceramic glass.

The power setting determines how hot the burner will get, and is electronically regulated. This means that the burner will switch on and off as needed to maintain the selected power level.

One-zone burner

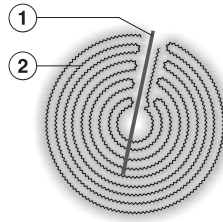

- ① Overheat protection
- ② Heating strip

Two-zone burner

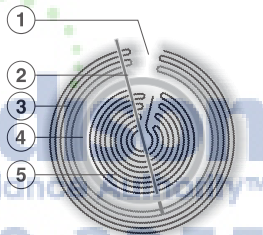

- ① Technical detail, not a defect
- ② Overheat protection
- ③ Outer heating strip
- ④ Insulation
- ⑤ Inner heating strip

AjMaddon
Your Appliance Authority™
800-570-3355

Turning On

The cooktop must be turned on before any of the burners can be used.

Do not leave the appliance unattended during operation!

To turn the cooktop On:

- Touch the ① On/Off touch control .

All the touch controls and the power-ON indicator light will come on. If no further entry is made, the cooktop will turn itself off after a few seconds for safety reasons.

To turn a burner On

- Touch "0" on the settings bar of the desired burner.

To select a power level:

Standard factory setting

- Touch the respective number on the settings bar of the desired burner.

Extended setting

(see "Power settings")

- Touch the space between the numbers.

For example, if you have set power level 7+, the numbers 7 and 8 will be brighter than the other numbers.

To change the power level

- Touch the respective number on the settings bar of the desired burner.

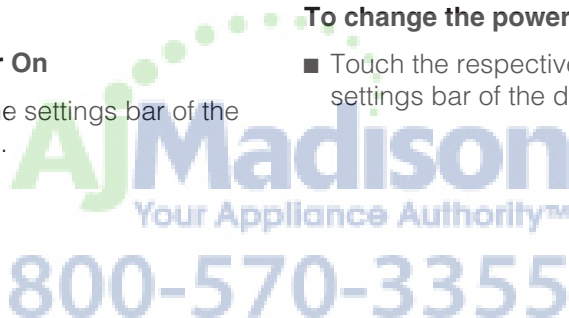

Use

Power settings

The cooktop is factory-programmed with 9 power levels. If you would like finer setting control, you can extend the power levels (see "Programming").

Cooking process	Settings*	
	Standard factory settings (9 power levels)	Extended settings (17 power levels)
Melting butter, chocolate, etc. Dissolving gelatin Preparing yogurt	1 to 2	1 to 2+
Thickening sauces containing only egg yolk and butter Warming small quantities of liquid Keeping food warm which sticks easily Cooking rice	1 to 3	1 to 3+
Warming liquid and half-set foods Thickening creams and sauces, e.g. zabaglione or Hollandaise sauce Making oatmeal Preparing omelets, lightly fried eggs	2 to 4	2 to 4+
Thawing frozen foods Steaming vegetables, fish Cooking pasta	3 to 5	3 to 5+
Bringing to a boil and cooking of large quantities of food	5	5+
Gentle frying of fish, cutlets, sausages, fried eggs, etc.	6 to 7	6 to 7+
Frying pancakes, etc.	7 to 8	7 to 8+
Boiling large quantities of water Bringing to the boil	8 to 9	8+ to 9

* These settings are merely guidelines. A higher setting is required for deep pots, larger quantities or when cooking without a lid. For smaller quantities, select a lower setting.

Cooking with Auto-heat

When Auto-heat has been activated, the burner automatically turns on at the highest setting (heat-up boost) and then switches to the previously selected continued power level. The heat-up time depends on which continued power level has been chosen (see chart).

With higher continued power levels only a relatively short heat-up time is required.

To activate Auto-heat

- Touch the desired continued-cooking number until a signal sounds, and the selected continued power level starts to flash.

During the heat-up time (see chart) the continued power level flashes.

Changing the continued power level deactivates Auto-heat.

With extended power levels (see "Programming"), when an intermediate power level is selected the power levels before and after the intermediate power level will flash.

To deactivate Auto-heat

You can turn off the heat-up boost before the heat-up time ends.

- Touch the continued power level until the display stops flashing; or set a different power level.

Continued power level*	Heat-up time (approx.) min:sec
1	1 : 20
1+	2 : 00
2	2 : 45
2+	3 : 25
3	4 : 05
3+	4 : 45
4	5 : 30
4+	6 : 10
5	6 : 50
5+	7 : 10
6	1 : 20
6+	2 : 00
7	2 : 45
7+	2 : 45
8	2 : 45
8+	2 : 45
9	-

* The continued power levels 1+ etc. are only available with the extended power-level settings (see "Programming").

Use

Variable burner

With some cooktop models (see "Description of the appliance"), you can turn on a second or third burner zone when using larger pots.

If you add another burner zone, the "variable burner" touch control will be brighter than normal. With the three-zone burner, the display does not differentiate between second and third burner zones.

When you turn off a burner, the added burner zones are also turned off.

Two-zone burner

- Touch "0" on the settings bar of the desired burner.
- Touch the respective number on the settings bar to set the desired power level.
- Touch the variable burner control.

Three-zone burner

- Touch "0" on the settings bar of the desired three-zone burner.
- Touch the respective number on the settings bar to set the desired power level.
- Tap the variable burner touch control until the desired number of burner zones has been added.

To turn the additional burner zones off

- Touch the variable burner control until the indicator light goes out.

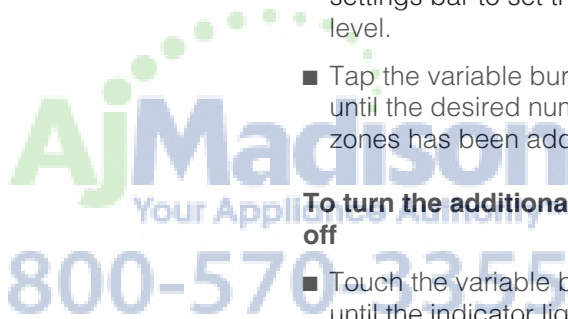

Turning off and residual heat indicators

To turn a burner off

- Touch "0" on the settings bar of the desired burner.

After several seconds the numbers 1 to 9 on the settings bar go out. If the cooking zone is still hot, the residual heat will be displayed.

To turn the cooktop off

- Touch the ① control.

This turns off all the burners. After several seconds the power-ON indicator light and the numbers 1 to 9 on the settings bar go out. The residual-heat displays of the burners that are still hot will light up.

The bars of the residual heat indicator go out one after another as the burners cool down. The last bar only goes out when the burners are safe to touch.

Do not touch any burner or place any heat-sensitive items on a burner as long as the residual heat indicators are lit up. Danger of burning!

After a power failure the residual heat indicator will flash.

Selecting cookware

- Use cookware with thick, flat, smooth bottoms. Slightly concave bottoms will also work adequately. Pans with convex bottoms will not cook well.

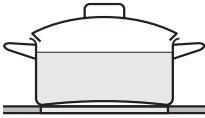

cold

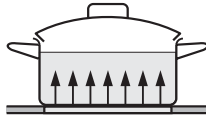

hot

- Cast iron, glass or stoneware should not be used because they have poor heat transfer and may scratch the cooktop surface.
- Also unsuitable is plastic or aluminum foil cookware. These melt at high temperatures.

- **Copper bottom and aluminum pans** may leave a residue on the cooktop in the form of metallic lines. This is normal. These lines can be removed using a non-abrasive ceramic cooktop cleaner or a shielded scraper blade.

Be sure to clean the cooktop after each use. Each time this residue is allowed to melt it becomes harder to remove and may mar the appearance of the cooktop. Let the cooktop cool before cleaning.

- Use only pots and pans with flat bases. Sharp pot and pan bases scratch the ceramic glass surface.
- Lift the cookware when moving it. In this way you will avoid streaking from friction and scratching.

Energy saving tips

- For the most even and energy efficient cooking, the diameter of the pots/pans should match the diameter of the burners as closely as possible.



too small

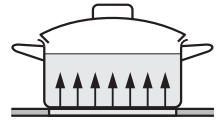

fits

- Whenever possible, keep pots and pans closed while cooking. This helps keep in the most possible heat.



open

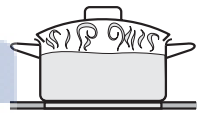

closed

- Use a small pot for small amounts. A small pot on a small burner needs less energy than a larger partly filled pot on a large burner.
- Use little water when cooking and take care to select a lower energy level as soon as cooking is completed.
- For longer cooking periods, you can switch off the cooking zone 5 to 10 minutes before the total cooking time is completed. The residual heat will continue to cook the food.

The cooktop must be turned on to use the timer.

The timer can be used for two different functions:

- To time kitchen activities
- To set a burner to turn off automatically.

You can select a time from 1 minute (**01**) to 9 hours (**9h**).

A time up to 99 minutes is set and displayed in minutes.

Example:

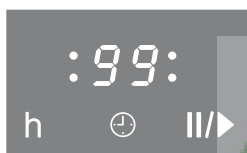

With a time of more than 99 minutes, the timer must be turned to hours. The time is set in half-hour increments. The half hour is indicated by a dot after the number.

Example (2 hours 30 minutes):

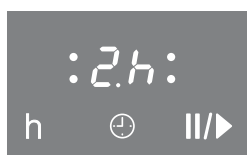

When the set time has elapsed, **00** will appear in the timer display and an audio signal will sound for a few seconds.

Timer

Setting the timer

Minutes

Example: You want to set a time of 15 minutes.

- Turn the cooktop on.
- Touch the ⊖ control.

The ⊖ touch control flashes. **00** appears in the timer display, and the right **0** will flash.



- Touch the first number of the time you wish to set (in this case 1) on the settings bar.

The timer display changes, **1** flashes on the right.

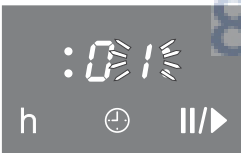

- Touch the second number (in this case 5) on the settings bar.

The timer display changes, the **1** "jumps" to the left and **5** appears on the right.

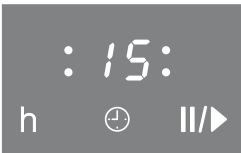

After several seconds, the ⊖ touch control light turns steady, and the timer begins to count down.

Hours

To set full hours, touch the respective number on the settings bar.

To set the half hours, touch the space between 2 numbers on the settings bar. Example: 2 hours and 30 minutes

- Turn the cooktop on.
- Touch the ⊖ control.

The ⊖ touch control flashes. **00** appears in the timer display, and the right **0** will flash.

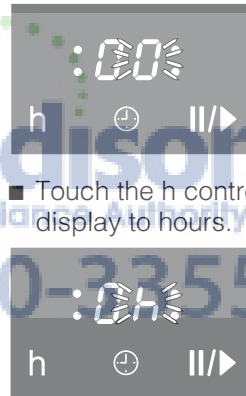

- Touch the h control to switch the display to hours.

- Touch the settings bar between the numbers 2 and 3.

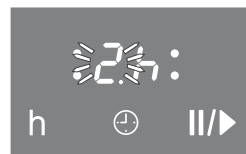

After several seconds, the ⊖ touch control and the timer display stop flashing and turn steady. The timer starts counting down.

To change the set time

- Touch the ⊖ control.
- Set the desired time as described in "Setting the timer".

To clear the set time

- Touch the ⊖ control.
- Touch "0" on the settings bar.



Timer

Turning a burner off automatically

You are able to set a time in which a burner turns off automatically. If desired, all of the burners can be programmed at the same time.

If the programmed time is longer than the maximum time allowed, the burner will turn off automatically after the maximum time allowed (see "Safety cut-out feature").

- Select a power level for the desired burner.
- Tap the ⊖ touch control until the indicator light for the burner starts flashing.

If several burners are on, the indicator lights will flash in a clockwise direction, starting with the left front.

- Set the desired time.

The time counts down in minutes. The time remaining is shown in the timer display and can be changed at any time.

If you want to set another burner to turn off automatically, follow the same steps as previously described.

If more than one shut-off time is programmed, the shortest time remaining will be displayed, and the indicator light for that particular burner will flash. The other indicator lights will be steady. If you want to check on the remaining time for another burner, touch the ⊖ control until the indicator light for the respective burner flashes.



Using both timer functions at the same time

The kitchen timer and automatic shut-off functions can be used at the same time.

If you have programmed one or more shut-off times and would also like to set the kitchen timer:

Tap the ⊕ touch control until the indicator lights for the programmed burners come on steady and **00** appears in the timer display.

If you have set the timer and would also like to program one or more shut-off times:

Tap the ⊕ touch control until the indicator light for the desired burner flashes.

The shortest remaining time will appear in the display.

If you would like the other remaining times to be displayed, tap the ⊕ control until:

- the indicator light for the desired burner flashes (automatic shut-off).
- the timer display flashes (kitchen timer).

Starting with the shortest remaining time, which is shown in the display, all burners that are in use and the kitchen timer are selected in a clockwise direction.



Safety features

Child safety lock / System lock

Your appliance is equipped with a safety lock to prevent the cooktop and the burners from accidentally being turned on or any settings changed.

The **Child safety lock** can be activated when the cooktop is turned on. When the safety lock is activated, the cooktop has only limited functions:

- The burner power levels and the timer settings cannot be changed.
- The burners, the cooktop and the timer can be turned off, but once off they cannot be turned on again.

The **system lock** can be activated when the cooktop is turned off. When the system lock is activated, the cooktop cannot be turned on and the timer cannot be used.

The appliance is programmed so that the system lock must be activated manually.

The system lock can be programmed to be activated automatically 5 minutes after the cooktop has been turned off, providing the safety lock is not manually activated first (see "Programming").

If a locked control is touched when the safety lock or the system lock is activated, the indicator light comes on and the timer display shows **LL** for a few seconds.

If there is an interruption to the power supply, the Child safety lock and the system lock will be deactivated.

To activate the locks

- Touch the  control until the respective indicator light comes on.

The indicator light will go out after a short time.

You can alter the setting from one-finger to three-finger operation (see "Programming"), for instance to make it harder for children to operate the appliance.

To deactivate the locks

- Touch the  control until the respective indicator light goes out.



Stop and Go

Your appliance has a Stop and Go feature which, when activated, reduces the power of all the activated burners to level 1. The burner power-levels and the timer setting cannot be changed, the cooktop can only be turned off.

When Stop and Go is deactivated, the cooking zones resume at the power level which was last set.

If Stop and Go is not deactivated, the cooktop turns off after 1 hour.

When Stop and Go is **activated**:

- the timer will continue without interruption
- the countdown of a time programmed for automatic shut-off will be interrupted,

When **deactivated** the countdown time will continue to run.

To activate Stop and Go

- Touch the II/▶ control.

The power of the activated burners will be reduced to level 1.

To deactivate Stop and Go

- Touch the II/▶ control.

The burners will now run at the power level that was previously set.

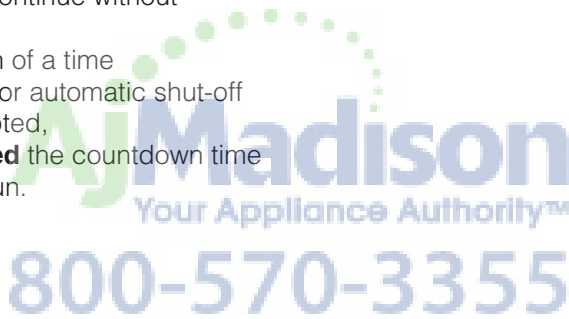

Safety features

Safety shut-off

Safety shut-off for cooking times that are too long

If a burner is heated for an unusually long period of time (see chart) at the same power level, the cooktop will turn itself off automatically and the residual heat indicator will appear.

To use the burner again, turn it back on in the usual way.

Power level*	Maximum operating time in hours
1 / 1+	10
2 / 2+	5
3 / 3+	5
4 / 4+	4
5 / 5+	3
6 / 6+	2
7 / 7+	2
8 / 8+	2
9	1

* Power levels with a "+" are only available with the extended power-level settings (see "Programming").

Safety shut-off if the touch controls are covered

Your cooktop will turn off automatically if one or several of the touch controls remain covered for longer than 10 seconds, for example by fingers, food that boils over or by an object placed on them.

An *F* will flash in the timer display.

- Clean the control panel or remove the object covering the control.

F will go out. The cooktop can now be used again.

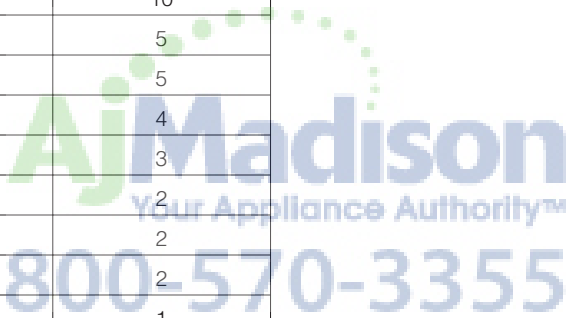

Overheat protection

Each burner is equipped with a temperature limiter. This feature automatically turns off the heating element before the glass ceramic surface becomes too hot.

When the overheat protection is triggered, the heating element turns on and off even at the highest power level.

Once the glass ceramic surface has cooled to a safe temperature the heating element will automatically turn back on.

The overheat protection is activated by:

- turning a burner on without putting a pan on it.
- heating an empty pan.
- a pan with an uneven bottom not sitting evenly on the burner.
- the pan not conducting heat properly.



Cleaning and Care

Do not use a steam cleaner to clean this appliance. Steam could penetrate electrical components and cause a short circuit. Pressurized steam could cause permanent damage to the surface.

Do not use any sharp pointed objects which could damage the seal between the ceramic surface, the surrounding frame and the countertop.

Never use abrasive cleaners, caustic (oven) cleaners, dishwasher detergent, scouring pads, steel wool or hard brushes. They will damage the surface.

The ceramic surface can be cleaned using a cleaner for ceramic surfaces. Follow the manufacturer's instructions.

Make sure that no cleaner residue remains on the ceramic surface by carefully wiping the cooktop with a damp cloth. They may damage the cooktop or produce toxic fumes when heated.

Be sure that pot and pan bases are clean and dry.

After cleaning dry the ceramic surface with a soft cloth to prevent a build up of limescale deposits.

Clean any spills immediately before they become difficult to remove.

Clean the appliance regularly, preferably after each use. Allow the appliance to cool before cleaning.

Ceramic surfaces

- Wipe off any soiling using a damp cloth. Stubborn soiling is best removed with a shielded scraper blade.
- Apply a ceramic cleaner (available from Miele) using a soft cloth or paper towel.
- To remove any limescale deposits or metallic residue apply a ceramic cleaner using a soft cloth or use a shielded scraper blade if necessary.
- After cleaning wipe the ceramic surface with a damp cloth and dry.

A cleaner with a special additive to prevent water marks and smears on the ceramic surface may be used.

Any melted solids like **sugar, plastic or aluminum foil** should be removed as quickly as possible, while the burner is still warm. If they are allowed to harden the cooktop may become pitted.

- Turn the burner off.
- Using a shielded scraper blade, scrape the melted item **immediately** off the burner while it is still hot.
Use caution: Danger of burns!
- Allow the cooktop to cool and clean as previously described.

The programming of your cooktop can be modified (see chart).

After starting the programming function **P** (Program) and an **5** (Status) will appear in the timer display. With cooktops that have 3 burners, an additional display appears at the back left.

The program is displayed in the front left and back left settings bars.

Example:

Program 3 = front left **3**, back left **0**

Program 14 = front left **4**, back left **1**

The status is displayed in the front right settings bar.

Once you have left the programming mode, the cooktop will be reset automatically. This is completed when an indicator above the On/Off **⓪** touch control lights up briefly.

Do not turn the cooktop on again until the reset process is completed.

To set the program

- To set the **first number**, touch the respective number on the **back left** settings bar.
- To set the **second number**, touch the respective number on the **front left** settings bar.

To set the status

- Touch the respective number on the **front right** settings bar.

To save the settings

- Touch the **⓪** control until the displays go out.



If you do not wish to save the settings

- Touch the **🔒** control until the displays go out.

To start programming

- With the cooktop turned off, touch and hold the **⓪** control and **🔒** **at the same time**, until the Child safety lock indicator flashes.

Programming

Program*	Status**	Setting
P 0 Demo mode and factory default settings	S 0	Demo mode On
	S 1	Demo mode Off
	S 9	Factory default settings restored
P 2 Extended power levels	S 0	9 power levels (1, 2, 3 ... to 9)
	S 1	17 power levels (1, 1+, 2, 2+, 3 ... to 9)
P 4 Keypad tone when a control is touched	S 0	Off
	S 1	Quiet
	S 2	Medium
	S 3	Loud
P 5 Audible timer tone	S 0	Off
	S 1	Quiet, 10 seconds
	S 2	Medium, 10 seconds
	S 3	Loud, 10 seconds
P 6 Child safety lock	S 0	One-finger lock using 
	S 1	Three-finger lock by touching  and level "0" of the two right-hand burners
P 7 System lock	S 0	Only manual activation of the system lock
	S 1	Manual and automatic activation of the System lock

* Programs / settings not shown here have no allocation.

** The factory default settings are shown in bold.

Programming

Program*	Status**	Setting
P 8 Auto-heat	S 0	Off
	S 1	On
P 10 Miele@home (only on communication-enabled appliances fitted with a communication module)	S 0	Feature not available
	S 1	Signed off
	S 2	Signed on
P 11 Second burner zone of the left front burner	S 0	Does not turn on with the first zone
	S 1	Always turns on with the first zone
P 12 Second burner zone of the right front burner	S 0	Does not turn on with the first zone
	S 1	Always turns on with the first zone
P 13 Second burner zone of the right back burner	S 0	Does not turn on with the first zone
	S 1	Always turns on with the first zone
P 14 Second burner zone of the center back burner	S 0	Does not turn on with the first zone
	S 1	Always turns on with the first zone
P 15 Audible tone when the sensor areas are accidentally covered	S 0	Off
	S 1	On
P 16 Touch control reaction speed	S 0	Slow
	S 1	Normal
	S 2	Fast

* Programs not listed here have no allocation.

** The factory default settings are shown in bold.

Frequently asked questions

 Repairs should only be carried out by an authorized technician in accordance with local and national safety regulations. Unauthorized repairs could cause injury or appliance damage.

Cooktop or burners cannot be turned on

Possible fault	Solution
The circuit breaker has tripped.	Reset the circuit breaker (see the data plate for minimum breaker ratings).
There may be a technical problem.	<ul style="list-style-type: none"> – Disconnect the appliance from the main power supply for approx. 1 minute. Reset the circuit breaker or replace the fuse and turn the appliance back on. If the appliance still cannot be turned on, contact a qualified electrician or Miele.

"L \bar{L} " appears in the timer display for several seconds after turning on the cooktop.

The system lock has been activated.	Deactivate the system lock (see "Child safety lock / System lock").
-------------------------------------	---

"dE" appears in the timer display for several seconds after switching on the cooktop. Burners do not heat up.

The device is in demo mode.	Deactivate demo mode (see "Programming").
-----------------------------	---

The cooktop turns off while it is in use.

One of the burners has been on for too long.	Not a fault. You can start the burners again (see "Safety shut-off").
--	---

The heating for one of the burners turns on and off.

Power levels 1 to 8: Not a fault.	This turning on and off is normal. It is caused by the electronic heat regulation (see "How the burners operate").
Power level 9: Fault. The overheating protection has triggered.	The overheat protection automatically turns a burner off if the ceramic surface is in danger of overheating. Once the ceramic surface has cooled down, the burner automatically turns back on (see "Overheat protection".)

Frequently asked questions

The cooktop turns off while in use, and a flashing <i>F</i> appears in the timer display.	
Possible fault	Solution
One or several of the touch controls are covered, for example by fingers, food boiling over or by an object.	Clean the control panel or remove the object (see "Safety shut-off".)
Auto-heat is turned on, but the food does not start cooking.	
Large amounts of food are being heated.	Start cooking at the highest power level, then reduce the power level manually.
The cookware conducts heat poorly.	See "Selecting cookware".
One or several residual heat indicators are flashing.	
There was a power failure during operation, and the cooktop shut itself off.	Not a fault. Restart the cooktop.
The residual heat indicators have lit up during programming.	Not a fault. The display flashes until the maximum residual heat has expired or the burner is selected and activated.

Frequently asked questions

The sensor switches are hypersensitive or not sensitive enough.

Possible fault	Solution
The sensitivity of the touch controls has changed.	First, ensure that the cooktop is not in direct sunlight or strong artificial light and that the area around the cooktop is not too dark. Make sure that neither the cooktop or the touch controls are covered. Remove any cookware and clean the cooktop, removing any food residues. Disconnect the cooktop from the main power supply for approx. 1 minute. If the problem persists, contact Miele.

FE flashes alternately with numbers in the timer display.

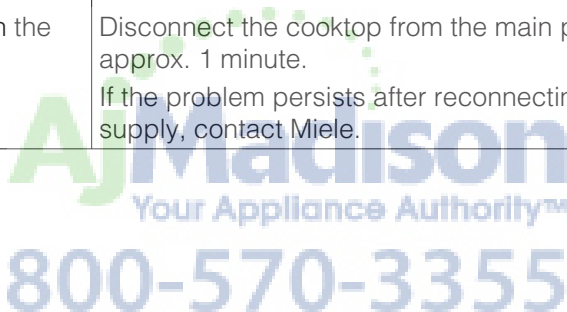

In the event of a fault which you cannot easily fix yourself, please contact the Miele Technical Service Department at the address on the back of this booklet. When contacting Technical Service please quote the serial number and model of the cooktop. This information is visible on the silver data plate supplied with the cooktop. Adhere the data plate sticker to the box below:

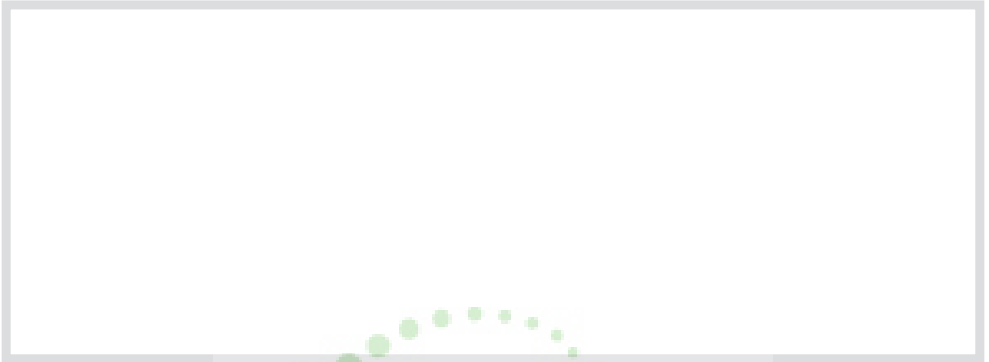

MieleCare

MieleCare, our Extended Service Contract program; gives you the assurance of knowing that your appliance investment is covered by 5 years of worry free ownership. **MieleCare** is the only Extended Service Contract in the industry that guarantees repairs by a Miele Authorized Service Provider using genuine Miele parts. Only genuine Miele parts installed by factory trained professionals can guarantee the safety, reliability and longevity of your Miele appliance.

Please note that unless expressly approved in writing by the Miele Service department, Extended Service Contracts offered by other providers for Miele products will not be recognized by Miele. Our goal is to prevent unauthorized (and untrained) service personnel from working on your Miele products, possibly doing further damage to them, you and/or your home.

To learn more about **MieleCare** Extended Service Contracts, please contact your appliance dealer or visit us online at:

<http://mieleusa.com/mielecare>



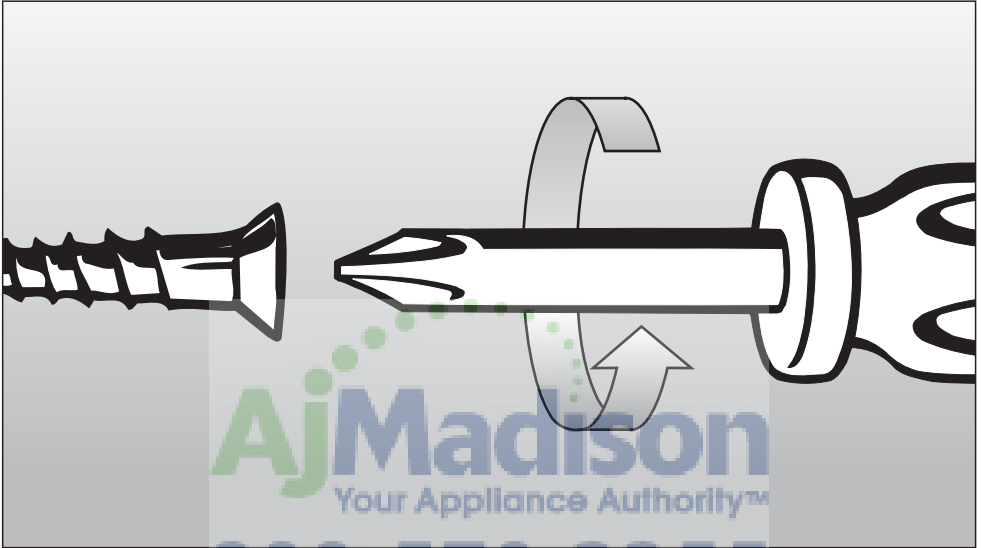

Installation Instructions

IMPORTANT: SAVE FOR THE LOCAL ELECTRICAL INSPECTOR'S USE

Information is subject to change. Please refer to our website to obtain the most current product specification, technical & warranty information.

To prevent accidents
and appliance damage
read these instructions

before

installation or use.

IMPORTANT INSTALLATION SAFETY INSTRUCTIONS

Note to the installer:

Please leave this instruction book with the consumer for the local electrical inspector's use.

The minimum distances given in these Installation Instructions must be observed in order to ensure safe operation. Failure to do so increases the risk of fire.

The cabinetry and venting hood should be installed first to prevent damage to the cooktop.

▶ The countertop must be bonded with heat resistant (212°F/100°C) adhesive to prevent distortion or dissolving. Any back splashes should also be heat-resistant.

▶ The cooktop must not be installed over a dishwasher, washer, dryer, refrigerator or freezer. Heat radiated by the cooktop may damage them.

▶ To eliminate the risk of burns or fire by reaching over heated surfaces cabinet storage space above the appliance should be avoided. If cabinet storage is necessary, the risk can be reduced by installing a venting hood to project horizontally a minimum of 5" (127 mm) beyond the bottom of the cabinets.

▶ This appliance has not been designed for maritime (e.g. ships) use or for use in mobile installations such as recreational vehicles or aircraft. However, under certain conditions it may be possible for installation in these applications. Please contact the Miele Technical Service Department with specific requirements.

▶ You must ensure the power cable for the appliance will not come into contact with the floor panel after installation, nor be subject to any mechanical strain.

▶ The cooktop must not be permanently sealed into the countertop when installed. The sealing strip under the edge of the cooktop provides a sufficient seal for the countertop. See "Sealing".

▶ The safety distances specified in these instructions must be followed carefully.

Keep this instruction book in a safe place for reference and pass it on to any future user.

IMPORTANT INSTALLATION SAFETY INSTRUCTIONS

Safety distance from divider

Installation of a divider under the cooktop is not required.

If a divider is fitted under the cooktop, the distance between the upper edge of the work surface and the upper edge of the divider must be at least 4 ½ " (110 mm).

A gap of at least 1 3/8" (35 mm) must be provided between the rear edge of the divider and the rear wall of the cabinet so that the power cord can be passed through.

Safety distances above the appliance

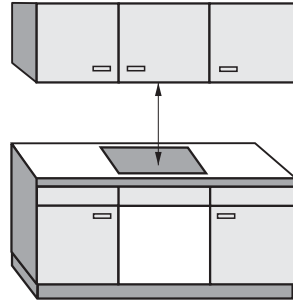

The minimum safety distance given by the hood manufacturer must be maintained between the cooktop and the hood above it. See the installation instructions of the hood for these safety measurements.

If the hood manufacturer's instructions are not available or if flammable objects are installed over the cooktop (e.g. cabinets, utensil rail, etc.), a minimum safety distance of 30" (760 mm) must be maintained.

If there is more than one appliance beneath a hood (e.g. wok burner and electric cooktop), and they have different minimum safety distances, always observe the greater distance.

AjMacdonald
Your Appliance Authority
800-570-3333

IMPORTANT INSTALLATION SAFETY INSTRUCTIONS

Safety distances to the sides of the appliance

The appliance should only be installed as shown in the illustrations, while maintaining the required safety distances shown. Do not install the appliance between two tall cabinets, this is a fire hazard.

- ① 1 5/8" (40 mm) minimum distance from the countertop cut-out to the rear edge of countertop or wall.
- ② Minimum distance from the right of the countertop cut-out to the closest adjacent piece of furniture (for instance, a high cabinet) or a room wall.
KM 5840 = 2" (50 mm)
KM 5860 / KM 5880 = 4" (100 mm)
- ③ 2" (50 mm) minimum distance from the left of the countertop cut-out to the closest adjacent piece of furniture (for instance, a high cabinet) or a room wall.

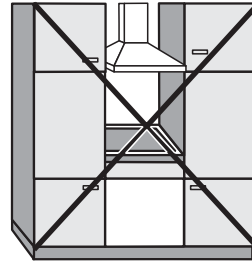

not allowed

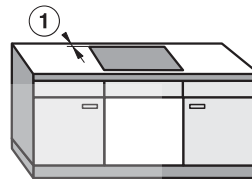

recommended

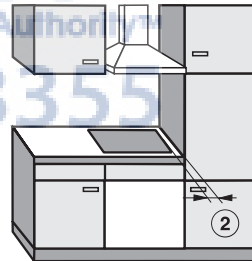

not recommended

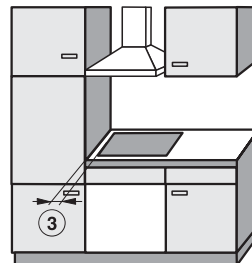

not recommended

Safety distance from the wall covering

If a wall covering is installed, a minimum safety distance must be maintained between the countertop cut-out and the covering, since high temperatures can damage these materials.

If the covering is made of a combustible material (such as wood), the distance between the countertop cut-out and the wall covering must be a minimum of 2" (50 mm).

For coverings made of non-combustible materials (such as metal, marble, granite or ceramic tiles) the minimum safety distance ⑤ between the countertop cut-out and the wall covering must be 2" (50 mm) minus the thickness of the covering.

For example: thickness of wall covering 9/16" (15 mm)

2" (50 mm) - 9/16" (15 mm) = minimum safety distance 1 3/8" (35 mm).

Cooktops flush with the countertop

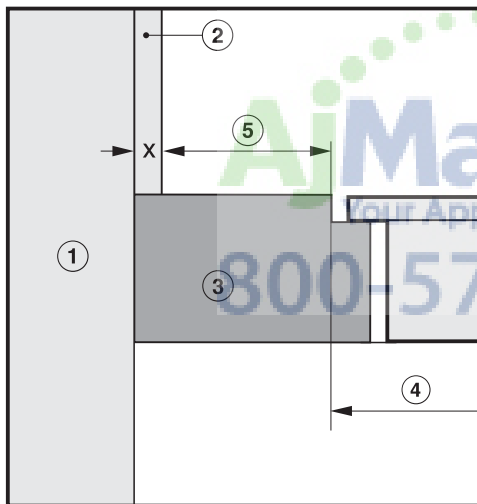

Frame/Facet cooktops

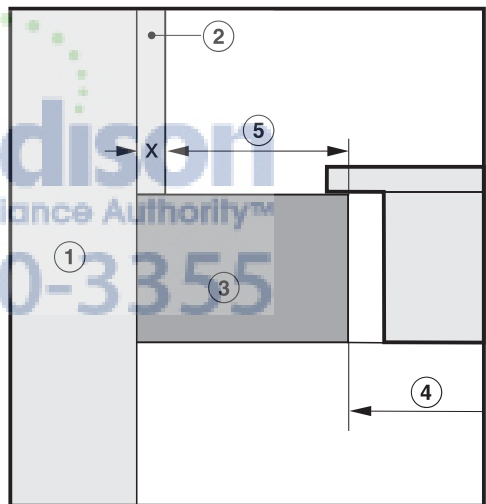

- ① Wall frame
- ② Wall covering
x = thickness of the wall covering
- ③ Countertop
- ④ Countertop cut-out
- ⑤ Minimum safety distance
with flammable materials 2" (50 mm)
with non-flammable materials 2" (50 mm) minus **x**

Installation

Frame/Facet Cooktops

Sealing

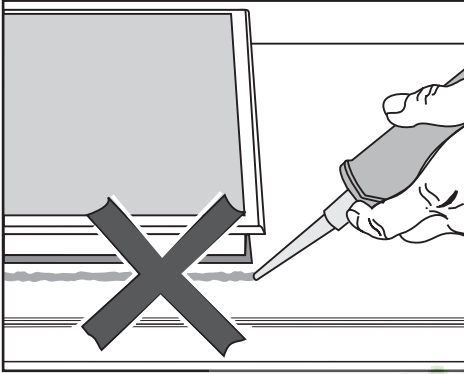

The appliance must not be permanently sealed into the countertop when installed. The sealing strip under the edge of the appliance provides a sufficient seal for the countertop.

If the appliance is sealed into position, the countertop or appliance could be damaged if it needs to be removed for maintenance or service.

Tiled surfaces

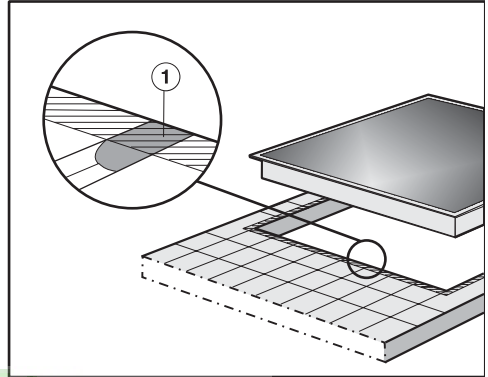

The grouting ① and shaded area under the appliance frame must be flat and even so that the frame will lie evenly and the sealing strip under the edge of the upper part of the appliance can provide an adequate seal against the countertop.

Installation dimensions

KM 5860

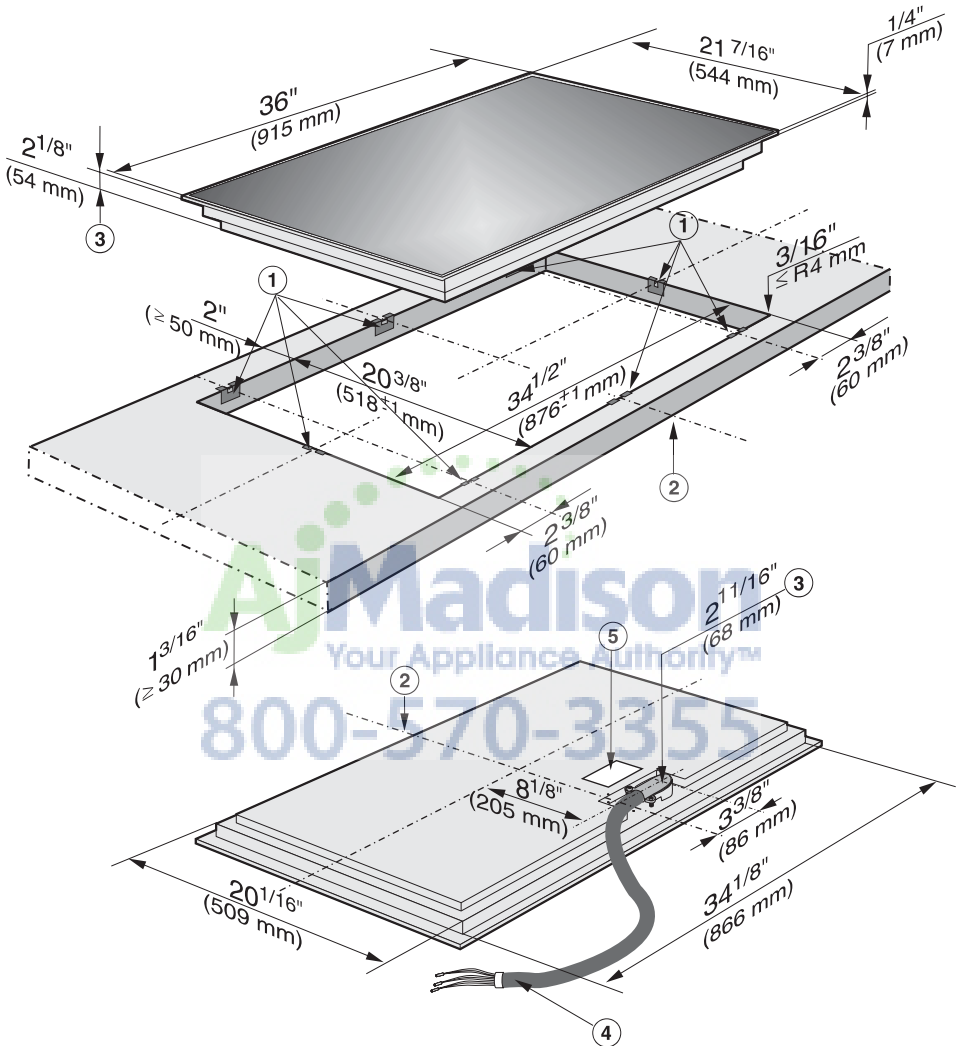

- ① Spring clips
- ② Front
- ③ Installation height
- ④ Connecting cable, Length = 56 11/16" (1440 mm)
- ⑤ Rating label

Installation

The exact positions of the spring clamps and the support bars (for beveled cooktops only) are shown in the "Installation dimensions" of each unit.

Facet cooktops:

A special sealing strip ensures the slip-proof seating of the cooktop in the cutout. The gap between the frame and the countertop will narrow after a little time has passed.

- Create the countertop cutout as shown in the "Installation dimensions". Observe the safety distances (see "Installation Safety Instructions").

Wood or solid surface countertop

- Seal the cut surfaces with a suitable sealant to avoid swelling caused by moisture. The materials used must be heat resistant.

Ensure that these materials do not get on the top surface of the countertop panels.

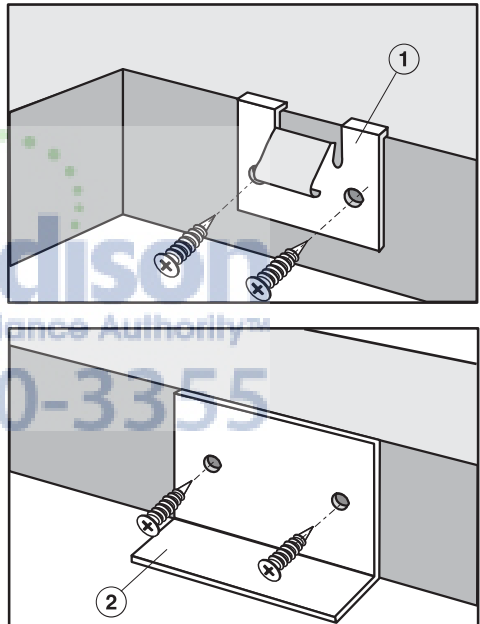

- Position the spring clips and the securing strips (supplied with the appliance; only for facet cooktops) on the top edge of the cut-out
- Attach the spring clips ① and the securing strips ② with the 3.5 x 25 mm wood screws (supplied).

Granite countertop

Strong double-sided adhesive tape and silicon are required for installation (not included).

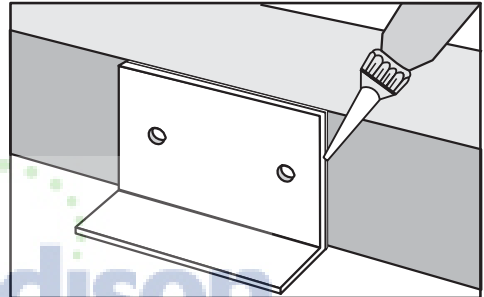
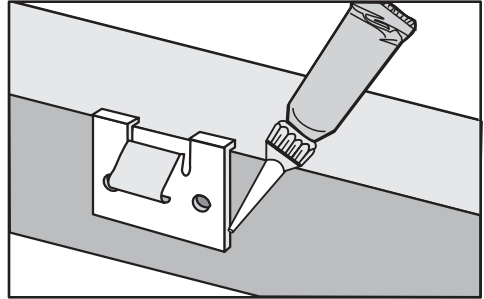
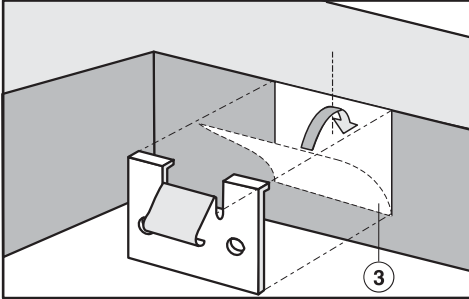

- Coat the lateral edges and the lower edge of the spring clips and securing strips with silicon.

- Using adhesive tape ③ attach the spring clips and the securing strips (for facet cooktops only)

The spring clips and the securing strips must be on or flush with the top edge of the cooktop.

Installation

Insert the cooktop

- Feed the power cord down through the cut-out.
- Place the cooktop lightly on the spring clips.
- With a hand on each side of the appliance press down evenly on the edges until it clicks into position. When doing so make sure that the appliance seal sits tightly on the countertop to ensure it is sealed correctly. This is important to ensure an effective seal. **Do not** permanently seal into the countertop.

If during installation the seal around the frame does not sit flush with the countertop in the corners, the corner radius, maximum $\frac{3}{16}$ " (4 mm), can be carefully filed down to fit.

- Connect the appliance to the main power supply (see "Electrical connection").
- Turn the appliance on and check the function.

The appliance may be lifted out using a special tool.
The appliance can also be pushed up and out from underneath.

 **CAUTION:** Before installation or servicing, disconnect the power supply by either removing the fuse, shutting off the main power or manually "tripping" the circuit breaker.

Installation work and repairs should only be performed by a qualified technician in accordance with all applicable codes and standards. Repairs and service by unqualified persons could be dangerous and the manufacturer will not be held responsible.

Before connecting the appliance to the power supply, make sure that the voltage and frequency listed on the rating label correspond with the household electrical supply. This data must correspond to prevent appliance damage. Consult an electrician if in doubt.

Only operate the appliance after it has been installed into the countertop.

Installer:
Please leave these instructions with the consumer.

Power supply

- Be sure your electrical supply matches the data plate.

The rating label is located on the underside of the appliance.

The appliance is equipped with a flexible metal conduit encasing 3 wires ready for connection to a grounded power supply.

It must be connected to a dedicated line through the use of an approved junction box.

A disconnection incorporated in the fixed wiring must be provided. There must be an all-pole contact gap of at least 3 mm in the isolator switch (including switch, fuses and relays).

Black wire: connect to L1 (hot)

Red wire: connect to L2 (hot)

Green wire: connect to GND (ground)

KM 5840
208/240 V, 60 Hz, 40 A fuse rating

KM 5860
208/240 V, 60 Hz, 50 A fuse rating

KM 5880
208 V, 60 Hz, 60 A fuse rating
240 V, 60 Hz, 50 A fuse rating

Be sure the power outlet is accessible after installation.

For further information, see the wiring diagram provided with the appliance.

 **WARNING:**
THIS APPLIANCE MUST BE GROUNDED!

Help protect our environment

Disposal of packing materials

The cardboard box and packing materials are biodegradable and recyclable. Please recycle.

Ensure that any plastic wrappings, bags, etc. are disposed of safely and kept out of the reach of children. Danger of suffocation!

Disposal of an old appliance

Old appliances contain materials that can be recycled. Please contact your local recycling authority about the possibility of recycling these materials.

Before discarding an old appliance disconnect it from the electrical supply and cut off the power cord to prevent it from becoming a hazard.









Please have the model and serial number of your appliance available before contacting Technical Service.

Miele

U.S.A. Miele, Inc.

National Headquarters

9 Independence Way
Princeton, NJ 08540
Phone: 800-843-7231
609-419-9898
Fax: 609-419-4298
www.mieleusa.com

Technical Service & Support Nationwide

Phone: 800-999-1360
Fax: 888-586-8056

TechnicalService@mieleusa.com

Canada Miele Limited

Headquarters and Showroom

161 Four Valley Drive
Vaughan, ON L4K 4V8
Phone: 800-643-5381
Fax: 905-532-2290
www.miele.ca
professional@miele.ca
(commercial enquiries)

MieleCare National Service

Phone: 800-565-6435
905-532-2272
Fax: 905-532-2292
customercare@miele.ca
(general and technical enquiries)



www.miele-shop.com