

KM 5621 240V

Electric cooktop

with four cooking zones and direct rotary dial controls for maximum convenience.

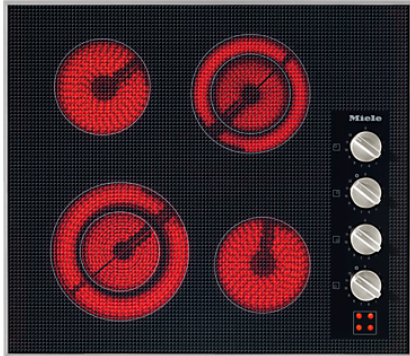

- Easy and direct controls - operation via knob controls
- Attractive design - 24 3/4 (626)Inch wide with stainless steel frame
- Versatile - 4 cooking zones
- Safe - residual heat indicator for every cooking zone

EAN: 4002514865898 / material number: 07821660

Type of heating	
Fuel type	Electrical
Construction type	
Independent of oven	•
Design	
Elegant glass ceramic surface	•
Ceramic surface color	Black
Print design	Basalt grey decor
All-round stainless steel frame	•
Ring features	
No. of rings	4
Ring	
Position	front left
Type	Variable cooking zone
Size in inches (mm)	Ø 120 / Ø 210
Max. rating in W	900/2400
Position	rear left
Type	Single-circuit ring
Size in inches (mm)	Ø 145
Max. rating in W	1200
Position	rear right
Type	Variable cooking zone
Size in inches (mm)	120/180 mm
Max. rating in W	700/1800
Position	front right
Type	Single-circuit ring
Size in inches (mm)	Ø 145
Max. rating in W	1200
Control panel	
Operation via knobs	•
Display color	Red
Extended ring area	•
Efficiency and sustainability	
Residual heat utilization	•
Cleaning convenience	
Easy to clean ceramic surface	•
Safety	
Overheating protection	•
Residual heat indicator	•
Technical data	
Dimensions in in. (width)	24 3/4 (626)
Dimensions (height) in in.(mm)	3 1/4 (81)
Dimensions (depth) in in.(mm)	21 1/2 (544)
Built-in height with mains connection box in in.(mm)	3 (75)
Cutout dimensions in in. (width) with proud-mounted installation	22 3/8 (567)
Cutout dimensions in in. (depth) with proud-mounted installation	20 1/2 (518)
Weight in lbs. (kg)	28 (13)
Total connected load in kW	6.6
Power cord length in m	4 (1.4)

More information at www.MieleUSA.com

For further information please see next page...

KM 5621 240V

Electric cooktop
with four cooking zones and direct rotary dial controls for maximum convenience.

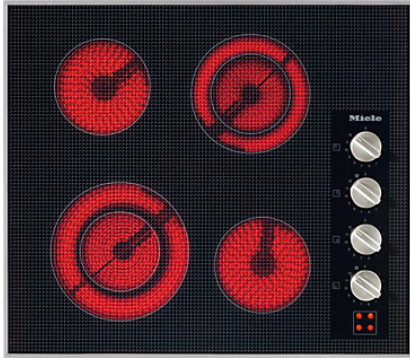

Standard accessories	
Razor-blade scraper	•
Connection wire	•

KM 5621 240V

Electric cooktop

with four cooking zones and direct rotary dial controls for maximum convenience.

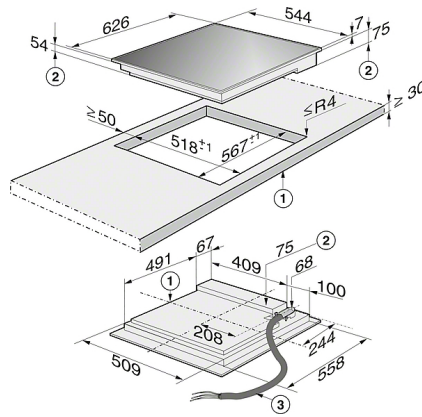
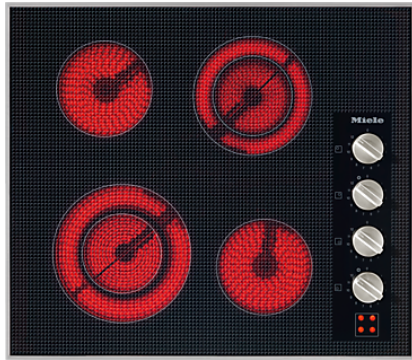

KM 5621 (Installation drawing)

1. Front
2. Building-in depth
3. Flexible metal hose, L = 1200 mm

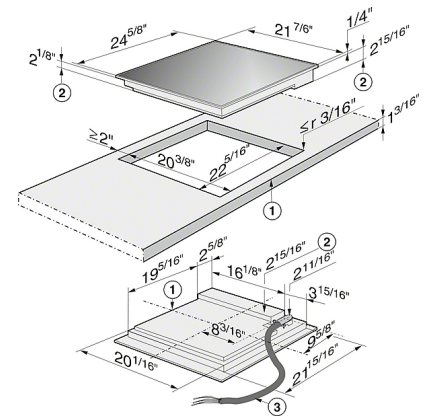

KM 5621 (Installation drawing)

1. Front
2. Building-in depth
3. Flexible metal hose, L = 47 1/4"