

## Kubus KBX110-8 Stainless Steel

Kubus models feature straight lines and tight radius corners for a fresh new aesthetic. Available in double undermount configurations or as individual sinks.

Product Picture



Technical Drawing

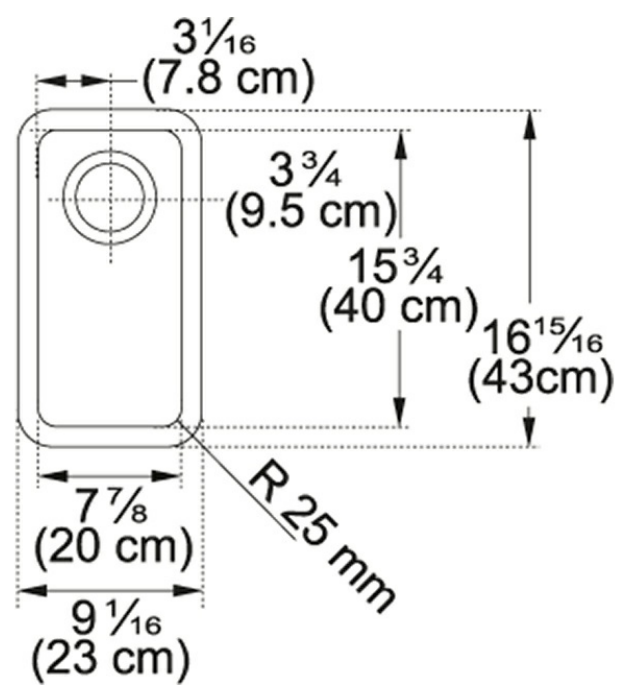

Product Dimensions

Length overall	9 1/16"
Width overall	16 15/16"
Length of large bowl	7 7/8"
Width of large bowl	15 3/4"
Depth of large bowl	5 7/8"
Minimum Cabinet Size	12"

General Information

Type of Material	20 Gauge Stainless Steel
Number of Bowls	1
Installation Clips	Yes
Cut-Out Template	Yes
Where to buy	Showroom

Article Numbers

FUN#	112.0035.087
US Part Number	KBX110-8

