



# Self-Cleaning Gas Ranges

**Safety Instructions** ..... 2-5

**Operating Instructions**

Clock and Timer ..... 14, 15  
Oven ..... 8-32  
    Baking and Roasting ..... 11  
    Broiling, Broiling Guide ..... 12, 13  
    Oven Control ..... 8, 9  
    Power Outage ..... 7, 10, 15  
    Preheating ..... 11  
    Sabbath Feature ..... 18, 19  
    Self-Cleaning ..... 23, 24  
    Shelves ..... 10  
    Special Features ..... 17  
    Steam Clean ..... 33  
    Thermostat Adjustment ..... 20  
    Timed Baking  
    and Roasting ..... 16  
Surface Cooking ..... 6-8  
Warming Drawer ..... 21, 22

**Care and Cleaning**

Aluminum Foil ..... 12  
Burner Assembly ..... 25, 26  
Burner Grates ..... 28  
Control Panel and Knobs ..... 28, 29  
Cooktop ..... 28  
Door Removal ..... 30  
Drawer ..... 32  
Oven Bottom ..... 30  
Oven Light Replacement ..... 32  
Oven Vents ..... 28  
Racks ..... 31  
Self-Cleaning ..... 23, 24  
Stainless Steel Surfaces ..... 31

**Installation**

**Instructions** ..... 34-44  
Air Adjustment ..... 43  
Anti-Tip Device ..... 44  
Assemble Surface Burners ..... 41, 42  
Checking Burner  
Ignition ..... 42  
Connecting the Range  
    to Gas ..... 39, 40  
Dimensions and  
    Clearances ..... 36, 37  
Electrical Connections ..... 41  
Leveling the Range ..... 43  
LP ..... 38

**Troubleshooting**  
**Tips** ..... 45-48

**Accessories** ..... 49

**Consumer Support**

Consumer Support ... Back Cover  
Warranty for Customers  
in Canada ..... 51  
Warranty for Customers  
in the U.S.A. .... 50

**Owner's Manual  
& Installation  
Instructions**

- JGBS04
- JGBS07
- JGBS18
- JGBS23
- JGSS05
- JGB3000
- JGB3001
- JGB250
- JGB281
- JGB282
- JGB285
- JGB300
- JGB400
- JGBP27
- JGBP28
- JGBP33
- RGB790

For a Spanish version of this manual, visit our Website at [GEAppliances.com](http://GEAppliances.com).

Para consultar una version en español de este manual de instrucciones, visite nuestro sitio de internet [GEAppliances.com](http://GEAppliances.com).

In Canada contact us at: [www.GEAppliances.ca](http://www.GEAppliances.ca)

Write the model and serial numbers here:

Model # \_\_\_\_\_

Serial # \_\_\_\_\_

You can find them on a label on the front of the range behind the warming drawer or lower oven drawer.

# IMPORTANT SAFETY INFORMATION. READ ALL INSTRUCTIONS BEFORE USING.

## **⚠ WARNING**

If the information in this manual is not followed exactly, a fire or explosion may result, causing property damage, personal injury or death.

- Do not store or use gasoline or other flammable vapors and liquids in the vicinity of this or any other appliance.
- **WHAT TO DO IF YOU SMELL GAS**
  - Do not try to light any appliance.
  - Do not touch any electrical switch; do not use any phone in your building.
  - Immediately call your gas supplier from a neighbor's phone. Follow the gas supplier's instructions.
  - If you cannot reach your gas supplier, call the fire department.
- Installation and service must be performed by a qualified installer, service agency or the gas supplier.

## **⚠ WARNING**



- All ranges can tip.
- BURNS or other SERIOUS INJURIES can result.
- **INSTALL** and **CHECK** the anti-tip bracket following the instructions supplied with the bracket.

To reduce the risk of tipping the range, the range must be secured by a properly installed anti-tip bracket. See installation instructions shipped with the bracket for complete details before attempting to install.



To check if the bracket is installed and engaged properly, look underneath the range to see that the rear leveling leg is engaged in the bracket. On some models, the storage drawer or kick panel can be removed for easy inspection. If visual inspection is not possible, slide the range forward, confirm the

anti-tip bracket is securely attached to the floor or wall, and slide the range back so the rear leveling leg is under the anti-tip bracket.

If the range is pulled from the wall for any reason, always repeat this procedure to verify the range is properly secured by the anti-tip bracket.

Never completely remove the leveling legs or the range will not be secured to the anti-tip device properly.

If you did not receive an anti-tip bracket with your purchase, call 1.800.626.8774 to receive one at no cost (in Canada, call 1.800.561.3344). For installation instructions of the bracket, visit [GEAppliances.com](http://GEAppliances.com) (in Canada, [GEAppliances.ca](http://GEAppliances.ca)).

## **⚠ WARNING**

### IMPORTANT SAFETY NOTICE

The California Safe Drinking Water and Toxic Enforcement Act requires the Governor of California to publish a list of substances known to the state to cause cancer, birth defects or other reproductive harm, and requires businesses to warn customers of potential exposure to such substances.

The fiberglass insulation in self-clean ovens gives off a very small amount of carbon monoxide during the cleaning cycle. Exposure can be minimized by venting with an open window or using a ventilation fan or hood.

## SAVE THESE INSTRUCTIONS

## **⚠ WARNING** GENERAL SAFETY INSTRUCTIONS

### **⚠ WARNING**

**NEVER use this appliance as a space heater to heat or warm the room. Doing so may result in carbon monoxide poisoning and overheating of the oven.**

- Use this appliance for its intended purpose as described in this owner's manual.
- Have your range installed and properly grounded by a qualified installer in accordance with the provided installation instructions. Any adjustment and service should be performed only by a qualified gas range installers or service technicians. Do not attempt to repair or replace any part of your range unless it is specifically recommended in this manual.
- Your range is shipped from the factory set for use with natural gas. It can be converted for use with LP gas. If required, these adjustments must be made by a qualified technician in accordance with the installation instructions and local codes. The agency performing this work assumes responsibility for the conversion.
- Have the installer show you the location of the range gas shut-off valve and how to turn it off if necessary.
- Plug your range into a 120-volt grounded outlet only. Do not remove the round grounding prong from the plug. If in doubt about the grounding of the home electrical system, it is your responsibility and obligation to have an ungrounded outlet replaced with a properly grounded, three prong outlet in accordance with the National Electrical Code. Do not use on extension cord with this appliance.
- Before performing any service, unplug the range or disconnect the power supply at the household distribution panel by removing the fuse or switching off the circuit breaker.
- Be sure all packing materials are removed from the range before operating to prevent ignition of these materials.
- Avoid scratching or impacting glass doors, cooktops or control panels. Doing so may lead to glass breakage. Do not cook on a product with broken glass. Shock, fire or cuts may occur.
- Do not leave children alone or unattended in an area where an appliance is in use. They should never be allowed to climb, sit or stand on any part of the appliance.
- Do not store items of interest to children above a range or on the backguard of a range—children climbing on the range to reach items could be seriously injured.
- Do not allow anyone to climb, stand or hang on the oven door, drawer or cooktop. They could damage the range or tip it over causing severe injury or death.
- Never block the vents (air openings) of the range. They provide the air inlets and outlets that are necessary for the range to operate properly with correct combustion. Air openings are located at the rear of the cooktop, at the top and bottom of the oven door, and at the bottom of the range under the warming drawer, lower oven drawer or kick panel.
- Use only dry pot holders—moist or damp pot holders on hot surfaces may result in burns from steam. Do not let pot holders touch surface burners, burner grate, or oven heating element. Do not use a towel or other bulky cloth in place of pot holders.
- Be careful not to touch hot surfaces of the range. Potentially hot surfaces include burners, grates, cooktop, backguard, oven and door interior and crevices around the oven door.
- Do not heat unopened food containers. Pressure could build up and the container could burst, causing an injury.
- Cook meat and poultry thoroughly—meat to at least an internal temperature of 160°F and poultry to at least an internal temperature of 180°F. Cooking to these temperatures usually protects against foodborne illness.

SAVE THESE INSTRUCTIONS

# IMPORTANT SAFETY INFORMATION.

## READ ALL INSTRUCTIONS BEFORE USING.

---

### **⚠ WARNING** KEEP FLAMMABLE MATERIALS AWAY FROM THE RANGE

---

- Do not store or use flammable materials in an oven or near the cooktop, including paper, plastic, pot holders, linens, wall coverings, curtains, drapes and gasoline or other flammable vapors and liquids.
- Never wear loose-fitting or hanging garments while using the appliance. Avoid storing commonly used items in cabinets above the range and be careful when reaching over the range. Clothing in close proximity to burners or hot surfaces may ignite causing severe burns.
- Do not let cooking grease or other flammable materials accumulate in or near the range. Grease in the oven or on the cooktop may ignite.
- Clean ventilating hoods frequently. Grease should not be allowed to accumulate on the hood or filter.

### **⚠ WARNING** IN THE EVENT OF A FIRE, TAKE THE FOLLOWING STEPS TO PREVENT INJURY AND FIRE SPREADING:

---

- Do not use water on grease fires. Never pick up a flaming pan. Turn the controls off. Smother a flaming pan on a surface burner by covering the pan completely with a well-fitting lid, cookie sheet or flat tray. If necessary, use a multi-purpose dry chemical or foam-type fire extinguisher.
- If there is a fire in the oven during baking, turn the oven off and keep the door closed until the fire goes out. If necessary, use a multi-purpose dry chemical or foam type fire extinguisher.
- If there is a fire in the oven during self-clean, turn the oven off and wait for the fire to go out. Do not force the door open. Introduction of fresh air at self-clean temperatures may lead to a burst of flame from the oven. Failure to follow this instruction may result in severe burns.

### **⚠ WARNING** COOKTOP SAFETY INSTRUCTIONS

---

- Never leave the surface burners unattended at medium or high heat settings. Foods, especially oily foods, may ignite resulting in fire that could spread to surrounding cabinets.
- Never leave oil unattended while frying. If allowed to heat beyond its smoking point, oil may ignite resulting in fire that may spread to surrounding cabinets. Use a deep fat thermometer whenever possible to monitor oil temperature.
- To avoid oil spillover and fire, use a minimum amount of oil when shallow pan-frying and avoid cooking frozen foods with excessive amounts of ice.
- Use proper pan size and avoid pans that are unstable or easily tipped. Select cookware that is matched to the size of the burner. Burner flames should be adjusted so that they do not extend beyond the bottom of the pan. Excessive flame may be hazardous.
- Always use the LITE position when igniting the top burners and make sure the burners have ignited.
- When using glass/ceramic cookware, make sure it is suitable for cooktop service; others may break because of sudden change in temperature.
- To minimize the possibility of burns, ignition of flammable materials and spillage, the handle of a container should be turned toward the center of the range without extending over nearby burners.
- When preparing flaming foods under a hood, turn the fan on.
- Do not use a wok with a round metal support ring. The ring may trap heat and block air to the burner resulting in a carbon monoxide hazard.
- Do not attempt to lift the cooktop. Doing so may damage the gas tubing to the surface burners resulting in a gas leak and risk of fire.
- Do not use aluminum foil to cover the grates or line any part of the cooktop. Doing so may result in carbon monoxide poisoning, overheating of the cooktop surfaces, or a potential fire hazard.

## **⚠ WARNING** OVEN SAFETY INSTRUCTIONS

**⚠ WARNING** NEVER cover any slots, holes, or passages in the oven bottom or cover an entire rack with materials such as aluminum foil. Doing so blocks air flow through the oven and may cause carbon monoxide poisoning. Aluminum foil linings may also trap heat, causing a fire hazard.

- Stand away from the range when opening the oven door. Hot air or steam which escapes can cause burns to hands, face and/or eyes.
- Keep the oven free from grease buildup. Grease in the oven may ignite.
- Place oven racks in desired location while oven is cool. If rack must be moved while oven is hot, be careful to avoid touching hot surfaces.
- Pull the oven rack to the stop-lock position when loading and unloading food from the oven. This helps prevent burns from touching hot surfaces of the door and oven walls.
- Do not leave items such as paper, cooking utensils or food in the oven when not in use. Items stored in an oven can ignite.
- Do not leave items on the cooktop near the oven vent which is in the center of the backguard. Items may overheat resulting in a risk of fire or burns.
- When using cooking or roasting bags in the oven, follow the manufacturer's directions.
- Never broil with door open. Open-door broiling is not permitted due to overheating of control knobs.

## **⚠ WARNING** SELF-CLEANING OVEN SAFETY INSTRUCTIONS

*The self-cleaning feature operates the oven at temperatures high enough to burn away food soils in the oven. Follow these instructions for safe operation.*

- Before operating the self-clean cycle, remove pans, shiny metal oven racks and other utensils from the oven. Only porcelain-coated oven racks may be left in the oven. Do not use self-clean to clean other parts, such as grates.
- Before operating the self-clean cycle, wipe grease and food soils from the oven. Excessive amount of grease may ignite leading to smoke damage to your home.
- If the self-cleaning mode malfunctions, turn the oven off and disconnect the power supply. Have it serviced by a qualified technician.
- Do not clean the door gasket. The door gasket is essential for a good seal. Care should be taken not to rub, damage or move the gasket.
- Do not use oven cleaners. No commercial oven cleaner or oven liner protective coating of any kind should be used in or around any part of the oven.

## **⚠ WARNING** WARMING DRAWER/LOWER OVEN DRAWER SAFETY INSTRUCTIONS *(Some models)*

- The purpose of the warming drawer is to hold hot cooked foods at serving temperature. Bacteria will grow in food while it is below 140°F. Do not put cold food in warming drawer. Do not heat food for more than 2 hours. Failure to follow these instructions may result in foodborne illness.
- Do not leave paper products, plastics, canned food or combustible materials in the drawer. They may ignite.
- Do not touch the heating element or the interior surface of the drawer. These surfaces may be hot enough to cause burns.
- Use care when opening the drawer. Open the drawer a crack and let hot air or steam escape before removing or replacing food. Hot air or steam that escapes can cause burns to hands, face and/or eyes.
- Do not use aluminum foil to line the warming drawer. Foil is an excellent heat insulator and will trap heat beneath it. This will upset the performance of the drawer and potentially cause a fire hazard.

SAVE THESE INSTRUCTIONS

# Using the gas surface burners.

Throughout this manual, features and appearance may vary from your model.

## Before Lighting a Gas Burner

- Make sure all burners are in place.
- Make sure all grates on the range are properly placed before using any burner.

## After Lighting a Gas Burner

- Do not operate the burner for an extended period of time without cookware on the grate. The finish on the grate may chip without cookware to absorb the heat.
- Be sure the burners and grates are cool before you place your hand, a pot holder, cleaning cloths or other materials on them.

## How to Light a Gas Surface Burner

**⚠ WARNING** Burner flames that are not covered by cookware may present a risk of fire or clothing ignition. The griddle burner should only be used with the griddle in place. Failure to do so may result in serious injury.

Make sure all the surface burners are placed in their respective positions.

Push the control knob in and turn it to the **LITE** position.

You will hear a little **clicking** noise—the sound of the electric spark igniting the burner.

Turn the knob to adjust the flame size. If the knob stays at **LITE**, it will continue to click.

When one burner is turned to **LITE**, all the burners spark. Do not attempt to disassemble or clean around any burner while another burner is on. An electric shock may result, which could cause you to knock over hot cookware.

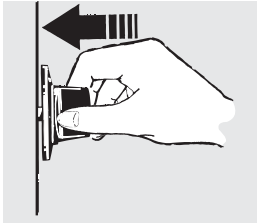

Push the control knob in and turn it to the **LITE** position.

## Sealed Gas Burners

Your gas range cooktop has sealed gas burners. They offer convenience, cleanability and flexibility to be used in a wide range of cooking applications.

The smallest burner in the right rear position is the simmer burner. On some models, the right front position triple flame burner will be the simmer burner. This burner can be turned down to **SIM** for a very low simmer setting. It provides precise cooking performance for delicate foods such as sauces or foods that require low heat for a long cooking time.

The medium (left rear) and the large (left front) burners are the primary burners for most cooking. These general-purpose burners can be turned down from **HI** to **LO** to suit a wide range of cooking needs.

The extra large burner (right front, triple flame burner, or left front burner on some models) are the maximum output burners. Like the other four burners, it can be turned down from **HI** to **SIM** for a wide range of cooking applications.

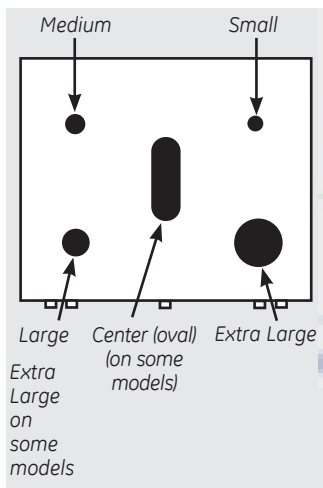

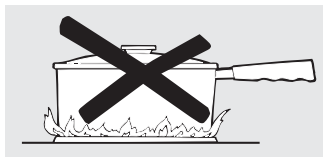

### How to Select Flame Size

**⚠ WARNING** Flames that are not covered by cookware may present a risk of burns or clothing ignition. Never let flames extend beyond the sides of the cookware.

Watch the flame, not the knob, as you adjust heat. When fast heating is desired, the flame size on a gas burner should match the cookware you are using.

Flames larger than the bottom of the cookware will not result in faster heating and may be hazardous.

### Top-of-Range Cookware

**Aluminum:** Medium-weight cookware is recommended because it heats quickly and evenly. Most foods brown evenly in an aluminum skillet. Use saucepans with tight-fitting lids when cooking with minimum amounts of water.

**Cast-Iron:** If heated slowly, most skillets will give satisfactory results.

**Enamelware:** Under some conditions, the enamel of some cookware may melt. Follow cookware manufacturer's recommendations for cooking methods.

**Glass:** There are two types of glass cookware—those for oven use only and

those for top-of-range cooking (saucepans, coffee and teapots). Glass conducts heat very slowly.

**Heatproof Glass Ceramic:** Can be used for either surface or oven cooking. It conducts heat very slowly and cools very slowly. Check cookware manufacturer's directions to be sure it can be used on gas ranges.

**Stainless Steel:** This metal alone has poor heating properties and is usually combined with copper, aluminum or other metals for improved heat distribution. Combination metal skillets usually work satisfactorily if they are used with medium heat as the manufacturer recommends.



### Stove Top Grills

Do not use stove top grills on your sealed gas burners. If you use the stove top grill on the sealed gas burner, it will cause incomplete combustion and can result in exposure to carbon monoxide levels above allowable current standards.

This can be hazardous to your health.



Use a flat-bottomed wok.

### Wok This Way

We recommend that you use a 14-inch or smaller flat-bottomed wok. Make sure the wok bottom sits flat on the grate. They are available at your local retail store.

Only a flat-bottomed wok should be used.

Do not use a wok support ring. Placing the ring over the burner or grate may cause the burner to work improperly, resulting in carbon monoxide levels above allowable standards. This could be dangerous to your health.



### In Case of Power Failure

In case of a power failure, you can light the gas surface burners on your range with a match. Hold a lit match to the burner, then push in and turn the control knob to the **LITE** position. Use extreme caution when lighting burners this way.

Surface burners in use when an electrical power failure occurs will continue to operate normally.

# Using the oven controls.

Throughout this manual, features and appearance may vary from your model.

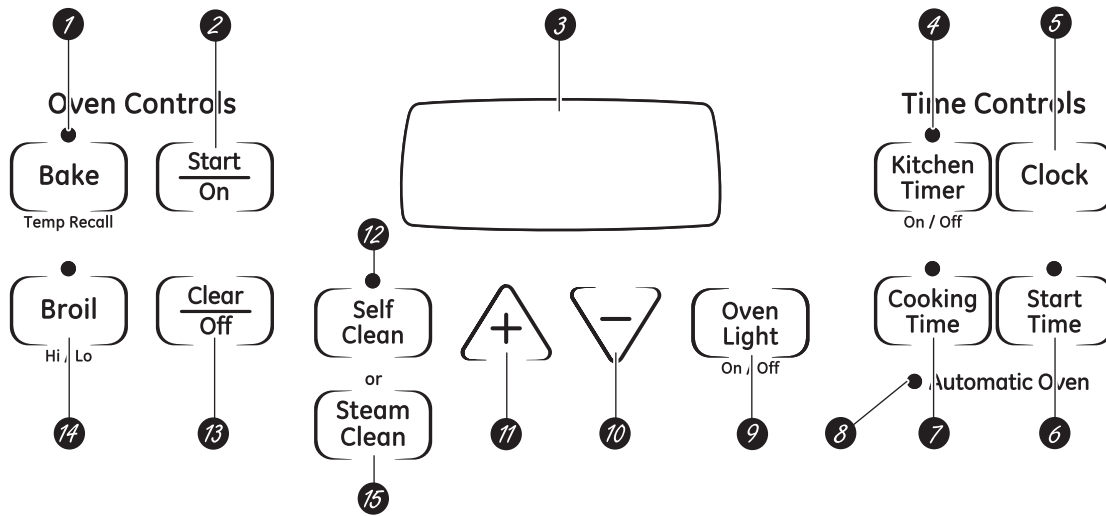

## Oven Control, Clock and Timer Features and Settings *(on some models)*



- 1** **Bake/Temp Recall Pad**  
Touch this pad to select the bake function.

**Bake Light**  
Flashes while in edit mode—you can change the oven temperature at this point. Glows when the oven is in bake mode.
- 2** **Start/On Pad**  
Must be touched to start any cooking or cleaning function.
- 3** **Display**  
Shows the time of day, oven temperature, whether the oven is in the bake, broil or self-cleaning mode and the times set for the timer or automatic oven operations. The display will show **PRE** while preheating. When the oven reaches the selected temperature, the oven control will beep and the display will show the oven temperature.

*If "F-" and a number or letter flash in the display and the oven control signals, this indicates a function error code.*

*If your oven was set for a timed oven operation and a power outage occurred, the clock and all programmed functions must be reset.*

*The time of day will flash in the display when there has been a power outage. Reset the clock.*

*If the function error code appears during the self-cleaning cycle, check the oven door latch. The latch handle may have been moved, even if only slightly, from the latched position. Make sure the latch is moved to the right as far as it will go.*

**Touch the Clear/Off pad.** Allow the oven to cool for one hour. Put the oven back into operation. If the function error code repeats, disconnect the power to the range and call for service.
- 4** **Kitchen Timer On/Off Pad**  
Touch this pad to select the timer feature. Then press the + and - pads to adjust the timer.

**Timer Light**  
Flashes while in edit mode—you can change the set time at this point. Glows when the timer has been activated. Flashes again when the time has run out until the control is reset.
- 5** **Clock Pad**  
To set the clock, press this pad twice and then press the + and - pads. The time of day will flash in the display when the oven is first turned on.
- 6** **Start Time Pad (on some models)**  
Use along with the **Cooking Time** or **Self Clean** pads to set the oven to start and stop automatically at a time you set.

**Start Time Light**  
Flashes while in edit mode—you can change the start time at this point. Glows when the function has been activated.
- 7** **Cooking Time Pad (on some models)**  
Touch this pad and then touch the + or - pads to set the amount of time you want your food to cook. The oven will shut off when the cooking time has run out.

**Cooking Time Light**  
Flashes while in edit mode—you can change the set time at this point. Glows when the function has been activated. Flashes again when the time has run out until the control is reset.





## Oven Control, Clock and Timer Features and Settings (on some models)

- 8** *Automatic Oven Light (on some models)*  
This lights anytime the oven has been programmed using the **Cooking Time** or **Start Time** functions.
- 9** *Oven Light On/Off Pad*  
Touch this pad to turn the oven light on or off.
- 10** *- Pad*  
Short taps to this pad will decrease the time or temperature by small amounts. Touch and hold the pad to decrease the time or temperature by larger amounts.
- 11** *+ Pad*  
Short taps to this pad will increase the time or temperature by small amounts. Touch and hold the pad to increase the time or temperature by larger amounts.
- 12** *Self Clean Pad (on some models)*  
Touch this pad to select the self-cleaning function. See the *Using the self-cleaning oven* section.  
  
*Clean Light*  
Flashes while in edit mode—you can change the length of time for the self-clean cycle at this point. Glows when the oven is in the self-clean cycle. After the self-clean cycle, the light will turn off. Unlatch the door.
- 13** *Clear/Off Pad*  
Touch this pad to cancel **ALL** oven operations except the clock and timer.
- 14** *Broil Hi/Lo Pad*  
Touch this pad to select the broil function.  
  
*Broil Light*  
Flashes while in edit mode—you can switch from **Hi** to **Lo Broil** at this point. Glows when the oven is in broil mode.  
  
*Indicator Lights (on some pads)*  
**EDIT** mode lasts several seconds after the last pad press. **Start Time** and **Cooking Time** will be the only pads lit if either of these options is selected. (Example: **Start Time** is selected with **Bake**—the **Start Time** pad will remain lit until the clock reaches the programmed time, at which point it will turn off and the **Bake/Temp Recall** pad light will light up.)
- 15** *Steam Clean Pad (on some models)*  
Touch this pad for easier cleaning, light soiling of the oven cavity or door.



## Oven Temperature Knob (on some models)

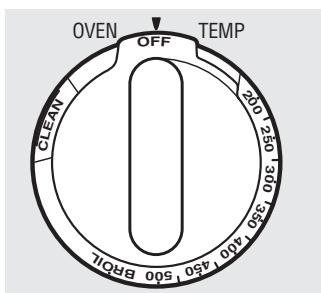

Appearance may vary.

Turn the **OVEN TEMP** knob to the setting you want.

- The oven cycling light comes on during cooking.

# Using the oven.

To avoid possible burns, place the shelves in the desired position before you turn the oven on.

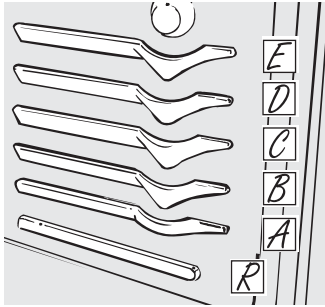

The oven has 5 shelf positions. It also has a special low shelf position (R) for extra large items, such as a large turkey.

## Before you begin...

The shelves have stop-locks, so that when placed correctly on the shelf supports (A through E), they will stop before coming completely out, and will not tilt.

When placing and removing cookware, pull the shelf out to the bump on the shelf support.

**CAUTION** When you are using a rack in the lowest position (R), you will need to use caution when pulling the rack out. We recommend that you pull the rack out several inches and then, using two pot holders, pull the rack out by holding the sides of it. The rack is low and you can be burned if you put your hand in the middle of the rack and pull all the way out.

**To remove a shelf,** pull it toward you, tilt the front end up and pull it out.

**To replace,** place the end of the shelf (stop-locks) on the support, tilt up the front and push the shelf in.

**NOTE:** The shelf is not designed to slide out at the special low shelf (R) position.

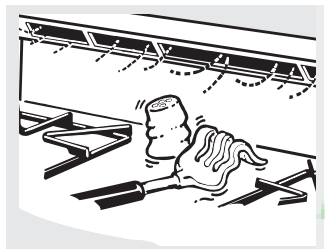

Plastic items on the cooktop may melt if left too close to the vent. Vent appearance and location vary.

## Upper Oven Vent

Your oven is vented through ducts at the rear of the range. Do not block these ducts when cooking in the oven—it is important that the flow of hot air from the oven and fresh air to the oven burner be uninterrupted. Avoid touching the vent openings or nearby surfaces during oven or broiler operation—they may become hot.

■ Handles of pots and pans on the cooktop may become hot if left too close to the vent.

■ Do not leave plastic or flammable items on the cooktop—they may melt or ignite if left too close to the vent.

■ Do not leave closed containers on the cooktop. The pressure in closed containers may increase, which may cause them to burst.

■ Metal items will become very hot if they are left on the cooktop, and could cause burns.

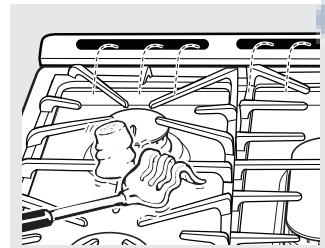

## Power Outage

The oven or broiler cannot be lit during a power failure. Gas will not flow unless the glow bar is hot.

If the oven is in use when a power failure occurs, the oven burner shuts off and cannot be re-lit until power is restored. This is because

the flow of gas is automatically stopped and will not resume when power is restored until the glow bar has reached operating temperature.

## Upper Oven Light

Touch the Oven Light pad on the upper control panel to turn the light on or off.

# Using the upper oven.

If your model has a door latch, do not lock the oven door with the latch during baking or roasting. The latch is used for self-cleaning only.



The oven has a special low shelf (R) position just above the oven bottom. Use it when extra cooking space is needed, for example, when cooking a large turkey. The shelf is not designed to slide out at this position.

## How to Set the Upper Oven for Baking or Roasting

Your oven is not designed for open-door cooking.

- 1 Touch the **Bake** pad.
- 2 Touch the number pads to set the desired temperature.
- 3 Touch the **Start** pad.

The word **ON** and **100°** will be displayed. As the oven heats up, the display will show the changing temperature. When the oven reaches the temperature you set, a tone will sound.

To change the oven temperature during **BAKE** cycle, press the **Bake** pad and then the number pads to get the new temperature.

- 4 Check food for doneness at minimum time on recipe. Cook longer if necessary.
- 5 Touch the **Clear/Off** pad when cooking is complete.

**NOTE:** A cooling fan may automatically turn on and off to cool internal parts. This is normal, and the fan may continue to run even after the oven is turned off.

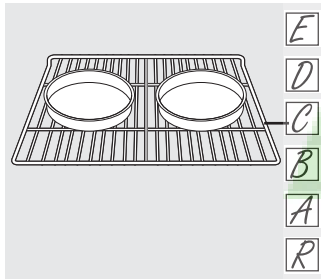

## Preheating and Pan Placement

To avoid possible burns, place the racks in the desired position before you turn on the oven.

Preheat the oven if the recipe calls for it. To preheat, set the oven at the correct temperature. Preheating is necessary for good results when baking cakes, cookies, pastry and breads.

Baking results will be better if baking pans are centered in the oven as much as possible. Pans should not touch each other or the walls of the oven. If you need to use two shelves, stagger the pans so one is not directly above the other, and leave approximately 1½" between pans, from the front, back and sides of the wall.

When baking on a single rack, use the rack position from the chart for your type of food. Baking results will be better if baking pans are centered in the oven as much as possible.

For ovens without a preheat indicator light or tone, preheat 10 minutes.

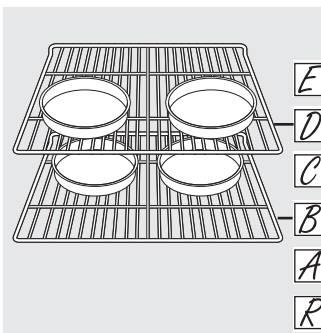

When baking four cake layers at a time, use racks B and D. Place the lower pans at the back of the rack and the upper pans to the front of the rack shown so that one pan is not directly above another.

## Using the upper oven.

---

### Aluminum Foil

Do not use aluminum foil to line oven bottoms. The foil will trap heat below and upset the performance of the oven. Foil can melt and permanently damage the oven bottom. Damage from improper use of aluminum foil is not covered by the product warranty.

Foil may be used to catch spills by placing a

sheet on a lower rack, several inches below the food. Do not use more foil than necessary and never entirely cover an oven rack with aluminum foil. Keep foil at least 1-1/2" from oven walls to prevent poor heat circulation.

---

### Oven Moisture

As your oven heats up, the temperature change of the air in the oven may cause water droplets to form on the door glass. These droplets are harmless and will evaporate as the oven continues to heat up.

---

If your model has a door latch, do not lock the oven door with the latch during broiling. The latch is used for self-cleaning only.

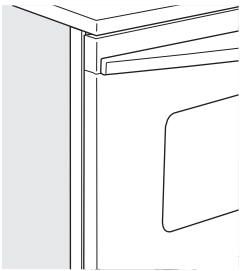

Close the door. Always broil with the door closed.

### How to Set the Upper Oven for Broiling

- 1 Place the meat or fish on a broiler grid in a broiler pan.
  - 2 Follow suggested shelf positions in the *Broiling Guide*.
  - 3 The oven door must be closed during broiling.
  - 4 Touch the **Broil Hi/Lo** pad once for **Hi Broil**.  
To change to **Lo Broil**, touch the **Broil Hi/Lo** pad again.
  - 5 Touch the **Start** pad.
  - 6 When broiling is finished, touch the **Clear/Off** pad.
- Serve the food immediately, and leave the pan outside the oven to cool during the meal for easiest cleaning.
- Use Lo Broil to cook foods such as poultry or thick cuts of meat thoroughly without over-browning them.

**Broiling Guide**

The size, weight, thickness, starting temperature and your preference of doneness will affect broiling times. This guide is based on meats at refrigerator temperature.

†The U.S. Department of Agriculture says "Rare beef is popular, but you should know that cooking it to only 140°F. means some food poisoning organisms may survive." (Source: *Safe Food Book, Your Kitchen Guide*, USDA Rev. June 1985.)

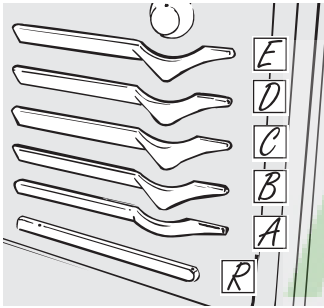

The oven has 5 shelf positions.

Food	Doneness	Type or Thickness	Broil Setting	Rack Position*	Comments
Beef	Rare - Medium Rare (140°F-150°F)	Steaks- 1" thick	Hi	E	Steaks less than 1" thick are difficult to cook rare. They may cook through before browning.
	Medium (160°F)	Steaks- 3/4" to 1" thick	Hi	D-E	
	Well Done (170°F)	Steaks- 3/4" to 1" thick	Hi	D	To avoid curling, slash fat at 1" intervals.
	Medium (160°F)	Ground Beef Patties - 1/2" to 3/4" thick	Hi	D-E	
	Well Done (170°F)	Ground Beef Patties - 1/2" to 3/4" thick	Hi	D	
Chicken		Breast, boneless	Hi	C	Broil skin side down first.
		Breast, bone-in	Hi	C	
Fish fillets		1/2" to 1" thick	Hi	D	Handle and turn very carefully
			Lo	D	
Pork Chops	Well Done (170°F)	3/4" thick	Hi	D	To avoid curling, slash fat at 1" intervals.

\*Due to the variety of meats and cuts available, you may select alternate rack positions based on personal preference of doneness and external searing. See illustration for description of rack positions.

800-570-3355

## Using the clock and timer. (on some models)

Not all features are on all models.

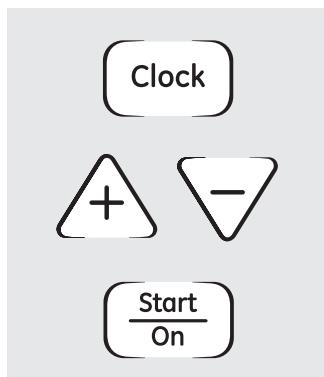

Make sure the clock is set to the correct time of day.

### To Set the Clock

The clock must be set to the correct time of day for the automatic oven timing functions to work properly. The time of day cannot be changed during a delayed cooking or a delayed self-cleaning cycle.

- 1 Touch the **Clock** pad twice.
- 2 Touch the + or - pads.

If the + or - pads are not touched within one minute after you touch the **Clock** pad, the display reverts to the original setting. If this happens, touch the **Clock** pad twice and reenter the time of day.

- 3 Touch the **Start/On** pad until the time of day shows in the display. This enters the time and starts the clock.

To check the time of day when the display is showing other information, simply touch the **Clock** pad. The time of day shows until another pad is touched.

### To Turn Off the Clock Display

If you have several clocks in your kitchen, you may wish to turn off the time of day clock display on your range.

- 1 Touch the **Clock** pad once to turn off the time of day display. Although you will not be able to see it, the clock maintains the correct time of day.

- 2 Touch the **Clock** pad twice to recall the clock display.

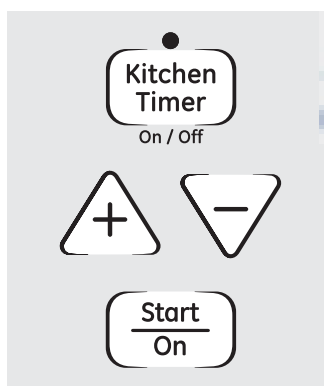

The timer is a minute timer only.  
The Clear/Off pad does not affect the timer.

### To Set the Timer

The timer does not control oven operations.  
The maximum setting on the timer is 9 hours and 59 minutes.

- 1 Touch the **Kitchen Timer On/Off** pad.
- 2 Touch the + or - pads until the amount of time you want shows in the display. The maximum time that can be entered in minutes is 59. Times more than 59 minutes should be changed to hours and minutes.

- 3 Touch the **Start/On** pad. The time will start counting down, although the display does not change until one minute has passed.

- 4 When the timer reaches :00, the control will beep 3 times followed by one beep every 6 seconds until the **Kitchen Timer On/Off** pad is touched.

If you make a mistake, touch the **Kitchen Timer On/Off** pad and begin again.

Not all features are on all models.

### To Reset the Timer

If the display is still showing the time remaining, you may change it by touching the **Kitchen Timer On/Off** pad and then touching the + or - pads until the time you want appears in the display.

If the remaining time is not in the display (clock, start time or cooking time are in the display), recall the remaining time by touching the **Kitchen Timer On/Off** pad and then touching the + or - pads to enter the new time you want.

### To Cancel the Timer

Touch the **Kitchen Timer On/Off** pad twice.

### End of Cycle Tones (on some models)

Clear the tones by pressing the pad of the function you are using.



or



**AjMadison**  
Your Appliance Authority

### Power Outage

If a flashing time is in the display, you have experienced a power failure. Reset the clock.

To reset the clock, touch the **Clock** pad. Enter the correct time of day by touching the + or - pads. Touch the **Start/On** pad.

800-570-3355

## Using the timed baking and roasting features. (on some models)

Do not lock the oven door with the latch during timed cooking. The latch is used for self-cleaning only.

**NOTE:** Foods that spoil easily—such as milk, eggs, fish, stuffings, poultry and pork—should not be allowed to sit for more than 1 hour before or after cooking. Room temperature promotes the growth of harmful bacteria. Be sure that the oven light is off because heat from the bulb will speed harmful bacteria growth.

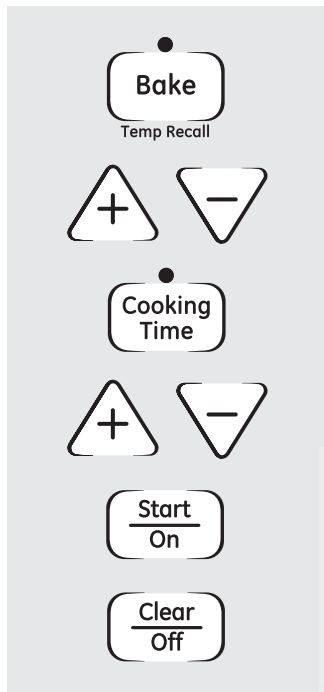

### How to Set an Immediate Start and Automatic Stop

The oven will turn on immediately and cook for a selected length of time. At the end of the cooking time, the oven will turn off automatically.

- 1 Touch the **Bake** pad.
- 2 Touch the + or - pads to set the oven temperature.
- 3 Touch the **Cooking Time** pad.

**NOTE:** If your recipe requires preheating, you may need to add additional time to the length of the cooking time.

- 4 Touch the + or - pads to set the baking time.

The cooking time that you entered will be displayed. (If you select **Cooking Time** first and then adjust the **Bake Temperature**, the oven temperature will be displayed instead.)

- 5 Touch the **Start/On** pad.

The display shows either the oven temperature that you set or the cooking time countdown. (The display starts with **PRE** if showing the oven temperature.)

The oven will continue to cook for the programmed amount of time, then turn off automatically.

- 6 Touch the **Clear/Off** pad to clear the display if necessary.

Remove the food from the oven. Remember, even though the oven shuts off automatically, foods continue cooking after controls are off.

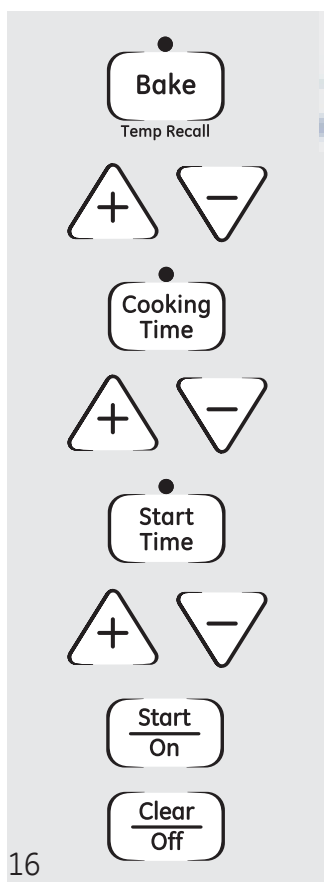

### How to Set a Delayed Start and Automatic Stop

The oven will turn on at the time of day you set, cook for a specific length of time and then turn off automatically.

Make sure the clock shows the correct time of day.

- 1 Touch the **Bake** pad.
- 2 Touch the + or - pads to set the oven temperature.
- 3 Touch the **Cooking Time** pad.
- 4 Touch the + or - pads to set the desired length of cooking time.
- 5 Touch the **Start Time** pad.
- 6 Touch the + or - pads to set the time of day you want the oven to turn on and start cooking.
- 7 Touch the **Start/On** pad.

**NOTE:** An attention tone will sound if you are using timed baking and do not touch the **Start/On** pad.

**NOTE:** If you would like to check the times you have set, touch the **Start Time** pad to check the start time you have set or touch the **Cooking Time** pad to check the length of cooking time you have set.

When the oven turns on at the time of day you have set, the display will show **PRE** until it reaches the selected temperature, and then it will display the oven temperature.

At the end of cooking time, the oven will turn off and the end of cycle tone will sound.

- 8 Touch the **Clear/Off** pad to clear the display if necessary.

Remove the food from the oven. Remember, even though the oven shuts off automatically, foods continue cooking after controls are off.



## Special features of your oven control. *(on some models)*

GEAppliances.com

Your new touch pad control has additional features that you may choose to use. The following are the features and how you may activate them.

The special feature modes can only be activated while the display is showing the time of day. They remain in the control's memory until the steps are repeated.

When the display shows your choice, touch the Start/On pad. The special features will remain in memory after a power failure.

**NOTE:** The Sabbath feature and the Thermostat Adjustment feature are also Special Features, but they are addressed separately in the following sections.

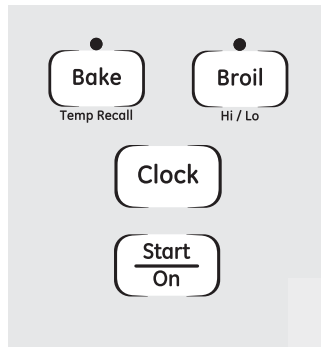

### 12 Hour Shut-Off

With this feature, should you forget and leave the oven on, the control will automatically turn off the oven after 12 hours during baking functions or after 3 hours during a broil function.

If you wish to turn **OFF** this feature, follow the steps below.

1 Touch the **Bake** and **Broil Hi/Lo** pads at the same time for 3 seconds until the display shows **SF**.

2 Touch the **Clock** pad. The display will show **ON** (12 hour shut-off). Touch the **Clock** pad repeatedly until the display shows **OFF** (no shut-off).

3 Touch the **Start/On** pad to activate the no shut-off and leave the control set in this special features mode.

**AjMadison**  
Your Appliance Authority™  
800-570-3355

# Using the Sabbath feature. (on some models)

(Designed for use on the Jewish Sabbath and Holidays)

The Sabbath feature can be used for baking/roasting only. It cannot be used for broiling, self-cleaning or delay start cooking.

**NOTE:** The oven light comes on automatically (on some models) when the door is opened and goes off when the door is closed. The bulb may be removed. See the Oven Light Replacement section. On models with a light switch on the control panel, the oven light may be turned on and left on.

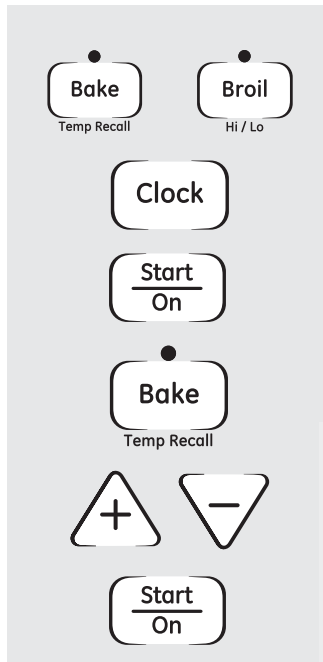

## How to Set for Regular Baking/Roasting

**NOTE:** To understand how the oven control works, practice using regular baking (non-Sabbath) before entering Sabbath mode.

Make sure the clock shows the correct time of day and the oven is off.

- 1 Touch and hold both the **Bake** and **Broil Hi/Lo** pads, at the same time, until the display shows **SF**.
- 2 Tap the **Clock** pad until **SAb** appears in the display.
- 3 Touch the **Start/On** pad and  $\supset$  will appear in the display.
- 4 Touch the **Bake** pad. No signal will be given.
- 5 The preset starting temperature will automatically be set to 350°. Tap the + or - pads to increase or decrease the temperature in 25° increments. The temperature can be set between 170° and 550°. No signal or temperature will be given.
- 6 Touch the **Start/On** pad.

- 7 After a random delay period of approximately 30 seconds to 1 minute,  $\supset$  will appear in the display indicating that the oven is baking/roasting. If  $\supset$  doesn't appear in the display, start again at Step 4.

To adjust the oven temperature, touch the **Bake** pad and tap the + or - pads to increase or decrease the temperature in 25° increments. Touch the **Start/On** pad.

**NOTE:** The **Clear/Off** and **Cooking Time** pads are active during the Sabbath feature.

When the display shows  $\supset$  the oven is set in Sabbath. When the display shows  $\supset$  the oven is baking/roasting.

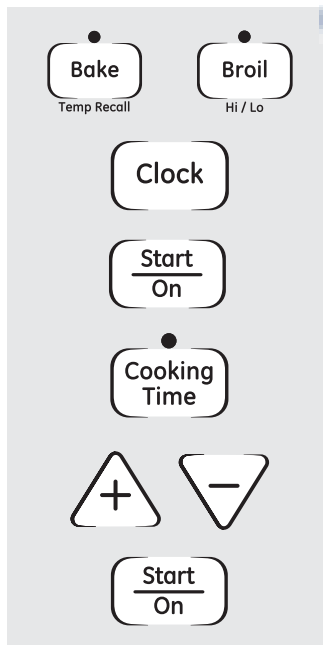
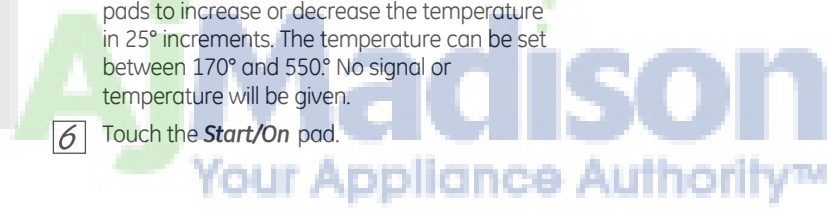

## How to Set for Timed Baking/Roasting—Immediate Start and Automatic Stop

**NOTE:** To understand how the oven control works, practice using regular (non-Sabbath) Immediate Start and Automatic Stop before entering the Sabbath mode.

Make sure the clock shows the correct time of day and the oven is off.

- 1 Touch and hold both the **Bake** and **Broil Hi/Lo** pads, at the same time, until the display shows **SF**.
- 2 Tap the **Clock** pad until **SAb** appears in the display.
- 3 Touch the **Start/On** pad and  $\supset$  will appear in the display.
- 4 Touch the **Cooking Time** pad.
- 5 Touch the + or - pads to set the desired length of cooking time between 1 minute and 9 hours and 59 minutes. The cooking time that you entered will be displayed.
- 6 Touch the **Start/On** pad.
- 7 Touch the **Bake** pad. No signal will be given.

- 8 The preset starting temperature will automatically be set to 350°. Tap the + or - pads to increase or decrease the temperature in 25° increments. The temperature can be set between 170° and 550°. No signal or temperature will be given.

- 9 Touch the **Start/On** pad.

- 10 After a random delay period of approximately 30 seconds to 1 minute,  $\supset$  will appear in the display indicating that the oven is baking/roasting. If  $\supset$  doesn't appear in the display, start again at Step 7.

To adjust the oven temperature, touch the **Bake** pad and tap the + or - pads to increase or decrease the temperature in 25° increments. Touch the **Start/On** pad.

When cooking is finished, the display will change from  $\supset$  to  $\supset$ , indicating that the oven has turned OFF but is still set in Sabbath. Remove the cooked food.

When the display shows  $\supset$  the oven is set in Sabbath. When the display shows  $\supset$  the oven is baking/roasting.

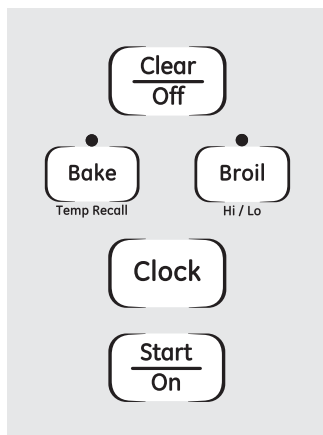

### How to Exit the Sabbath Feature

- 1 Touch the **Clear/Off** pad.
- 2 If the oven is cooking, wait for a random delay period of approximately 30 seconds to 1 minute, until only  $\supset$  is in the display.
- 3 Touch and hold both the **Bake** and **Broil Hi/Lo** pads, at the same time, until the display shows **SF**.
- 4 Tap the **Clock** pad until **ON** or **OFF** appears in the display. **ON** indicates that the oven will automatically turn off after 12 hours. **OFF** indicates that the oven will not automatically turn off. See the Special features section for an explanation of the *12 Hour Shut-Off* feature.
- 5 Touch the **Start/On** pad.

**NOTE:** If a power outage occurred while the oven was in Sabbath, the oven will automatically turn off and stay off even when the power returns. The oven control must be reset.

  
**AjMadison**  
 Your Appliance Authority™  
**800-570-3355**

## Adjust the oven thermostat—Do it yourself!

GEAppliances.com

You may find that your new oven cooks differently than the one it replaced. Use your new oven for a few weeks to become more familiar with it. If you still think your new oven is too hot or too cold, you can adjust the thermostat yourself.

Do not use thermometers, such as those found in grocery stores, to check the temperature setting of your oven. These thermometers may vary 20–40 degrees.

**NOTE:** This adjustment will not affect the broiling or the self-cleaning temperatures. The adjustment will be retained in memory after a power failure.

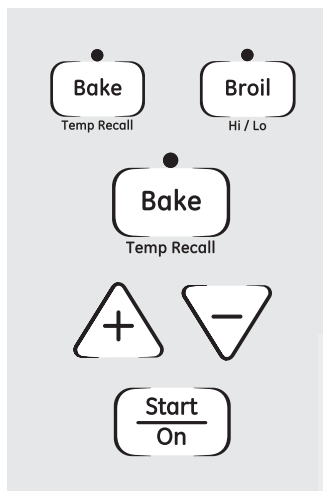

### To Adjust the Thermostat (on some models)

- 1 Touch the **Bake** and **Broil Hi/Lo** pads at the same time for 3 seconds until the display shows SF.
- 2 Touch the **Bake** pad. A two-digit number shows in the display.
- 3 The oven temperature can be adjusted up to (+) 35°F hotter or (–) 35°F cooler. Touch the + pad to increase the temperature in 1-degree increments.  
Touch the – pad to decrease the temperature in 1-degree increments.
- 4 When you have made the adjustment, touch the **Start/On** pad to go back to the time-of-day display. Use your oven as you would normally.

**NOTE:** This adjustment will not affect the broiling or self-cleaning temperatures. It will be retained in memory after a power failure.

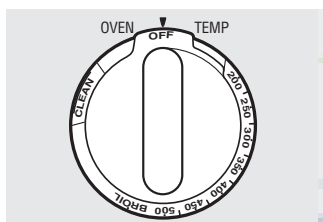

Front of OVEN TEMP knob  
(knob appearance may vary)

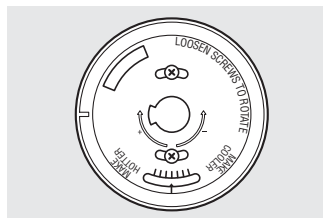

Back of OVEN TEMP knob  
(knob appearance may vary)

### To Adjust the Thermostat (on models with an OVEN TEMP Knob)

- 1 Pull the **OVEN TEMP** knob off the range and look at the back side. To make an adjustment, loosen (approximately one turn), but do not completely remove, the two screws on the back of the knob.  
Each click will change the oven temperature approximately 10°F. (Range is plus or minus 60°F from the arrow.) We suggest that you make the adjustment one click from the original setting and check oven performance before making any additional adjustments.
- 2 With the back of the knob facing you, hold the outer edge of the knob with one hand and turn the front of the knob with the other hand.  
To increase the oven temperature, move the top screw toward the right. You'll hear a click for each notch you move the knob.  
To decrease the oven temperature, move the top screw toward the left.
- 3 After the adjustment is made, retighten screws so they are snug, but be careful not to overtighten.
- 4 Replace the knob, matching the flat area of the knob to the shaft, and check performance.

## The type of margarine will affect baking performance!

Most recipes for baking have been developed using high-fat products such as butter or margarine (80% fat). If you decrease the fat, the recipe may not give the same results as with a higher-fat product.

Recipe failure can result if cakes, pies, pastries, cookies or candies are made with low-fat spreads. The lower the fat content of a spread product, the more noticeable these differences become.

Federal standards require products labeled “margarine” to contain at least 80% fat by weight. Low-fat spreads, on the other hand, contain less fat and more water. The high moisture content of these spreads affects the texture and flavor of baked goods. For best results with your old favorite recipes, use margarine, butter or stick spreads containing at least 70% vegetable oil.

## **⚠️ WARNING**

**FOOD POISON HAZARD: Bacteria may grow in food temperatures below 140F.**

- Always start with hot food. Do not use WARM settings to heat cold food.
- Do not warm food for more than 2 hours.

The warming drawer will keep hot, cooked foods at serving temperature. Always start with hot food. Do not use to heat cold food other than crisping crackers, chips or dry cereal. Failure to follow these instructions may result in foodborne illness.

### Control Knob *(on models equipped with a knob)*

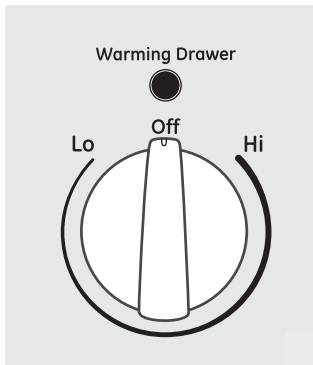

Push and turn the control knob to any desired setting.

#### NOTES:

- The warming drawer cannot be used during a self-clean cycle.
- The warming drawer has three settings: 1, 2 and 3. These settings maintain different temperature levels in the warming drawer.
- On some models, if using the oven at the same time as the warming drawer, only the oven settings will be displayed.

Number Pad	Setting
1	Lo (pies)
2	Med (casseroles)
3	Hi (meats)

### When Using the Warming Drawer

The warming drawer will keep hot, cooked foods at serving temperature. Always start with hot food. Do not use to heat cold food other than crisping crackers, chips or dry cereal.

**Allow approximately 25 minutes for the warming drawer to preheat.**

- Do not put liquid or water in the warming drawer.
- All foods placed in the warming drawer should be covered with a lid or aluminum foil. When warming pastries or breads, the cover should be vented to allow moisture to escape.

Food should be kept hot in its cooking container or transferred to a heat-safe serving dish.

**NOTE:** Plastic containers or plastic wrap will melt if in direct contact with the drawer, pan or a hot utensil. Melted plastic may not be removable and is not covered under your warranty.

- Remove serving spoons, etc., before placing containers in warming drawer.

### Temperature Selection Chart

To keep several different foods hot, set the control to the food needing the highest setting.

- The temperature, type and amount of food, and the time held will affect the quality of the food.
- Repeated opening of the drawer allows the hot air to escape and the food to cool.
- With large loads, it may be necessary to use a higher warming drawer setting and cover some of the cooked food items.

- Do not use plastic containers or plastic wrap.

FOOD TYPE	CONTROL SETTING
Casserole	MED/2
Chili	HI/3
Pizza	MED/2
Potatoes, baked	HI/3
Tortilla Chips	LO/1
Waffles	LO/1

## Using the electric warming drawer. *(on some models)*

---

### **To Crisp Stale Items**

- Place food in low-sided dishes or pans.
- Preheat on **LO/1** setting.
- Check crispness after 45 minutes. Add time as needed.

---

### **To Warm Serving Bowls and Plates**

To warm serving bowls and plates, set the control on **LO/1**.

#### **⚠ CAUTION**

*Dishes will be hot. Use pot holders or mitts when removing hot dishes.*

- Use only heat-safe dishes.

- If you want to heat fine china, please check with the manufacturer of the dishes for their maximum heat tolerance.
- You may warm empty serving dishes while preheating the drawer.



# Using the self-cleaning upper oven.

If your model has a door latch, never force the latch handle. Forcing the handle will damage the door lock mechanism. The oven door must be closed and all controls set correctly for the cycle to work properly.

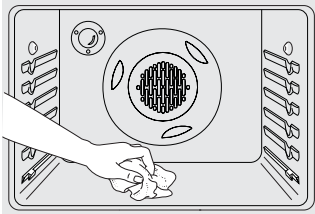

Wipe up heavy soil on the oven bottom.

**DO NOT** hand clean gasket. (On some models, the gasket is on the inner door.

**DO** hand clean inside door frame and glass.

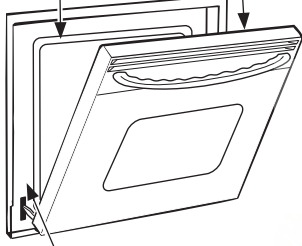

**DO** hand clean oven frame.

## Before a Clean Cycle

For the first self-clean cycle, we recommend venting your kitchen with an open window or using a ventilation fan or hood.

Remove any broiler pan, broiler grid, all cookware, probe and any aluminum foil from the oven—they cannot withstand the high cleaning temperatures.

### NOTE:

- If your oven is equipped with nickel oven shelves, remove them before you begin the self-clean cycle.
- If your oven is equipped with gray porcelain-coated oven shelves, they may be left in the oven during the self-clean cycle.

Soil on the front frame of the range and outside the gasket on the front frame will need to be cleaned by hand. Clean these areas with hot water, soap-filled scouring pads or cleansers such as Soft Scrub®. Rinse well with clean water and dry. Wipe off the flat inner door and glass with soapy water and sponge.

Do not clean the gasket. The fiberglass material of the front frame gasket cannot withstand abrasion. It is essential for the gasket to remain intact. If you notice it becoming worn or frayed, replace it.

## Wipe up any heavy spillovers on the oven bottom.

Make sure the oven light bulb cover is in place and the oven light is off.

**IMPORTANT:** The health of some birds is extremely sensitive to the fumes given off during the self-cleaning cycle of any range. Move birds to another well ventilated room.

**NOTE:** Use caution when opening the upper oven after the self-clean cycle has ended. The oven may still be hot.

## How to Set the Oven for Cleaning (on models with an OVEN TEMP Knob)

Follow the directions in the Before a Clean Cycle section.

- 1 Latch the door.
- 2 Turn the **OVEN TEMP** knob to **CLEAN**.

The Clean Time is 4 hours and 20 minutes. The self-clean light will come on and stay on until the self-clean cycle is complete.

The oven shuts off automatically when the clean cycle is complete.

- 3 After a clean cycle, turn the **OVEN TEMP** knob to **OFF** and slide the latch handle to the left as far as it will go.

To cancel self-clean cycle, turn **OVEN TEMP** knob to off and slide latch to left as far as it will go. Wait until self-clean light stops blinking. Use oven as desired.

**NOTE:** Never force the latch. If the oven is too hot, you will not be able to slide the latch. Allow the oven to cool.

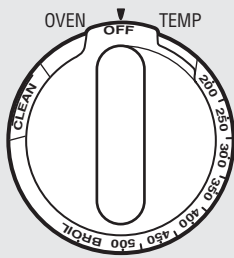

## How to Set the Oven for Cleaning

Follow the directions in the Before a Clean Cycle section.

- 1 Latch the door.  
**NOTE:** Never force the latch. If the oven is too hot, you will not be able to slide the latch. Allow the oven to cool.
- 2 Touch the **Self Clean** pad.
- 3 Touch the + or – pads until the desired **Clean Time** is displayed.

The **Clean Time** is normally 4 hours and 20 minutes. You can change the **Clean Time** to any time between 3 and 5 hours, depending on the amount of soil in your oven.

- 4 Touch the **Start/On** pad.

The self-clean cycle will automatically begin after **CLEAN** is displayed and the time countdown appears in the display.

While the oven is self-cleaning, you can touch the **Clock** pad to display the time of day. To return to the clean countdown, touch the **Self Clean** pad.

The oven shuts off automatically when the clean cycle is complete, and **0:00** will flash in the display.

- 5 Slide the latch handle to the left as far as it will go and open the door.

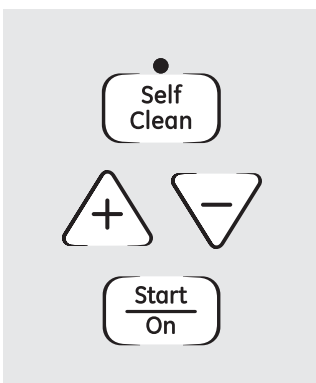

## Care and cleaning of the range.

The oven door must be closed and all controls set correctly for the cycle to work properly.

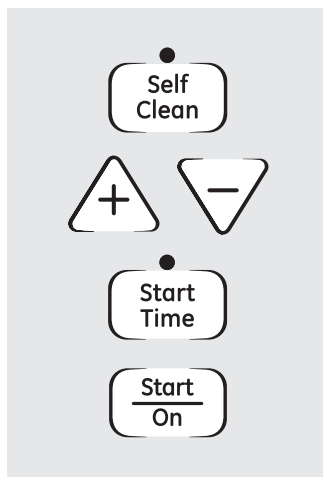

### How to Delay the Start of Cleaning (on some models)

You can set the oven control to delay-start the oven, clean for a specific length of time and then turn off automatically.

Make sure the clock shows the correct time of day.

Follow the directions in the *Before a Clean Cycle* section.

1 Latch the door.

**NOTE:** Never force the latch. If the oven is too hot, you will not be able to slide the latch. Allow the oven to cool.

2 Touch the **Self Clean** pad.

3 Touch the + or - pads to set the **Clean Time**.

The Clean Time is preset for 4 hours and 20 minutes. You can change the Clean Time to any time between 3 and 5 hours, depending on the amount of soil in your oven. If a different Clean Time is desired, touch the + or - pads until the desired Clean Time is displayed.

4 Touch the **Start Time** pad  
Change the Start Time by touching the + or - pads. The start time will appear in the display.

5 Touch the **Start/On** pad.

The self-clean cycle will automatically begin at the time set.

While the oven is self-cleaning, you can touch the **Clock** pad to display the time of day. To return to the clean countdown, touch the **Self Clean** pad.

The oven shuts off automatically when the clean cycle is complete, and **0:00** will flash in the display.

6 Slide the latch handle to the left as far as it will go and open the door.

### To Stop a Clean Cycle (on some models)

Touch the **Clear/Off** pad.

Wait until the oven has cooled below the locking temperature to unlatch the door. You will not be able to open the door right away unless the oven has cooled below the locking temperature.

### After a Clean Cycle

You may notice some white ash in the oven. Wipe it up with a damp cloth after the oven cools.

*If white spots remain, remove them with a soap-filled scouring pad and rinse thoroughly with a vinegar and water mixture.*

These deposits are usually a salt residue that cannot be removed by the clean cycle.

If the oven is not clean after one clean cycle, repeat the cycle.

■ You cannot set the oven for cooking until the oven is cool enough for the door to unlock.

■ While the oven is self-cleaning, you can touch the **Clock** pad to display the time of day. To return to the clean countdown, touch the **Cooking Time** pad.

■ If the shelves become hard to slide, apply a small amount of vegetable oil or cooking oil to a paper towel and wipe the edges of the oven shelves with the paper towel.



Be sure electrical power is off and all surfaces are cool before cleaning any part of the range.

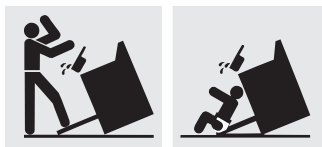

**⚠ WARNING**

If your range is removed for cleaning, servicing or any reason, be sure the anti-tip device is reengaged properly when the range is replaced. Failure to take this precaution could result in tipping of the range and cause injury.

To check if the bracket is installed and engaged properly, carefully tip the range forward. The bracket should stop the range within 4 inches. If it does not, the bracket must be reinstalled.

If the range is pulled from the wall for any reason, always repeat this procedure to verify the range is properly secured by the anti-tip bracket.

If your range has no anti-tip bracket, call 1.800.626.8774 to receive one at no cost.

**Sealed Burner Assemblies** (on some models)

Turn all controls **OFF** before removing the burner parts.

The round side burner caps and burner heads can be lifted off, making them easy to clean. The electrodes are not removable.

The oval center burner head and cap assembly can be lifted off, making it easy to clean. The burner electrode is not removable.

The tri-ring burner inner cap can be lifted off for cleaning, the outer cap and base assembly can be lifted off the cooktop as one piece for cleaning purposes.

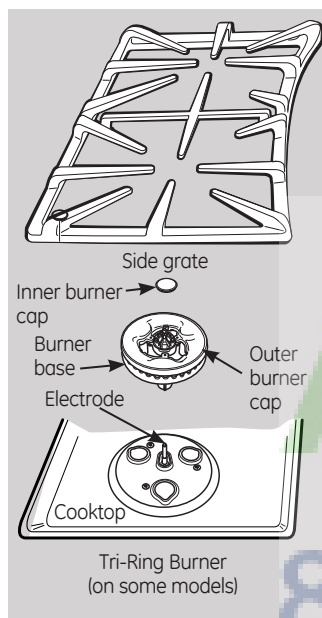

**⚠ CAUTION**

Do not operate the cooktop without all burner parts and grates in place.

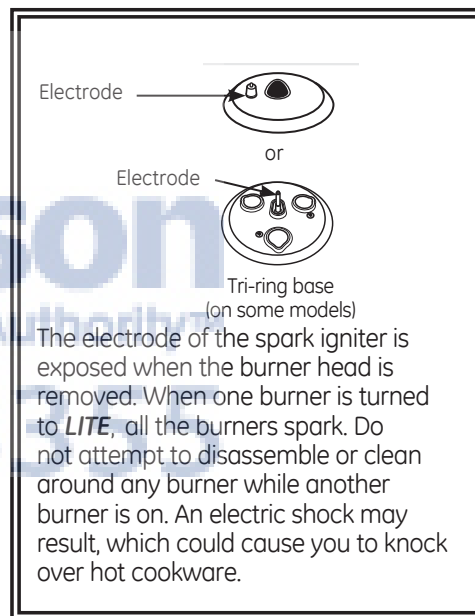

The electrode of the spark igniter is exposed when the burner head is removed. When one burner is turned to **LITE**, all the burners spark. Do not attempt to disassemble or clean around any burner while another burner is on. An electric shock may result, which could cause you to knock over hot cookware.

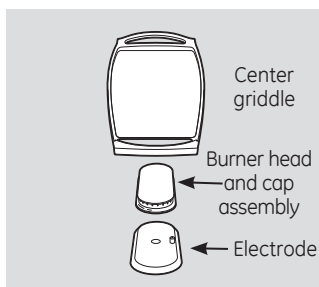

**⚠ CAUTION**

Do not remove tri-ring or bridge burner cap from head.

The tri-ring or bridge burner head and cap assembly can be lifted off, making it easy to clean. The electrode is not removable.

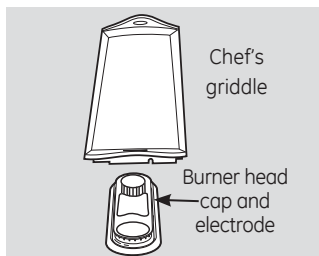

## Care and cleaning of the range.

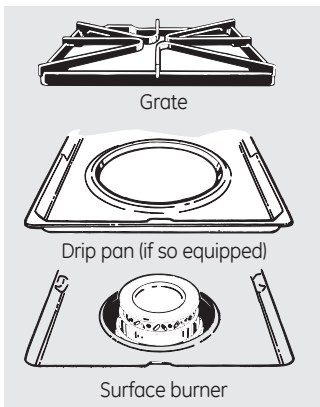

### ⚠ CAUTION:

Do not operate the cooktop without all burner parts, drip pans (if so equipped) and grates in place.

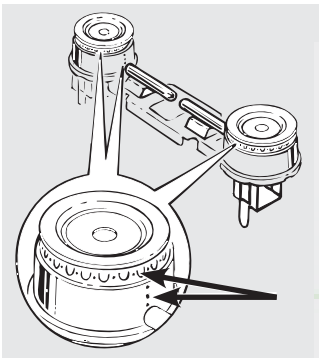

Clean these holes thoroughly on each burner.

### Standard Twin Burner Assemblies *(on some models)*

For cleaning information on sealed burners, see section below. Sealed burner cooktops do not lift up.

On models with standard twin burners, the cooktop lifts up for easy access.

Turn all controls **OFF** before removing burner parts and drip pans (if so equipped).

The burner grates and drip pans (if so equipped) can be lifted off, making them easy to clean.

The holes in the surface burners of your range must be kept clean at all times for proper ignition and an even, unhampered flame.

You should clean the surface burners routinely, especially after bad spillovers, which could clog these holes.

Wipe off surface burners. If heavy spillover occurs, remove the surface burners from the range. Burners lift out for cleaning. Lift up the cooktop and then lift out the surface burners.

To remove burned-on food, soak the surface burner in a solution of mild liquid detergent and hot water. Soak the surface burner for 20 to 30 minutes.

For more stubborn stains, use a cleanser like Soft Scrub® brand or Bon Ami® brand. Rinse well to remove any traces of the cleanser that might clog the surface burner openings.

Do not use steel wool because it will clog the surface burner openings and scratch the surface burners. If the holes become clogged, clean them with a sewing needle or twist-tie.

Before putting the surface burner back, shake out excess water and then dry it thoroughly by setting it in a warm oven for 30 minutes. Then place it back in the range, making sure it is properly seated and level.

Check the flame pattern of each burner. If the flames are "jumpy" (not steady), clean the holes again with a sewing needle or twist-tie.

Madison  
Your Appliance Authority™  
800-570-3355

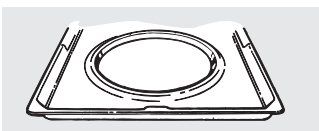

### Drip Pans *(if so equipped)*

Remove the grates and lift out the drip pans. Drip pans can be cleaned in a dishwasher or by hand.

When replacing the drip pans, make sure they are in the correct position.

Place them in a covered container. Add 1/4 cup ammonia and let soak several hours or overnight. Wash, rinse well and dry.

**⚠ CAUTION:** Do not clean the drip pans in a self-cleaning oven.

### Burner Caps, Bases and Heads

Before removing the burner caps and heads (on some models), remember their size and location. Replace them in the same location after cleaning.

**NOTE:** Do not use steel wool or scouring powders to clean the burner parts.

#### Burner caps

Lift off when cool. Wash burner caps in hot, soapy water and rinse with clean water. You may scour with a plastic scouring pad to remove burned-on food particles.



Burner cap is properly seated.

Burner cap is NOT properly seated.

Burner heads (on some models)

The burner heads (on some models) are removable. Simply lift them off the range for cleaning.

Tri-ring head (on some models)

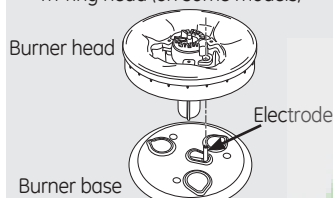

Make sure the ring in the burner head is positioned over the electrode and that the burner head is fully inserted inside the burner base. A small gap between the base and head is normal.

Front-right head (on some models), front-left head, back-right head and back-left head

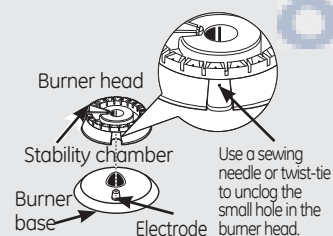

Make sure the slot in the burner head is positioned over the electrode.

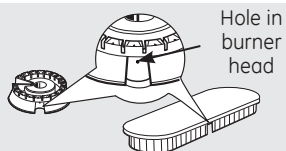

The oval burner head/cap assembly is removable. Simply lift it off the range for cleaning. Use a sewing needle or twist-tie to unclog the small hole in the burner heads.

#### Tri-ring burner (on some models)

The outer cap on the tri-ring burner is not removable. Only the center round cap may be removed for cleaning.

To clean the burner bases, use soapy water and a plastic scouring pad. Wipe clean with a damp cloth.

Make sure that no water gets into the burner bases. Allow them to dry fully before using.

#### Burner Heads (on some models) and Oval (Center) Burner Head/Cap Assembly

The burner heads and the oval burner head/cap assembly are removable. Simply lift them off the range for cleaning.

For proper ignition, make sure the small hole in the section that fits over the electrode is kept open. A sewing needle or wire twist-tie works well to unclog it.

The slits in the burner heads must be kept clean at all times for an even, unhampered flame.

Clogged or dirty burner ports or electrodes will not allow the burner to operate properly.

Any spill on or around an electrode must be carefully cleaned. Take care to not hit an electrode with anything hard or it could be damaged.

Clean the burner heads routinely, especially after bad spillovers, which could clog the openings. Lift off when cool.

To remove burned-on food, soak the burner heads in a solution of mild liquid detergent and hot water for 20–30 minutes. For more stubborn stains, use a toothbrush.

#### After cleaning

Before putting the burner caps, heads (on some models) and oval head/cap assembly back, shake out excess water and then dry them thoroughly by setting in a warm oven for 30 minutes.

#### Replacement Burner Heads (on some models)

Replace burner heads over the electrodes on the cooktop, in the correct locations according to their size. There is one small, one medium, one large and one extra-large burner head.

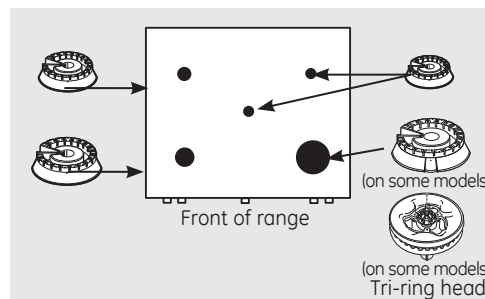

Make sure the slot or hole (depending on model) in the burner head is positioned over the electrode.

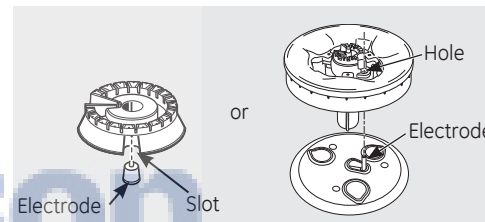

#### Oval (Center) Burner Head/Cap Assembly

Replace the oval (center) head/cap assembly over the electrode on the cooktop.

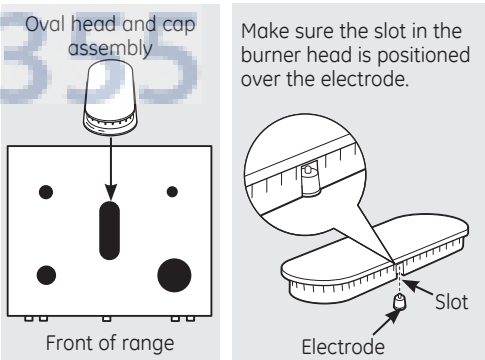

#### Caps

Replace the matching size caps onto the burner bases or heads.

Make sure that the heads (on some models) and caps are replaced in the correct locations.

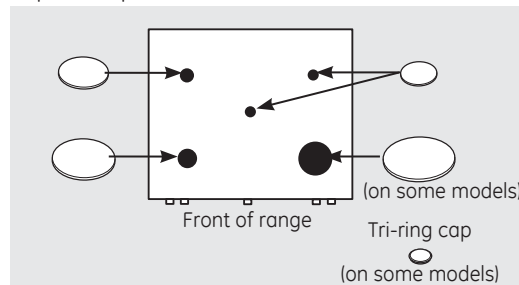

# Care and cleaning of the range.

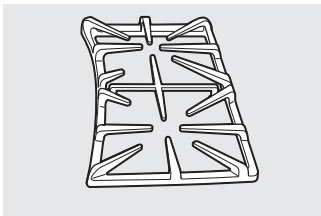

Appearance may vary.

The grates may be cleaned in a dishwasher.

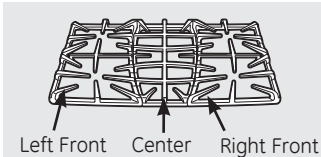

Left Front Center Right Front

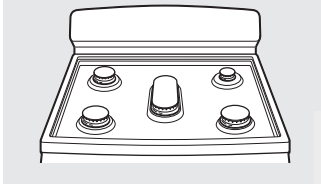

## Burner Grates

Your range has two or three professional-style double grates. These grates are position-specific. For maximum stability, these grates should only be used in their proper position; they cannot be interchanged left to right or front to back. For convenience, the undersides of the left and right grates are marked "LEFT FRONT" and "RIGHT FRONT." Make sure the front portion of both grates is in front. The middle grate has a bow in front. Make sure the bowed portion is toward the front of the range. In addition, the middle grate is supported by the left and right grates and must be installed LAST for stability.

### Cleaning

Lift out when cool. Grates should be washed regularly and, of course, after spills. Wash them in hot, soapy water and rinse with clean water. When replacing the grates, be sure they are positioned securely over the burners.

Replace the grates so that continuous arcs are formed with the center ribs of all three grates.

Do not operate a burner for an extended period of time without cookware on the grate. The finish on the grate may chip without cookware to absorb the heat.

To get rid of burned-on food, place the grates in a covered container. Add 1/4 cup ammonia and let them soak several hours or overnight. Wash, rinse well and dry.

Although they are durable, the grates will gradually lose their shine, regardless of the best care you can give them. This is due to their continual exposure to high temperatures. You will notice this sooner with lighter color grates.

**NOTE:** Do not clean the grates in a self-cleaning oven.

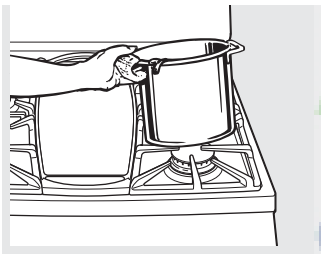

## Cooktop Surface

To avoid damaging the porcelain-enamel surface of the cooktop and to prevent it from becoming dull, clean up spills right away. Foods with a lot of acid (tomatoes, sauerkraut, fruit juices, etc.) or foods with high sugar content could cause a dull spot if allowed to set.

When the surface has cooled, wash and rinse. For other spills such as fat splatterings, wash with soap and water once the surface has cooled. Then rinse and polish with a dry cloth.

**NOTE:** For stainless steel cooktops, refer to the Stainless steel surfaces section.

## Oven Air Vents

Never block the vents (air openings) of the range. They provide the air inlet and outlet that are necessary for the range to operate properly with correct combustion.

Air openings are located at the rear of the cooktop, at the top and bottom of the oven door, and at the bottom of the range.

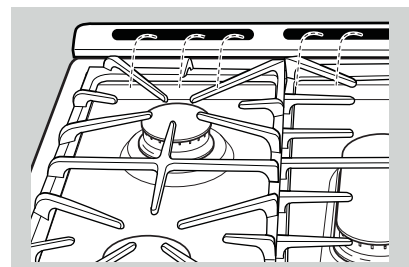

Vent appearance and location vary.

## Upper Control Panel

On models so equipped, lock out the touch pads before cleaning.

Clean up splatters with a damp cloth.

You may also use a glass cleaner.

Remove heavier soil with warm soapy water.

Do not use abrasives of any kind.

Unlock the touch pads after cleaning.



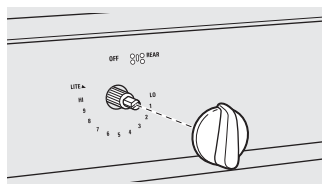

Surface burner knob

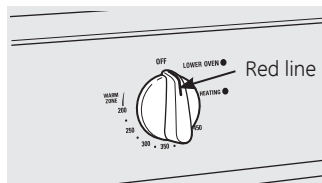

Red line

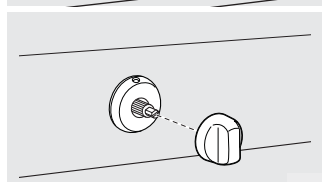

Lower oven knob (on some models)

## Lower Control Panel (Front Manifold Panel) and Knobs

It's a good idea to wipe the control panel after each use of the oven. Use a damp cloth to clean or rinse. For cleaning, use mild soap and water or a 50/50 solution of vinegar and water. For rinsing, use clean water. Polish dry with a soft cloth.

Do not use abrasive cleansers, strong liquid cleaners, plastic scouring pads or oven cleaners on the control panel—they will damage the finish.

Do not try to bend knobs by pulling them up or down or by hanging a towel or other such loads. This can damage the gas valve shaft.

The control knobs may be removed for easier cleaning.

Make sure the knobs are in the **OFF** positions and pull them straight off the stems for cleaning.

The knobs can be cleaned in a dishwasher or they may also be washed with soap and water. Make sure the insides of the knobs are dry before replacing.

Replace the knobs in the **OFF** position to ensure proper placement.

Metal parts can be cleaned with soap and water. Do not use steel wool, abrasives, ammonia, acids or commercial oven cleaners. Dry with a soft cloth.

**NOTE:** Knobs are not interchangeable. Be sure to reinstall the knobs to the original location.

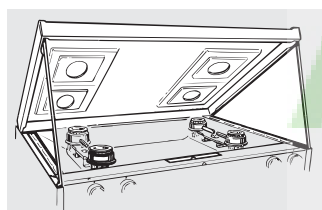

Some models have dual support rods that will hold the cooktop up while you clean underneath it.

## Lift-Up Cooktop (on models with standard twin burners)

Clean the area under the cooktop often. Built-up soil, especially grease, may catch on fire.

To make cleaning easier, the cooktop may be lifted up.

**NOTE:** Do not lift the cooktop on sealed burner models. Lifting the cooktop can lead to damage and improper operation of the range.

### To raise the cooktop:

- 1 Be sure the burners are turned off.
- 2 Remove the grates.
- 3 Grasp the two front burner wells and lift up.

Clean under the cooktop with hot, soapy water and a clean cloth. If you removed your surface burners while cleaning, make sure they are properly seated when replacing them.

After cleaning, lower the cooktop (be careful not to pinch your fingers).

# Care and cleaning of the range.

## Oven Bottom

The oven bottom has a porcelain-enamel finish. To make cleaning easier, protect the oven bottom from excessive spillovers by placing a cookie sheet on the rack below the rack you are cooking on. This is particularly important when baking a fruit pie or other foods with a high acid content. Hot fruit fillings or other foods that are highly acidic

(such as tomatoes, sauerkraut and sauces with vinegar or lemon juice) may cause pitting and damage to the porcelain-enamel surface and should be wiped up immediately.

To clean up spillovers, use soap and water, an abrasive cleaner or soap-filled scouring pad. Rinse well to remove any soap before self-cleaning.

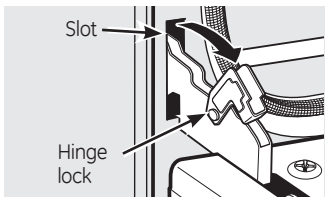

Pull hinge locks down to unlock.

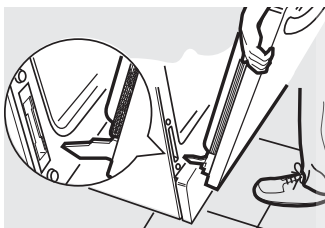

Removal position

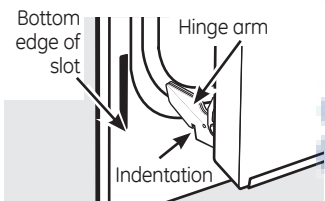

### Lift-Off Oven Door (on some models)

The door is very heavy. Be careful when removing and lifting the door.

Do not lift the door by the handle.

#### To remove the door:

- 1 Fully open the door.
- 2 Pull the hinge locks down toward the door frame, to the unlocked position. A tool, such as a small flat-blade screwdriver, may be required.
- 3 Firmly grasp both sides of the door at the top.
- 4 Close door to the door removal position, which is halfway between the broil stop position and fully closed.
- 5 Lift door up and out until the hinge arm is clear of the slot.

#### To replace the door:

- 1 Firmly grasp both sides of the door at the top.
- 2 With the door at the same angle as the removal position, seat the indentation of the hinge arm into the bottom edge of the hinge slot. The notch in the hinge arm must be fully seated into the bottom of the slot.
- 3 Fully open the door. If the door will not fully open, the indentation is not seated correctly in the bottom edge of the slot.
- 4 Push the hinge locks up against the front frame of the oven cavity to the locked position.
- 5 Close the oven door.

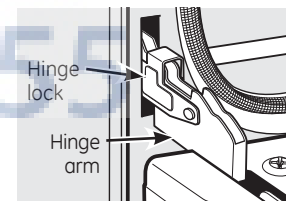

Push hinge locks up to lock.

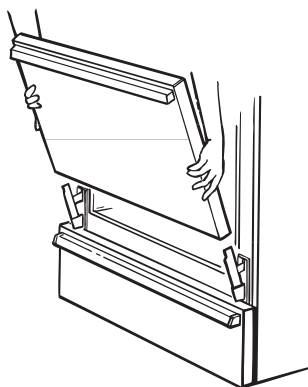

Lift the door straight up and off the hinges.

### Lift-Off Oven Door (on some models)

The oven door is removable, but it is heavy. You may need help removing and replacing the door.

#### To remove the door:

- 1 Open it a few inches to the special stop position that will hold the door open.
- 2 Grasp firmly on each side and lift the door straight up and off the hinges.

**NOTE:** Be careful not to place hands between the hinge and the oven door frame since the hinge could snap back and pinch

fingers.

#### To replace the door:

- 1 Make sure the hinges are in the special stop position. Position the slots in the bottom of the door squarely over the hinges.
- 2 Lower the door slowly and evenly over both hinges at the same time. If the hinges snap back against the oven frame, pull them back out.

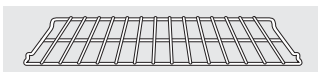

## Oven Racks

All oven racks may be cleaned by hand with an abrasive cleaner or steel wool. After cleaning, rinse the racks with clean water and dry with a clean cloth. Gray porcelain-coated oven racks may remain in the oven during the self-cleaning cycle without being damaged. The nickel-plated oven racks may remain in the oven during the self-cleaning cycle, but they will lose their luster

and become hard to slide. It will be necessary to grease all oven rack side edges with a light coating of vegetable oil after cleaning them by hand or in the oven. This will help maintain the ease of sliding the racks in and out of the oven.

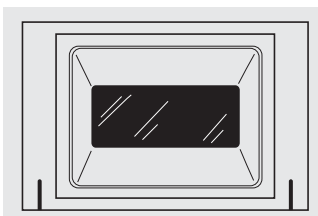

The gasket is designed with a gap at the bottom to allow for proper air circulation.

Do not rub or clean the door gasket—it has an extremely low resistance to abrasion.

If you notice the gasket becoming worn, frayed or damaged in any way or if it has become displaced on the door, you should have it replaced.

## Cleaning the Door

### To clean the inside of the door:

- Do not allow excess water to run into any holes or slots in the door.
- Wipe dishwashing detergent over any baked-on spatters on the glass. Use a single sided safety razor blade to clean it off. Then wipe over the glass with a soapy cloth to remove any residue and dry off.
- The area outside the gasket can be cleaned with a soap-filled plastic scouring pad.

### To clean the outside of the door:

- Use soap and water to thoroughly clean the top, sides and front of the oven door. Rinse well. You may also use a glass cleaner to clean the glass on the outside of the door.
- Spillage of marinades, fruit juices, tomato sauces and basting materials containing acids may cause discoloration and should be wiped up immediately. When the surface is cool, clean and rinse.
- Do not use oven cleaners, cleansing powders or harsh abrasives on the outside of the door.

## Stainless Steel Surfaces (on some models)

**Do not use a steel wool pad; it will scratch the surface.**

**IMPORTANT: APPLY A PROTECTIVE COAT OF CERAMA BRYTE® PART # WB02T10111 STAINLESS STEEL BRIGHTENER BEFORE USING.**

This will help you to maintain the brightness and appearance of your stainless steel range.

- In order to avoid any discolorations and/or grease stains, we recommend cleaning and removing any spills, spots and grease from the range after use.
- It is important to use a soft cloth or paper towel every time the range is cleaned to avoid any scratches.

Read carefully the instructions on the back of the Brightener for better results.

### Cleaning Instructions:

1. Remove grates.
2. Wash using warm, soapy water:
  - Wet soft cloth or paper towel (avoid using excessive water).
  - Wipe the surface in the direction of the grain (following the steel lines).
  - Rinse and wring out a soft cloth or paper towel and dry the range.

3. Apply a degreaser that does not contain sodium hydroxide or stainless steel cleaner (follow instructions).
4. Apply Cerama Bryte® Stainless Steel Brightener (follow instructions).
5. Repeat steps 2–4 as many times as needed.
6. Put grates back in place.

Follow these instructions for any stainless steel surface on your range.

### **DO NOT USE for cooktop or stainless steel parts cleaning:**

- Caustic lye (sodium hydroxide) or cleaners containing this chemical
- Hard or steel wool pads
- Abrasive materials or chemicals

To inquire about purchasing stainless steel appliance cleaner or polish, or to find the location of a dealer nearest you, please call our toll-free number:

**National Parts Center** 800.626.2002 (U.S.)  
800.661.1616 (Canada)

**GEAppliances.com (U.S.)**  
**www.GEAppliances.ca (Canada)**

## Care and cleaning of the range.

### **⚠ WARNING**

*Shock or Burn Hazard: Before replacing oven light bulb, disconnect the electrical power to the range at the main fuse or circuit breaker panel. Failure to do so may result in electric shock or burn.*

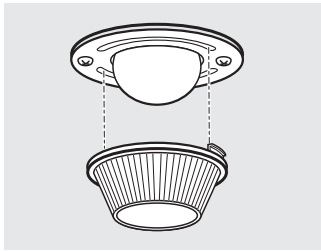

#### **Oven Light Replacement (on some models)**

Be sure to let the light cover and bulb cool completely.

##### **To remove the cover:**

- 1 Twist lens counterclockwise about a quarter turn to remove.  
*Do not remove any screws to remove the cover.*

- 2 Replace bulb with a 40-watt appliance bulb or two-prong halogen bulb, as appropriate.

##### **To replace the cover:**

- 1 Line up tabs of lens in front of tabs on housing and rotate clockwise to engage.

#### **Oven Light Replacement (on some models)**

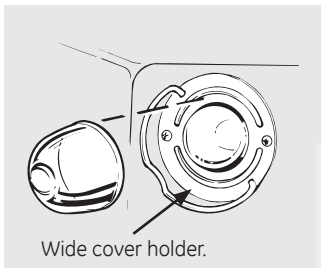

### **⚠ CAUTION**

*Before replacing your oven light bulb, disconnect the electrical power to the range at the main fuse or circuit breaker panel. Be sure to let the light cover and bulb cool completely.*

The oven light bulb is covered with a removable glass cover that is held in place with a bail-shaped wire. Remove the oven door, if desired, to reach cover easily.

##### **To remove:**

- 1 Hold a hand under the cover so it doesn't fall when released. With fingers of the same hand, firmly push back the wire cover holder. Lift off the cover.

**Do not remove any screws to remove the cover.**

- 2 Do not touch hot bulb with a wet cloth. Replace bulb with a 40-watt household appliance bulb.

##### **To replace cover:**

- 1 Place it into the groove of the light receptacle. Pull the wire forward to the center of the cover until it snaps into place. When in place, the wire holds the cover firmly. Be certain the wire is in the depression in the center of the cover.
- 2 Connect electrical power to the range.

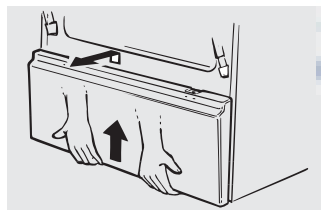

#### **Removable Kick Panel (on some models)**

The kick panel may be removed for cleaning under the range.

##### **To remove:**

Lift up the bottom of the panel slightly to disengage the panel from the tabs at the base of the range. Pull the bottom of the panel forward until the spring clips are released at the top of the panel.

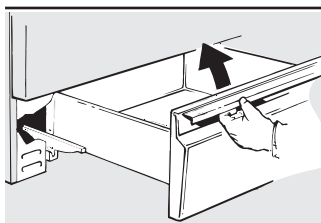
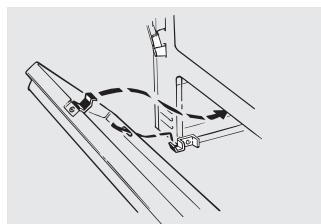

The storage drawer may be removed for cleaning under the range.

#### **Removable Storage Drawer (on some models)**

The storage drawer is a good place to store cookware and bakeware. Do not store plastics and flammable material in the drawer.

The storage drawer may be removed for cleaning under the range. Clean the storage drawer with a damp cloth or sponge. Never use harsh abrasives or scouring pads.

##### **To remove storage drawer:**

- 1 Pull drawer straight out until it stops.
- 2 Tilt the front of the drawer up and free of the range.

##### **To replace storage drawer:**

- 1 Set the stops on the back of the drawer over the stops in the range.
- 2 Slide drawer evenly and straight back, so that the rails in the range are engaged.



**CAUTION** During the steam clean cycle, the oven bottom becomes hot enough to cause burns. Wait until the cycle is over (30 minutes) before wiping the inside surfaces of the oven. Failure to do so may result in burns.

The Steam Clean cycle makes it easier to clean light soiling from the porcelain oven interior and door glass.

The range should be at room temperature before beginning the Steam Clean cycle. If the oven is too hot, "Hot" will appear on the display and the cycle will not activate until the oven cools down.

The Steam Clean cycle performs best on new spills or soils. Burned-on food is more difficult to remove.

### To Begin Steam Clean Cycle:

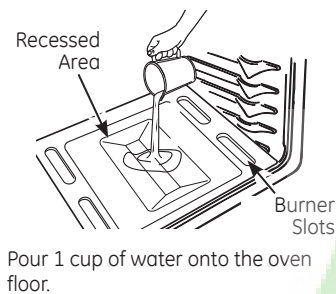

1 Remove racks and accessories from the oven cavity. Do not place cookware or other items in the oven during the Steam Clean cycle.

2 Pour 1 cup (8 oz.) room-temperature water onto the recessed area of the oven bottom. Do not add cleaning solutions or chemicals of any kind to the water. Do not pour water down the burner slots on oven bottom.

3 Close the door.

4 Press the **Steam Clean** pad; then press **Start/On**.

5 A 30-minute cycle will begin to count down on the display.

6 When the Steam Clean cycle is complete, the oven control will beep and the **Steam Clean** light will blink. Press the **Clear/Off** pad and **open the door**.

7 The oven bottom and remaining water will still be very warm at the end of the cycle. This is normal.

8 Remove soils using a scrub brush or nylon scouring pad. A soap-filled steel wool pad may be used only on the porcelain oven interior. **The use of abrasive pads will scratch the door glass.** Do not wipe soil or water onto the door gasket.

9 Remove any remaining water with a dry cloth or sponge.

10 Leave the door open to air dry.

### IMPORTANT NOTES:

- If a steam clean cycle is initiated without water, press the **Clear/Off** pad to end the cycle. Wait for the range to cool to room temperature before pouring water into the recessed area and initiating another steam cycle.
- Do not open the door during the Steam Clean cycle. An error beep will sound upon opening the door.
- Press **Clear/Off** pad at any time to end the cycle.
- If mineral deposits remain in the oven bottom after cleaning, use a cloth or sponge soaked in vinegar to remove them.
- Some water may drip from the bottom of the oven door. If this happens, wipe it up at the end of the cycle.
- The door gasket may be wet when the Steam Clean cycle finishes. This is normal. Do not clean the gasket.
- If soil still remains after cleaning the oven, see the *Care and Cleaning of the Range* section of the Owner's Manual for additional options.



AllMadison  
 Your Appliance Authority  
 800-570-3333

# Installation Instructions

# Range

If you have questions, call 1.800.GE.CARES or visit our Website at: [GEAppliances.com](http://GEAppliances.com)

## In the Commonwealth of Massachusetts

- This product must be installed by a licensed plumber or gas fitter.
- When using ball type gas shut-off valves, they shall be the T-handle type.
- A flexible gas connector, when used, must not exceed 3 feet.

## BEFORE YOU BEGIN

Read these instructions completely and carefully.

Installation of this range must conform with local codes, or in the absence of local codes, with the National Fuel Gas Code, ANSI Z223.1/NFPA.54, latest edition. In Canada, installation must conform with the current Natural Gas Installation Code, CAN/CGA-B149.1 or the current Propane Installation Code, CAN/CGA-B149.2, and with local codes where applicable. This range has been design-certified by CSA International according to ANSI Z21.1, latest edition and Canadian Gas Association according to CAN/CGA-1.1 latest edition.

As with any appliance using gas and generating heat, there are certain safety precautions you should follow. You will find these precautions in the *Important Safety Information* section in the front of this manual. Read them carefully.

- **IMPORTANT** – Save these instructions for local electrical inspector's use.
- **IMPORTANT** – Observe all governing codes and ordinances.
- **Note to Installer** – Leave these instructions with the appliance after installation is completed.
- **Note to Consumer** – Keep this Owner's Manual and Installation Instructions for future reference.
- **Note** – This appliance must be properly grounded.
- **Service** – The electrical diagram is in an envelope attached to the back of the range.
- Proper installation is the responsibility of the installer.
- Product failure due to improper installation is not covered under the Warranty.

### Mobile Home - Additional Installation Requirements

The installation of this range must conform to the Manufactured Home Construction and Safety Standard, Title 24 CFR, Part 3280 (formerly the Federal Standard for Mobile Home Construction, use the Standard for Manufactured Home Installations, ANSI A225, 1/NFPA 501A or with local codes.

### Mobile home installations require:

- When this range is installed in a mobile home, it must be secured to the floor during transit. Any method of securing the range is adequate as long as it conforms to the standards listed above.

## FOR YOUR SAFETY

Do not store or use combustible materials, gasoline or other flammable vapors and liquids in the vicinity of this or any other appliance.

### If you smell gas:

- 1 Open windows.
- 2 Don't touch electrical switches.
- 3 Extinguish any open flame.
- 4 Immediately call your gas supplier.

## TOOLS YOU WILL NEED



Phillips screwdriver



Flat-blade screwdriver



Pencil and ruler

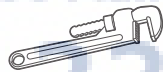

Pipe wrenches (2)  
(one for backup)



Open-end or  
adjustable wrench



Level



Drill, awl or nail

## MATERIALS YOU MAY NEED

- Gas line shut-off valve
- Pipe joint sealant or UL-approved pipe thread tape with Teflon\* that resists action of natural and LP gases
- Flexible metal appliance connector (1/2" I.D.)  
A 5-foot length is recommended for ease of installation but other lengths are acceptable. Never use an old connector when installing a new range.
- Flare union adapter for connection to gas supply line (3/4" or 1/2" NPT x 1/2" I.D.)
- Flare union adapter for connection to pressure regulator on range (1/2" NPT x 1/2" I.D.)
- Liquid leak detector or soapy water.
- Lag bolt or 1/2" O.D. sleeve anchor (for concrete floors only).

\*Teflon: Registered trademark of DuPont

# Installation Instructions

## **WARNING**

### INSTALLATION SAFETY INSTRUCTIONS

Read these instructions completely and carefully. Failure to follow these instructions can result in electrical shock, fire, serious injury, or death.

- Improper installation, adjustment, alteration, service or maintenance can cause injury or property damage. Refer to this manual. For assistance or additional information, consult a qualified installer, service agency, manufacturer (dealer) or the gas supplier.
- Never reuse old flexible connectors. The use of old flexible connectors can cause gas leaks and personal injury. Always use **NEW** flexible connectors when installing a gas appliance.
- Leak testing of the appliance shall be conducted according to the manufacturer instructions.
- Remove all packing material and literature from oven before connecting gas and electrical supply to range.
- Do not attempt to operate the oven of this range during a power failure (Electric Ignition models only).
- Have your range installed by a qualified installer.
- Your range must be electrically grounded in accordance with local codes or, in the absence of local codes, in accordance with the National Electrical Code (ANSI/NFPA 70, latest edition). In Canada, electrical grounding must be in accordance with the current CSA C22.1 Canadian Electrical Code Part 1 and/or local codes. See *Electrical Connections* in this section.
- Before installing your range on linoleum or any other synthetic floor covering, make sure the floor covering can withstand 180°F without shrinking, warping or discoloring. Do not install the range over carpeting unless a sheet of 1/4" thick plywood or similar insulator is placed between the range and carpeting.
- Make sure the wall coverings around the range can withstand heat generated by the range up to 200°F.

- Avoid placing cabinets above the range. To reduce the hazard caused by reaching over the open flames of operating burners, install a ventilation hood over the range that projects forward at least 5" beyond the front of the cabinets.

- The ventilating hood must be constructed of sheet metal not less than 0.0122" thick. Install above the cooktop with a clearance of not less than 1/4" between the hood and the underside of the combustible material or metal cabinet. The hood must be at least as wide as the appliance and centered over the appliance. Clearance between the cooking surface and the ventilation hood surface **MUST NEVER BE LESS THAN 24"**.

**EXCEPTION:** Installation of a listed microwave oven or cooking appliance over the cooktop shall conform to the installation instructions packed with that appliance.

- If cabinets are placed above the range, allow a minimum clearance of 30" between the cooking surface and the bottom of unprotected cabinets.
- If a 30" clearance between cooking surface and overhead combustible material or metal cabinets cannot be maintained, protect the underside of the cabinets above the cooktop with not less than 1/4" insulating millboard covered with sheet metal not less than 0.0122" thick. Clearance between the cooking surface and protected cabinets **MUST NEVER BE LESS THAN 24"**.
- The vertical distance from the plane of the cooking surface to the bottom of adjacent overhead cabinets extending closer than 1" to the plane of the range sides must not be less than 18". (See the Dimensions and Clearances illustration in this section.)

** CAUTION** - Only the GE Café branded series of Advantium® or microwave over-the-range ovens are designed to be installed above the GE Café range. Surfaces above a gas range can become hot. Installation of any other over-the-range oven above a GE Café range may result in surface temperatures that can cause burns.

# Installation Instructions

## DIMENSIONS AND CLEARANCES

Provide adequate clearances between the range and adjacent combustible surfaces. These dimensions must be met for safe use of your range. The location of the electrical outlet and pipe opening (see Gas Pipe and Electric Outlet Locations) may be adjusted to meet specific requirements.

The range may be placed with 0" clearance (flush) at the back wall.

\*Models PGB900, PGB910, PGB915, PGB930, PGB935, JGB295, JGB296, JGB600, JGB605, JGB810 and JGB840 require only 3" minimum clearance to left wall.

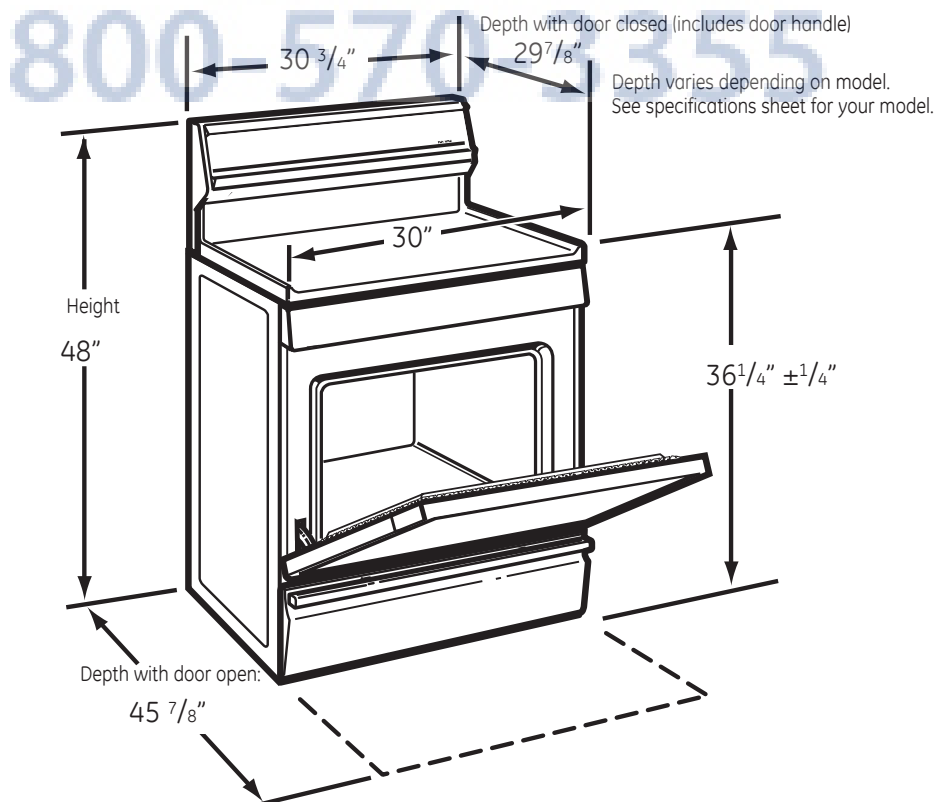
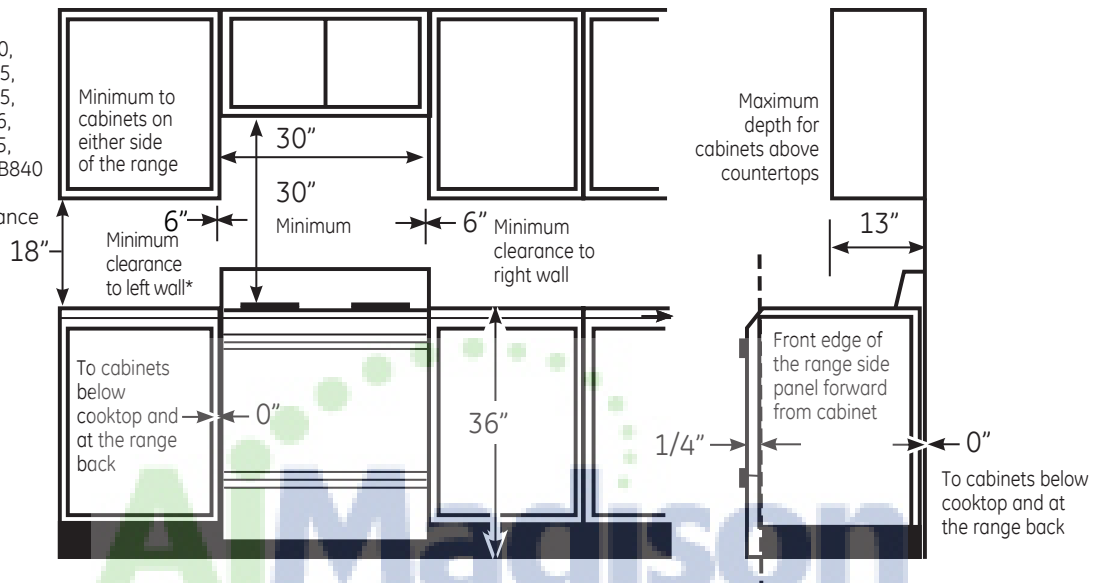

# Installation Instructions

## DIMENSIONS AND CLEARANCES (Models CGS985 only)

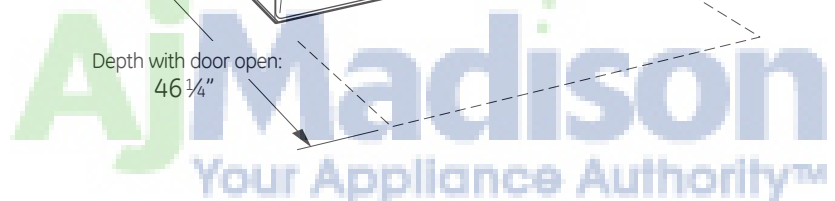
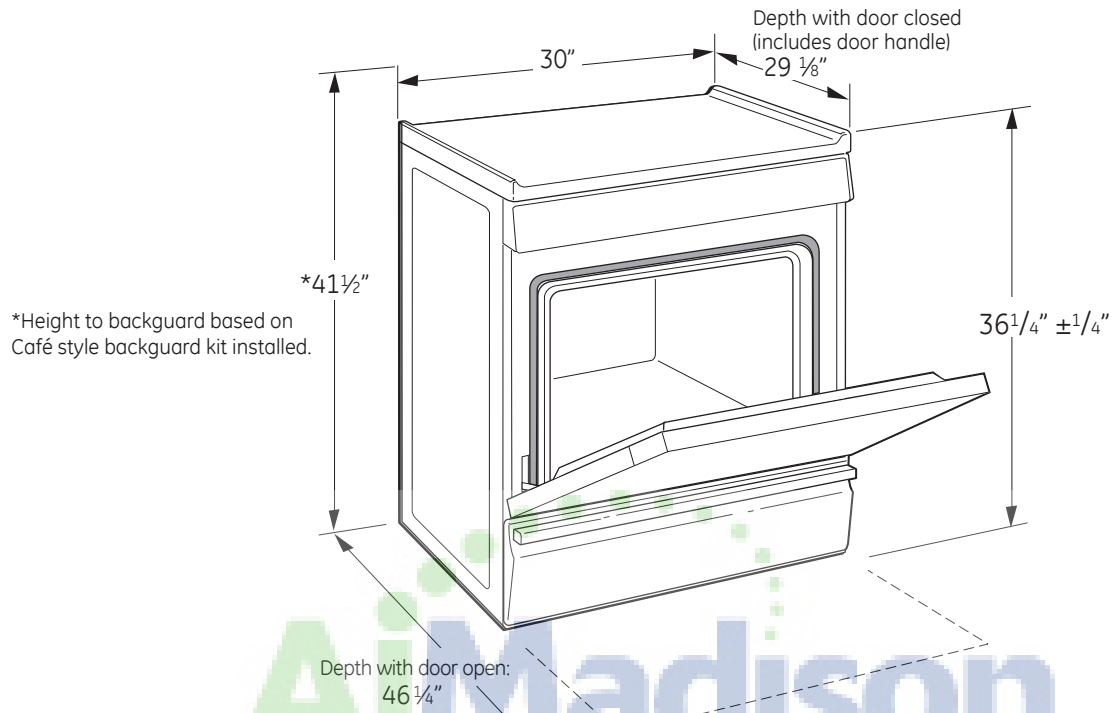

800-570-3355

# Installation Instructions

## LOCATION

Do not locate the range where it may be subject to strong drafts. Any openings in the floor or wall behind the range should be sealed. Make sure the openings around the base of the range that supply fresh air for combustion and ventilation are not obstructed by carpeting or woodwork.

Your range, like many other household items, is heavy and can settle into soft floor coverings such as cushioned vinyl or carpeting. Use care when moving the range on this type of flooring. It is recommended that the following simple and inexpensive instructions be followed to protect your floor.

The range should be installed on a sheet of plywood (or similar material). When the floor covering ends at the front of the range, the area that the range will rest on should be built up with plywood to the same level or higher than the floor covering.

This will allow the range to be moved for cleaning or servicing. Also, make sure your floor covering will withstand 180°F. (See the Installation Safety Instructions section.)

Make sure the wall coverings around your range can withstand the heat generated (up to 200°F) by the range. (See the *Installation Safety Instructions* section.)

## IMPORTANT!

Remove all tape and packaging. Make sure the burners are properly seated and level.

Take the accessory pack out of the oven and/or drawer.

Check to be sure that no range parts have come loose during shipping.

## CONVERTING TO LP GAS (or converting back to natural gas from LP)

This range leaves the factory set for use with natural gas. If you want to convert to LP gas, the conversion must be performed by a qualified LP gas installer.

The conversion instructions and LP orifices can be found attached to the range next to the pressure regulator.

Keep these instructions and the orifices in case you want to convert back to natural gas.

## 1 PROVIDE ADEQUATE GAS SUPPLY

Your range is designed to operate at a pressure of 5" of water column on natural gas or, if designed for LP gas (propane or butane), 10" of water column.

Make sure you are supplying your range with the type of gas for which it is designed.

This range is convertible for use on natural or propane gas. If you decide to use this range on LP gas, conversion must be made by a qualified LP installer before attempting to operate the range on that gas.

For proper operation, the pressure of natural gas supplied to the regulator must be between 5" and 13" of water column.

For LP gas, the pressure supplied must be between 10" and 13" of water column.

When checking for proper operation of the regulator, the inlet pressure must be at least 1" greater than the operating (manifold) pressure as given above.

The pressure regulator located at the inlet of the range manifold must remain in the supply line regardless of whether natural or LP gas is being used.

A flexible metal appliance connector used to connect the range to the gas supply line should have an I.D. of 1/2" and be 5 feet in length for ease of installation. In Canada, flexible connectors must be single wall metal connectors no longer than 6 feet in length.

# Installation Instructions

## 2 CONNECT THE RANGE TO GAS

Shut off the main gas supply valve before disconnecting the old range and leave it off until the new hook-up has been completed. Don't forget to relight the pilot on other gas appliances when you turn the gas back on.

Because hard piping restricts movement of the range, the use of a CSA International-certified flexible metal appliance connector is recommended unless local codes require a hard-piped connection.

Never use an old connector when installing a new range. If the hard piping method is used, you must carefully align the pipe; the range cannot be moved after the connection is made.

To prevent gas leaks, put pipe joint compound on, or wrap pipe thread tape with Teflon\* around, all male (external) pipe threads.

A. Install a manual gas line shut-off valve in the gas line in an easily accessed location outside of the range. Make sure everyone operating the range knows where and how to shut off the gas supply to the range.

B. Install male 1/2" flare union adapter to the 1/2" NPT internal thread at inlet of regulator. Use a backup wrench on the regulator fitting to avoid damage.

When installing the range from the front, remove the 90° elbow for easier installation.

C. Install male 1/2" or 3/4" flare union adapter to the NPT internal thread of the manual shut-off valve, taking care to back-up the shut-off valve to keep it from turning.

D. Connect flexible metal appliance connector to the adapter on the range. Position range to permit connection at the shut-off valve.

E. When all connections have been made, make sure all range controls are in the off position and turn on the main gas supply valve. Use a liquid leak detector at all joints and connections to check for leaks in the system.

**⚠ WARNING** Fire hazard: Do not use a flame to check for gas leaks.

When using test pressures greater than 1/2 psig to pressure test the gas supply system of the residence, disconnect the range and individual shut-off valve from the gas supply piping. When using test pressures of 1/2 psig or less to test the gas supply system, simply isolate the range from the gas supply system by closing the individual shut-off valve.

\*Teflon: Registered trademark of DuPont

## GAS PIPE AND ELECTRICAL OUTLET LOCATIONS

Recommended area for 120V outlet on rear wall and area for through-the-wall connection of pipe stub and shut-off valve.

Recommended area for through-the-floor connection of pipe stub and shut-off valve.

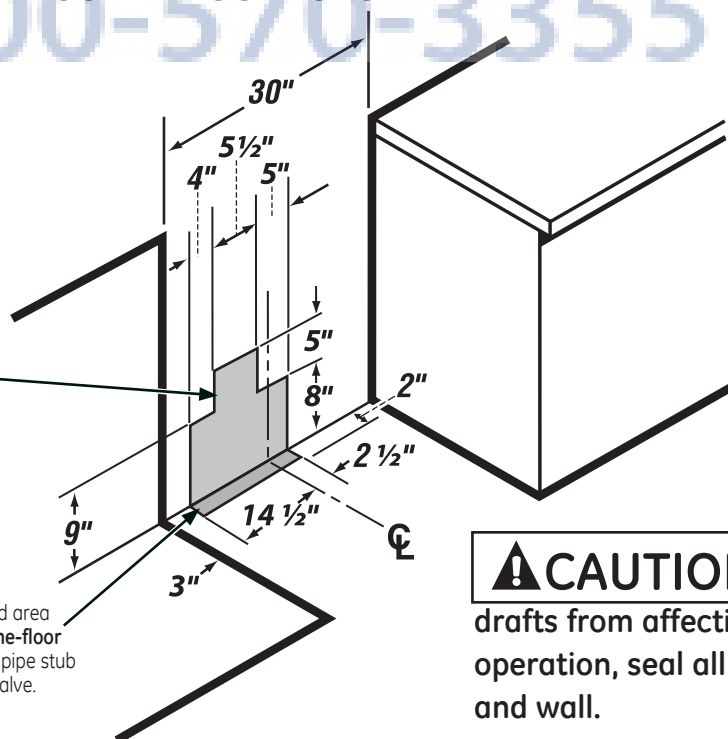

**⚠ CAUTION** To prevent drafts from affecting burner operation, seal all openings in floor and wall.

# Installation Instructions

## FLEXIBLE CONNECTOR HOOKUP

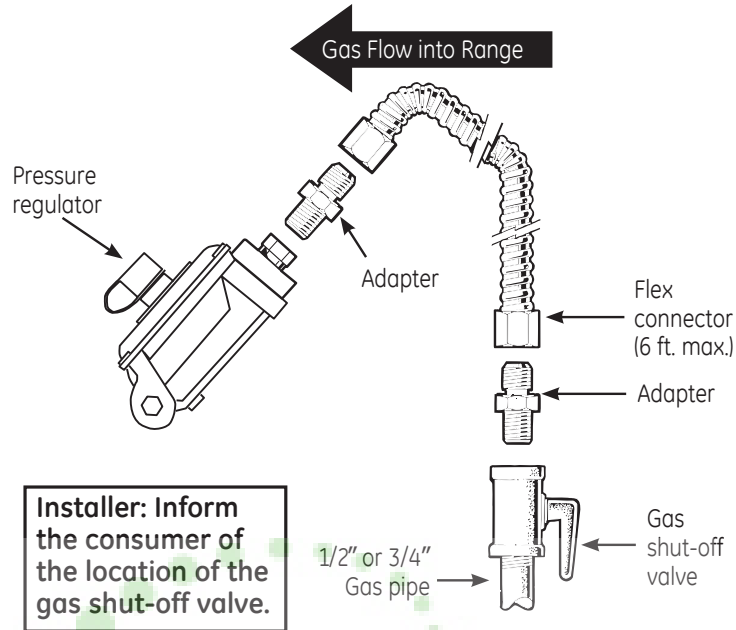

## RIGID PIPE HOOKUP OPTIONS

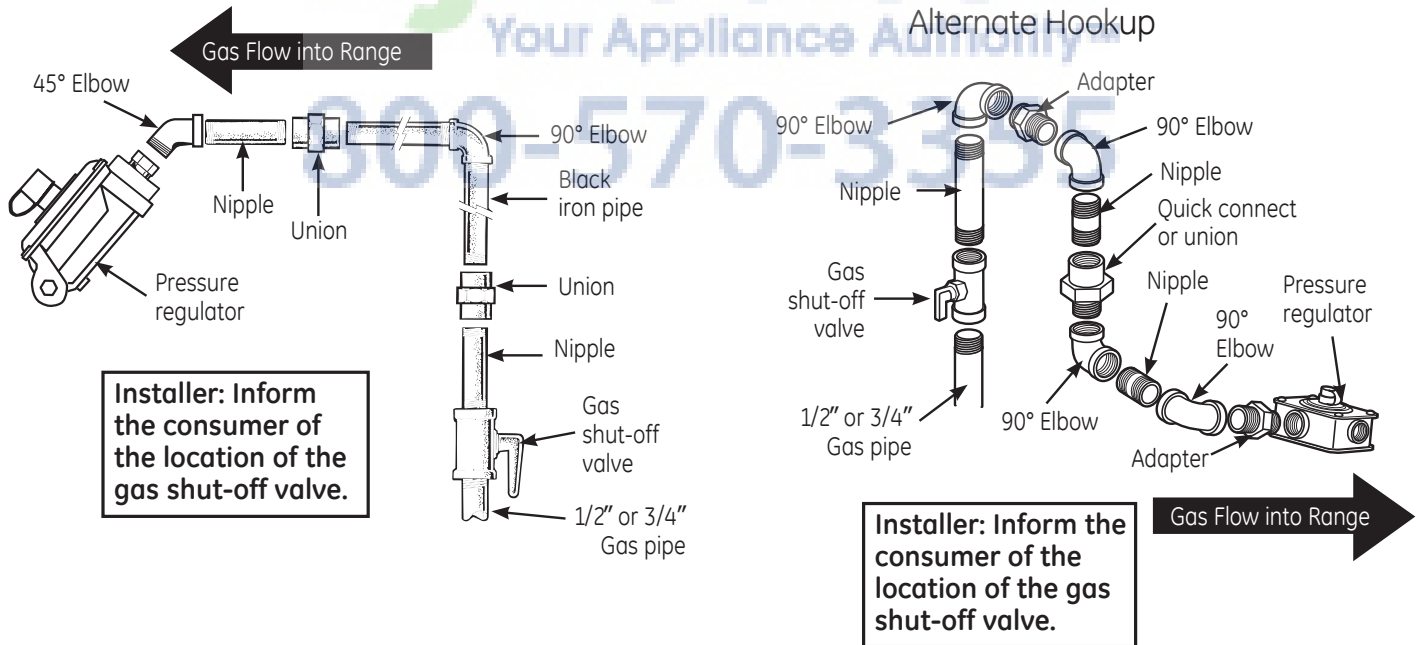



# Installation Instructions

## 3 ELECTRICAL CONNECTIONS

### Electrical Requirements

120-volt, 60 Hertz, properly grounded dedicated circuit protected by a 15-amp or 20-amp circuit breaker or time delay fuse.

**Note:** Use of automatic, wireless, or wired external switches that shut off power to the appliance are not recommended for this product.

### Grounding

**⚠️ WARNING** Shock Hazard: This appliance must be properly grounded. Failure to do so can result in electric shock.

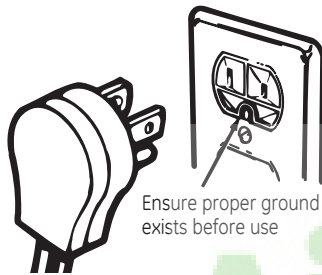

The power cord of this appliance is equipped with a three-prong (grounding) plug which mates with a standard three-prong grounding wall receptacle to minimize the possibility of electric shock hazard from this appliance.

The customer should have the wall receptacle and circuit checked by a qualified electrician to make sure the receptacle is properly grounded.

Where a standard two-prong wall receptacle is encountered, it is the personal responsibility and obligation of the customer to have it replaced with a properly grounded three-prong wall receptacle.

**DO NOT, UNDER ANY CIRCUMSTANCES, CUT OR REMOVE THE THIRD (GROUND) PRONG FROM THE POWER CORD. DO NOT USE AN ADAPTER. DO NOT USE AN EXTENSION CORD.**

**A word about GFCI's – GFCI's are not required or recommended for gas range receptacles.**

Ground Fault Circuit Interrupters (GFCI's) are devices that sense leakage of current in a circuit and automatically switch off power when a threshold leakage level is detected. These devices must be manually reset by the consumer. The National Electrical Code requires the use of GFCI's in kitchen receptacles installed to serve countertop surfaces. Performance of the range will not be affected if operated on a GFCI-protected circuit but occasional nuisance tripping of the GFCI breaker is possible.

## 4 SEAL THE OPENINGS

Seal any openings in the wall behind the range and in the floor under the range when hookups are completed.

## 5 ASSEMBLE SURFACE BURNERS

### A Burner Heads (on some models)

Place burner heads over the electrodes on the cooktop, in the correct locations according to their size.

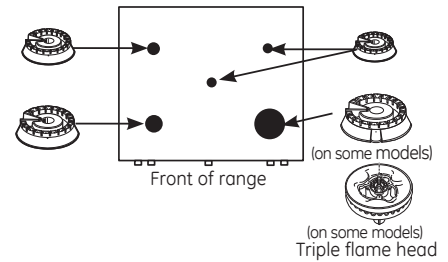

Make sure the slot in the burner head is positioned over the electrode.

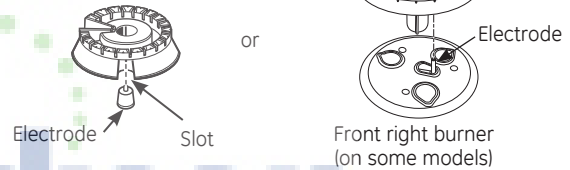

### B Oval (Center) Burner Head/Cap Assembly

Place the oval (center) head/cap assembly over the electrode on the cooktop.

Oval head and cap assembly

Make sure the slot in the burner head is positioned over the electrode.

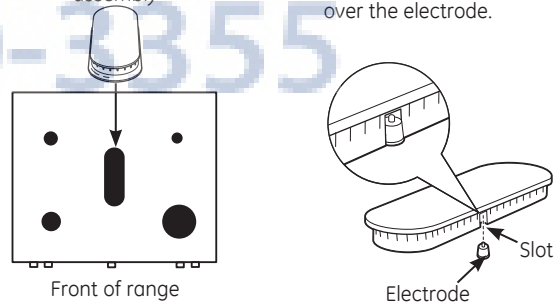

### C Caps

Place the matching size caps onto the burner bases or heads.

Make sure that the heads (on some models) and caps are replaced in the correct locations.

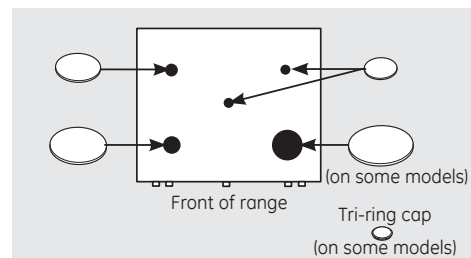

# Installation Instructions

## 5 ASSEMBLE SURFACE BURNERS (CONT.)

### D Grates

Place the left, right and center grates on the cooktop. These grates are position specific. The undersides of the left and right grates are marked "LEFT FRONT" and "RIGHT FRONT." On some models the underside of the grates are marked "Outside". Place the middle grate with its bowed front toward the front of the range.

**CAUTION** Do not operate the burner without all burner parts in place.

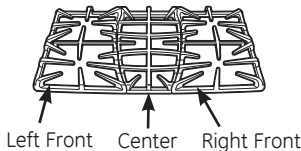

## 6 CHECK IGNITION OF SURFACE BURNERS

Operation of all cooktop and oven burners should be checked after the range and gas supply lines have been carefully checked for leaks.

### Electric Ignition Models

Select a top burner knob and simultaneously push in and turn to LITE position. You will hear a **clicking** sound indicating proper operation of the spark module. Once the air has been purged from the supply lines, burners should light within 4 seconds. After burner lights, rotate knob out of the LITE position. Try each burner in succession until all burners have been checked.

### Quality of Flames

The combustion quality of burner flames needs to be determined visually.



(A) Yellow flames—  
Call for service



(B) Yellow tips  
on outer cones—  
Normal for LP gas



(C) Soft blue  
flames—Normal  
for natural gas

If burner flames look like (A), call for service. Normal burner flames should look like (B) or (C), depending on the type of gas you use.

With LP gas, some yellow tipping on outer cones is normal.

## 7 CHECK IGNITION OF OVEN BURNER

The oven is designed to operate quietly and automatically. To operate the oven, press the **Bake** pad and then press the number pads until **350°** appears in the display. Touch the **Start** pad. After 30–90 seconds, the oven burner will ignite and burn until the set temperature is reached. The oven burner will continue to cycle on and off as necessary to maintain the oven at the temperature indicated by the display.

To check ignition of the broil burner, touch the **Broil Hi/Lo** pad and then the **Start** pad. After 30–90 seconds, the broil burner will ignite.

**Electric ignition models** require electrical power to operate. In case of a power outage, the oven burners on these models cannot be lit manually with a match. Gas will not flow unless the glow bar is hot.

If the oven is in use when a power outage occurs, the burner will shut off and cannot be re-lit until power is restored.

# Installation Instructions

## 8 ADJUST BROIL AND OVEN BURNER AIR ADJUSTMENT SHUTTER IF NECESSARY

Air adjustment shutters for the top and bottom burners regulate the flow of air to the flames.

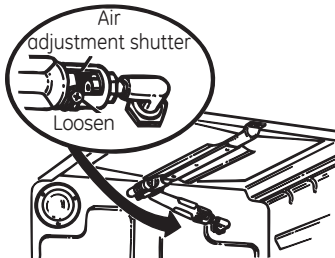

The air adjustment shutter for the top (broil) burner is in the center of the rear wall of the oven.

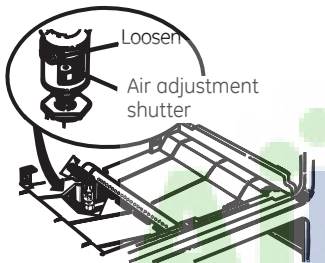

The shutter for the bottom (oven) burner is near the back wall behind the warming drawer. Remove the drawer. See the *Care and cleaning of the range* section.

To adjust the flow of air to either burner, loosen the Phillips head screw and rotate the shutter toward open or closed position as needed.

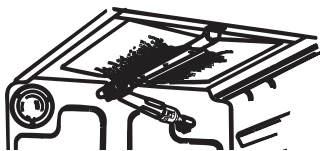

The flames for the top (broil) burner should be steady with approximately 1" blue cones and should not extend out over the edges of the burner baffle.

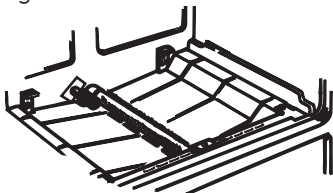

To determine if the bottom burner flames are burning properly, remove the oven bottom. Flames should have approximately 1" blue cones and, if range is supplied with natural gas, should burn with no yellow tipping. (With most LP gas, small yellow tips at the end of outer cones are normal.) Flames should not lift off burner ports. If lifting is observed, gradually reduce air shutter opening until flames are stabilized.

## 8 ADJUST BROIL AND OVEN BURNER AIR ADJUSTMENT SHUTTER IF NECESSARY (CONT.)

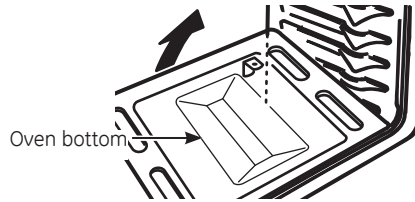

To remove the oven bottom:

- Remove the screws holding down rear of the oven bottom.
- Grasp the oven bottom at finger slots on each side.
- Lift the rear of the oven bottom enough to clear the lip of the range frame, push it back, and then pull it up and out.

## 9 LEVELING THE RANGE

- Install the oven shelves in the oven and position the range where it will be installed with front access to front leveling legs and rear access to rear leveling legs. All legs must be leveled *BEFORE* the product is installed.

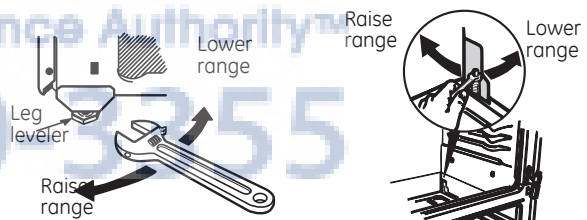

(on some models)

(on some models)

- Check for levelness by placing a spirit level or a cup, partially filled with water, on one of the oven shelves. If using a spirit level, take two readings—with the level placed diagonally first in one direction and then the other.
- Remove the drawer (on some models). See the *Care and cleaning of the range* section. The front leveling legs can be adjusted from the bottom and the rear legs can be adjusted from the top (on some models) or the bottom.
- Use an open-end or adjustable wrench to adjust the leveling legs until the range is level.

### **⚠ WARNING**

Never completely remove the leveling leg as the range will not be secured to the anti-tip device properly.

- After leveling the unit, slide it into final position and verify levelness.
- After the range is level, slide the range away from the wall so that the Anti-Tip device can be installed.

# Installation Instructions

## 10 INSTALLING THE ANTI-TIP DEVICE

### ⚠ WARNING

### ANTI-TIP DEVICE



- All ranges can tip.
- BURNS or other SERIOUS INJURIES can result.
- INSTALL and CHECK the anti-tip bracket following the instructions supplied with the bracket.



To reduce the risk of tipping the range, the range must be secured by a properly installed anti-tip bracket. Follow the instructions packaged with the bracket.

To check if the bracket is installed and engaged properly, look underneath the range to see that the rear leveling leg is engaged in the bracket. On some models, the storage drawer or kick panel can be removed for easy inspection. If visual inspection is not possible, slide the range forward, confirm the anti-tip bracket is securely attached to the floor or wall, and slide the range back so the rear leveling leg is under the anti-tip bracket.

If the range is pulled from the wall for any reason, always repeat this procedure to verify the range is properly secured by the anti-tip bracket.

If your range has no anti-tip bracket, call 1.800.626.8774 to receive one at no cost.

## WHEN ALL HOOKUPS ARE COMPLETED

Make sure all controls are left in the off position.  
Make sure the flow of combustion and ventilation air to the range is unobstructed.

# Before you call for service...



**Troubleshooting Tips**  
 Save time and money! Review the charts on the following pages first and you may not need to call for service.

Problem	Possible Causes	What To Do
<b>Top burners do not light or do not burn evenly.</b> <i>(The front right burner is designed to have slightly smaller flames between the 6 and 9 o'clock positions. This is normal.)</i>	<b>Plug on range is not completely inserted in the electrical outlet.</b>	<ul style="list-style-type: none"> <li>Make sure electrical plug is plugged into a live, properly grounded outlet.</li> </ul>
	<b>Burner slits on the side of the burner may be clogged.</b>	<ul style="list-style-type: none"> <li>Remove the burners and clean them. Check the electrode area for burned-on food or grease. See the <i>Care and cleaning of the range</i> section.</li> </ul>
	<b>Improper burner assembly.</b>	<ul style="list-style-type: none"> <li>Make sure the burner parts are installed correctly. See the <i>Care and cleaning of the range</i> section.</li> </ul>
<b>Burner flames very large or yellow</b>	<b>Improper air to gas ratio.</b>	<ul style="list-style-type: none"> <li>If range is connected to LP gas, contact the person who installed your range or made the conversion.</li> </ul>
<b>Surface burners light but oven does not</b>	<b>The oven gas shut-off valve may have accidentally been moved during cleaning or moving.</b>	<ul style="list-style-type: none"> <li>To check the oven gas shut-off valve, remove the drawer (see the <i>Care and cleaning of the range</i> section). For lower oven drawer models, remove the rear access panel by unscrewing the thumb screws in the upper left and right corners. Look for the gas shut-off lever at the back of the range.</li> </ul>
<b>Control signals after entering cooking time or start time</b>	<b>You forgot to enter a bake temperature or cleaning time.</b>	<ul style="list-style-type: none"> <li>Touch the <b>Bake</b> pad and desired temperature or the <b>Self Clean</b> pad and desired clean time.</li> </ul>
<b>Food does not bake or roast properly in the upper oven</b>	<b>Oven controls improperly set.</b>	<ul style="list-style-type: none"> <li>See the <i>Using the upper oven</i> section.</li> </ul>
	<b>Shelf position is incorrect.</b>	<ul style="list-style-type: none"> <li>See the <i>Using the upper oven</i> section.</li> </ul>
	<b>Incorrect cookware or cookware of improper size being used.</b>	<ul style="list-style-type: none"> <li>See the <i>Using the upper oven</i> section.</li> </ul>
	<b>Oven thermostat needs adjustment.</b>	<ul style="list-style-type: none"> <li>See the <i>Adjust the upper oven thermostat—Do it yourself!</i> section.</li> </ul>
	<b>Clock not set correctly.</b>	<ul style="list-style-type: none"> <li>See the <i>Using the clock and timer</i> section.</li> </ul>
	<b>Aluminum foil used improperly in the oven.</b>	<ul style="list-style-type: none"> <li>See the <i>Care and cleaning of the range</i> section.</li> </ul>
	<b>Oven bottom not securely seated in position.</b>	<ul style="list-style-type: none"> <li>See the <i>Installation of the range</i> section.</li> </ul>
<b>Burners do not light</b>	<b>Plug on range is not completely inserted in the electrical outlet.</b>	<ul style="list-style-type: none"> <li>Make sure electrical plug is plugged into a live, properly grounded outlet.</li> </ul>
	<b>Gas supply not connected or turned on.</b>	<ul style="list-style-type: none"> <li>See the Installation Instructions that came with your range.</li> </ul>
	<b>Bridge burner won't light</b>	<ul style="list-style-type: none"> <li>See <i>How to Light Bridge Burner for Model PGB980</i> section.</li> </ul>

## Before you call for service...



### Troubleshooting Tips

Problem	Possible Causes	What To Do
Burners do not light (cont.)	A fuse in your home may be blown or the circuit breaker tripped.	<ul style="list-style-type: none"> <li>• Replace the fuse or reset the circuit breaker.</li> </ul>
	Burner parts not replaced correctly.	<ul style="list-style-type: none"> <li>• See the <i>Care and cleaning of the range</i> section.</li> </ul>
Food does not broil properly in the upper oven	Oven controls improperly set.	<ul style="list-style-type: none"> <li>• Make sure you touch the <b>Broil Hi/Lo</b> pad.</li> </ul>
	Oven door not closed.	<ul style="list-style-type: none"> <li>• See the <i>Using the upper oven</i> section.</li> </ul>
	Improper shelf position being used.	<ul style="list-style-type: none"> <li>• See the <i>Broiling Guide</i>.</li> </ul>
	Food being cooked in a hot pan.	<ul style="list-style-type: none"> <li>• For best results, use a pan designed for broiling. Make sure it is cool.</li> </ul>
	Cookware not suited for broiling.	<ul style="list-style-type: none"> <li>• For best results, use a pan designed for broiling.</li> </ul>
	Oven bottom not securely seated in position.	<ul style="list-style-type: none"> <li>• See the <i>Installation of the range</i> section.</li> </ul>
Upper oven temperature too hot or too cold	Oven thermostat needs adjustment.	<ul style="list-style-type: none"> <li>• See the <i>Adjust the upper oven thermostat—Do it yourself!</i> section.</li> </ul>
Clock and timer do not work	Plug on range is not completely inserted in the electrical outlet.	<ul style="list-style-type: none"> <li>• Make sure electrical plug is plugged into a live, properly grounded outlet.</li> </ul>
	A fuse in your home may be blown or the circuit breaker tripped.	<ul style="list-style-type: none"> <li>• Replace the fuse or reset the circuit breaker.</li> </ul>
	Oven controls improperly set.	<ul style="list-style-type: none"> <li>• See the <i>Using the clock and timer</i> section.</li> </ul>
Upper oven light does not work	Light bulb is loose or defective.	<ul style="list-style-type: none"> <li>• Tighten or replace the bulb.</li> </ul>
	Plug on range is not completely inserted in the electrical outlet.	<ul style="list-style-type: none"> <li>• Make sure electrical plug is plugged into a live, properly grounded outlet.</li> </ul>
Upper oven will not self-clean	The oven temperature is too high to set a self-clean operation.	<ul style="list-style-type: none"> <li>• Allow the range to cool to room temperature and reset the controls.</li> </ul>
	Oven controls improperly set.	<ul style="list-style-type: none"> <li>• See the <i>Using the self-cleaning upper oven</i> section.</li> </ul>
	On models with a door latch, the oven door is not in the locked position.	<ul style="list-style-type: none"> <li>• Make sure you move the door latch handle all the way to the right.</li> </ul>
"Crackling" or "popping" sound	This is the sound of the metal heating and cooling during both the cooking and cleaning functions.	<ul style="list-style-type: none"> <li>• This is normal.</li> </ul>

<b>Problem</b>	<b>Possible Causes</b>	<b>What To Do</b>
<i>Excessive smoking</i>	Excessive soil.	<ul style="list-style-type: none"> <li>Touch the <b>Clear/Off</b> pad. Open the windows to rid the room of smoke. Wait until the <b>LOCKED DOOR</b> light goes off. Wipe up the excess soil and reset the clean cycle.</li> </ul>
<i>Oven door will not open after a clean cycle</i>	Oven too hot.	<ul style="list-style-type: none"> <li>Allow the oven to cool below locking temperature. Do not lock the door with the door latch except when using the self-clean feature.</li> </ul>
<i>Oven not clean after a clean cycle</i>	Oven controls not properly set.	<ul style="list-style-type: none"> <li>See the <i>Using the self-cleaning upper oven</i> section.</li> </ul>
	Oven was heavily soiled.	<ul style="list-style-type: none"> <li>Clean up heavy spillovers before starting the clean cycle. Heavily soiled ovens may need to self-clean again or for a longer period of time.</li> </ul>
<i>"Door" appears in the display (on models with a door latch)</i>	Latch handle was moved to the right but a program other than self-clean was selected.	<ul style="list-style-type: none"> <li>Move the latch handle to the right only when setting the self-cleaning cycle.</li> </ul>
<i>"LOCK DOOR" flashes in the display</i>	The self-clean cycle has been selected but the door is not closed and on models with a latch, the latch was not moved all the way to the right.	<ul style="list-style-type: none"> <li>Close the oven door and on models with a latch, move the latch all the way to the right.</li> </ul>
<i>LOCKED DOOR light is on when you want to cook</i>	The oven door is locked because the temperature inside the oven has not dropped below the locking temperature.	<ul style="list-style-type: none"> <li>Touch the <b>Clear/Off</b> pad. Allow the oven to cool and then, on models with a door latch, unlock the door.</li> </ul>
<i>"F—and a number or letter" flash in the display</i>	On models with a door latch, if a function error code appears during the self-cleaning cycle, check the oven door latch.	<ul style="list-style-type: none"> <li>The latch may have been moved, even if only slightly, from the locked position. Make sure the latch is moved to the right as far as it will go.</li> </ul>
	You have a function error code.	<ul style="list-style-type: none"> <li>Touch the <b>Clear/Off</b> pad. Allow the oven to cool for one hour. Put the oven back into operation.</li> </ul>
	If the function code repeats.	<ul style="list-style-type: none"> <li>Disconnect all power to the range for 5 minutes and then reconnect power. If the function error code repeats, call for service.</li> </ul>
<i>Oven shelves are difficult to slide</i>	The nickel shelves (if so equipped) were cleaned in a self-clean cycle. The gray porcelain-coated shelves (if so equipped) were improperly cleaned.	<ul style="list-style-type: none"> <li>Apply a small amount of vegetable oil to a paper towel and wipe the edges of the oven shelves with the paper towel. Do not spray with Pam® or other lubricant sprays.</li> </ul>
<i>"Probe" appears in the display (some models)</i>	This is reminding you to enter a probe temperature after plugging in the probe.	<ul style="list-style-type: none"> <li>Enter a probe temperature.</li> </ul>
<i>Water remaining on oven floor after steam clean cycle</i>	This is normal	<ul style="list-style-type: none"> <li>Remove any remaining water with a dry cloth or sponge.</li> </ul>

## Before you call for service...



### Troubleshooting Tips

Problem	Possible Causes	What To Do
Display goes blank	A fuse in your home may be blown or the circuit breaker tripped.	<ul style="list-style-type: none"> <li>Replace the fuse or reset the circuit breaker.</li> </ul>
	The clock is in the black-out mode.	<ul style="list-style-type: none"> <li>See the Special features of your oven control section.</li> </ul>
Display flashes	Power failure.	<ul style="list-style-type: none"> <li>Reset the clock.</li> </ul>
Unable to get the display to show "SF"	Oven control pads were not pressed properly.	<ul style="list-style-type: none"> <li>The <b>Bake</b> and <b>Broil Hi/Lo</b> pads must be touched at the same time and held for 3 seconds.</li> </ul>
Power outage, clock flashes	Power outage or surge.	<ul style="list-style-type: none"> <li>Reset the clock. If the oven was in use, you must reset it by touching the Clear/Off pad, setting the clock and resetting any cooking function.</li> </ul>
"Burning" or "oily" odor emitting from the vent	This is normal in a new oven and will disappear in time.	<ul style="list-style-type: none"> <li>To speed the process, set a self-clean cycle for a minimum of 3 hours. See the <i>Using the self-cleaning oven</i> section.</li> </ul>
Strong odor	An odor from the insulation around the inside of the oven is normal for the first few times the oven is used.	<ul style="list-style-type: none"> <li>This is temporary.</li> </ul>
Fan noise (some models)	A cooling fan may turn on.	<ul style="list-style-type: none"> <li>This is normal. The cooling fan will turn on to cool internal parts. It may run for up to 1 1/2 hrs after the oven is turned off.</li> </ul>
Drawer does not slide smoothly or drags	The drawer is out of alignment.	<ul style="list-style-type: none"> <li>Fully extend the drawer and push it all the way in. See the Care and cleaning of the range section.</li> </ul>
	Drawer is over-loaded or load is unbalanced.	<ul style="list-style-type: none"> <li>Reduce weight. Redistribute drawer contents.</li> </ul>
Lower oven drawer or warming drawer will not work	A fuse in your home may be blown or the circuit breaker tripped.	<ul style="list-style-type: none"> <li>Replace the fuse or reset the circuit breaker.</li> </ul>
	The oven is self-cleaning.	<ul style="list-style-type: none"> <li>Wait for the self-clean cycle to finish and the oven to cool.</li> </ul>
	Controls improperly set.	<ul style="list-style-type: none"> <li>See the <i>Electric warming drawer</i> or <i>Lower oven drawer</i> section.</li> </ul>
Excessive condensation in the drawer	Liquid in drawer.	<ul style="list-style-type: none"> <li>Remove liquid.</li> </ul>
	Uncovered foods.	<ul style="list-style-type: none"> <li>Cover food with lid or aluminum foil.</li> </ul>
	Temperature setting too high.	<ul style="list-style-type: none"> <li>Reduce temperature setting.</li> </ul>
Food dries out in the lower oven drawer or warming drawer	Moisture escaping.	<ul style="list-style-type: none"> <li>Cover food with lid or aluminum foil.</li> </ul>
	Drawer not fully closed.	<ul style="list-style-type: none"> <li>Push drawer in until latch engages.</li> </ul>



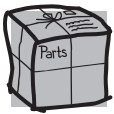

**Looking For Something More? (Not all accessories are available for all models.)**

You can find these accessories and many more at [GEAppliances.com](http://GEAppliances.com) (U.S.) or [www.GEAppliances.ca](http://www.GEAppliances.ca) (Canada), or call **800.626.2002** (U.S.) or **800.661.1616** (Canada) (during normal business hours). Have your model number ready.

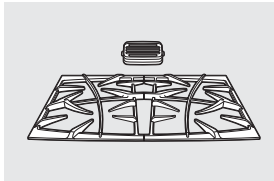

Grates

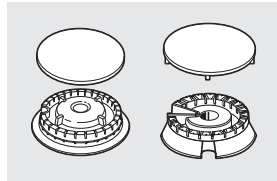

Surface Burner Heads and Caps

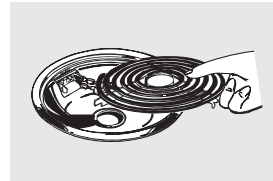

Surface Elements and Drip Pans

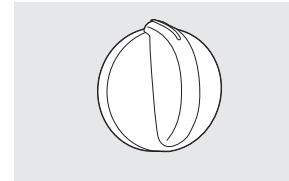

Knobs

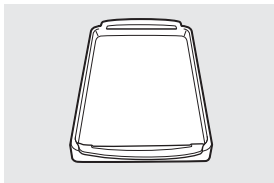

Griddle

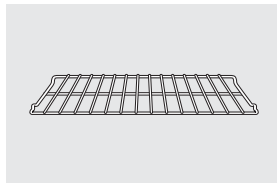

Oven Racks

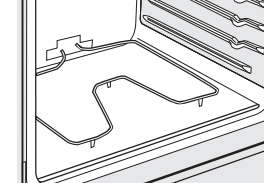

Oven Elements

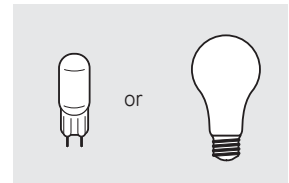

Light Bulbs

**Experience these other great products to keep your kitchen looking great!**



Ceramic Cooktop Cleaning Kit: Includes cleaner, scraper and pad

WX10X117GCS



Ceramic Cooktop Cleaning Wipes

WX10X305



Stainless Steel Appliance Polish Wipes

WX10X10001



Stainless Steel Appliance Cleaner

PM10X311

**Get the most out of your Broiler Pan! (Not for use with Broiler Drawer models.)**

Use your pan and grid cover to broil hamburgers, seafood, steaks, vegetables, bacon, chops and so much more! The pan below catches the excess fats and oils.

- Genuine GE Part
- Easy To Clean
- One-Year Warranty

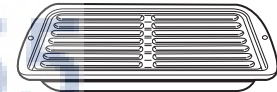

**Limited Time Offer! Free Shipping!**

When you order your broiler pan **within 30 days** of purchasing your GE cooking product.

	Small	Large*	XL**
U.S. Part #	WB48X10055	WB48X10056	WB48X10057
Canada Part #	222D2097G001	222D2097G002	N/A
Dimensions	8-3/4" W x 1-1/4" H x 13-1/2" D	12-3/4" W x 1-1/4" H x 16-1/2" D	17" W x 1-1/4" H x 19-1/4" D

\* The large (standard) broil pan does not fit in 20"/24" ranges.  
 \*\* The XL pan does not fit in 24" wall ovens, 27" drop-ins or 20"/24" ranges.

To place your order, call **800.626.2002** (U.S.), **800.661.1616** (Canada) or mail this form to:  
 In the U.S.: GE Parts, P.O. Box 221027, Memphis, TN 38122-1027. In Canada: GE Parts, 1 Factory Lane, Moncton, N.B. E1C 9M3

**Broiler Pan Order Form**

Quantity \_\_\_\_\_ Part Number \_\_\_\_\_

\_\_\_\_\_

\_\_\_\_\_

Model Number \_\_\_\_\_ Serial Number \_\_\_\_\_ Brand \_\_\_\_\_ Date of Purchase \_\_\_\_\_

First Name \_\_\_\_\_ Last Name \_\_\_\_\_

Address \_\_\_\_\_

City \_\_\_\_\_ State \_\_\_\_\_ Zip Code \_\_\_\_\_

Phone \_\_\_\_\_ E-Mail \_\_\_\_\_

Check \_\_\_\_\_ Money Order \_\_\_\_\_

Call 800.626.2002 in the U.S. or 800.661.6161 in Canada for current pricing. All credit card orders must be called in.

# GE Gas Range Warranty. *(For customers in the United States)*



All warranty service provided by our Factory Service Centers, or an authorized Customer Care® technician. To schedule service, on-line, 24 hours a day, visit us at [GEAppliances.com](http://GEAppliances.com), or call 800.GE.CARES (800.432.2737). Please have serial number and model number available when calling for service.

Staple your receipt here.  
Proof of the original purchase date is needed to obtain service under the warranty.

## For The Period Of: GE Will Replace:

### One Year

From the date of the original purchase

**Any part** of the range which fails due to a defect in materials or workmanship. During this **limited one-year warranty**, GE will also provide, **free of charge**, all labor and in-home service to replace the defective part.

## What GE Will Not Cover:

- Service trips to your home to teach you how to use the product.
- Improper installation, delivery or maintenance.
- Product damage or failure of the product if it is abused, misused, modified, used for other than the intended purpose, or used commercially.
- Replacement of house fuses or resetting of circuit breakers.
- Damage to the product caused by accident, fire, floods or acts of God.
- Incidental or consequential damage caused by possible defects with this appliance.
- Damage caused after delivery.
- Product not accessible to provide required service.

**EXCLUSION OF IMPLIED WARRANTIES—Your sole and exclusive remedy is product repair as provided in this Limited Warranty. Any implied warranties, including the implied warranties of merchantability or fitness for a particular purpose, are limited to one year or the shortest period allowed by law.**

This warranty is extended to the original purchaser and any succeeding owner for products purchased for home use within the USA. If the product is located in an area where service by a GE Authorized Servicer is not available, you may be responsible for a trip charge or you may be required to bring the product to an Authorized GE Service Location for service. In Alaska, the warranty excludes the cost of shipping or service calls to your home.

Some states do not allow the exclusion or limitation of incidental or consequential damages. This warranty gives you specific legal rights, and you may also have other rights which vary from state to state. To know what your legal rights are, consult your local or state consumer affairs office or your state's Attorney General.

Warrantor: General Electric Company. Louisville, KY 40225

## GE Gas Range Warranty. (For customers in Canada)



All warranty service provided by our Factory Service Centers or an authorized Customer Care® technician. For service, call 1.800.561.3344. Please have serial number and model number available when calling for service.

Staple your receipt here. Proof of the original purchase date is needed to obtain service under the warranty.

### For The Period Of: Mabe Will Replace:

**One Year**  
From the date of the original purchase

**Any part** of the range which fails due to a defect in materials or workmanship. During this **limited one-year warranty**, Mabe will also provide, **free of charge**, all labor and in-home service to replace the defective part.

### What Mabe Will Not Cover:

- Service trips to your home to teach you how to use the product.
- Improper installation, delivery or maintenance.
- Product damage or failure of the product if it is abused, misused, modified, used for other than the intended purpose, or used commercially.
- Replacement of house fuses or resetting of circuit breakers.
- Damage to the product caused by accident, fire, floods or acts of God.
- Incidental or consequential damage caused by possible defects with this appliance.
- Damage caused after delivery.
- Product not accessible to provide required service.

**EXCLUSION OF IMPLIED WARRANTIES**—Your sole and exclusive remedy is product repair as provided in this Limited Warranty. Any implied warranties, including the implied warranties of merchantability or fitness for a particular purpose, are limited to one year or the shortest period allowed by law.

WARRANTOR IS NOT RESPONSIBLE FOR CONSEQUENTIAL DAMAGES.

Warrantor: MABE CANADA INC.

# Consumer Support.

---



## GE Appliances Website

In the U.S.: **GEAppliances.com**

Have a question or need assistance with your appliance? Try the GE Appliances Website 24 hours a day, any day of the year! For greater convenience and faster service, you can now download Owner's Manuals, order parts or even schedule service on-line. **In Canada: [www.GEAppliances.ca](http://www.GEAppliances.ca)**



## Schedule Service

In the U.S.: **GEAppliances.com**

Expert GE repair service is only one step away from your door. Get on-line and schedule your service at your convenience 24 hours any day of the year! Or call 800.GE.CARES (800.432.2737) during normal business hours.

**In Canada, call 1.800.561.3344**



## Real Life Design Studio

In the U.S.: **GEAppliances.com**

GE supports the Universal Design concept—products, services and environments that can be used by people of all ages, sizes and capabilities. We recognize the need to design for a wide range of physical and mental abilities and impairments. For details of GE's Universal Design applications, including kitchen design ideas for people with disabilities, check out our Website today. For the hearing impaired, please call 800.TDD.GEAC (800.833.4322).

**In Canada, contact:** Manager, Consumer Relations, Mabe Canada Inc.  
Suite 310, 1 Factory Lane  
Moncton, N.B. E1C 9M3



## Extended Warranties

In the U.S.: **GEAppliances.com**

Purchase a GE extended warranty and learn about special discounts that are available while your warranty is still in effect. You can purchase it on-line anytime, or call 800.626.2224 during normal business hours. GE Consumer Home Services will still be there after your warranty expires. **In Canada, call 1.888.261.2133**

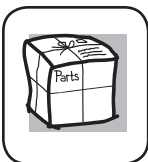

## Parts and Accessories

In the U.S.: **GEAppliances.com**

Individuals qualified to service their own appliances can have parts or accessories sent directly to their homes (VISA, MasterCard and Discover cards are accepted). Order on-line today, 24 hours every day or by phone at 800.626.2002 during normal business hours.

**Instructions contained in this manual cover procedures to be performed by any user. Other servicing generally should be referred to qualified service personnel. Caution must be exercised, since improper servicing may cause unsafe operation.**

Customers **in Canada** should consult the yellow pages for the nearest Mabe service center, or call 1.888.261.3055.



## Contact Us

In the U.S.: **GEAppliances.com**

If you are not satisfied with the service you receive from GE, contact us on our Website with all the details including your phone number, or write to:

General Manager, Customer Relations  
GE Appliances, Appliance Park  
Louisville, KY 40225

**In Canada: [www.GEAppliances.ca](http://www.GEAppliances.ca), or write to:** Director, Consumer Relations, Mabe Canada Inc.  
Suite 310, 1 Factory Lane  
Moncton, N.B. E1C 9M3



## Register Your Appliance

In the U.S.: **GEAppliances.com**

**Register your new appliance on-line—at your convenience!** Timely product registration will allow for enhanced communication and prompt service under the terms of your warranty, should the need arise. You may also mail in the pre-printed registration card included in the packing material. **In Canada: [www.GEAppliances.ca](http://www.GEAppliances.ca)**