

## Operating Instructions 36 Inch All Gas Range (gas oven and gas cooktop)



To prevent accidents and machine damage, read these instructions **before** installation or use.

# IMPORTANT SAFETY INSTRUCTIONS

## WARNING

Children and adults can tip over the range if has not been secured. This may lead to fatal injuries.



- ▶ This range must be secured and connected using the anti-tip device according to the installation instructions.
- ▶ If you have moved the range, slide the locking latch onto the anti-tip device until you feel it lock into place.
- ▶ Do not use the range if the anti-tip device has not been properly installed and engaged.
- ▶ Failure to observe the information contained in the installation instructions can lead to serious or fatal injuries for children and adults.

|  |  |
|--|--|
|  | <b> WARNING</b>   |
|  | <p>All ranges can tip</p> <p>Injury to persons could result</p> <p>Install anti-tip devices packed with range</p> <p>See installation instructions</p> |

|  |    |
|--|----|
| <b>IMPORTANT SAFETY INSTRUCTIONS</b> .....                         | 2  |
| <b>IMPORTANT SAFETY INSTRUCTIONS</b> .....                         | 5  |
| <b>Guide to the range</b> .....                                    | 20 |
| Gas cooktop HR 1134-3 AG .....                                     | 20 |
| Oven HR 1134-3 AG .....  | 21 |
| Gas cooktop HR 1135-3 AG .....                                     | 22 |
| Oven HR 1135-3 AG .....  | 23 |
| Gas cooktop HR 1136-3 AG .....                                     | 24 |
| Oven HR 1136-3 AG .....  | 25 |
| <b>Controls for the range</b> .....                                | 26 |
| Controls for gas cooktop HR 1134-3 AG .....                        | 26 |
| Controls for gas cooktops HR 1135-3 AG and HR 1136-3 AG .....      | 26 |
| Oven controls .....  | 28 |
| <b>Features</b> .....  | 31 |
| Data plate .....   | 31 |
| Scope of delivery .....  | 31 |
| Standard and optional accessories .....                            | 31 |
| Gas cooktop safety features .....                                  | 35 |
| Oven safety features .....   | 35 |
| PerfectClean treated surfaces .....                                | 35 |
| Self-Clean-ready accessories .....                                 | 36 |
| <b>Before first use</b> .....                                      | 37 |
| Before using for the first time .....                              | 37 |
| Cleaning the cooktop before heating it up for the first time ..... | 38 |
| Seasoning the griddle plate .....                                  | 38 |
| Heating the oven for the first time .....                          | 39 |
| <b>Using the gas cooktop</b> .....                                 | 41 |
| Energy-saving tips .....   | 41 |
| Suitable cookware .....  | 41 |
| Switching on the burner .....                                      | 42 |
| Switching on during a power failure .....                          | 42 |
| Adjusting the flame .....  | 43 |
| Switching off the burner .....                                     | 43 |
| Using the grill .....  | 44 |
| Using the griddle plate .....                                      | 45 |
| <b>Using the oven</b> .....  | 47 |
| Overview of operating modes .....                                  | 47 |
| Energy-saving tips .....   | 48 |

# Contents

---

|  |    |
|--|----|
| Simple operation .....   | 49 |
| Operating the clock/timer.....   | 50 |
| Switching cooking programs on and off automatically .....  | 50 |
| Changing the time of day .....   | 52 |
| Changing factory default settings .....  | 53 |
| Switching the system lock  on and off.....                    | 56 |
| Using the timer  .....  | 57 |
| <b>Baking</b> .....  | 58 |
| Tips for baking.....   | 58 |
| Notes on the operating modes.....  | 59 |
| <b>Roasting</b> .....  | 60 |
| Tips for roasting .....  | 60 |
| Notes on the operating modes.....  | 61 |
| <b>Broiling</b> .....  | 62 |
| Tips for broiling.....   | 62 |
| Notes on the operating modes.....  | 63 |
| <b>Further applications</b> .....  | 64 |
| Defrost.....   | 64 |
| Dehydrating .....  | 65 |
| Warm-up Cookware .....   | 65 |
| Slow Roasting .....  | 66 |
| Canning.....   | 68 |
| Frozen food/ready meals.....   | 70 |
| <b>Gas cooktop cleaning and care</b> .....   | 71 |
| <b>Cleaning and care of the oven</b> .....   | 75 |
| Unsuitable cleaning agents.....  | 75 |
| Removing normal soiling.....   | 76 |
| Removing stubborn soiling.....   | 76 |
| Cleaning the oven compartment with Self clean  (Clean)..... | 77 |
| Starting Self Clean.....   | 78 |
| At the end of the Self Clean program.....  | 79 |
| Self Clean interrupted.....  | 80 |
| Removing the door.....   | 81 |
| Installing the door.....   | 82 |
| Side rack removal.....   | 83 |
| <b>Frequently Asked Questions</b> .....  | 84 |
| <b>Customer Service</b> .....  | 89 |
| Contact in the event of a fault .....  | 89 |
| Appliance warranty and product registration .....  | 89 |
| <b>Caring for the environment</b> .....  | 90 |

# IMPORTANT SAFETY INSTRUCTIONS

---

**When using the appliance, follow basic safety precautions, including the following:**

**Read all instructions before installation and use of the range to prevent accidents and machine damage.**

This range complies with current safety requirements. However, improper use of the appliance can result in personal injury or damage to property.

Please read the installation instructions carefully before installing and connecting the appliance.

Read the operating instructions before using the range for the first time. To prevent accidents and damage to the appliance, always observe both the installation instructions and operating instructions. Both documents contain important information about installation, safety, use and maintenance.

Miele cannot be held liable for damage occurring as a result of non-compliance with the instructions.

Keep these installation instructions and operating instructions in a safe place and pass them on to any future owner.

# IMPORTANT SAFETY INSTRUCTIONS

---

## Appropriate use

- ▶ This range is intended for domestic use and use in other similar environments.
- ▶ This appliance is not intended for outdoor use.
- ▶ Use the range exclusively under normal domestic conditions:
  - Use the oven for baking, roasting, broiling, defrosting, canning and drying food.
  - Use the cooktop to prepare food and keep it warm.

Any other use is not permitted.

- ▶ Risk of Fire! Do not use this oven to store or dry combustible materials.
- ▶ Persons who lack physical, sensory or mental abilities, or experience with the appliance should not use it without supervision or instruction by a responsible person.
- ▶ The oven compartment is equipped with special bulbs to cope with particular conditions (e.g., temperature, moisture, chemical resistance, abrasion resistance, and vibration). These special bulbs must only be used for the purpose for which they are intended. They are not suitable for room lighting.

## Safety with children

- ▶ Children should be supervised in the vicinity of the range. Never allow children to play with the range.
- ▶ Children must be kept away from the range unless they are constantly supervised.
- ▶ Risk of burns due to improper use. Do not allow children to operate the range.
- ▶ Burn Hazard - Do not allow children to use the oven. Failure to do so can result in severe burns or serious injury.
- ▶ Burn Hazard - Do not allow children to use the cooktop. Failure to do so can result in severe burns or serious injury.

## IMPORTANT SAFETY INSTRUCTIONS

---

- ▶ Risk of suffocation from packaging material. While playing, children may become entangled in packaging material (such as plastic wrapping) or pull it over their head, presenting the risk of suffocation. Keep packaging material away from children.
- ▶ Risk of injury caused by hot surfaces. Children's skin is far more sensitive to high temperatures than that of adults. External parts of the oven such as the door glass, control panel, and the vent become quite hot. Do not let children touch the oven when it is in operation.
- ▶ Risk of injury caused by hot surfaces. Children's skin is far more sensitive to high temperatures than that of adults. The oven gets much hotter during the Self Clean program than during normal use. Do not let children touch the oven during the Self Clean program.
- ▶ The cooktop gets hot when in use and remains hot for some time after being turned off. Keep children away from the appliance until it has cooled down and is no longer a burn hazard.
- ▶ Burn hazard!  
Keep the spaces above and behind the cooktop clear of any items that could draw the attention of children. Otherwise, they can be tempted into climbing onto the appliance.
- ▶ Risk of injury from the open door. The oven door can support a maximum weight of 33 lbs (15 kg). Children could injure themselves on an open door.  
Do not let children sit on the door, lean against it, or swing on it.
- ▶ Risk of burning or scalding.  
Turn pot and pan handles inward, so children cannot pull them down and be burned.

### **Technical safety**

- ▶ This appliance must be installed and connected in compliance with the installation instructions.
- ▶ Unauthorized installation, maintenance, and repairs can cause considerable danger for the user. Installation, maintenance, and repairs should only be carried out by a Miele authorized technician.

## IMPORTANT SAFETY INSTRUCTIONS

---

- ▶ Do not carry or lift the range by the oven door handle or the control panel!
- ▶ Maintenance by the user: Never repair or replace any part of the appliance unless the instructions specifically recommend doing so. Service work should only be performed by a qualified technician.
- ▶ A damaged range can be dangerous. Always check for visible signs of damage. Never use a damaged appliance.
- ▶ Temporary or permanent operation on an autonomous power supply system or a power supply system that is not synchronized with the grid power supply (e.g., island networks, back-up systems) is possible. A prerequisite for operation is that the power supply system complies with the specifications of EN 50160 or an equivalent standard.

The function and operation of the protective measures provided in the domestic electrical installation and in this Miele product must also be maintained in isolated operation or in operation that is not synchronized with the grid power supply, or these measures must be replaced by equivalent measures in the installation. As described, for example, in the current version of VDE-AR-E 2510-2.

- ▶ The electrical safety of the range can only be guaranteed when it is properly grounded. Compliance with this essential safety requirement is absolutely mandatory. If in any doubt, please have the building's wiring system inspected by a qualified electrician.
- ▶ Proper installation: Make sure that your appliance has been installed correctly and that it has been grounded by a qualified technician.
- ▶ To avoid damaging the range, make sure that the connection data (voltage and frequency) on the data plate correspond to the building's power supply before connecting the appliance. When in doubt, consult a qualified electrician.
- ▶ Installation and maintenance of the gas connection must be performed by qualified installers, service agencies or gas providers.



## IMPORTANT SAFETY INSTRUCTIONS

- ▶ During installation, maintenance and repair work, e.g. if the oven lighting is broken, the range must be completely disconnected from the power supply (see “Frequently asked questions”). The gas inlet valve must be closed. It is only completely isolated from the supply when:
  - The circuit breakers have been switched off, or
  - the fuses of the electrical installation have been completely removed, or
  - the plug (if present) is removed from the outlet. To do this, pull the plug not the cord.
  - Shut off the gas supply and disconnect the range from the gas supply. Installation and maintenance of the gas connection must be performed by qualified installers, service agencies or gas providers.
- ▶ Do not use a power strip or extension cord to connect the range to electricity. These are a fire hazard and do not guarantee the required level of appliance safety.
- ▶ For safety reasons, only use the range when it has been fully installed.
- ▶ This range must not be installed and operated in non-stationary installations (e.g., on a ship).
- ▶ Risk of injury due to electric shock. Any contact with live connections or tampering with the electrical or mechanical components of the range will endanger your safety and may lead to appliance malfunctions.  
Do not open the range housing under any circumstances.
- ▶ Any repairs not performed by a Miele authorized service technician will void the warranty.
- ▶ Miele can only guarantee the safety of the appliance when original Miele parts are used. Faulty components must only be replaced with genuine Miele parts.
- ▶ If the power cord is damaged, it must be replaced with a special power cord by a Miele authorized technician (see “Installation – Electrical connection”).

## IMPORTANT SAFETY INSTRUCTIONS

---

- ▶ Danger of electric shock.

If the cooktop is defective, immediately turn the appliance off and discontinue use. Disconnect it from the electricity and gas supply. Contact Customer Service.

- ▶ The range requires a sufficient supply of cool air for efficient operation. Make sure that the supply of cool air is not hindered in any way (e.g., by installing heat insulation strips in the cabinet niche). In addition, the required supply of cool air must not be excessively heated by other heat sources.

- ▶ Reaching over a hot cooktop to access the cabinets can result in burns. You can reduce the risk of burns by installing a range hood that extends at least 4 3/4" (12 cm) past the bottom of the cabinets.

### Correct use

- ▶ Caution: Heating elements may be hot even though they are not glowing. Interior surfaces of an oven become hot enough to cause burns. External parts of the oven such as the door glass, vents, and the control panel can become hot. During and after use, do not touch, or let clothing or other flammable materials come into contact with heating elements or interior surfaces of the oven until they have had sufficient time to cool.

#### Burn hazard!

Hot vapors are emitted above the island trim during Self Clean as well as when cooking food in the oven. You could burn yourself on the hot vapors.

Do not reach above the island trim and keep others away from it when you are using the oven.

- ▶ Hot vapors are emitted above the island trim during Self Clean as well as when cooking food in the oven.

The emission of vapors can soil and discolor surfaces above the island trim. Take precautions to protect sensitive surfaces such as marble, granite, and tiles against soiling and discoloration (surfaces of this nature can be difficult or even impossible to clean).

## IMPORTANT SAFETY INSTRUCTIONS

- ▶ Do not let food sit in the oven for an extended period of time before or after cooking. Doing so can result in food poisoning or sickness.
- ▶ Loose fitting or hanging garments present a fire hazard. Wear proper apparel while operating the appliance.
- ▶ Use only dry, heat-resistant potholders. Moist or damp potholders used on hot surfaces may result in steam burns. Do not let potholders come in contact with oil or grease. Do not substitute dish towels or other bulky items for potholders. Do not let potholders touch hot heating elements.
- ▶ Open the door carefully to allow hot air or steam to escape before placing or removing food.
- ▶ To prevent burns, always place oven racks at their desired height while the oven is cool. If the rack must be moved while the oven is hot, do not let pot holders touch hot heating elements.
- ▶ To prevent burns, allow the heating elements to cool before cleaning by hand.
- ▶ Smother the fire or flames, or use a dry chemical extinguishing agent or foam fire extinguisher.
- ▶ Never store flammable liquids and materials in, above or under an oven, or near cooking surfaces.

### WARNING

NEVER use this appliance as a space heater to heat or warm the room. Doing so may result in carbon monoxide poisoning and overheating of the oven.

### WARNING

NEVER use this appliance as storage space. Doing so may result in carbon monoxide poisoning and overheating of the oven.

## IMPORTANT SAFETY INSTRUCTIONS

### WARNING

NEVER cover any slots, holes or openings in the oven bottom or cover an entire rack with materials such as aluminum foil. Doing so blocks air flow through the oven and may cause carbon monoxide poisoning. Aluminum foil linings may also trap heat, causing a fire hazard.

- ▶ Do not obstruct the flow of combustion and ventilation air.
- ▶ This oven must only be used for cooking food. Corrosive chemicals and vapors as well as fumes, vapors or heat given off by glues, plastics or flammable liquids and materials could be hazardous. Do not use it as a dryer, kiln, dehumidifier, etc.
- ▶ Do not let metal objects (aluminum foil, pans) come in contact with the heating element.
- ▶ Make certain that the power cords of small appliances do not come in contact with or get caught in the oven door.
- ▶ When baking frozen pizzas or pies, place them on the wire rack lined with parchment paper. Do not use the baking tray or the roasting pan for frozen foods with a large surface area. The tray or pan could become warped and difficult to remove from the oven when hot. Frozen foods like french fries, chicken nuggets, etc. can be baked on the baking tray.
- ▶ Risk of injury caused by hot surfaces. The oven gets hot during operation. You could burn yourself on the heating elements, oven compartment, accessories, or food.  
When the oven is hot, use pot holders to insert, remove, or turn food, as well as when adjusting the oven shelves, etc.
- ▶ The high temperatures radiated could cause objects near the oven to catch fire.  
Do not use the oven to heat the room.
- ▶ Oils and fats are a fire hazard if allowed to overheat. Never leave the oven unattended when cooking with oil or fats. Never attempt to put out oil or fat fires with water. Turn the oven off and extinguish the flames by leaving the door closed.

## IMPORTANT SAFETY INSTRUCTIONS

---

- ▶ Do not use water on cooktop grease fires. Turn the cooktop off. Smother or use a dry chemical or foam-type extinguisher on any fire or flame.
- ▶ Broiling food for excessively long cooking durations can cause it to dry out with the risk of catching fire. Do not exceed the recommended cooking durations.
- ▶ Certain foods dry out quickly and may catch fire due to high broiling temperatures.  
Never use broiling modes to finish baking par-cooked rolls or bread, or to dry flowers or herbs. Use the Convection Bake  (Conv Bake) operating mode.
- ▶ If using alcohol in your recipes, please be aware that high temperatures can cause the alcohol to evaporate. The vapor can catch fire on hot heating elements.
- ▶ Plastic or aluminum foil cookware melts at high temperatures and can damage the range or start to burn. Do not use any plastic or aluminum foil cookware.  
Exception: You can use oven-safe plastic cookware in the oven. Heed the cookware manufacturer's instructions.
- ▶ When using residual heat to keep food warm, corrosion from high air humidity and condensation can occur in the oven. This can cause damage to the control panel, countertop, and cabinet carcass. Keep the oven on and select the lowest temperature available for the selected operating mode. The cooling fan will then continue to run automatically.
- ▶ Food which is stored in the oven compartment or left in it to be kept warm can dry out and the moisture released can lead to corrosion damage in the oven. Always cover food that is left in the oven to keep warm.

## IMPORTANT SAFETY INSTRUCTIONS

---

▶ A buildup of heat can cause the floor of the oven to crack or flake off.

Never line the floor of the oven with aluminum foil or oven liners. If you wish to place dishware on the floor of the oven during the cooking process, or place dishware on the floor of the oven to heat it up, you can do so, but only with the Convection Bake  (Conv Bake) operating mode.

▶ The oven floor can become damaged by items being pushed around on it. When placing pots, pans, or dishware on the oven floor, do not push them around.

▶ Risk of injury caused by steam. Pouring a cold liquid onto a hot surface creates steam, which can cause severe scalding. The sudden temperature change can also cause damage to hot surfaces. Never pour cold liquids directly onto hot enameled surfaces.

▶ It is important that the temperature in the food being cooked is evenly distributed and sufficiently high. You can ensure this by stirring or turning the food.

▶ Canning food and heating it up in closed containers results in an increase in pressure which can cause them to explode. Do not use cans for canning or reheating food.

▶ Risk of injury from the open door. You could bang into the open door or trip over it. Do not leave the door open unnecessarily.

▶ The door can support a maximum load of 33 lbs (15 kg). Do not lean or sit on an open door, or place heavy items on it. Make sure that nothing gets trapped between the door and the oven compartment. This could damage the oven.

▶ The flames could set the grease filters of a ventilation hood on fire. Do not flambé under a ventilation hood.

▶ Never heat empty cookware.

▶ If the cooktop is covered, there is a risk that the material of the cover will ignite, explode or melt if the cooktop is still hot or if turned on inadvertently. Never cover the cooktop with a board, cloth or protective sheet.

## IMPORTANT SAFETY INSTRUCTIONS

---

- ▶ When using an electric appliance, e.g. a hand mixer, near the cooktop, make sure that the power cable does not come into contact with the hot cooktop. The cable's insulation could become damaged.
- ▶ The cooktop gets hot when in use and remains hot for some time after being turned off. Do not touch the appliance if there is a possibility that it could still be hot.
- ▶ When the appliance is turned on inadvertently or by mistake, or when there is residual heat present, there is a risk of the metal items heating up. Other materials can melt or catch fire when the appliance is switched on. Do not store items on the cooktop.
- ▶ Metallic objects such as knives, forks, spoons and lids should not be placed on the cooktop surface since they can get hot.
- ▶ Wet sponges or clothes can cause burns due to hot steam if they are used to wipe spilled food off a hot burner. Some cleansers can emit hazardous vapors if they are applied to a hot surface. Be careful when cleaning the cooktop.
- ▶ Spilled food can cause odors and the spraying of grease, which can ignite on the cooktop. Never leave the cooktop unsupervised at high power.
- ▶ If the handles of a pot or pan extend across an adjacent burner, this can cause burns, the ignition of flammable materials and the spilling of food due to inadvertent contact with the cookware. Turn the pot or pan so that the handles point toward the inside and do not extend across an adjacent burner.
- ▶ Ensure that the igniters are clean and dry to allow the burners to ignite and burn properly.
- ▶ A range hood installed above the cooktop can become damaged or catch fire as a result of intense heat. Do not use the gas burners without cookware.
- ▶ Only light the gas burners after all burner parts have been properly assembled.

## IMPORTANT SAFETY INSTRUCTIONS

---

- ▶ If the cookware is too small, it will not sit properly on the burner grate. If the cookware is too large, heat emitted from the bottom of the cookware may damage the countertop, walls with poor heat-resistance (e.g. paneled walls) or portions of the cooktop.
- ▶ Make sure that the burner flames do not extend beyond the bottom of the cookware and rise up its sides.
- ▶ Only use cookware with a thick enough bottom. Failure to do so may result in damage to the cooktop.
- ▶ Always use the burner grates supplied with the cooktop. Never place cookware directly on the burner.
- ▶ Install the burner grates in an upright position to avoid scratching the cooktop.
- ▶ Remove all grease splatters and other flammable (food) residues on the cooktop. They are a fire hazard.
- ▶ Using of a gas cooktop causes heat, moisture and products of combustion to build up in the room in which it is installed. Make sure that your kitchen is well ventilated, especially when the appliance is in use: keep any natural means of ventilation open or install a mechanical ventilation system (e.g. a ventilation hood).
- ▶ If the cooktop is used for very long periods of time, additional ventilation of the room may be necessary, e.g. by opening windows or doors, or running the ventilation on the highest setting.
- ▶ Do not use pots or pans that are large enough to cover several burners. The resulting heat buildup can damage the appliance.
- ▶ If the cooktop has not been used for a long period of time, be sure to thoroughly clean it and have it inspected by an authorized technician before using it again.
- ▶ When you have finished cooking, make sure that the burners and oven are turned off by checking the position of the knobs.
- ▶ Only certain types of glass, ceramic or other enamel cookware can be used on a gas cooktop without breaking as a result of sudden temperature changes.



## IMPORTANT SAFETY INSTRUCTIONS

---

- ▶ Do not use cooking utensils on the grill.
- ▶ Ask your installer to show you the location of your gas shutoff valve and fuses or circuit breaker panel in your apartment or home. Be sure that you know how and where to disconnect the gas and power supply to your cooktop.
- ▶ The grates, burner cap, bottom parts of the burner, and any other parts located near the burner flame, can still be very hot after cooking and cause burns. Do not touch these components when using the cooktop.
- ▶ Wind can blow curtains over the cooktop, causing them to catch fire. If the cooktop is installed near a window, do not use long curtains.
- ▶ Not any cookware of glass, glass ceramic, ceramic, clay or other glass cookware is suitable for use on a burner. It can be damaged due to sudden temperature change.

### **The following applies to stainless steel surfaces:**

- ▶ Adhesives will damage the coated stainless steel surface and cause it to lose its dirt-repellent protective coating. Do not use sticky notes, adhesive tape, or other types of adhesive on the stainless steel surface.
- ▶ Magnets can cause scratches. Do not use the stainless steel surface as a magnetic notice board.

# IMPORTANT SAFETY INSTRUCTIONS

---

## Cleaning and care

- ▶ Only clean parts listed in these operating and installation instructions.
- ▶ There is a delicate fiberglass seal around front of the oven compartment provide a seal for the glass on the inside of the oven door. This can be damaged by rubbing or scouring. If possible, refrain from cleaning this.
- ▶ Do not use oven cleaners. Do not use standard oven cleaners in the oven compartment or on the front of the oven. Never line the oven with oven liners.
- ▶ Risk of injury due to electric shock. The steam from a steam cleaning appliance could reach live electrical components and cause a short circuit. Never use a steam cleaner for cleaning.
- ▶ Scratches on the door glass can cause the glass to break. Do not use abrasive cleaners, hard sponges, brushes, or sharp metal tools to clean the door glass.
- ▶ The side runners can be removed (see “Cleaning and care of the oven – Removing the side runners”). Reinstall the side runners correctly.
- ▶ Coarse soiling in the oven compartment can cause thick smoke to develop. Remove coarse soiling from the oven compartment before running the Self Clean program.
- ▶ In warm, moist environments, there is a higher probability of pest infestations. Ensure the oven and the area surrounding it are always kept clean.  
Damage caused by pests is not covered by the warranty.

# IMPORTANT SAFETY INSTRUCTIONS

---

## Accessories

- ▶ Only use original Miele accessories. Using parts or accessories from other manufacturers will invalidate the warranty, and Miele cannot accept liability.
- ▶ Accessories that are not suitable for the Self Clean program will be damaged by the high temperatures. Remove all accessories that are not suitable for the Self Clean program from the oven compartment before starting the Self Clean process. This also applies to optional accessories that are not suitable for the Self Clean program (see “Cleaning and care of the oven”).

**KEEP THE OPERATING AND INSTALLATION INSTRUCTIONS IN A SAFE PLACE AND REVIEW THEM PERIODICALLY.**

# Guide to the range

## Gas cooktop HR 1134-3 AG

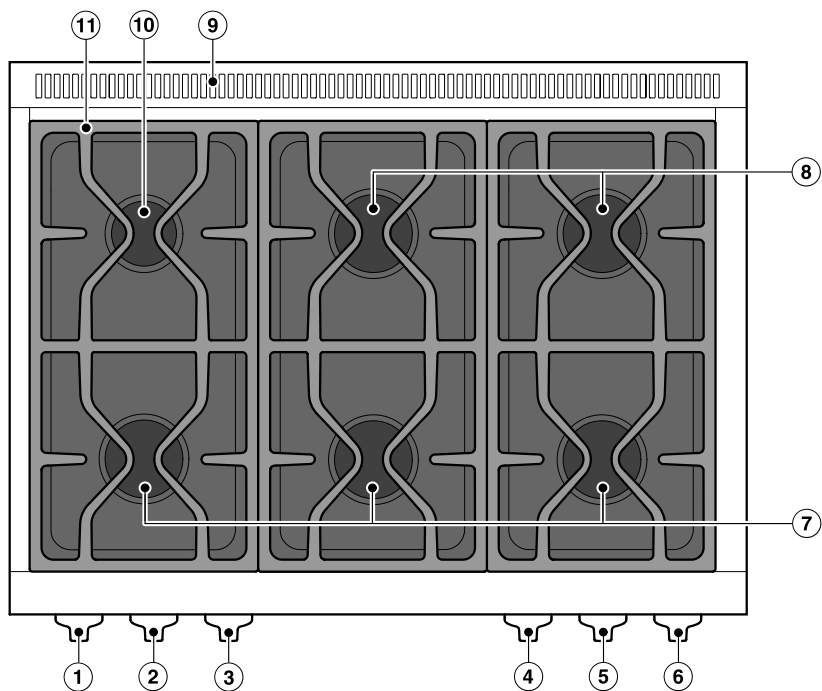

- ① Control knob  
Rear left burner
- ② Control knob  
Front left burner
- ③ Control knob  
Front middle burner
- ④ Control knob  
Rear middle burner
- ⑤ Control knob  
Front right burner
- ⑥ Control knob  
Rear right burner
- ⑦ Extra large burner, front
- ⑧ Extra large burner, rear
- ⑨ Island trim
- ⑩ Power burner
- ⑪ Grates

## Oven HR 1134-3 AG

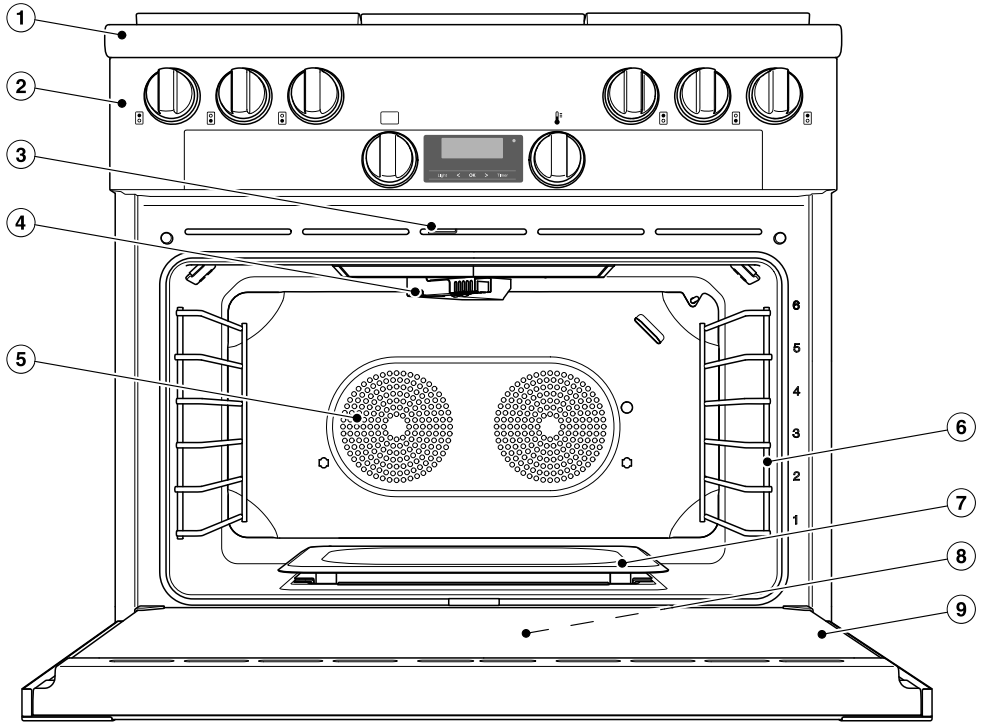

- ① Gas cooktop
- ② Controls
- ③ Door lock for Self Clean
- ④ Browning/Broiling element
- ⑤ Air inlets for the blowers with ring heating elements behind them
- ⑥ Side runners with 6 shelf levels
- ⑦ Oven floor with bottom heat element underneath it
- ⑧ Data plate  
The data plate is located behind the toe-kick panel
- ⑨ Door

# Guide to the range

## Gas cooktop HR 1135-3 AG

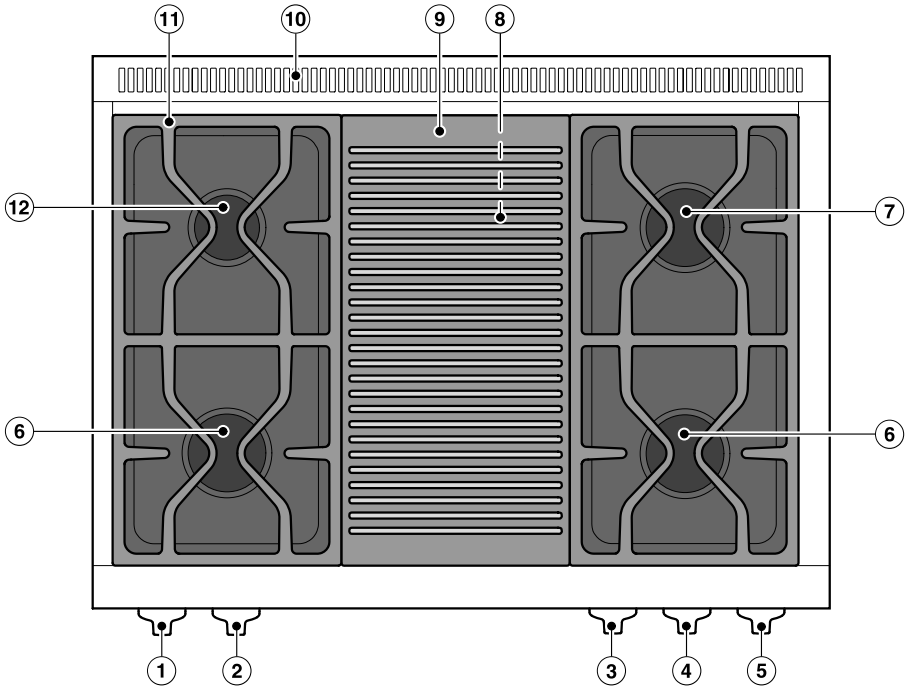

- ① Control knob  
Rear left burner
- ② Control knob  
Front left burner
- ③ Control knob for grill
- ④ Control knob  
Front right burner
- ⑤ Control knob  
Rear right burner
- ⑥ Extra large burner, front
- ⑦ Extra large burner, rear
- ⑧ Thermostatically controlled ceramic burner
- ⑨ Grill
- ⑩ Island trim
- ⑪ Grates
- ⑫ Power burner

## Oven HR 1135-3 AG

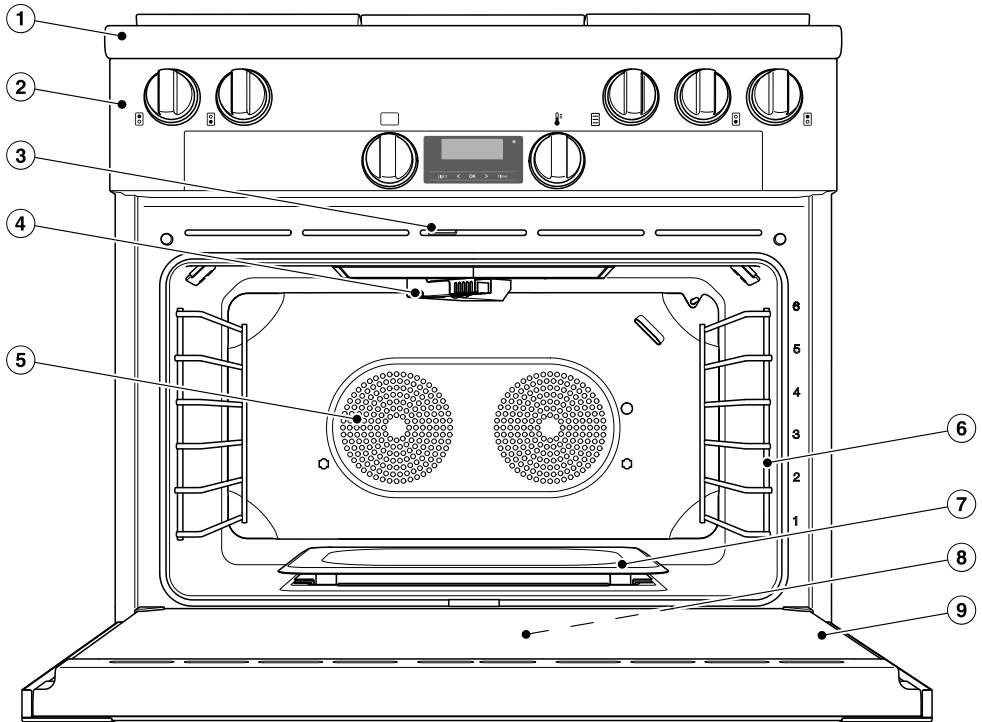

- ① Gas cooktop
- ② Controls
- ③ Door lock for Self Clean
- ④ Browning/Broiling element
- ⑤ Air inlets for the blowers with ring heating elements behind them
- ⑥ Side runners with 6 shelf levels
- ⑦ Oven floor with bottom heat element underneath it
- ⑧ Data plate  
The data plate is located behind the toe-kick panel
- ⑨ Door

# Guide to the range

## Gas cooktop HR 1136-3 AG

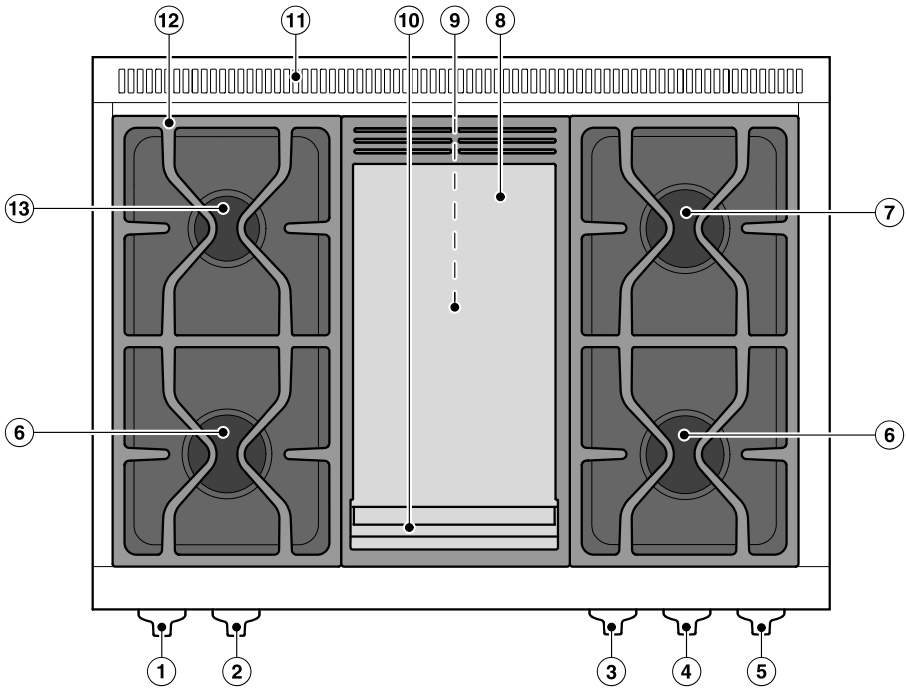

- ① Control knob  
Rear left burner
- ② Control knob  
Front left burner
- ③ Control knob for griddle plate
- ④ Control knob  
Front right burner
- ⑤ Control knob  
Rear right burner
- ⑥ Extra large burner, front
- ⑦ Extra large burner, rear
- ⑧ Griddle plate
- ⑨ Thermostatically controlled ceramic burner
- ⑩ Grease drip tray
- ⑪ Island trim
- ⑫ Grates
- ⑬ Power burner



## Oven HR 1136-3 AG

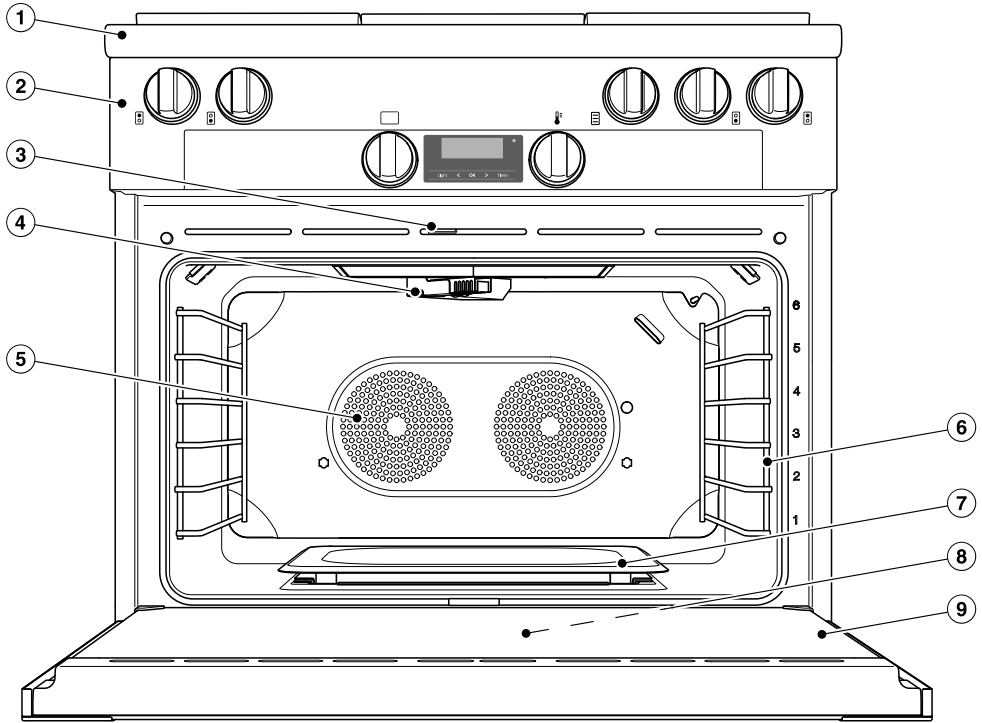

- ① Gas cooktop
- ② Controls
- ③ Door lock for Self Clean
- ④ Browning/Broiling element
- ⑤ Air inlets for the blowers with ring heating elements behind them
- ⑥ Side runners with 6 shelf levels
- ⑦ Oven floor with bottom heat element underneath it
- ⑧ Data plate  
The data plate is located behind the toe-kick panel
- ⑨ Door

# Controls for the range

---

## Controls for gas cooktop HR 1134-3 AG

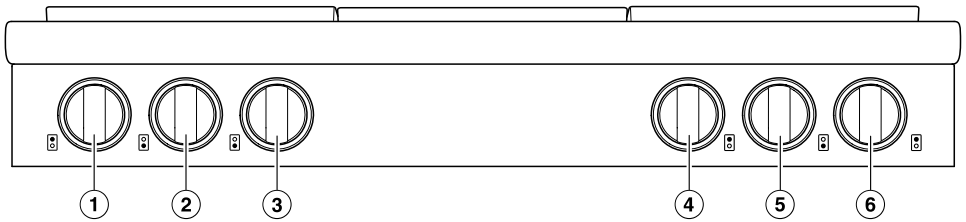

- ① Control knob  
Rear left burner
- ② Control knob  
Front left burner
- ③ Control knob  
Front middle burner
- ④ Control knob  
Rear middle burner
- ⑤ Control knob  
Front right burner
- ⑥ Control knob  
Rear right burner

## Controls for gas cooktops HR 1135-3 AG and HR 1136-3 AG

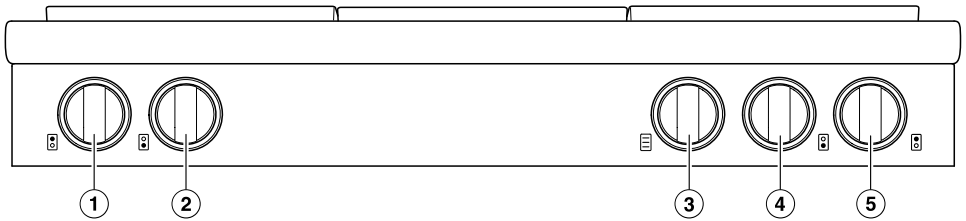

- ① Control knob  
Rear left burner
- ② Control knob  
Front left burner
- ③ Control knob  
HR 1135-3 AG: grill  
HR 1136-3 AG: griddle plate
- ④ Control knob  
Front right burner
- ⑤ Control knob  
Rear right burner

# Controls for the range

## Control knobs for normal and power burners

| Label         | Description   |
|---------------|---|
| <i>Off</i>    | Gas supply off: burner off  |
| <i>High</i>   | Strongest flame setting:<br>Maximum power of upper and lower flame rings            |
| <i>Simmer</i> | Weakest flame setting:<br>Upper flame ring off<br>Minimum power of lower flame ring |

## Control knob for grill

The range HR 1135-3 AG has a grill. The grill is heated by means of a thermostatically controlled ceramic burner.

| Label       | Description               |
|-------------|---------------------------|
| <i>Off</i>  | Gas supply off: grill off |
| <i>High</i> | Highest power level       |
| <i>Low</i>  | Lowest power level        |

## Control knob for griddle plate

The range HR 1136-3 AG has a griddle plate. The griddle plate is heated by means of a thermostatically controlled ceramic burner.

| Label       | Description                       |
|-------------|-----------------------------------|
| <i>Off</i>  | Gas supply off: griddle plate off |
| <i>Low</i>  | Lowest power level                |
| •*          | Medium power level                |
| <i>High</i> | Highest power level               |

\* The symbol without a label indicates a medium power level.

The control knob for each burner is used to ignite the burner and regulate the strength of the flame. The burners can be variably adjusted between the lowest and highest flame settings.

# Controls for the range

---

## Oven controls

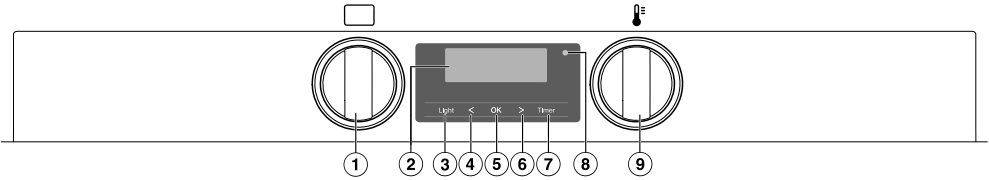

- ① Mode selector  
For selecting operating modes
- ② Clock/timer  
For displaying the time of day and settings
- ③ *Light* sensor button  
For switching the oven interior lighting on and off
- ④ < sensor button  
For changing times and settings
- ⑤ *OK* sensor button  
For accessing functions and saving settings
- ⑥ > sensor button  
For changing times and settings
- ⑦ *Timer* sensor button  
To activate or deactivate a timer
- ⑧ Optical interface  
(for Miele Service only)
- ⑨ Temperature selector  
For setting the temperature

# Controls for the range

## Temperature selector

Use the temperature selector to select the temperature for the cooking processes.

It can be turned clockwise until a resistance is felt and then turned back again to the *Off* position.

The temperature settings are printed on the temperature selector.

## Mode selector

The mode selector is used to select operating modes.

It can be turned clockwise until a resistance is felt and then turned back again to the *Off* position.

The operating modes are printed on the mode selector.

## Operating modes

Bake  (Bake)

Maxi Broil  (Broil)

Self clean  (Clean)

Convection Broil  (Conv Broil)

Convection Bake  (Conv Bake)

( ) alternative mode selector labels in brackets

## Clock/timer

The clock/timer is operated via the **display** with the **sensor buttons**.

## Display

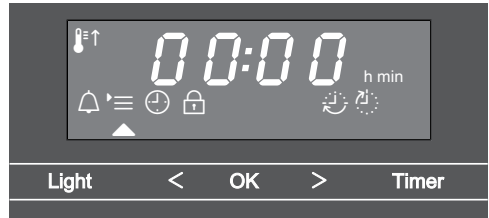







The display shows the time of day or your settings.

Please refer to “Using the oven – Operating the clock/timer” for more information.

## Symbols in the display

Depending on the position of the mode selector and/or which button is pressed, the following symbols will appear:

| Symbol/function   |                             | ○              |
|---|-----------------------------|----------------|
|    | Timer                       | Any            |
|    | Temperature indicator light | Operating mode |
|    | Cooking duration            |                |
|  | End of cooking duration     |                |
|  | Settings <i>P</i>           | <i>Off</i>     |
|  | Time                        |                |
|  | System lock                 |                |

○ Mode selector position

You can only set or change a function if the mode selector is in the corresponding position.

# Controls for the range

---

## Sensor buttons

The range has the following touch-sensitive sensor buttons: *Light*, *<*, *OK*, *>*, and *Timer*. Every touch on the sensor buttons is confirmed by a keypad tone.

The keypad tone can be switched off by changing setting *P 4* to status *5 1* (see “Using the oven – Operating the clock/timer”).

## Temperature indicator light

The temperature indicator light  lights up when the oven is heating.

As soon as the selected temperature is reached, the oven heating switches off and the temperature indicator light goes out.

The temperature control unit ensures that the oven heating and the temperature indicator light switch back on if the oven temperature falls below the level set.

The models described in these operating instructions can be found at the end.

## Data plate

The data plate is located behind the toe kick panel. The toe kick panel is attached to the toe kick of the Range by magnets so it can be removed and put back again easily.

There you can find the model number, serial number and the connection data (voltage/frequency/maximum rated load) for your Range.

Have this information available if you need to contact Miele so that any issues can be rectified as quickly as possible.

## Scope of delivery

- Installation instructions for the range
- Operating instructions for the range, for using the cooktop and oven functions
- Anti-tip device including screws for securing the range
- Various accessories

## Standard and optional accessories

Features will vary depending on model.

The side runners, universal tray, and wire rack (or “rack” for short) are supplied as standard with the oven.

Depending on the model, your oven may also come supplied with some of the accessories listed here.

All the accessories listed as well as the cleaning and care products are designed for Miele Ranges.

These can be ordered from the Miele web store, Miele Customer Service, or from your Miele dealer.

When ordering, please quote the model number of your range and the reference number of the accessories required.

### Side racks

Side racks for accessories are installed on either side of the oven compartment for shelf levels .

The shelf level numbers are indicated on the front of the oven frame.

Each level consists of a rail on which you can place the wire rack, for example.

You can remove the side racks (see “Cleaning and care of the oven – Side rack removal”).

# Features

## Universal tray and Wire Rack with anti-tip safety notches

Universal tray HUBB 30-1:

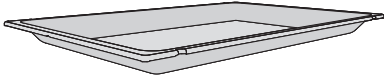

Wire Rack HBBR 36-2:

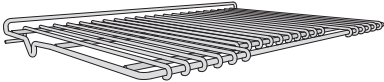

Safety notches are located on the short edges of the Wire Rack. These prevent the Wire Rack from being fully pulled out of the side racks when it only needs to be pulled partially out.

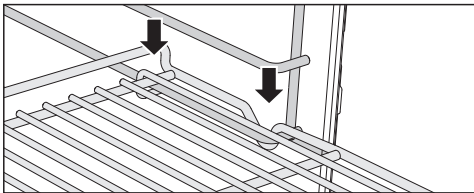

Always slide the Wire Rack into the rails of the side racks with the catches facing down.

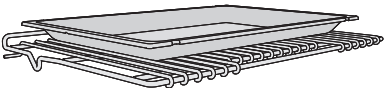

**Tip:** When using the universal tray, place it directly on the Wire Rack.

## FlexiClips with Wire Rack HFCBBR 36-3

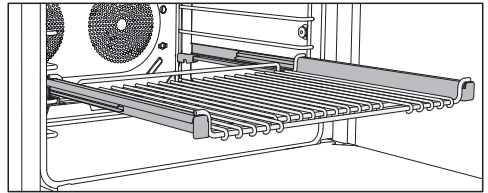

The FlexiClips with Wire Rack are mounted on the side racks and can be pulled completely out of the oven. This allows you to see the food easily.

The FlexiClips with Wire Rack are pushed onto the rails of a level and then locked into place.

The FlexiClips can support a maximum load of 33 lb (15 kg).

The FlexiClips with Wire Rack can be mounted on any shelf level.

## Installing and removing the FlexiClips with Wire Rack

 Danger of injury caused by hot surfaces.

The oven gets hot during operation. You could burn yourself on the heater elements, oven compartment, or accessories.

Allow the heating elements, oven compartment, and the accessories to cool down before installing or removing the FlexiClips with Wire Rack.

When installing or removing the FlexiClips, **do not** extend them.

- Hold the FlexiClips with Wire Rack with both hands and position them in front of the desired level.



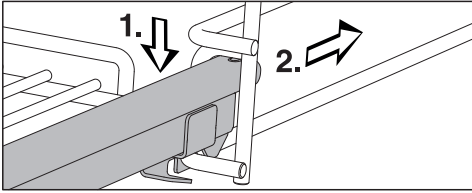

- Insert the FlexiClips with Wire Rack onto the level (1.) and slide them along the struts of the level (2.) until they click into place.

If the FlexiClips are difficult to pull out after installing, you may need to pull firmly on them once to release them.

**Tip:** When using the universal tray, place it directly on the FlexiClips with Wire Rack.

To remove the FlexiClips with Wire Rack, proceed as follows:

- Push the FlexiClips with Wire Rack in all the way.

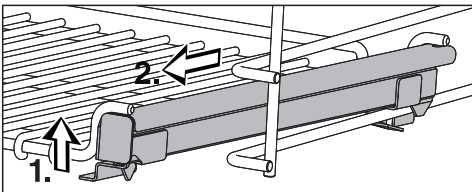

- Lift the front of the FlexiClips with Wire Rack on both sides (1.) and pull them out of the level (2.).

## Temperature selector with °C scale

The range is delivered with a temperature selector with °F scale. The temperature selector with °C scale is available as an optional accessory. Please quote the model designation of the range when ordering.

## Replacing the temperature selector

Do not operate the range without a temperature selector installed.

- Turn the temperature selector to the *Off* position.
- Pull the temperature selector off the range horizontally.
- Install the new temperature selector in the same position by pushing it onto the range.

## Round baking pans



The **solid round baking pan HBF 27-1** is suitable for cooking pizzas, flat cakes, sweet and savory tarts, baked desserts, flat bread, and can also be used for frozen cakes.

The **perforated round baking pan HBFP 27-1** has been specially developed for baked goods made from fresh yeast dough, and for baking bread and rolls. The tiny perforations assist in browning the underside of baked goods. They can also be used for dehydrating or drying food.

The enameled surface of both baking pans has been treated with PerfectClean.

- Insert the wire rack and place the round baking pan on the rack.

## Features

---

### Perforated Gourmet Baking Tray HBBL 71

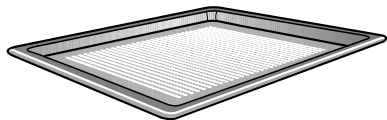

The perforated Gourmet Baking Tray has been specially developed for preparing baked goods made from fresh yeast doughs.

The tiny perforations assist in browning the underside of baked goods.

The Gourmet Baking Tray can also be used for dehydrating or drying food.

The enameled surface has been treated with PerfectClean.

The **round perforated baking tray HBFP 27-1** can be used for these purposes.

- Insert the wire rack and place the perforated gourmet baking tray on the wire rack.

### Broiling and roasting insert HGBB 30-1

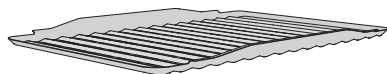

The broiling and roasting insert fits in the universal tray.

The tray will collect meat juices and stop them from burning so that they can be used for making gravy and sauces.

The enameled surface has been treated with PerfectClean.

### HUB Gourmet Casserole Dishes HBD Gourmet Casserole Dish lids

Miele Gourmet Casserole Dishes can be placed directly on the wire rack. The surface of the casserole dishes has a non-stick coating.

Gourmet Casserole Dishes are available in different depths. The width and the height are the same.

Suitable lids are available separately. Please quote the model designation when ordering.

**Depth:**  
**8 1/2" (22 cm)**

HUB 62-22\*



HBD 60-22

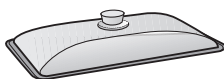

**Depth:**  
**13 3/4" (35 cm)**

HUB 62-35\*

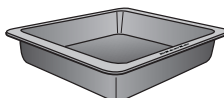

HBD 60-35

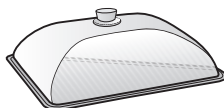

\* Suitable for use on induction cooktops

### Accessories for cleaning and care

- Opener  
The opener is used for removing the cover from the oven lighting.

## Gas cooktop safety features

### Automatic re-ignition

Your gas cooktop features automatic re-ignition. If a gas flame is extinguished, e.g., by food boiling over or by a draft, the flame automatically re-ignites.

### Oven safety features

- **System lock**  for the oven (see “Using the oven – Operating the clock/timer”)

- **Cooling fan**

The cooling fan will come on automatically when a cooking program is started. It ensures that the hot air in the oven compartment is mixed with cool ambient air and thus cooled before it is expelled via the gap between the door and the control panel.

The cooling fan will continue to run for a while after the oven has been turned off to prevent any humidity building up in the oven, on the control panel, or in the cabinet carcass.

The cooling fan will switch itself off automatically after a certain period of time.

- **Safety shut-off**

This safety shut-off is activated automatically if the oven has been operating for an unusually long period of time. The period of time will depend on the particular operating mode being used.

- **Ventilated door**

The oven door is made of glass panes that have a heat-reflective coating on part of their surface. When the oven is operating, air is passed through the door to keep the outer pane cool.

You can remove the door for cleaning purposes (see “Cleaning and care of the oven”).

- **Door locking** for Self Clean  
At the beginning of a Self Clean program, the door will lock for safety reasons. The door will only unlock when the temperature in the oven compartment has dropped to below 535°F (280°C).

### PerfectClean treated surfaces

PerfectClean surfaces have very good non-stick properties making them exceptionally easy to clean.

Food can be easily removed from these surfaces. Soiling from baking and roasting can also be easily removed from these surfaces.

Food can be sliced or cut up on PerfectClean surfaces.

However, do not use ceramic knives as these will scratch the PerfectClean surface.

Surfaces treated with PerfectClean enamel can be cleaned as you would clean glass.

Read the instructions in “Cleaning and care” so that the benefits of the non-stick properties and easy cleaning are retained.

PerfectClean treated surfaces:

- Universal tray
- Baking tray
- Broiling and roasting insert
- Perforated Gourmet Baking Tray
- Round baking pan
- Round perforated baking pan

# Features

---

## **Self-Clean-ready accessories**

See “Cleaning and care of the oven” for more information.

The following accessories can be left in the oven compartment during the Self Clean program:

- Side runners
- FlexiClips with Wire Rack
- Wire rack

## Before using for the first time

 Danger of injury caused by hot surfaces.  
The range gets hot during operation.  
For safety reasons, only use the range when it has been fully installed.

The time of day can only be changed when the mode selector is at *Off*.

- Set the time of day.

## Setting the time of day for the first time

The time of day is shown in 12-hour clock format.

After connecting the range to the electrical supply *12:00* will appear in the display and the triangle ▲ will flash under .



- Use < or > to set the time of day.
- Confirm with *OK*.

The time of day is now saved.

The time of day can be displayed in 24-hour format by setting *P 4* in the settings menu to status *24h* (see “Using the oven – Operating the clock/timer”).

The time of day is saved for approx. 150 hours in the event of a power failure. If the power is restored within this period, the current time will be displayed again. If the power supply is interrupted for longer, the time of day must be reset.

The time of day display (*P 1*) is switched off by default (see “Using the oven – Operating the clock/timer”). The display appears dark if the oven is switched off. The time of day continues to run in the background.

## Before first use

---

### Cleaning the cooktop before heating it up for the first time

The metal components have a protective coating. The cooktop may have a slight odor and give off vapor when heated up for the first time.

Any odors or vapors given off do not indicate a faulty connection or appliance and they are not hazardous to health.

- Remove any adhesive labels or protective films from the cooktop.
- Before heating the cooktop up, wipe with a damp cloth to remove any dust or bits of packaging and then dry the surface.
- Clean all removable parts of the burners with a solution of warm water and a little liquid dish soap applied with a soft sponge. Dry all parts thoroughly after cleaning and then reassemble the burners (see “Gas cooktop cleaning and care”).
- Remove the grill and clean it with a soft sponge, warm water, and a small amount of liquid dish soap. Then dry the grill.

### Seasoning the griddle plate

You need to season the griddle plate before you can cook food on it. This prevents food from sticking to it and protects the surface from moisture.

Ensure that the kitchen is well ventilated while the appliance is being heated up for the first time. Close doors to other rooms to prevent the odor spreading throughout the house.

- Set the griddle plate to *High* for 30 minutes.
- Switch off the griddle plate after 30 minutes.
- Let the griddle plate cool down.

The griddle plate will be permanently discolored after heating up. The discoloration can increase over time. This will not affect functionality in any way.

- Pour 1 teaspoon of vegetable oil that can be heated to a high temperature in the middle of the cooled griddle plate.
- Distribute the oil with a paper towel. Do not oil the corners.

Do not use too much oil. Excess oil leaves behind a rubbery substance that needs to be removed.

- Remove excess oil with a paper towel.
- Set the griddle plate to *High* until the oil starts to smoke.
- Switch off the griddle plate.
- When the griddle plate has cooled down sufficiently that it can be touched, remove excess oil.
- Repeat the process once the griddle plate has cooled down completely.

## Heating the oven for the first time

New ovens may have a slight odor when they are heated up for the first time. Heating up the oven for at least an hour with nothing in it will eliminate the odor.

Ensure that the kitchen is well ventilated while the appliance is being heated up for the first time. Close doors to other rooms to prevent the odor spreading throughout the house.

- Remove any adhesive labels or protective films from the ovens and accessories.
- Before heating the oven up, wipe the interior with a damp cloth to remove any dust or bits of packaging that may have accumulated in the oven compartment.
- Insert the FlexiClips with Wire Rack into the side racks and place all trays and the Wire Rack in the oven.

### All Gas Range

Risk of injury caused by hot vapors. Hot vapors are emitted above the island trim during Self Clean as well as when cooking food in the oven. You could burn yourself on the hot vapors.

Do not reach above the island trim and keep others away from it when you are using the oven.

### All Gas Range

Hot vapors are emitted above the island trim during Self Clean as well as when cooking food in the oven. The emission of vapors can soil and discolor surfaces above the island trim.

Take precautions to protect sensitive surfaces such as marble, granite, and tiles against soiling and discoloration (surfaces of this nature can be difficult or even impossible to clean).

- Select the Convection Bake  (Conv Bake) operating mode.

The oven lighting and the fan will switch on.

- Set the maximum temperature (500°F).

The ignitor “clicks” and ignites the gas.

- Heat up the oven for at least an hour.
- After heating up, turn the mode selector to *Off*.
- After heating up, turn the temperature selector to *Off*.

## Before first use

---

### Cleaning the oven compartment after heating it up for the first time

 Risk of injury caused by hot surfaces.

The oven gets hot during operation. You could burn yourself on the heating elements, oven compartment, or accessories. Allow the heating elements, oven compartment, and accessories to cool before manual cleaning.

- Take all accessories out of the oven compartment and clean it by hand (see “Cleaning and care of the oven”).
- Clean the oven compartment with warm water and liquid dish soap, applied with a soft sponge or microfiber cloth.
- Dry all surfaces with a soft cloth.

Leave the oven door open until the oven compartment is completely dry.



## Energy-saving tips

- Cook in covered pots and pans if possible. Doing so will prevent unnecessary heat loss.

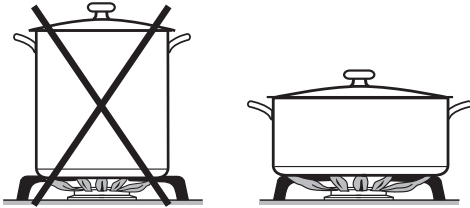



- Wide, shallow pots are preferable to tall, narrow ones. They will heat up faster.
- Cook with as little water as possible.
- Once food has come to a boil or the pan is hot for frying, reduce the heat to a lower power setting.
- Use a pressure cooker to reduce cooking durations.

## Suitable cookware

- Select cookware that fits the size of the burner:  
Large diameter = large burner  
Small diameter = small burner
- Using cookware that is too large can cause the flames to spread out and damage the surrounding countertop or other appliances. Choosing the right cookware size improves efficiency.
- Any cookware that has a diameter smaller than the burner grate or which does not rest in a stable position on the grate (without wobbling) is dangerous and should not be used.

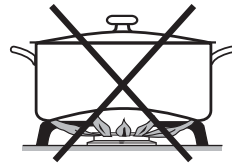
- Unlike cookware that is used on an electric cooktop, the bottom of cookware used on a gas cooktop does not have to be flat to deliver effective cooking performance.
- When purchasing pots and pans, keep in mind that the diameter indicated is typically the top diameter, not the bottom diameter.
- All heat-resistant cookware is suitable for use.
- Cookware with a thick bottom is preferable, as it distributes heat more evenly. Cookware with a thin bottom may cause food to overheat in certain spots. To avoid this, stir the food frequently.
- Always place the cookware on the grates supplied. Do not place cookware directly on the burners.
- Position the cookware on the burner grate so that it cannot tip. There is always a possibility of a slight tilt, despite the proper position.
- Do not use pots or pans that have bottoms with pronounced edges.



 Fire hazard due to overheated food.  
Unattended food can overheat and ignite.  
Do not leave the cooktop unattended whilst it is being used.

# Using the gas cooktop

## Switching on the burner

Do not turn the control knob clockwise past the *Off* position.

When a control knob is activated, a spark is developed automatically on all burners. This is normal and does not indicate a fault.

You may notice a brief re-ignition (1–2 clicks) when turning on the appliance, e.g., because of a draft.

- Push in the control knob for the burner required and turn it counterclockwise to *High*.

The ignitor “clicks” and ignites the gas.

- If the burner fails to ignite, turn the control knob to the *Off* position. Aerate the room or wait at least 1 minute before trying again.
- If the burner does not ignite the second time, turn the control knob back to *Off* and see “Frequently asked questions”.

## Switching on during a power failure

 If there has been a power failure, the automatic re-ignition feature will not work properly.

Operate the cooktop only under supervision. If the burner has not ignited or the flame goes out, turn the control knob to *Off*.

## Normal and power burners

In case of a power failure, the flame can be ignited manually.

- Push in the control knob and turn it counterclockwise to *High*.
- Light the emerging gas/air mixture with a match.

## Grill

 Danger of injury caused by manually igniting the burner during a power failure!  
Never operate the grill during a power failure.

- Turn the grill control knob to *Off*.

## Griddle plate

 Danger of injury caused by manually igniting the burner during a power failure!  
Never operate the griddle plate during a power failure.

- Turn the control knob for the griddle plate to *Off*.

# Using the gas cooktop

## Adjusting the flame

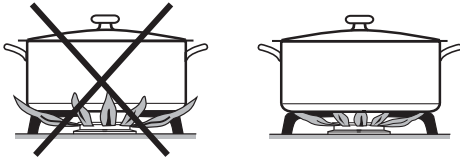

The burners can be variably adjusted between the lowest and highest flame settings.

As the outer part of the flame is much hotter than the center, the tips of the flames should stay beneath the pan base. Flame tips which extend beyond the sides of the pan merely warm up the air in the room and can damage pan handles and increase the risk of injury.

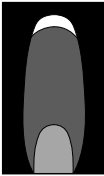

- Adjust the flame so that it does not spread out beyond the sides of the pan.

## Appearance of the gas flames

|   |   |
|---|---|
|  | <b>Yellow flames</b><br>Contact<br>Customer<br>Service.   |
|  | <b>Yellow tips on the outer cone</b><br>Normal for LP gas   |
|  | <b>Pale blue flames</b><br>possibly with<br>yellow tips on the<br>inner cone<br>Normal for natural<br>gas |

## Switching off the burner

Do not turn the control knob clockwise past the *Off* position.

- Turn the control knob clockwise to the *Off* position.

This stops the flow of gas and the flame goes out.

# Using the gas cooktop

---

## Using the grill

### Switching on the grill

Always observe USDA food safety guidelines.

- Push in the grill control knob and turn it counterclockwise to *High* until the burner ignites.
- If the burner fails to ignite, turn the control knob to the *Off* position. Aerate the room or wait at least 1 minute before trying again.
- If the burner does not ignite the second time, turn the control knob back to *Off* and see “Frequently asked questions”.
- Preheat the grill for approx. 10 minutes.
- Set the power level you want.

Do not use cooking utensils on the grill.

### Tips for grilling



**Risk of fire!**

Do not leave the appliance unattended while cooking.

- Always preheat the grill for 10 minutes before use. Select the setting that you are going to cook with.
- Pat wet food dry with a paper towel to avoid spitting when grilling.
- To prevent meat drying out, do not season with salt until after it has been grilled.

- Select lean meat or cut the fat off prior to grilling. Drops of fat can ignite.
- If drops of fat ignite, use long barbecue tongs to immediately move the food to another area of the grill or remove it completely.
- Remove the skin from chicken breasts and thighs to minimize flare-ups.
- Cover the food with the marinade halfway through grilling.
- Leave the grill on for approx. 10 minutes after you have finished grilling. This will make the grill easier to clean once it has cooled down.

The grill is heated by means of a ceramic burner which transfers intense heat to the food. Searing helps to keep juices in the meat. The temperature of the grill can be variably adjusted between the lowest and highest flame settings.

The grill and griddle plate will be switched off as soon as you start the Self Clean program on the oven.

The grill and griddle plate cannot be turned on during Self Clean.

## Using the griddle plate

During heating, an LP gas griddle plate can emit a buzzing or growling sound. This is not an error.

## Switching on the griddle plate

Always observe USDA food safety guidelines.

- Push in the griddle plate control knob and turn it counterclockwise to *Low* until the burner ignites.
- If the burner fails to ignite, turn the control knob to the *Off* position. Aerate the room or wait at least 1 minute before trying again.
- If the burner does not ignite the second time, turn the control knob back to *Off* and see “Frequently asked questions”.
- Preheat the griddle plate for approx. 20 minutes.
- Set the power level you want.

## Tips for griddling

Clean the griddle plate before every use with a damp sponge to remove dust particles or other residues.

- Always preheat the griddle plate for 20 minutes before use. Select the setting that you are going to cook with.
- Pat wet food dry with a paper towel to avoid spitting.
- To prevent meat drying out, do not season with salt until after it has been cooked.
- Very little fat is required for cooking on the griddle plate and no fat is required for marinated food. If you are using fat, do not put it onto the griddle plate until the griddle plate is hot.
- Use only fats and oils that can withstand high temperatures.
- We recommend that you marinate the food to be cooked. This will improve the flavor of the food.

## Using the gas cooktop

The griddle plate is equipped with a thermostat that maintains an even temperature.

The griddle plate must be seasoned first to prevent food from sticking to it (see “Before using for the first time – Seasoning the griddle plate”). The temperature of the griddle plate can be variably adjusted between the lowest and highest flame settings.

The grill and griddle plate will be switched off as soon as you start the Self Clean program on the oven.

The grill and griddle plate cannot be turned on during Self Clean.

### Griddle plate settings

| Power level     | Food            |
|-----------------|-----------------|
| <i>Low</i>      | Simmering sauce |
|                 | Keeping warm    |
| •*              | Eggs            |
|                 | Bacon           |
|                 | French toast    |
| •* <i>-High</i> | Fish            |
|                 | Pancakes        |
|                 | Sausages        |
|                 | Hash browns     |
|                 | Vegetables      |
| <i>High</i>     | Burgers         |
|                 | Steaks          |
|                 | Stir fry        |

\* The symbol without a label indicates a medium power level.

**⚠ All Gas Range**

Risk of injury caused by hot vapors. Hot vapors are emitted above the island trim during Self Clean as well as when cooking food in the oven. You could burn yourself on the hot vapors.







Do not reach above the island trim and keep others away from it when you are using the oven.

**⚠ All Gas Range**

Hot vapors are emitted above the island trim during Self Clean as well as when cooking food in the oven. The emission of vapors can soil and discolor surfaces above the island trim.

Take precautions to protect sensitive surfaces such as marble, granite, and tiles against soiling and discoloration (surfaces of this nature can be difficult or even impossible to clean).

## Overview of operating modes

| Operating modes   | Range   |
|---|---|
| Bake  (Bake)                   | 150–500°F<br>(65–260°C)   |
| Maxi Broil  (Broil)            |  |
| Self clean  (Clean)            | –   |
| Convection Broil  (Conv Broil) | 150–500°F<br>(65–260°C)   |
| Convection Bake  (Conv Bake)   | 150–500 °F<br>(65–260 °C)   |



( ) alternative mode selector labels in brackets

# Using the oven

---

## Energy-saving tips

### Cooking programs

- Remove all accessories from the oven that are not required for a cooking process.
- If a temperature range is given, it is best to select the lower temperature and check the food after the shortest cooking time given.
- Try not to open the door when cooking.
- It is best to use dark bakeware and cooking containers with a matte finish made of non-reflective materials (enameled steel, heat-resistant glass, non-stick coated cast aluminum). Shiny materials such as stainless steel or aluminum reflect the heat and therefore can give a more uneven result. Do not cover the oven floor or the Wire Rack with heat-reflecting aluminum foil.
- Monitor cooking durations to avoid wasting energy when cooking. Set the cooking duration, or use a food probe if you have one.
- The Convection Bake  (Conv Bake) operating mode can be used for cooking many types of food. Heat is circulated around the oven compartment immediately. It also enables you to cook on multiple shelf levels at the same time.
- Convection Broil  (Conv Broil) is the best operating mode for broiled dishes. Lower temperatures can be used than with other broil modes that use the maximum temperature setting.
- Whenever possible you should cook several dishes at the same time. Place them next to each other in the oven or on different shelf levels.
- Dishes which you are unable to prepare at the same time should, if possible, be cooked one after the other in order to make use of existing heat in the oven.



## Residual heat utilization

- The temperature in cooking programs using temperatures above 285°F (140°C) which take longer than 30 minutes to cook can be turned down to the lowest possible temperature about 5 minutes before the end of cooking. The residual heat in the oven is sufficient for cooking the food until it is done. However, do not turn the oven off (see “IMPORTANT SAFETY INSTRUCTIONS”).
- It is best to start the Self Clean program immediately after a cooking program. The residual heat in the oven will help reduce the amount of energy required.

## Energy-saving mode

The oven will turn itself off automatically to save energy if a program is not being run and no controls have been operated. The time of day will appear on the display or the display will remain dark (see “Operating the clock/timer”).

## Simple operation

- Place the food in the oven.
- Select the required operating mode with the mode selector.

The oven lighting and the fan will switch on.

- Select the temperature with the temperature selector.

The ignitor “clicks” and ignites the gas.

After the cooking program:

- Turn the mode selector to *Off* and the temperature selector to *Off*.
- Take the food out of the oven.

## Preheating

It is always necessary to preheat the oven.

Select the required operating mode and the temperature. Preheat the oven for approx. 15 minutes with the door closed. As soon as the oven has reached the required temperature, you can place the food inside.

# Using the oven

## Operating the clock/timer

### Switching cooking programs on and off automatically

Cooking programs can be switched on or off automatically.

To do this, set a cooking duration or a cooking duration and a finish time after selecting the operating mode and temperature.

The maximum duration which can be set for a cooking program is 11 hours and 59 minutes.

It is recommended to switch on and off automatically when roasting.

If used for baking, do not delay the start for too long. Otherwise the cake mixture or dough will dry out, and the raising agents will lose their effectiveness.

### Setting the cooking duration

Example: a cake needs to bake for 1 hour and 5 minutes.

- Place the food in the oven.
- Select the required operating mode and the temperature.

The oven heating, lighting, and cooling fan will turn on.

- Select *OK*.
- If necessary, use < or > to move the triangle ▲ until it appears under ⌚.
- Confirm with *OK*.

00:00 h will appear in the display with the triangle ▲ flashing under ⌚.



- Use < or > to set the cooking time (01:05).
- Confirm with *OK*.

The cooking duration is now saved and will count down in minutes until the last minute, which will count down in seconds.

The ⌚ symbol indicates that a cooking duration has been set.

### Setting a cooking duration and a finish time

Example: the current time of day is 11:15 am; a roast with a cooking duration of 90 minutes needs to be ready at 1:30 pm.

- Place the food in the oven.
- Select the required operating mode and the temperature.

The oven heating, lighting, and cooling fan will turn on.

### First set the cooking duration:

- Select *OK*.
- If necessary, use < or > to move the triangle ▲ until it appears under ⌚.
- Confirm with *OK*.

00:00 h will appear in the display with the triangle ▲ flashing under ⌚.

- Use < or > to set the cooking time (01:30).
- Confirm with *OK*.

The cooking duration  is saved and then counts down in minutes:



**Then set the finish time:**

- Move the triangle  with < or > until it appears under .

-- appears:



- Confirm with *OK*.

12:45 (current time of day + cooking duration = 11:15 + 1:30) appears in the display:



- Use < or > to set the end of the cooking time (13:30).
- Confirm with *OK*.

The finish time  is now saved:



The oven heating, lighting and cooling fan will switch off.

As soon as the start time (13:30 - 1:30 = 12:00) has been reached, the oven heating, lighting and cooling fan will switch on.



**At the end of the cooking duration:**

- 0:00 appears.
-  flashes.
- The oven heating switches off automatically.
- The cooling fan continues to run.
- An audible signal will sound if the audible signal is switched on.

- Turn the mode selector to *Off*.
- Turn the temperature selector to *Off*.
- Take the food out of the oven.

If the dish is not cooked to your satisfaction you can prolong the cooking duration by entering a new duration.

**Changing the cooking duration**

- Select *OK*.
- If necessary, use < or > to move the triangle  until it appears under .

The remaining cooking duration will appear in the display.

- Confirm with *OK*.
- Change the cooking time with < or >.
- Confirm with *OK*.

The changed cooking duration is now saved.

# Using the oven

## Deleting a cooking duration

- Select *OK*.
- If necessary, use < or > to move the triangle ▲ until it appears under .
- Confirm with *OK*.

The triangle ▲ flashes under .

- Use < to set the cooking time to *00:00*.
- Confirm with *OK*.

The cooking duration and any finish time set are deleted.

- Select *OK*.

The actual temperature will appear. The oven heating remains switched on.

If you want to end the cooking program:

- Turn the mode selector to *Off*.
- Turn the temperature selector to *Off*.
- Take the food out of the oven.

If the mode selector is turned to the *Off* position, the settings for cooking duration and end of cooking duration will be deleted.

## Deleting a finish time

- Select *OK*.
- If necessary, use < or > to move the triangle ▲ until it appears under .
- Confirm with *OK*.

The triangle ▲ flashes under .

- Use < or > to set the end of the cooking time to *-:-*.
- Confirm with *OK*.

The finish time is deleted.

## Changing the time of day

The time of day can only be changed when the mode selector is at *Off*.

- Turn the mode selector to *Off*.
- Select *OK*.
- Move the triangle ▲ with < or > until it appears under .
- Confirm with *OK*.

The triangle ▲ flashes under .

- Use < or > to set the time of day.
- Confirm with *OK*.

The time of day is now saved.

The time of day is saved for approx. 150 hours in the event of a power failure. If the power is restored within this period, the current time will be displayed again.

If the power supply is interrupted for longer, the time of day must be reset.

## Changing factory default settings

Default settings are set in the oven controls at the factory (see “Settings overview”).

A setting can be changed by altering its status.

The settings can only be changed when the mode selector is at *Off*.

- Select *OK*.
- If necessary, use < or > to move the triangle ▲ until it appears under '≡.



- Confirm with *OK*.

*P 1* appears:

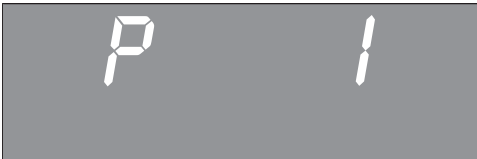

- If you want to change another setting, select the appropriate number with < or >.
- Confirm with *OK*.

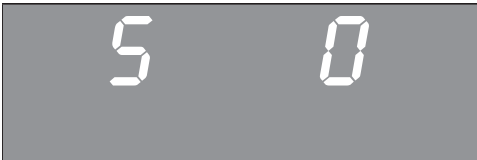

The setting is selected and the current status appears, e.g., *5 0*.

To change the status:

- Set the desired status using < or >.

- Confirm with *OK*.

The status is saved and the setting appears again.

- To change additional settings, proceed in the same way.
- If you do not want to change any further settings, select '≡.

The settings will remain in the memory in the event of a power failure.

# Using the oven

## Settings overview

| Setting                                    | Status   |
|--|--|
| <i>P 1</i><br><b>Time of day display</b>   | <i>S 0</i> * The time of day display is <b>deactivated</b> .<br>The display appears dark if the oven is switched off.<br>The time of day continues to run in the background.<br><br>If you have selected the status <i>S 0</i> , the oven has to be turned on before you can use it. The same applies if you set a timer with the <i>Timer</i> sensor button or want to use the <i>Light</i> sensor button to switch on the oven interior lighting.<br><br>The oven will also switch off automatically if you do not make any settings within a certain amount of time (approx. 30 minutes).<br><br><i>S 1</i> The time of day display is <b>switched on</b> .<br>The time of day is visible in the display. |
| <i>P 2</i><br><b>Audible signal volume</b> | <i>S 0</i> The audible signal is <b>switched off</b> .<br><i>S 1</i> to <i>S 21</i> * The audible signal is <b>switched on</b> .<br>You can adjust the volume. When you select a status you will hear the corresponding audible signal.  |
| <i>P 3</i><br><b>Keypad tone</b>           | <i>S 0</i> The keypad tone is <b>turned off</b> .<br><i>S 1</i> * The keypad tone is <b>turned on</b> .  |
| <i>P 4</i><br><b>Time of day format</b>    | <i>12h</i> * The time of day is shown in the <b>12-hour format</b> .<br>If you change the clock after 1:00 pm from a 12-hour clock to a 24-hour clock you will need to update the hour accordingly.<br><br><i>24h</i> The time of day is shown in the <b>24-hour format</b> .  |

\* Factory default

## Using the oven

| Setting                           | Status   |
|-----------------------------------|--|
| P 5<br><b>Display brightness</b>  | 5 1 to 5 7,<br>5 4 *<br>5 1: minimum brightness<br>5 7: maximum brightness   |
| P 6<br><b>Lighting</b>            | 5 0 * The oven interior lighting is <b>on for 15 seconds</b> and then turns off automatically.<br>5 1 The oven interior lighting is <b>permanently turned on</b> .   |
| P 7<br><b>Temperature control</b> | 0 *<br>-3 to 3<br>You can change the temperature in increments in all operating modes so that it is higher or lower in the oven compartment than displayed.<br>The higher the setting, the higher the oven temperature.  |
| P 8<br><b>Demo mode</b>           | 5 0 * Select 5 0 and press OK for approx. 4 seconds. Demo mode is <b>deactivated</b> as soon as - - - - is shown briefly in the display.<br>5 1 Select 5 1 and press OK for approx. 4 seconds. Demo mode is <b>activated</b> as soon as <i>DE5_</i> is shown briefly in the display.<br>The oven can be operated, however the heating elements will not work. Do not activate this setting for domestic use. |

\* Factory default

# Using the oven

## Switching the system lock on and off



The system lock  prevents the oven from being used unintentionally.

The appliance is delivered with the system lock deactivated. The setting for the system lock can be changed by altering its status 5:

- 5 0 = off
- 5 1 = on

The system lock status can only be changed when the mode selector is at *Off*.

## Activating the system lock

- Select *OK*.
- Move the triangle  with < or > until it appears under .



- Confirm with *OK*.

The currently set status 5 0 appears and the triangle  flashes under .



- Use < or > to set the status 5 1.



- Confirm with *OK*.



The system lock is activated.

When the appliance is switched on again, the  symbol will appear in the display to remind you that the system lock has been activated.

The system lock will remain activated even after a power failure.

## Deactivating the system lock for a cooking process

- Select an operating mode.

The  and  symbols and the current time of day will appear:



- Touch *OK* until  goes out.



The oven can now be used.

## Deactivating the system lock

- Turn the mode selector to *Off*.
- Touch *OK* until  goes out.
- Select *OK*.

- Move the triangle  with < or > until it appears under .

- Confirm with *OK*.

The currently set status 5 1 appears and the triangle  flashes under .

- Use < or > to select the status 5 0.
- Confirm with *OK*.

The system lock is deactivated.

The  symbol disappears.



## Using the timer

The timer can be used to time any activity in the kitchen, e.g. boiling eggs.



The timer can also be used at the same time as a cooking program if a start and finish time have been set, e.g. a reminder to stir the dish or add seasoning.

A maximum time of 99 minutes and 55 seconds can be set for the timer.

## Setting the timer

Example: you want to boil some eggs and set a timer of 6 minutes and 20 seconds.

- Select the *Timer* sensor button.

00:00 will appear in the display with the triangle  flashing under .

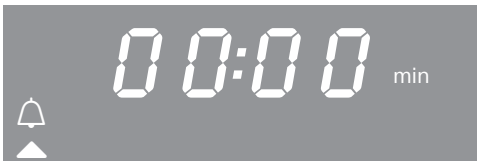

- Use < or > to set the timer as desired.



- Confirm with *OK*.

The timer duration is now saved and will count down in seconds:



The  symbol indicates that the timer has been set.

## When the timer elapses

-  flashes.
- The time will count upwards.
- An audible signal will sound if the audible signal is turned on.

- Select the *Timer* sensor button.

The audible signal will stop and the symbols on the display will go out.

## Changing the timer

- Select the *Timer* sensor button.

The current timer appears.

- Use < or > to change the time set for the timer.
- Confirm with *OK*.

The modified timer duration is saved and will count down in seconds.

## Deleting the timer

- Select the *Timer* sensor button.
- Use < to reduce the timer time to 00:00.
- Confirm with *OK*.

The timer is deleted.

# Baking

Handling and cooking food correctly is essential for maintaining good health.

Cakes, pizzas, and French fries should be cooked until golden, not dark brown.

Always observe USDA/CFIA food safety guidelines.

## Tips for baking

- Set a cooking duration. If used for baking, do not delay the start for too long. Otherwise the cake mixture or dough will dry out, and the raising agents will lose their effectiveness.
- Generally speaking, you can use wire racks, baking trays, universal trays, and any type of bakeware made of heat-resistant material.
- Avoid using bright, thin-walled pans made from a shiny material as they give an uneven or poor browning result. In certain unfavorable conditions, the food will not cook properly.
- Place cakes in rectangular bakeware on the wire rack with the longer side across the width of the oven for optimum heat distribution and even results.
- Always place bakeware on the wire rack.
- When baking cakes with fruit toppings or deep cakes, place the pan on the universal tray to catch any spillages.

## Using parchment paper

Miele accessories, e.g., the universal tray, are treated with PerfectClean (see “Features”). Surfaces treated with PerfectClean generally do not need to be greased or covered with parchment paper.

- Use parchment paper when baking lye mixtures (e.g., pretzels) because the sodium hydroxide can damage the PerfectClean treated surface.
- Use parchment paper when baking sponge cake, meringue, macaroons, or similar items. These are more likely to stick due to their high egg white content.
- Use parchment paper when cooking frozen food on the wire rack.

## Selecting the temperature

- As a general rule, select the temperature given in the corresponding recipe.

Choosing a baking temperature higher than those recommended may reduce the cooking time, but will lead to uneven browning and unsatisfactory cooking results.

## Selecting the cooking duration

- Check whether the food is cooked shortly before the end of the specified cooking duration. Stick a wooden skewer into the food.

If it comes out clean without any batter/dough on it, the food is done.

## Notes on the operating modes

A list of all operating modes can be found in “Overview of operating modes”.

### Preheating

It is always necessary to preheat the oven.

Select the required operating mode and the temperature. Preheat the oven for approx. 15 minutes with the door closed. As soon as the oven has reached the required temperature, you can place the food inside.

### Using Convection Bake (Conv Bake)

- 1 shelf: place the food on shelf level 3.
- 2 shelves: place the food on shelf levels 2+4.

**Tip:** If you are cooking on multiple shelf levels at the same time, slide the universal tray in on the lowest level.

### Using Bake (Bake)

Avoid tins made from dark metal, dark enamel, or matte aluminum as they will result in excessive browning and in some cases the food may burn.

- 1 shelf: place the food on shelf level 3.

# Roasting

---

Always observe USDA/CFIA food safety guidelines.

## Tips for roasting

- You can use all dishware made from temperature-resistant materials, e.g., roasting dishes, roasting pans with lid, ovenproof glass dishes, roasting bags, dishes made from earthenware or cast iron, the universal tray, wire rack, and/or anti-splash insert (if available) on top of the universal tray.
- **Preheating** the oven is only required when preparing roast beef and fillets. Preheating is generally not necessary.
- Use a **closed cooking container** for roasting meat, such as a roasting dish. The meat will stay succulent. The oven compartment will also stay cleaner than when roasting on the wire rack. It ensures that enough stock remains for making gravy.
- If you are using a **roasting bag**, follow the instructions on the packaging.
- If you are using the **wire rack** or an **open cooking container** for roasting, you can add a little fat or oil to very lean meat or place a few strips of bacon on the top.
- **Season** the meat and place in the cooking container. Dot with butter or brush with oil or cooking fat. For large lean cuts of meat (4–6 lb/2–3 kg) and fatty poultry, add about 1/2 cup (1/8 liter) of water to the dish.

- Do not add too much liquid during cooking as this will hinder the **browning** process. Browning only occurs towards the end of the cooking duration. Remove the lid about halfway through the cooking duration if you want a more intensive browning result.
- At the end of the program, take the food out of the oven, cover it, and leave to **stand** for about 10 minutes. This helps retain the juices when the meat is sliced.
- For a crisp finish, baste **poultry** 10 minutes before the end of the cooking duration with slightly salted water.

## Selecting the temperature

- As a general rule, select the temperature given in the corresponding recipe.
- For large pieces of meat, do not choose a temperature that is too high. The roasting process will take longer, but the meat will cook through evenly and the skin or crackling will not be too thick.
- When roasting on the Wire Rack, set a temperature approx. 50°F (10°C) lower than for roasting in a covered cooking container.

## Selecting the cooking duration

- Determine the cooking duration by multiplying the thickness of the roast [cm] with the time per cm [min/cm] stated below, depending on the type of meat:
  - beef/venison: 15–18 min/cm
  - pork/veal/lamb: 12–15 min/cm
  - sirloin/fillet: 8–10 min/cm
- Check whether the food is cooked shortly before the end of the specified cooking duration.

## Tips

- For frozen meat, increase the cooking duration by approx. 20 minutes per kg.
- Frozen meat weighing less than approx. 3.3 kg (1.5 kg) does not need to be defrosted before roasting.

## Notes on the operating modes

A list of all operating modes can be found in “Overview of operating modes”.

### Preheating

It is always necessary to preheat the oven.

Select the required operating mode and the temperature. Preheat the oven for approx. 15 minutes with the door closed. As soon as the oven has reached the required temperature, you can place the food inside.

Use the Bake  (Bake) operating mode towards the end of the cooking duration to brown the base of the food.

### Using Convection Bake (Conv Bake)

This operating mode is suitable for roasting meat, fish, and poultry that needs to be well browned, as well as roast beef and fillet.

- Place the food on shelf level 3.
- Place large items, e.g., a turkey, on level 1 or 2.

### Using Bake (Bake)

- 1 shelf: place the food on shelf level 3.
- Place large items, e.g., a turkey, on level 1 or 2.

# Broiling

 Risk of injury caused by hot surfaces.

If you broil with the door open, the hot air will escape from the oven before it has been cooled by the cooling fan. The control elements will get hot.

Broil with the oven door closed.

Always observe USDA/CFIA food safety guidelines.

## Tips for broiling

- Preheating is necessary when broiling. Preheat the browning/broiling element for approx. 15 minutes with the door closed.
- Quickly rinse meat under cold running water and pat dry. Do not season the meat with salt before broiling, as this will draw out the juices.
- Add a little oil to lean meat if necessary. Do not use other types of fat as they can easily burn and cause smoke.
- Clean fish in the normal way. To enhance the flavor, season with a little salt. You can also drizzle the fish with lemon juice.
- Use the universal tray with the broiling and roasting insert (if present) on top and place the universal tray on the wire rack.

- The tray under the insert will collect the meat juices and stop them from burning so that they can be used for making gravy and sauces. Brush the wire rack or the broiling and roasting insert with oil and then place the food on top. Using the broiling and roasting insert can reduce the amount of smoke produced.

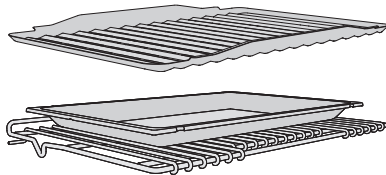

## Selecting the temperature

- As a general rule, select the temperature given in the corresponding recipe.
- For large pieces of meat, do not choose a temperature that is too high. The roasting process will take longer, but the meat will cook through evenly and the skin or crackling will not be too thick.

## Choosing a shelf level

- Select the shelf level depending on the thickness of the food to be cooked.
- Place flat food on shelf level 4 or 5.
- Place thicker food on shelf level 2 or 3.

## Selecting the cooking duration

- Broil thinner cuts of meat/slices of fish for approx. 3–6 minutes per side. Thicker pieces require more time per side.

It is best to broil food of a similar thickness at the same time so that the cooking durations do not vary too much.

- Check whether the food is cooked shortly before the end of the specified cooking duration.

**Tip:** If the surface of a thicker cut of meat is browned but the center is still raw, move the food to a lower level or reduce the temperature and continue broiling. This will stop the surface from becoming too dark.

## Notes on the operating modes

A list of all operating modes can be found in “Overview of operating modes”.

### Using Maxi Broil (Broil)

Use this operating mode to broil flat thin cuts in large quantities and for browning large baked dishes.

The entire browning/broiling element will become red hot to produce the necessary heat.

### Using Convection Broil (Conv Broil)

This operating mode is suitable for broiling thicker food, such as chicken.

It is generally recommended to use a temperature setting of 425°F (220°C) for thinner types of food and 350–400°F (180–200°C) for thicker cuts.

## Further applications

This section provides information on the following applications:

- Defrost
- Dehydrating
- Heating dishware
- Slow Roasting
- Canning
- Frozen food/ready meals

### Defrost

Gentle defrosting of frozen food means that the vitamins and minerals are generally retained.

- Select the Convection Bake  (Conv Bake) operating mode without a temperature setting.

Air is circulated throughout the oven compartment to gently defrost the frozen food.

Always observe USDA/CFIA food safety guidelines.

 Risk of infection from bacteria. Bacteria such as salmonella can cause life-threatening food poisoning.

It is particularly important to observe food hygiene rules when defrosting fish and meat, and in particular when defrosting poultry.

Do not use the liquid produced during defrosting.



Process the food as required as soon as it has been defrosted.

### Tips

- Remove the packaging and place the frozen food on the universal tray or in a suitable bowl or dish.
- Use the universal tray with the wire rack placed on top of it for defrosting poultry. This way the food will not be lying in the defrosted liquid.
- Fish does not need to be fully defrosted before cooking. Defrost until the food has started to thaw. The surface will then be sufficiently thawed to take herbs and seasoning.

### Defrosting durations

The duration needed for defrosting depends on the type and weight of the frozen food:

| Frozen food  |  [oz/g] |  [min] |
|--------------|--|--|
| Chicken      | 28/800   | 90–120   |
| Meat         | 17.5/500   | 60–90  |
|              | 35/1000  | 90–120   |
| Sausage      | 17.5/500   | 30–50  |
| Fish         | 35/1000  | 60–90  |
| Strawberries | 10.5/300   | 30–40  |
| Pound cake   | 17.5/500   | 20–30  |
| Bread        | 17.5/500   | 30–50  |



 Weight/ defrosting duration







## Dehydrating

Dehydrating or drying is a traditional method of preserving fruit and certain vegetables.

It is important that fruit and vegetables are ripe and not bruised before they are dehydrated.



- Prepare the food for drying by cutting it up, and peeling and coring it if necessary.
- Distribute the food to be dried evenly according to size over the universal tray.
- Select Convection Bake  (Conv Bake).
- Select the desired temperature.
- Place the universal tray on shelf level 3. When using Convection Bake  (Conv Bake) you can dehydrate on levels 2+4 at the same time.
- Turn the food to be dried halfway through the dehydrating time.

The drying times are longer for whole or halved food.

| Food for drying | <input type="checkbox"/>  | <br>[°F (°C)] | <br>[h] |
|-----------------|---|--|--|
| Fruit           |  | 140-160<br>(60-70)   | 2-8  |
| Vegetables      |  | 130-150<br>(55-65)   | 4-12   |
| Mushrooms       |  | 115-125<br>(45-50)   | 5-10   |

Operating mode

Convection Bake  (Conv Bake)

 Temperature,  drying time

- Reduce the temperature if condensation begins to form in the oven.

## Warm-up Cookware

Use the Convection Bake  (Conv Bake) operating mode for preheating dishware.

Only preheat heat-resistant dishware.

- Place the Wire Rack on shelf level 1 and place the dishware to be preheated on it. Depending on the size of the dishware, you can also place it on the oven floor and take the side racks out to make more room.
- Select Convection Bake  (Conv Bake).
- Set the temperature to 120–175°F (50–80°C).

 **Danger of burning!**  
Use pot holders when removing dishware. Condensation may accumulate on the bottom of the dishware.

- Remove the heated dishware from the oven.

## Further applications

### Slow Roasting

Slow Roasting is ideal for cooking delicate cuts of beef, pork, veal, or lamb to perfection.

Always observe USDA/CFIA food safety guidelines.

First briefly sear the meat on all sides at a high temperature on the cooktop in order to seal it.

Then place the meat in the preheated oven where the low temperature and long cooking duration will cook it to perfection and ensure it is very tender.

The meat will relax. The juices inside will start to circulate evenly throughout the meat to reach the outer layers. This gives very tender and succulent results.

- Only use lean meat which has been correctly seasoned and trimmed. Bones should be removed before cooking.
- For searing, use a suitable cooking oil or fat that can withstand high temperatures (e.g., clarified butter, vegetable oil).
- Do not cover meat during the cooking process.

Cooking takes approx. 2–4 hours depending on the weight and size of the meat and how well you want it cooked.

- As soon as the cooking program has finished, you can carve the meat straight from the oven. It does not need to rest.

- You can leave the meat in the oven to keep warm until you serve it. This will not affect results in any way.
- Serve on preheated plates with very hot sauce or gravy to prevent it cooling down too quickly. The meat is at an ideal temperature to eat straight away.

### Using Bake (Bake)

Use the universal tray with the Wire Rack placed on top of it.

- Place the universal tray with Wire Rack on shelf level 3.
- Select the Bake  (Bake) operating mode and a temperature of 175–225°F (80–100°C).
- Preheat the oven together with the universal tray and Wire Rack for approx. 15 minutes.
- While the oven is preheating, sear the meat on all sides on the cooktop.

 Danger of burning due to hot surfaces.

The oven gets hot during operation. You could burn yourself on the heater elements, oven compartment, or accessories.

Use pot holders when placing food in the appliance or removing it and when working in the hot oven compartment.

- Place the seared meat on the Wire Rack.
- Continue cooking the meat until it is done.

You can set the cooking process to finish automatically (see “Using the oven – Operating the clock/timer”).

## Further applications

### Cooking durations/core temperatures

Always observe USDA/CFIA food safety guidelines.

| Meat   | Cooking duration                        | Core temperature  |
|--|---|---|
| Beef tenderloin, approx. 2.2 lbs (1 kg)<br>- rare<br>- medium<br>- well done | 60–80 min<br>75–85 min<br>110–130 min   | 113–119°F (45–48°C)<br>129–135°F (54–57°C)<br>145–151°F (63–66°C) |
| Prime rib, approx. 2.2 lbs (1 kg)<br>- rare<br>- medium<br>- well done       | 70–80 min<br>105–115 min<br>130–140 min | 113–119°F (45–48°C)<br>129–135°F (54–57°C)<br>145–151°F (63–66°C) |
| Pork tenderloin, approx. 0.75 lbs (350 g)                                    | 70–90 min                               | 145–156°F (63–69°C)   |
| Gammon joint*, approx. 2.2 lbs (1 kg)  | 140–160 min                             | 145–151°F (63–66°C)   |
| Veal tenderloin, approx. 2.2 lbs (1 kg)<br>- pink<br>- medium<br>- well done | 45–55 min<br>75–85 min<br>90–100 min    | 113–119°F (45–48°C)<br>129–135°F (54–57°C)<br>145–151°F (63–66°C) |
| Saddle of veal*, approx. 2.2 lbs (1 kg)<br>- pink<br>- medium<br>- well done | 75–85 min<br>100–130 min<br>130–140 min | 113–119°F (45–48°C)<br>129–135°F (54–57°C)<br>145–151°F (63–66°C) |
| Saddle of lamb*  | 40–60 min                               | 129–151°F (54–66°C)   |

\* Boneless

# Further applications

---

## Canning

 Risk of infection from bacteria. The spores of the botulinum bacterium are not sufficiently killed by canning legumes and meat only once. Toxins may form which can lead to serious poisoning. These spores are only destroyed by canning the food again.

After they have cooled down, **always** reheat legumes and meat a second time within 2 days.

 Risk of injury from increased pressure in sealed cans.

Canning food and heating it up in closed containers results in an increase in pressure which can cause them to explode.

Do not use cans for canning or reheating food.

Always observe USDA/CFIA food safety guidelines.

## Preparing fruit and vegetables

The instructions are for 6 jars with a capacity of 1 liter each.

Only use special jars for canning (preserving jars or jars with a screw cap). Only use undamaged jars and rubber rings.

- Rinse the jars with hot water before canning and fill them up to a maximum of 3/4" (2 cm) below the rim.
- Slide the universal tray onto shelf level 3. Place the jars on the tray.
- Select the Convection Bake  (Conv Bake) operating mode and a temperature of 320-340°F (160-170°C).
- Wait until bubbles rise evenly in the jars.



Then reduce the temperature to prevent the contents from boiling over.

## Canning fruit and vegetables

- Set the specified post-canning warming temperature as soon as bubbles are visible in the jars, then leave the jars in the warm oven for the time specified.

## Canning vegetables

- As soon as bubbles are visible in the jars, set the specified preserving temperature and cook the vegetables for the time specified.
- After canning, set the specified post-canning warming temperature, then leave the jars in the warm oven for the time specified.

|                         |  |  |
|-------------------------|---|---|
| Fruit                   | —/—   | 85°F<br>(30°C)/<br>25–35 min  |
| Pickling cucumbers      | —/—   | 85°F<br>(30°C)/<br>25–30 min  |
| Beets                   | 250°F<br>(120°C)/<br>30–40 min  | 85°F<br>(30°C)/<br>25–30 min  |
| Beans (green or yellow) | 250°F<br>(120°C)/<br>90–120 min   | 85°F<br>(30°C)/<br>25–30 min  |

 Canning temperature and time once bubbles are visible in the jars

 Post-canning warming temperature and time

## Removing the jars after canning

 Risk of injury caused by hot surfaces.

The jars will be very hot after canning.

Use oven mitts when removing the jars from the oven.

- Take the jars out of the oven.
- Cover the jars with a towel and leave to set for approx. 24 hours in a draft-free area.
- After they have cooled down, **always** reheat beans and meat a second time within 2 days.
- Remove the fasteners from the jars and make sure all jars are closed properly when storing them.

Either boil open jars again or store them in a cool place and consume the preserved fruit or vegetables immediately.

- Check the jars during storage. If jars have opened during storage or if the screw cap is bulging and does not make a popping noise when opened, dispose of the contents.

## Further applications

---

### Frozen food/ready meals

#### Tips for cakes, pizza, and baguettes

- Bake cakes, pizza, and baguettes on parchment paper on the wire rack.
- Use the lowest temperature recommended by the manufacturer.

#### Tips for French fries, croquettes, and similar items

- Cook frozen food items on parchment paper placed on a baking tray or the universal tray.
- Use the lowest temperature recommended by the manufacturer.
- Turn several times during cooking.

### Preparing frozen food/ready meals

Handling and cooking food correctly is essential for maintaining good health.

Cakes, pizzas, and French fries should be cooked until golden, not dark brown.

- Select the operating mode and temperatures recommended on the food's packaging.
- Preheat the oven.
- Place the food in the preheated oven on the shelf level recommended on the packaging.
- Check the food at the end of the shortest time recommended on the packaging.

# Gas cooktop cleaning and care

 Danger of injury caused by hot burners.

The burners will be hot after use.

Turn off the cooktop.

Allow the burners to cool down before cleaning the cooktop.

 Risk of injury due to electric shock.

The steam from a steam cleaning appliance could reach live electrical components and cause a short circuit.

Never use a steam cleaner for cleaning.

All surfaces could be discolored or damaged if unsuitable cleaning agents are used. All surfaces are susceptible to scratching.

Remove any residual cleaning agent immediately.

Do not clean with any abrasive or sharp pointed objects.

## Unsuitable cleaning agents

To avoid damaging the surfaces of your appliance, do not use:

- cleaning agents containing soda, alkali, ammonia, acids, or chlorides
- cleaning agents containing descaling agents
- stain or rust removers
- abrasive cleaning agents (e.g., powder cleaners and cream cleaners)
- solvent-based cleaning agents
- dishwasher cleaning agents
- grill and oven sprays
- glass cleaners
- hard, abrasive brushes or sponges (e.g., pot scourers, brushes, or sponges which have been previously used with abrasive cleaning agents)
- sharp objects
- eraser sponges

The surfaces of the burners and grates will become more matte in the course of time. This is quite normal and does not indicate damage to the material.

- Clean the cooktop after each use with a soft sponge, warm water and a small amount of liquid dish soap.
- Soften any stubborn soiling beforehand.
- Dry the cooktop after using water to clean it. This helps prevent lime deposits.

# Gas cooktop cleaning and care

---

**Tip:** Food which boils over on a hot cooktop can cause discoloration of the burner components. Remove any soiling and salt and sugar splashes immediately.

## Cleaning the grates

- Remove the grates.
- Clean the grates in a dishwasher or with a solution of warm water and a little liquid dish soap applied with a soft sponge.
- If necessary, the rough side of a kitchen sponge can be used.

## Control knobs in stainless steel color

Do not clean the control knobs in the dishwasher or with a stainless steel cleaning agent.

Clean the control knobs using a solution of warm water and a little liquid dish soap applied with a soft sponge.

The control knobs may become discolored if they are not cleaned regularly.

- Clean the control knobs using a solution of warm water and a little liquid dish soap applied with a soft sponge.

## Cleaning the normal/power burners

The burner cap is not dishwasher-safe.

Make sure that the flame holes are completely dry after cleaning.

- Remove the burner cap.
- Clean the burner cap using a soft sponge, warm water and a small amount of liquid dish soap.
- Clean all non-removable parts of the burner with a damp cloth.

## Ignitor

Do not let the ignitor get wet. If it gets wet, it will not spark.

- Clean the ignitor carefully with a well wrung-out cloth.



# Gas cooktop cleaning and care

## Cleaning the grill

- Clean the grill after each use with hot water and a small amount of liquid dish soap.
- If the grill is very dirty, soak it first before removing the soiling with a brush.
- Then leave the grill to dry thoroughly.

## Disassembling the grill

 **Danger of burning!**  
Burners must be switched off. Make sure the cooktop has cooled down.

To make cleaning easier, you can dismantle the grill.

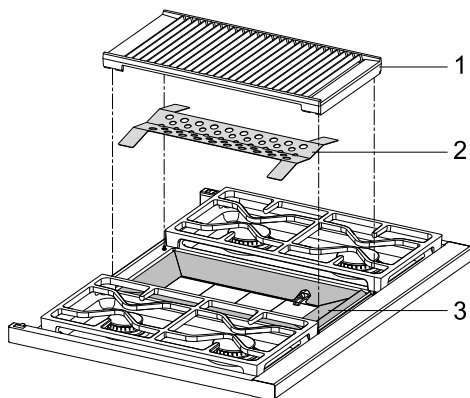

- ① Grill
- ② Protective panel
- ③ Frame

 **Risk of injury!**  
The cast-iron grill is heavy.  
Carry the grill carefully and place it securely on a soft surface so that it lies flat.

- Remove the grill ① from the cooktop.
- Remove the protective panel ② and, if required, the frame ③.
- Clean the parts with warm water, liquid dish soap, and a soft sponge.
- Dry all parts with a soft cloth.

Reinstall by following these instructions in reverse order.

- Place the frame ③ on the surface burner. The recess for the igniter is located on the right side in the lower quarter of the frame.
- Place the protective panel ② on the frame ③.

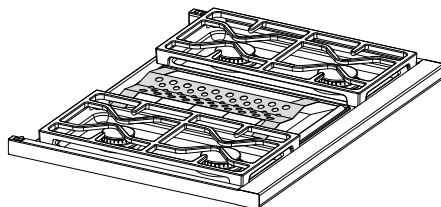

- Replace the grill ①.

# Gas cooktop cleaning and care

---

## Cleaning the griddle plate



**Burn hazard!**

Allow the griddle plate to cool down sufficiently before cleaning it.



**Fire hazard!**

Clean the grease catch pan after every use of the griddle plate.

- Loosen coarse soiling immediately with a spatula and scratch grease and residue into the grease drip tray.
- Remove any excess grease with a paper towel.
- Once the griddle plate has cooled down, add some hot water and liquid dish soap and leave it to soak.
- Remove the soiling and water with a sponge.

You can clean stubborn soiling off the griddle plate with the rough side of a dish sponge and a few drops of Miele Ceramic and Stainless Steel Cleaner (see “Features”).

- Remove the grease drip tray and empty it.
- Clean the grease drip tray with a soft sponge, warm water, and a small amount of liquid dish soap.
- Then dry the grease drip tray.
- Remove the soapy water and soiling from the griddle plate.
- Finally, clean the griddle plate with a damp cloth.
- Dry the griddle plate with a clean cloth.

- Rub a little vegetable oil onto the griddle plate after cleaning it.
- Replace the grease drip tray.

# Cleaning and care of the oven

 Risk of injury caused by hot surfaces.

The oven gets hot during operation. You could burn yourself on the heating elements, oven compartment, or accessories. Allow the heating elements, oven compartment, and accessories to cool before manual cleaning.

 Risk of injury due to electric shock.

The steam from a steam cleaning appliance could reach live electrical components and cause a short circuit. Never use a steam cleaner for cleaning.

All surfaces could be discolored or damaged if unsuitable cleaning agents are used. The oven front is particularly susceptible to damage from oven cleaners or descaling agents.

All surfaces are susceptible to scratching. Scratches on glass can lead to breakage in some circumstances.

Remove all cleaning agent residues immediately.

- Abrasive cleaning agents (e.g., powder cleaners and cream cleaners)
- Solvent-based cleaning agents
- Stainless steel cleaning agents
- Dishwasher cleaner
- Glass cleaners
- Cleaning agents for ceramic cooktops
- Hard, abrasive brushes or sponges (e.g., pot scourers, brushes, or sponges which have been previously used with abrasive cleaning agents)
- Eraser sponges
- Sharp metal scrapers
- Steel wool
- Spot cleaning with mechanical cleaning agents
- Oven cleaners
- Stainless-steel spiral pads

If soiling is allowed to sit for any length of time, it may become impossible to remove. If items are used frequently without being cleaned, it may become very difficult to clean them.

It is therefore best to remove any soiling immediately.

The accessories are not dishwasher-safe.

## Unsuitable cleaning agents

To avoid damaging the surfaces of your appliance, do not use:

- Cleaning agents containing soda, ammonia, acids, or chlorides
- Cleaning agents containing descaling agents on the front

# Cleaning and care of the oven

---

**Tip:** Soiling caused by spilled fruit juices and cake mixtures is best removed while the oven is still warm. Use caution and make sure the oven is not too hot.

To make it easier to clean the oven:

- Remove the door.
- Remove the side racks.

## Removing normal soiling

There is a fiberglass seal around the oven compartment which seals the inside of the glass oven door and can be damaged by rubbing and scouring.

Avoid cleaning the fiberglass seal. The fiberglass seal is essential for sealing the door properly.

- Remove normal soiling immediately with warm water, liquid dish soap, and a clean sponge or a clean, damp microfiber cloth.
- Remove all cleaning agent residues thoroughly with clean water. This is particularly important for any parts with a PerfectClean finish, as cleaning agent residues will impair the non-stick function.
- After cleaning, wipe the surfaces dry using a soft cloth.

## Removing stubborn soiling

Do not line the oven (e.g., with aluminum foil) and do not use standard oven cleaners unless they are suitable for use in a self-cleaning oven.

Spilt fruit and roasting juices may cause lasting discoloration or matte patches on surfaces. This discoloration will not affect the properties of the surface finish.

Do not attempt to remove these marks. Clean them following the instructions given here.

- Baked-on deposits can be removed with a glass scraper or with a stainless-steel spiral pad, hot water, and liquid dish soap.

You do not need to treat the oven compartment with an oven cleaner as the oven comes with  Self Clean.

- If necessary, you can use the scouring pad on the back of a non-scratching dish sponge to remove the soiling after the holding time.
- Remove all cleaning agent residues thoroughly with clean water.
- Dry all surfaces with a soft cloth.

## Cleaning the oven compartment with Self clean (Clean)

Instead of cleaning the oven manually you can use the Self clean  (Clean) operating mode.

During the Self Clean function, the oven compartment reaches temperatures in excess of 750°F (400°C). Any grime that has accumulated will be broken down and burnt to ash as a result of the high temperatures.

There are 3 Self Clean settings available, each with a different duration:

- Level 1 for light soiling
- Level 2 for heavier soiling
- Level 3 for very heavy soiling

The oven door is automatically locked when the Self Clean process starts. It cannot be opened until after the program has finished.

The timer can be used to delay the start time of the Self Clean program.

At the end of the Self Clean program, any residues such as ash from the cleaning process, which are formed depending on the oven compartment's degree of soiling, can be easily wiped away.

## Preparing for Self Clean

Accessories that are not suitable for the Self Clean program will be damaged by the high temperatures. Remove all accessories that are not suitable for the Self Clean program from the oven compartment before starting the Self Clean process. This also applies for optional accessories that are not suitable for the Self Clean program.

The following accessories are suitable for the Self Clean program and can be left in the oven compartment during the process:

- Side runners
- FlexiClips with Wire Rack HFCBBR 36-3
- Wire rack HBRR 36-2
- Remove all accessories that are not suitable for the Self Clean program from the oven.
- Slide the wire rack into the top shelf level.

Coarse soiling in the oven compartment can cause thick smoke to develop.

Burnt-on residues can cause lasting discoloration or dull spots on enameled surfaces.

Before starting the Self Clean program, remove coarse soiling from the oven compartment and scrape any burnt-on residues off enameled surfaces with a glass scraper.

# Cleaning and care of the oven

## Starting Self Clean

 **Danger of burning!**  
The front of the oven gets hotter in the Self Clean program than it does in normal oven modes.

Do not let children touch the appliance during the Self Clean program.

- Select the Self clean  (Clean) operating mode.

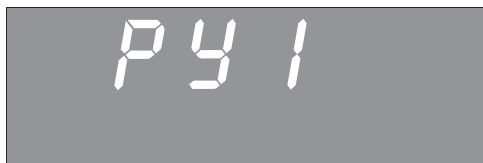

*PY 1* appears. The number will flash.



Use < or > to choose between the *PY 1*, *PY 2*, and *PY 3* Self Clean levels.

- Select the desired Self Clean level.
- Confirm with *OK*.

The Self Clean program will start.

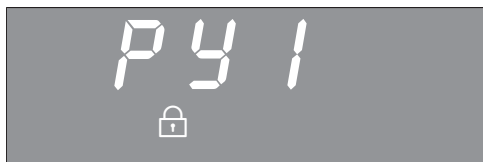
 will also appear in the display.





While  is flashing, the door is locked automatically.  lights up as long as it is locked.

The oven heating and the cooling fan will then turn on automatically.

The oven interior lighting will not come on during the Self Clean program.

If you want to see how the Self Clean program is progressing, you need to highlight the duration symbol  in the display.



- Select *OK*.
- If necessary, use < or > to move the triangle  until it appears under .

The time left for the Self Clean program will start counting down on the display. You cannot alter the duration.

You can use the timer while the Self Clean program is running. When the set time has elapsed, the audible signal will sound and  will flash. The time will then continue to increase on the display. The audible signal will stop and the symbols in the display will go out as soon as you confirm with *OK*. *PY* and the number of the selected Self Clean program will appear again.

## Starting Self Clean at a later time

Start the Self Clean program as described above and then set the required finish time within the first five minutes of starting the program.

- Select *OK*.
- Move the triangle  with < or > until it appears under .

*---* appears.

- Confirm with *OK*.

The display will show the finish time calculated from the current time of day plus the duration of the selected Self Clean program.

- Set the desired finish time using < or >.
- Confirm with *OK*.

# Cleaning and care of the oven

The finish time is now saved.



The oven heating switches off.



The finish time can be changed at any time up until the start time for the program.

As soon as the start time is reached, the oven heating and the cooling fan will switch on. The duration will appear in the display.



## At the end of the Self Clean program



0:00, , and  will appear in the display.

As long as  lights up, the door is locked. When  flashes, the door is unlocked.

When the door lock has been deactivated:

-  goes out.
-  flashes.
- Short signals will sound if the audible signal is switched on.

■ Turn the mode selector to *Off*.

The audible signal will stop and the symbols on the display will go out.

 Danger of injury caused by hot surfaces.

At the end of the Self Clean program, the oven will still be very hot. You could burn yourself on the heater elements and the oven compartment.

Allow the heating elements and the oven compartment temperature to drop to a safe level before removing any residues.

- Clean the oven compartment to remove any Self Clean residues (e.g., ash) that can build up depending on the degree of soiling in the oven compartment.

Most residues can be removed with warm water, liquid dish soap, and a clean sponge or a clean, damp microfiber cloth.

Depending on how dirty the oven was prior to cleaning, there may be a visible layer of soiling across the inner glass pane on the door. You can remove this using the scouring side of a dish sponge, a glass scraper, or with a stainless steel spiral pad and liquid dish soap.



# Cleaning and care of the oven

---







## Please note:

- There is a fiberglass seal around the oven compartment which seals the inside of the glass oven door and can be damaged by rubbing and scouring. Do not clean the door seal – it is essential for sealing the door properly.
- Spilled fruit juices may cause lasting discoloration of enameled surfaces. This discoloration is permanent but will not affect the properties of the enamel. Do not attempt to remove these stains.

## Self Clean interrupted

If the Self Clean program is canceled, the oven door will remain locked until the temperature inside the oven drops to below 535°F (280°C).  remains lit up until the temperature of the oven compartment has fallen below this temperature. When  flashes, the door is unlocked.

The following events will cause the Self Clean program to stop:

- The mode selector is turned to *Off*.  
Once the door has been unlocked,  will go out and the time of day will appear. Start the Self Clean program again if necessary.
- The mode selector is turned to a different operating mode.  
*Py* and  appear. Once the door has been unlocked,  will go out and *Py* will flash. Start the Self Clean program again if necessary.
- A power failure occurs.  
*Py* and  appear. Once the door has been unlocked,  will go out and *Py* will flash.  
When power is restored, *Py* remains lit up until the temperature of the oven compartment has fallen below 535°F (280°C).  will then appear. The door is unlocked and the time of day will appear.



# Cleaning and care of the oven

## Removing the door

The door weighs approx. 48.5 lbs (22 kg).

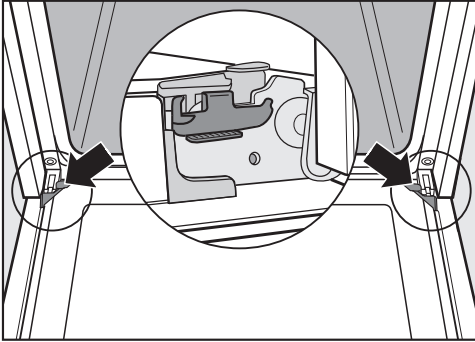

The oven door is connected to the hinges by retainers. Before removing the door from the retainers, the locking clamps on both hinges have to be released.

- Open the door fully.

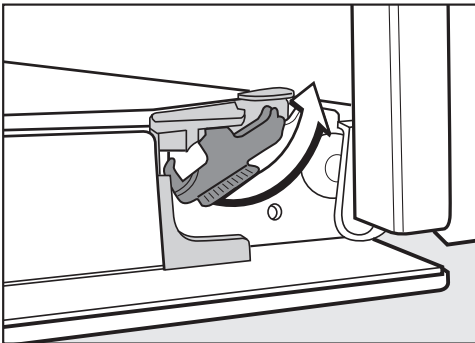

- Release the locking clamps by turning them as far as they will go.

You could damage the oven if you remove the door incorrectly. Do not pull the door horizontally off its retainers, as they will spring back against the oven. Do not pull the door off the retainers by the handle, as the handle could break off.

- Raise the door up till it rests partially open.

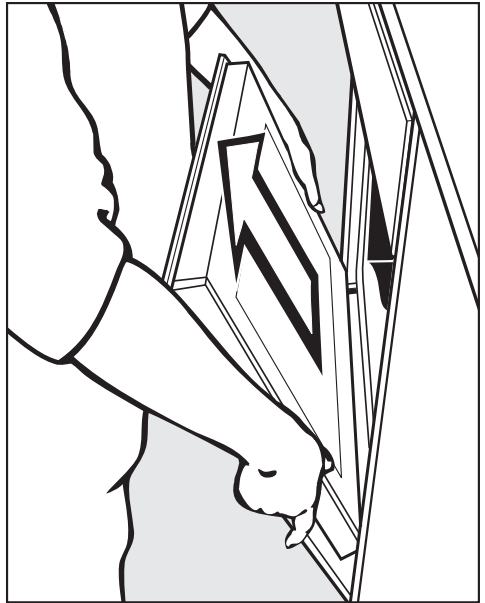

- Hold the door on either side and pull it upwards off the hinge retainers. Make sure that the door is straight.

# Cleaning and care of the oven

## Installing the door

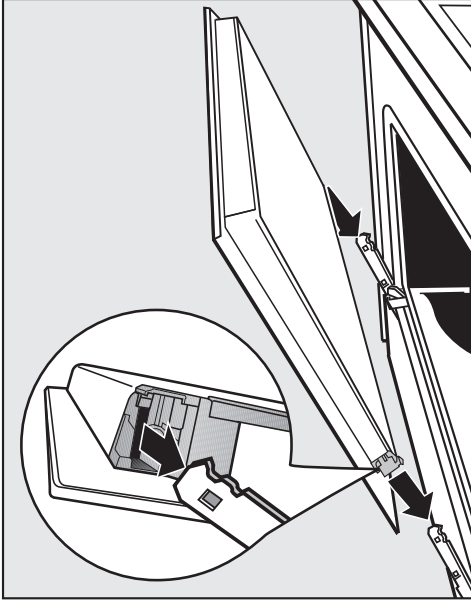

- Hold the door securely on both sides and carefully install it back into the hinge retainers. Make sure that you do not tilt the door.

- Open the door fully.

If the locking clamps are not locked, the door could become loose, resulting in damage.

Ensure that the locking clamps are locked after reinstalling the door.

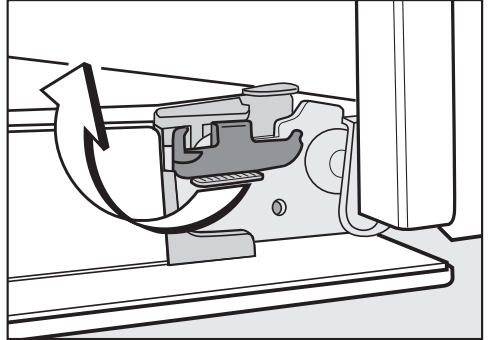

- To relock the locking clamps, turn them back up to the horizontal position as far as they will go.

## Side rack removal

 Danger of injury caused by hot surfaces.

The oven gets hot during operation. You could burn yourself on the heater elements, oven compartment, or accessories.

Allow the heating elements, oven compartment, and accessories to cool before removing the side racks.

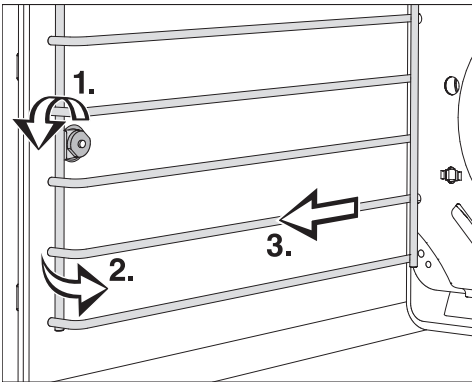

- Loosen the knurled screw (1.).
- Pull the side racks forwards out of the holder (2.).
- Remove the side racks (3.).

**Reinstall** by following these instructions in reverse order.

- Insert the components carefully.

## Frequently Asked Questions

---

With the help of the following guide minor faults in the performance of the machine, some of which may result from incorrect operation, can be remedied without contacting the Service Department.



This guide may help you to find the reason for the fault, and how to correct it.

| <b>Problem</b>  | <b>Possible cause and solution</b>  |
|---|---|
| <b>The burners do not ignite when the cooktop is being used for the first time or after it has been out of use for a longer period.</b> | There may be air in the gas line.<br>■ Try to light the burner again, making several attempts if necessary. |
| <b>The burner does not light after several attempts.</b>  | The burner is not properly assembled.<br>■ Assemble the burner correctly.                                   |
|   | The gas shutoff valve is closed.<br>■ Open the gas shut-off valve.  |
|   | The burner is wet and/or dirty.<br>■ Clean and dry the burner.  |
|   | The flame holes are clogged and/or wet.<br>■ Clean and dry the flame holes.                                 |
| <b>The gas flame goes out after being lit.</b>  | The burner parts are not in the proper position.<br>■ Position the burner parts correctly.                  |
|   | The ignitor is dirty.<br>■ Remove any dirt or grime.  |
| <b>The shape/color of the gas flame changes.</b>  | The burner parts are not in the proper position.<br>■ Position the burner parts correctly.                  |
|   | The burner cap itself or the holes in the burner cap are dirty.<br>■ Remove any dirt or grime.              |
| <b>The gas flame goes out during use.</b>   | The burner parts are not in the proper position.<br>■ Position the burner parts correctly.                  |

## Frequently Asked Questions

| Problem  | Possible cause and solution  |
|--|--|
| <p><b>The ignitor does not function properly.</b></p>  | <p>The breaker in the building's wiring system has tripped.</p> <ul style="list-style-type: none"> <li>■ Contact a qualified electrician or Miele Customer Service if necessary.</li> </ul>  |
|  | <p>There is food residue stuck between the ignitor and the burner cap.</p> <ul style="list-style-type: none"> <li>■ Remove any soiling (See "Gas cooktop cleaning and care").</li> </ul>   |
| <p><b>Grill and griddle plate switch off/cannot be switched on</b></p>                             | <p>The grill and griddle plate will be switched off as soon as you start the Self Clean program on the oven. This is not a fault. This has triggered the safety shut-off.</p> <ul style="list-style-type: none"> <li>■ Turn the control knob for the grill and griddle plate to <i>Off</i>. As soon as the Self Clean program has finished, you can switch the grill and griddle plate back on again.</li> </ul> |
|  | <p>The grill and griddle plate cannot be turned on while the Self Clean program is running on the oven. This is not a fault. This has triggered the safety shut-off.</p> <ul style="list-style-type: none"> <li>■ Turn the control knob for the grill and griddle plate to <i>Off</i>. As soon as the Self Clean program has finished, you can switch the grill and griddle plate back on again.</li> </ul>      |
| <p><b>Grill and griddle plate cannot be switched back on immediately after switching off</b></p>   | <p>The appliance performs a safety check before the ignitor ignites. This is not a fault. After a few seconds, the ignitor will "click" and ignite the gas.</p> <ul style="list-style-type: none"> <li>■ Push in the control knob for the grill or griddle plate and turn it counterclockwise to <i>High</i> until the burner ignites.</li> </ul>  |
| <p><b>With cooktops using LP gas a buzzing noise can be heard during the heating-up phase.</b></p> | <p>This is not a fault. The noise will cease after a few seconds.</p>  |
| <p><b>The display is dark.</b></p>   | <p>There is no power to the oven.</p> <ul style="list-style-type: none"> <li>■ Check if the breaker has tripped. If it has, contact a qualified electrician or Miele Customer Service.</li> </ul>  |

## Frequently Asked Questions

| Problem   | Possible cause and solution   |
|---|---|
| <p><b>The oven does not heat up.</b></p>  | <p>You have only selected an operating mode or a temperature.</p> <ul style="list-style-type: none"> <li>■ Select both a mode <b>and</b> a temperature.</li> </ul> <p>The system lock  is activated.</p> <ul style="list-style-type: none"> <li>■ Switch the system lock off (see “Using the oven – Operating the clock/timer”).</li> </ul> <p>There is no power to the oven.</p> <ul style="list-style-type: none"> <li>■ Check if the breaker has tripped. If it has, contact a qualified electrician or Miele Customer Service.</li> </ul> <p>Demo mode is activated. <i>DE5_</i> appears. The oven can be operated, however the heating elements will not work.</p> <ul style="list-style-type: none"> <li>■ Deactivate demo mode (see “Using the oven – Operating the clock/timer”).</li> </ul> |
| <p><b>12:00 is flashing in the display.</b></p>   | <p>There has been a power failure.</p> <ul style="list-style-type: none"> <li>■ Reset the time of day (see “Before using for the first time”).</li> </ul> <p>Cooking times will also need to be reset.</p>  |
| <p><b>0:00 appears unexpectedly in the display and  is flashing at the same time. The audible signal might also be sounding.</b></p> | <p>The oven has been operating for an unusually long period of time, and this has activated the safety shut-off.</p> <ul style="list-style-type: none"> <li>■ Turn the mode selector to <i>Off</i>. The oven is ready for use again immediately.</li> </ul>   |
| <p><b>F 32 appears on the display.</b></p>  | <p>The door lock for the Self Clean program has not locked.</p> <ul style="list-style-type: none"> <li>■ Turn the mode selector to <i>Off</i> and select the Self Clean program again.</li> </ul> <p>If the problem persists, contact Miele Customer Service.</p>   |
| <p><b>F 33 appears on the display.</b></p>  | <p>The door lock for the Self Clean program has not opened.</p> <ul style="list-style-type: none"> <li>■ Turn the mode selector to <i>Off</i> and switch the oven off.</li> </ul> <p>If the problem persists, contact Miele Customer Service.</p>   |

## Frequently Asked Questions

| Problem   | Possible cause and solution  |
|---|--|
| <b>F and a fault code not listed here appear on the display.</b>                  | <p>A fault has occurred that you cannot resolve.</p> <ul style="list-style-type: none"> <li>■ Contact Miele Customer Service.</li> </ul>   |
| <b>A noise is heard after the cooking process is complete.</b>                    | <p>After the cooking process the cooling fan will continue to run for a while after a program is complete to prevent moisture from building up in the oven, on the control panel or surrounding cabinetry.</p> <p>The cooling fan will turn off automatically.</p>   |
| <b>The oven has turned itself off.</b>  | <p>To save power, the oven turns off automatically if a button is not pressed after a certain amount of time or after a cooking program has ended.</p> <ul style="list-style-type: none"> <li>■ Turn the oven back on.</li> </ul>  |
| <b>The cake/cookies are not baked properly.</b>                                   | <p>A different temperature than that given in the recipe was used.</p> <ul style="list-style-type: none"> <li>■ Select the temperature required for the recipe.</li> </ul>   |
|   | <p>The ingredient quantities are different from those given in the recipe.</p> <ul style="list-style-type: none"> <li>■ Check if you have amended the recipe. The addition of more liquid or more eggs will make a wetter mixture which will take longer to cook.</li> </ul>   |
| <b>The browning is uneven.</b>  | <p>The wrong temperature or shelf level was selected.</p> <ul style="list-style-type: none"> <li>■ There will always be a slight unevenness. If browning is very uneven, check whether you selected the correct temperature and shelf level.</li> </ul>  |
| <b>There is still soiling in the oven compartment after a Self Clean program.</b> | <p>The Self Clean program burns off soiling in the oven and leaves it as ash.</p> <ul style="list-style-type: none"> <li>■ Remove the ash with warm water, liquid dish soap, and a clean sponge or a clean, damp microfiber cloth.</li> </ul> <p>If there is still coarse soiling left in the oven after the Self Clean program, you should start the program again, selecting a longer duration if necessary.</p> |

## Frequently Asked Questions

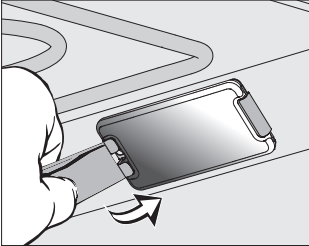
| Problem   | Possible cause and solution  |
|---|--|
| <p><b>The accessories make noises when they are pushed into or pulled out of the oven.</b></p>  | <p>The Self-Clean-resistant surface of the side runners creates friction when accessories are pushed into or pulled out of the oven.</p> <ul style="list-style-type: none"> <li>■ To reduce the friction, add a few drops of heat-resistant cooking oil to some kitchen paper and use this to lubricate the side runners. Repeat this after every Self Clean program.</li> </ul>   |
| <p><b>The oven interior lighting turns off after a short time.</b></p>  | <p>The oven lighting is set to switch off after 15 seconds (default setting). You can change this setting (see “Using the oven – Operating the clock/timer”).</p>  |
| <p><b>The oven interior lighting does not turn on.</b></p>  | <p>The halogen lamp is faulty.</p> <div style="border: 1px solid gray; padding: 5px; margin-bottom: 10px;"> <p><b>⚠ Danger of injury caused by hot surfaces.</b><br/>The oven gets hot during operation. You could burn yourself on the heater elements, oven compartment, or accessories.<br/>Allow the heater elements, oven compartment, and accessories to cool before manual cleaning.</p> </div> <div style="border: 1px solid gray; padding: 5px; margin-bottom: 10px;"> <p>The lamp cover may be damaged if it falls down. Hold onto the lamp cover while removing it so it does not fall down. Place a cloth over the oven floor to protect it and the open door.</p> </div> <ul style="list-style-type: none"> <li>■ Disconnect the oven from the electrical supply. Unplug the appliance or switch off the breaker.</li> <li>■ Remove the lamp cover from the frame from behind with the tool supplied.</li> <li>■ Do not grasp the halogen lamp with your bare fingers. Please follow the manufacturer’s instructions.<br/>Remove the halogen lamp.</li> <li>■ Replace the halogen lamp (Osram 66725 AM/A, 230 V, 25 W, G9).</li> <li>■ Press the lamp cover back into place.</li> <li>■ Reconnect the oven to the electrical supply.</li> </ul> |



## Contact in the event of a fault

In the event of a fault which you cannot remedy yourself, please contact your Miele dealer or Miele Customer Service.

You can book a Miele Service Call online at [www.miele.com/service](http://www.miele.com/service).

Contact information for Miele Customer Service can be found at the end of this document.

Please quote the model identifier and serial number of your appliance (SN) when contacting Miele Customer Service. Both pieces of information can be found on the data plate.

This information is given on the data plate, visible on the front frame of the oven, with the door fully open.

## Appliance warranty and product registration

You can register your product and/or view the manufacturer's warranty terms and conditions for Miele appliances and vacuum cleaners at [www.mieleusa.com](http://www.mieleusa.com).

# Caring for the environment

---

## Disposal of the packing material

The cardboard box and packing materials protect the appliance during shipping. They have been designed to be biodegradable and recyclable.

Ensure that any plastic wrappings, bags, etc. are disposed of safely and kept out of the reach of children.  
Danger of suffocation!

## Disposal of your old appliance

Electrical and electronic appliances contain valuable materials. They also contain certain substances, compounds and components which were essential for the proper functioning and safe use of the equipment. Handling these materials improperly by disposing of them in your household waste can be harmful to your health and the environment. Therefore, please do not dispose of your old appliance with regular household waste and follow local regulations on proper disposal.



Consult with local authorities, dealers or Miele in order to dispose of and recycle electrical and electronic appliances. Miele assumes no responsibility for deleting any personal data left on the appliance being disposed. Please ensure that your old appliance is kept away from children until removal. Observe safety requirements for appliances that may tip over or pose an entrapment hazard.

**Please have the model and serial number  
of your appliance available when  
contacting Customer Service.**

---

## **U.S.A.**

**Miele, Inc.**

### **National Headquarters**

9 Independence Way  
Princeton, NJ 08540  
[www.mieleusa.com](http://www.mieleusa.com)

### **Customer Support**

Phone: 888-99-MIELE (64353)  
[info@mieleusa.com](mailto:info@mieleusa.com)

### **International Headquarters**

Miele & Cie. KG  
Carl-Miele-Straße 29  
33332 Gütersloh  
Germany

## **Canada**

**Importer  
Miele Limited**

### **Headquarters and Miele Centre**

161 Four Valley Drive  
Vaughan, ON L4K 4V8  
[www.miele.ca](http://www.miele.ca)

### **Customer Care Centre**

Phone: 800-565-6435  
905-532-2272  
[customercare@miele.ca](mailto:customercare@miele.ca)

HR 1134-3 AG, HR 1135-3 AG, HR 1136-3 AG

en-US, CA

M.-Nr. 11 918 970 / 02