

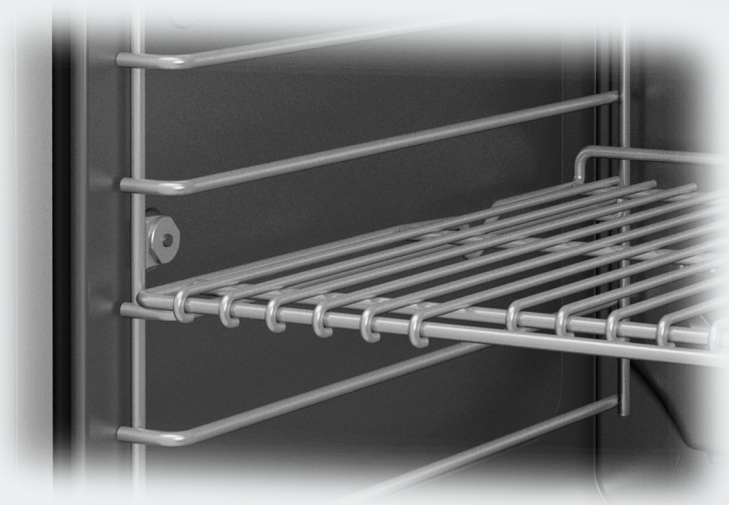

## Operating and Installation Instructions Oven





To prevent accidents and machine damage, read these instructions **before** installation or use.

# Contents



---

|   |    |
|---|----|
| <b>IMPORTANT SAFETY INSTRUCTIONS</b> .....  | 8  |
| <b>Guide to the oven</b> .....  | 18 |
| <b>Control panel</b> .....  | 19 |
| Sensor buttons .....  | 20 |
| M Touch display .....   | 21 |
| Symbols.....  | 22 |
| Using the appliance.....  | 23 |
| <b>Features</b> .....   | 25 |
| Model numbers .....   | 25 |
| Data plate .....  | 25 |
| Items included .....  | 25 |
| Standard and optional accessories.....  | 25 |
| Shelf runners .....   | 25 |
| Universal tray and wire oven rack with anti-tip safety notches .....                                | 26 |
| FlexiClips with wire rack HFCBBR 30-2 .....   | 27 |
| Oven controls .....   | 30 |
| Oven safety features .....  | 31 |
| System lock  ..... | 31 |
| Sensor lock for the oven .....  | 31 |
| Safety shut-off.....  | 31 |
| Cooling fan .....   | 31 |
| Vented oven door .....  | 31 |
| Safety Door Lock for Self Clean .....   | 31 |
| PerfectClean surfaces .....   | 32 |
| Self Clean ready accessories .....  | 32 |
| <b>Before first use</b> .....   | 33 |
| Standard settings .....   | 33 |
| Heating up the oven for the first time and rinsing the steam injection system .....                 | 35 |
| <b>Settings</b> .....   | 36 |
| Accessing the “Settings” menu.....  | 36 |
| Changing and saving settings .....  | 36 |
| Settings overview .....   | 37 |
| Language  .....  | 39 |
| Time of day.....  | 39 |
| Display.....  | 39 |
| Clock type .....  | 39 |
| Clock format.....   | 39 |
| Set .....   | 39 |
| Synchronize.....  | 39 |

|   |    |
|---|----|
| Date .....  | 40 |
| Lighting.....   | 40 |
| Start screen .....  | 40 |
| Brightness .....  | 40 |
| Volume.....   | 41 |
| Buzzer tones.....   | 41 |
| Keypad tone .....   | 41 |
| Welcome melody.....   | 41 |
| Units of measurement .....  | 41 |
| Weight .....  | 41 |
| Temperature .....   | 41 |
| Cooling fan .....   | 42 |
| Recommended temperatures.....   | 42 |
| Self Clean .....  | 43 |
| Safety .....  | 43 |
| System lock  .....       | 43 |
| Sensor lock .....   | 44 |
| Catalyzer.....  | 44 |
| Voltage.....  | 45 |
| Sensor group.....   | 45 |
| Calibrate temperature.....  | 45 |
| Showroom program.....   | 46 |
| Demo mode.....  | 46 |
| Factory default settings .....  | 46 |
| <b>MyMiele</b> .....  | 47 |
| To add an entry.....  | 47 |
| Editing MyMiele .....   | 47 |
| Deleting entries.....   | 47 |
| Sorting entries .....   | 47 |
| <b>Alarm + Timer</b> .....  | 48 |
| Using the alarm  ..... | 48 |
| Setting the alarm .....   | 48 |
| Changing an alarm .....   | 48 |
| Deleting an alarm .....   | 48 |
| Using the Timer  ..... | 49 |
| Setting the timer .....   | 49 |
| Changing the timer .....  | 50 |
| Deleting the timer .....  | 50 |
| <b>Guide to the modes</b> .....   | 51 |

# Contents

---

|  |    |
|--|----|
| <b>Operating the oven</b> .....  | 54 |
| Energy saving tips .....   | 54 |
| Quick Guide.....   | 55 |
| Cooling fan .....  | 55 |
| <b>Additional functions</b> .....  | 56 |
| Changing the temperature.....  | 57 |
| Rapid heat-up.....   | 57 |
| Rapid PreHeat .....  | 58 |
| Using the Crisp function (moisture reduction).....   | 58 |
| Changing the operating mode.....   | 59 |
| Setting additional durations .....   | 60 |
| Turning off automatically .....  | 60 |
| Turning on and off automatically .....   | 61 |
| Sequence of a cooking program that turns on and off automatically .....  | 61 |
| Changing set durations .....   | 62 |
| Canceling cooking.....   | 62 |
| <b>Moisture Plus</b>  .....                   | 63 |
| Cooking with the Moisture Plus  function..... | 64 |
| Setting the temperature.....   | 64 |
| Setting the number of steam bursts.....  | 64 |
| Timing the bursts of steam.....  | 64 |
| Changing the type of heating .....   | 64 |
| Injecting bursts of steam .....  | 65 |
| Automatic burst of steam .....   | 65 |
| 1, 2, or 3 bursts of steam .....   | 65 |
| Evaporating residual moisture.....   | 66 |
| Starting residual water evaporation immediately .....  | 66 |
| Skipping residual moisture evaporation .....   | 67 |
| <b>Gourmet Center</b> .....  | 68 |
| List of food types.....  | 68 |
| MasterChef +.....  | 68 |
| Using MasterChef and MasterChef + programs .....   | 68 |
| Notes on using these programs .....  | 69 |
| Search .....   | 70 |

# Contents

---

|                                |            |
|--------------------------------|------------|
| MasterChef + Recipes.....      | 70         |
| Baguette + .....               | 71         |
| Banana Bread + .....           | 72         |
| Brioche + .....                | 73         |
| Ciabatta +.....                | 74         |
| Cinnamon Raisin Bread + .....  | 75         |
| French Bread + .....           | 76         |
| Italian Bread + .....          | 77         |
| Jalapeño Cheese Bread + .....  | 78         |
| Multigrain Bread + .....       | 79         |
| Rolls + .....                  | 80         |
| Rye Bread +.....               | 81         |
| San Francisco Sourdough +..... | 82         |
| Walnut Bread +.....            | 83         |
| White Bread +.....             | 84         |
| Whole Grain Bread + .....      | 85         |
| Mini Cheesecake + .....        | 86         |
| Mini Chocolate Cakes + .....   | 87         |
| Turnovers +.....               | 88         |
| Branzino + .....               | 90         |
| Cod Fillet + .....             | 91         |
| Halibut + .....                | 92         |
| Red Snapper + .....            | 93         |
| Sea Bass + .....               | 94         |
| Trout + .....                  | 95         |
| Whole Salmon Fillet + .....    | 96         |
| Beef Tenderloin + .....        | 97         |
| Bison Rib Roast + .....        | 98         |
| Bison Short Ribs + .....       | 99         |
| Lamb Crown Roast + .....       | 100        |
| Lamb Shanks + .....            | 101        |
| Veal Rib Roast + .....         | 102        |
| Venison Rib Roast + .....      | 103        |
| Chicken + .....                | 104        |
| Duck + .....                   | 105        |
| Turkey +.....                  | 106        |
| Coquilles St. Jacques + .....  | 107        |
| Lobster Tails + .....          | 108        |
| Oysters Rockefeller + .....    | 109        |
| <b>Favorites.....</b>          | <b>110</b> |
| Creating a Favorite .....      | 110        |
| Starting a Favorite .....      | 111        |

# Contents

---

|  |     |
|--|-----|
| Changing Favorites.....  | 111 |
| Changing cooking stages.....   | 111 |
| Changing the name .....  | 112 |
| Deleting a Favorite.....   | 112 |
| <b>Bake</b> .....  | 113 |
| <b>Roast</b> .....   | 115 |
| Roast probe.....   | 116 |
| How it works.....  | 116 |
| When to use the roast probe.....   | 117 |
| Important notes regarding the roast probe .....  | 117 |
| Using the roast probe.....   | 119 |
| Time-left display.....   | 119 |
| Residual heat utilization .....  | 120 |
| <b>Slow Roasting</b> .....   | 121 |
| Using “Slow Roasting” special mode .....   | 122 |
| Adjusting the Slow Roasting temperature.....   | 123 |
| <b>Broil</b> .....   | 124 |
| <b>Special Modes</b> .....   | 126 |
| Defrost.....   | 127 |
| Dehydrate.....   | 127 |
| Reheat .....   | 128 |
| Warm-up Cookware .....   | 129 |
| Proof.....   | 129 |
| Pizza.....   | 129 |
| Sabbath Program .....  | 130 |
| Gentle Bake.....   | 131 |
| Canning.....   | 132 |
| Frozen food.....   | 133 |
| <b>Cleaning and care</b> .....   | 134 |
| Unsuitable cleaning agents.....  | 134 |
| Tips.....  | 135 |
| Normal soiling.....  | 135 |
| Wireless Roast Probe .....   | 135 |
| Stubborn soiling .....   | 136 |
| Cleaning the oven interior with Self Clean  ..... | 137 |
| Preparing for the Self Clean program.....  | 137 |
| Starting the Self Clean program .....  | 138 |
| Starting the Self Clean program .....  | 138 |

# Contents

---

|   |            |
|---|------------|
| Delaying the start of the Self Clean program .....  | 138        |
| At the end of the Self Clean program .....          | 139        |
| If the Self Clean program is cancelled.....         | 140        |
| Door removal .....                                  | 141        |
| Reinstalling the door .....                         | 142        |
| Runner removal .....                                | 143        |
| <b>Frequently Asked Questions .....</b>             | <b>144</b> |
| <b>Technical Service.....</b>                       | <b>150</b> |
| Contact in case of fault .....                      | 150        |
| Warranty .....                                      | 150        |
| <b>Caring for the environment .....</b>             | <b>151</b> |
| <b>Plumbing .....</b>                               | <b>152</b> |
| Notes on connecting to the water supply .....       | 152        |
| Attaching the stainless steel hose to the oven..... | 153        |
| Connecting to the water supply .....                | 153        |
| <b>Electrical connection .....</b>                  | <b>154</b> |
| <b>Installation diagrams.....</b>                   | <b>155</b> |
| Appliance and cut-out dimensions .....              | 155        |
| Undercounter installation .....                     | 155        |
| Installation in a tall cabinet.....                 | 156        |
| <b>Installing the oven .....</b>                    | <b>157</b> |
| <b>Copyright and licenses .....</b>                 | <b>158</b> |

# IMPORTANT SAFETY INSTRUCTIONS

---

When using the appliance, follow basic safety precautions, including the following:

**Read all instructions before installation and use of the oven to prevent accidents and machine damage.**

This appliance complies with current safety requirements. Improper use of the appliance can lead to personal injury and material damage.

Read all instructions before installing or using the oven for the first time. Only use the appliance for its intended purpose.

Keep these operating instructions in a safe place and pass them on to any future user.

## Appropriate use

- ▶ This appliance is intended for residential use only. Use only as described in these operating instructions.
- ▶ This appliance is not intended for outdoor use.
- ▶ Only use this oven for residential cooking, and the purposes described in this manual. Other uses are not permitted and can be dangerous.
- ▶ Risk of Fire! Do not use this oven to store or dry flammable materials.
- ▶ Persons who lack physical, sensory or mental abilities, or experience with the appliance should not use it without supervision or instruction by a responsible person.

## Safety with children

- ▶ Children should not be left alone or unattended in an area where an oven is in use. Never allow children to operate, sit or stand on any part of the oven. **Caution:** Do not store items of interest to children in cabinets above an oven. Children climbing on the oven to reach these items could be injured.



# IMPORTANT SAFETY INSTRUCTIONS

---

- ▶ **Burn Hazard** - Do not allow children to use the oven. Failure to do so can result in severe burns or serious injury.
- ▶ **Danger of suffocation!** Ensure that any plastic wrappings, bags, etc. are disposed of safely and kept out of the reach of children.
- ▶ **Danger of burns.** The oven gets hot at the oven door glass, the vapor vent, the handle and the operating controls. Do not allow children to touch or play in, on or near the oven.
- ▶ **Danger of burns.**  
Children's skin is more sensitive to high temperatures than that of adults. The oven becomes hotter during self-cleaning than it does in normal use. Do not let children touch the oven while the Self Clean program is running.

## **Technical safety**

- ▶ This appliance must be installed and connected in compliance with the installation instructions.
- ▶ Unauthorized installation, maintenance, and repairs can cause considerable danger for the user. Installation, maintenance, and repairs must only be carried out by a Miele authorized technician.
- ▶ Changes or modifications not expressly approved by Miele may void the user's authority to operate the oven.
- ▶ **Maintenance by the user:** Never repair or replace any part of the appliance unless the instructions specifically recommend doing so. Service work should only be performed by a qualified technician.
- ▶ Before installing the oven, check for externally visible damage. Do not operate a damaged appliance.
- ▶ Reliable and safe operation of the oven can only be guaranteed if it is connected to the power supply.

## IMPORTANT SAFETY INSTRUCTIONS

---

- ▶ To guarantee the electrical safety of this appliance, continuity must exist between the appliance and an effective grounding system. This appliance must be grounded. Connect only to properly grounded outlet. See “Electrical connection - GROUNDING INSTRUCTIONS”. It is imperative that this basic safety requirement be met. If there is any doubt, have the electrical system of the house checked by a qualified electrician.
- ▶ Proper installation: Make sure that your appliance has been installed correctly and that it has been grounded by a qualified technician.
- ▶ Before installation, make sure that the voltage and frequency listed on the data plate correspond with the household electrical supply. This data must correspond to prevent injury and machine damage. Consult a qualified electrician if in doubt.
- ▶ Before installation or service, disconnect the power supply to the work area by
  - removing the fuse,
  - “tripping” the circuit breaker, or
  - unplugging the unit. Pull the plug not the cord.
- ▶ Extension cords do not guarantee the required safety of the appliance (e.g. danger of overheating). Do not use an extension cord to connect this appliance to electricity.
- ▶ The oven is not to be operated until it has been properly installed within cabinetry.
- ▶ Danger of electric shock!  
Under no circumstances open the outer casing of the appliance.
- ▶ This appliance must not be used in a non-stationary location (e.g. on a ship).

## IMPORTANT SAFETY INSTRUCTIONS

---

- ▶ Do not repair or replace any part of the appliance unless specifically recommended in the operating instructions. All other servicing should be referred to a qualified technician.
- ▶ Defective components should be replaced by Miele original parts only. Only with these parts can safety of the appliance be assured as intended by the manufacturer.
- ▶ In order for the oven to function correctly, it requires an adequate supply of cool air. Ensure that the air flow is not impaired (e.g. insulation in the cabinetry). Also be sure that the cool air supply is not heated by other sources nearby.
- ▶ If the oven is installed behind a cabinet door, do not close the door while the oven is in operation. Heat and moisture can build up behind the closed door and cause damage to the oven, cabinetry and flooring. Do not close the door until the oven has completely cooled down.
- ▶ The water intake valve must be installed in an area accessible after installation.
- ▶ The protective sleeve of the water intake hose must not be damaged or become kinked. This will cause it to leak.
- ▶ The integrated Waterproof System offers protection from water damage, provided the following conditions are met:
  - The oven is properly installed (electric and water).
  - A damaged appliance is dangerous. Contact Miele for repair immediately.
  - The water supply has been turned off when the appliance is not going to be used for a longer period of time (e.g. vacation).
- ▶ Water containing lime or minerals as well as water from reverse osmosis units may damage the oven. The water from your water supply should therefore be filtered and free of lime and minerals.

# IMPORTANT SAFETY INSTRUCTIONS

---

## Correct use

 The oven becomes very hot while in use. Use caution to ensure that you are not burned on the heating elements or interior surfaces of the oven. Use pot holders when placing food in the oven, adjusting the racks, etc. in a hot oven.

- ▶ Caution: Heating elements may be hot even though they are not glowing. Interior surfaces of an oven become hot enough to cause burns. External parts of the oven such as the door glass, vents, and the control panel can become hot. During and after use, do not touch, or let clothing or other flammable materials come into contact with heating elements or interior surfaces of the oven until they have had sufficient time to cool.
- ▶ Do not let food sit in the oven for an extended period of time before or after cooking. Doing so can result in food poisoning or sickness.
- ▶ It is important that the heat is evenly distributed throughout the food being cooked. This can be achieved by stirring and/or turning the food.
- ▶ Use only dry, heat-resistant potholders. Moist or damp potholders used on hot surfaces may result in steam burns. Do not let potholders come in contact with oil or grease. Do not substitute dish towels or other bulky items for potholders. Do not let potholders touch hot heating elements.
- ▶ Loose fitting or hanging garments present a fire hazard. Wear proper apparel while operating the appliance.
- ▶ Do not heat unopened containers of food in the oven, pressure may cause the containers to burst and result in injury.
- ▶ Never pour cold water onto hot surfaces in a hot oven. The steam created could cause serious burns or scalding and the sudden change in temperature can damage the enamel in the oven.

## IMPORTANT SAFETY INSTRUCTIONS

- ▶ During cooking processes using moisture and during the residual moisture evaporation process steam is produced which can cause serious injury by scalding. Do not open the door while a burst of steam is being released or during the evaporation process.
- ▶ To prevent burns, always place oven racks at their desired height while the oven is cool. If the rack must be moved while the oven is hot, do not let pot holders touch hot heating elements.
- ▶ Open the door carefully to allow hot air or steam to escape before placing or removing food.
- ▶ To prevent burns, allow the heating elements to cool before cleaning by hand.
- ▶ Do not leave the oven door open unnecessarily as someone may trip over it or be injured by it.
- ▶ Never leave the appliance unattended when cooking with oil or fat. They can ignite if overheated. Do not use water on grease fires. Turn off the oven immediately and suffocate the flames by keeping the oven door closed.
- ▶ Smother the fire or flames, or use a dry chemical extinguishing agent or foam fire extinguisher.
- ▶ Never store flammable liquids and materials in, above or under an oven, or near cooking surfaces.
- ▶ Do not use the oven to heat the room. The high temperatures radiated could cause objects near the oven to catch fire.



### WARNING

NEVER use this appliance as a space heater to heat or warm the room. Doing so may result in carbon monoxide poisoning and overheating of the oven.





### WARNING

NEVER use this appliance as storage space. Doing so may result in carbon monoxide poisoning and overheating of the oven.

## IMPORTANT SAFETY INSTRUCTIONS

### WARNING

NEVER cover any slots, holes or passages in the oven bottom or cover an entire rack with materials such as aluminum foil. Doing so blocks air flow through the oven and may cause carbon monoxide poisoning. Aluminum foil linings may also trap heat, causing a fire hazard.

- ▶ Broiling food for an excessively long time can cause it to dry out and may result in the food catching fire.  
Do not exceed recommended broiling times.
- ▶ Some foods dry out very quickly and can be ignited by high broiling temperatures. Do not use broiling modes for crisping rolls or bread, or to dry flowers or herbs. Instead use the Convection Bake  or Surround  modes.
- ▶ Use caution when using alcohol in your recipes. Alcohol evaporates at high temperatures but may, in rare circumstances, combust on the hot heating elements.
- ▶ Plastic containers, which are not heat-resistant, melt and may ignite at high temperatures and can damage the oven. Use only plastic containers that are indicated by the manufacturer as being suitable for use in ovens.
- ▶ When residual heat is used to keep food warm, the high level of humidity and condensation can cause damage in the oven. The control panel, countertop or cabinetry may also be damaged. Do not switch the oven off completely while food is inside it, but select the lowest possible temperature for the oven mode you are using. This will ensure the fan will automatically continue to run.
- ▶ It is recommended to cover all cooked food that is left in the oven to be kept warm. This will prevent moisture from condensing on the interior of the oven.
- ▶ To avoid damage, do not place aluminum foil, pots, pans or baking sheets directly on the oven floor. This can cause a build up of heat that will damage the oven floor.

## IMPORTANT SAFETY INSTRUCTIONS

---

- ▶ Do not slide pots or pans on the oven floor. This could scratch and damage the surface.
- ▶ The door can support a maximum weight of 33 lbs (15 kg). Do not sit on or lean against an open door, and do not place heavy objects on it. Also make sure that nothing can get trapped between the door and the oven cavity. The oven could get damaged.
- ▶ This oven must only be used for cooking food. Fumes, vapors or heat given off by glues, plastics or flammable liquids and materials could be hazardous. Do not use it as a dryer, kiln, dehumidifier, etc.
- ▶ Do not obstruct the flow of combustion and ventilation air.
- ▶ Do not let metal objects (aluminum foil, pans) come in contact with the heating element.
- ▶ Make certain that the power cords of small appliances do not come in contact with or get caught in the oven door.
- ▶ When baking frozen pizzas or pies, place them on the wire rack lined with parchment paper. Do not use the baking tray or the roasting pan for frozen foods with a large surface area. The tray or pan could become warped and difficult to remove from the oven when hot. Frozen foods like french fries, chicken nuggets, etc. can be baked on the baking tray.
- ▶ The wireless roast probe antenna on the top right of the oven interior is at risk of damage when sliding in accessories. When sliding in accessories, take care not to bang them against the wireless roast probe.
- ▶ The wireless roast probe antenna on the top right of the oven interior is at risk of damage when sliding the FlexiClips with wire rack in at level 6. Only use the FlexiClips with wire rack at levels 1 to 5.

# IMPORTANT SAFETY INSTRUCTIONS

---

## Cleaning and maintenance

- ▶ Do not use a steam cleaner to clean this oven. Steam could penetrate electrical components and cause a short circuit.
- ▶ Only clean parts listed in these Operating and Installation Instructions.
- ▶ Scratches on the door glass can cause the glass to break. Do not use abrasive cleaners, hard sponges, brushes or sharp metal tools to clean the door glass.
- ▶ The shelf runners can be removed for cleaning purposes (see “Cleaning and care”). Ensure they are correctly fitted after cleaning and never operate the oven without the shelf runners inserted.
- ▶ There is a seal around the oven interior which seals the inside of the door. Take care not to rub, damage or move the gasket. Do not clean the door gasket - the door gasket is essential for a good seal.
- ▶ Do not use a protective coating to line the oven and do not use commercial oven cleaner unless certified for use in a self-cleaning oven.
- ▶ Debris should be removed before running the Self Clean program. If not removed this debris can smoke causing the self-cleaning program to turn itself off.

## Accessories

- ▶ Use only genuine original Miele parts. If parts or accessories from other manufacturers are used, the warranty will become void.
- ▶ Only use the Miele roast probe supplied with this oven. If it is faulty, it must only be replaced with a Miele genuine roast probe.
- ▶ The plastic on the roast probe can melt at very high temperatures. Do not use the roast probe when using the broil functions (exception: Convection Broil ). Do not store the roast probe in the oven if it is not in use.



## IMPORTANT SAFETY INSTRUCTIONS

---

▶ This oven complies with Industry Canada licence-exempt RSS standard(s) and part 15 of the FCC Rules. Operation is subject to the following two conditions: (1) This device may not cause harmful interference, and (2) this device must accept any interference received, including interference that may cause undesired operation.

▶ The high temperatures used during self-cleaning will damage accessories that are not designed for cleaning in the Self Clean program. Please remove these accessories from the oven before starting the Self Clean program. This also applies to accessories purchased separately (see “Cleaning and care”).

### **Preparing your appliance for an extended vacation**

▶ If you elect to turn off the water to your home for an extended period of time, please note that this may not be enough to reduce the risk of a leak. To be completely safe, you must turn off the water supply to each individual appliance.

**SAVE THESE INSTRUCTIONS AND REVIEW THEM PERIODICALLY**

# Guide to the oven

---

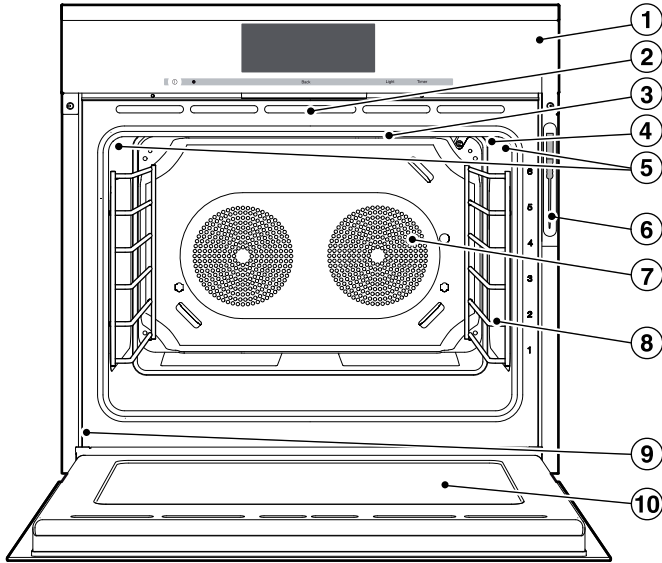

- ① Control panel
- ② Door with contact switch\* and lock for Self Clean program
- ③ Browning/Broiling element
- ④ Wireless roast probe antenna
- ⑤ Oven interior lighting
- ⑥ Wireless roast probe
- ⑦ TwinPower convection fan with heating element
- ⑧ Side runners with 6 shelf levels
- ⑨ Data plate
- ⑩ Door

\* This switch ensures that the heating elements and the convection fans turn off when the door is opened during use.

# Control panel

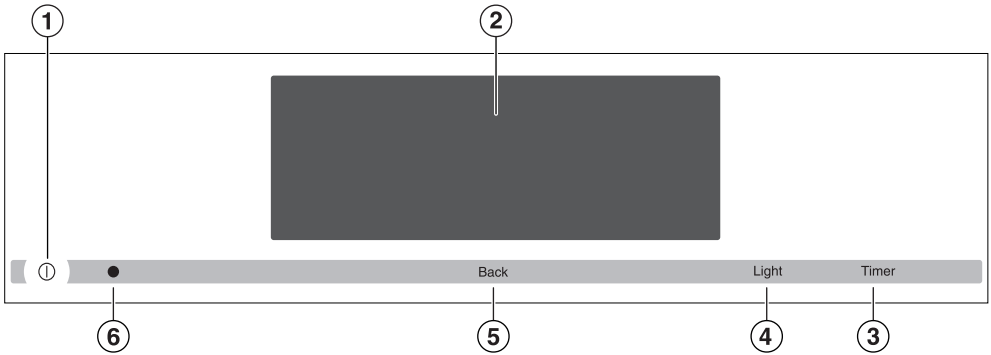

- ① On/Off ① button  
Turns the oven on and off
- ② Display  
Displays the time of day and information on operation
- ③ “Timer” sensor button  
To set the timer
- ④ “Light” sensor button  
To turn the oven cavity lighting on and off
- ⑤ “Back” sensor button  
To go back one step at a time
- ⑥ Optical interface  
(for service technician use only)

# Control panel

---

## Sensor buttons

The sensors react to touch. Each touch is confirmed with an audible tone. This tone can be turned off (see “Settings – Volume - Keypad tone”).

| Sensor button | Function  | Notes  |
|---------------|---|--|
| Timer         | For activating and deactivating timer / alarm   | If a menu appears in the display or if cooking is in progress, you can enter a timer duration (e.g. when boiling eggs on the cooktop) or an alarm time, i.e. a specific time, at any point (see “Alarm + Timer”).<br>If the display is turned off, the “Timer” button will not react until the oven is turned on.  |
| Light         | For turning the oven cavity lighting on and off | If a menu appears in the display or if a cooking procedure is in progress, tapping the “Light” button will turn the oven cavity light on or off.<br>If the display is turned off, the “Light” button will not react until the oven is turned on.<br>The oven cavity lighting turns off after 15 seconds during cooking or remains constantly turned on, depending on the setting selected. |
| Back          | To go back a step                               |  |

## M Touch display

The touch screen can be scratched by hard objects, e.g. pens and pencils. Only touch the display with your fingers.

Touching the display with your finger emits a small electrical charge, which in turn triggers an electrical pulse that is detected by the surface of the touch display.

The display is divided into three sections:

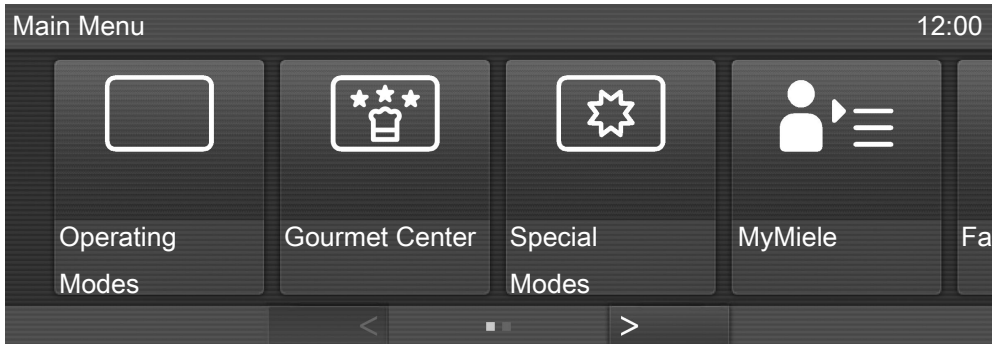

The top line shows what menu level you are currently in. Options within a menu are separated by a vertical line. If there is not enough space to show the whole path, additional options are indicated by ... I. The Time of Day, Alarm ⌚ and Timer ⏰ are shown in the top right-hand corner of the display.

The middle row shows the current menu and options. You can scroll to the right or left by swiping your finger across the display.







The < and > arrows at the bottom of the screen are used for scrolling to the left or right. The number of small squares between the arrows indicates the number of pages available and your position within the current menu.

# Control panel

---

## Symbols

The following symbols may appear in the display:

| Symbol  | Description   |
|---|---|
|  | Some settings, e.g. display brightness and buzzer volume, are selected using a bar chart.   |
|  | This symbol indicates that there is additional information and advice about using the oven. Select <i>OK</i> to access the information. |
|  | The system lock or sensor lock is active (see “Settings – Safety”). The oven cannot be used.  |
|  | Alarm   |
|  | Timer   |
|  | Core temperature when using the roast probe   |

## Using the appliance

Whenever you touch a possible option the relevant field will light up orange.

### To select or open a menu

- Touch the desired field to select it.

### Scrolling

You can scroll left or right.

- Swipe the screen, i.e., place your finger on the touch display and move it in the desired direction.
- Or: touch the < and > arrows with your finger to scroll left or right.

### Exiting a menu

- Touch “Back”, select an option in the menu path at the top of the screen, or touch ... I.

Depending on the current menu, this will take you back one level or return you to the Main Menu.

### Help function

With some functions and options Help appears.

- Select the function.

Helpful information will then appear in text and pictures.

# Control panel

---

## Entering numbers

You can enter numbers by scrolling through and touching the roller, or by using the numeric keypad.

### To enter numbers using the roller:

- Swipe the roller up or down to select the desired number.

### To enter numbers using the numeric keypad:

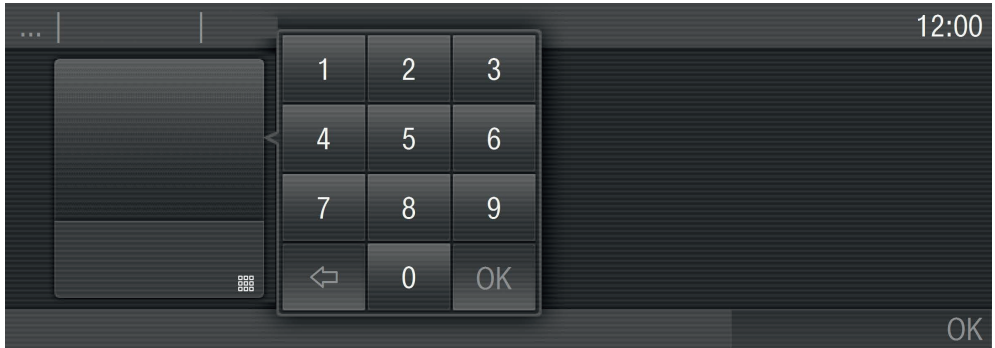

- Touch  in the bottom right of the input field.

The numeric keypad appears.

- Touch the required numbers.

Once you have entered an accepted value, the *OK* field will light up green. Use the arrow to delete the last entered number.

- Touch *OK*.

## Entering letters

Names are entered using a keyboard. It is best to select short, concise names.

- Select the required letters or characters.
- Touch *Save*.



## Model numbers

A list of the ovens described in these operating instructions can be found on the back page.

## Data plate

The data plate located on the front frame of the oven is visible when the door is open.

Printed on the data plate are the model number, serial number and the connection data (voltage/frequency/maximum rated load) of the oven.

Have this information available when contacting Miele Technical Service.

## Items included

The following items are included with this appliance:

- the Operating and Installation Instructions,
- screws for securing your appliance into the cabinetry, and
- various accessories.

## Standard and optional accessories

Accessories vary depending on model. **All ovens are supplied with shelf runners, a universal tray and a wire oven rack.** Depending on the model, your oven may also come with the additional accessories listed.

All accessories and cleaning and care products in these instructions are designed to be used with Miele ovens.

These can be ordered from the Miele web store, Miele Technical Service, or from your Miele dealer.

When ordering, please have ready the model number of your oven and of the desired accessories.

### Shelf runners

The shelf runners are located on the right and left-hand sides of the oven with the levels for inserting accessories.

The shelf level numbers are indicated on the front of the oven frame.

Each level consists of a strut on which you can place the wire oven rack, for example.

The runners can be removed. See “Cleaning and Care”.

# Features

## Universal tray and wire oven rack with anti-tip safety notches

The wireless roast probe antenna on the top right of the oven interior is at risk of damage when sliding in accessories.

When sliding in accessories, take care not to bang them against the wireless roast probe.

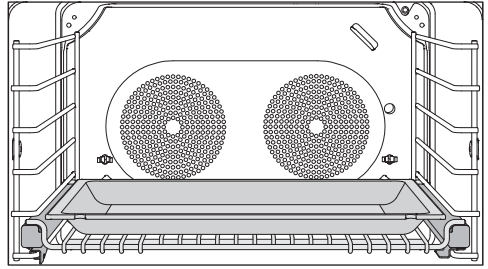

You can also place the universal tray directly on the FlexiClips with wire rack.

Universal tray HUBB 30-1:

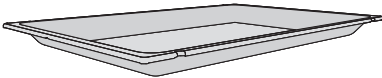

Wire oven rack HBBR 30-2:

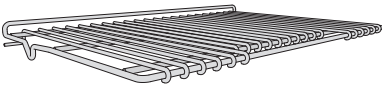

Safety notches are located on the short edges of the wire oven rack. These prevent the wire oven rack from being fully pulled out of the side runners when they only need to be pulled partially out.

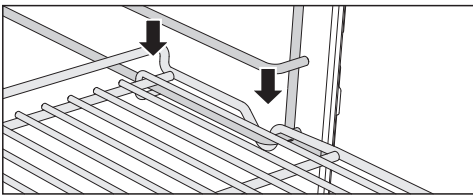

Always slide the wire oven rack into the rails on the shelf runner with the catches facing down.

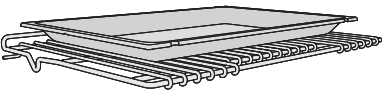

When using the universal tray, place it directly on the wire oven rack.

## FlexiClips with wire rack HFCBBR 30-2

The wireless roast probe antenna on the top right of the oven interior is at risk of damage when sliding the FlexiClips with wire rack in at level 6. Only use the FlexiClips with wire rack at levels 1 to 5.

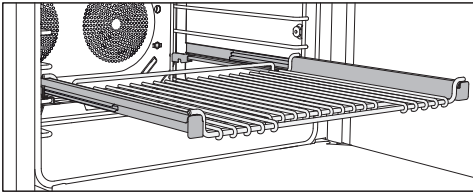

The FlexiClips with wire rack can be pulled completely out of the oven. This allows you to see the food easily.

The FlexiClips with wire rack are pushed onto the rails of a level and then locked into place.

The FlexiClips can support a maximum load of 33 lb (15 kg).

## Installing and removing the FlexiClips with wire rack

 **Danger of burning!**

The heater elements must be turned off. Make sure the oven has cooled down.

When installing the FlexiClips, **do not** extend them.

- Hold the FlexiClips with wire rack with both hands and position it in front of the desired level.

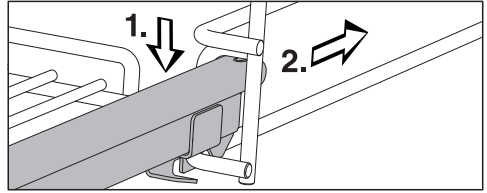

- Insert the FlexiClips with wire rack onto the level (1.) and slide it along the struts of the level (2.) until it clicks into place.

If the FlexiClips with wire rack jams when sliding it onto the level, pull it out using some force and reinsert.

To remove the FlexiClips with wire rack:

- Push the FlexiClips with wire rack in all the way.

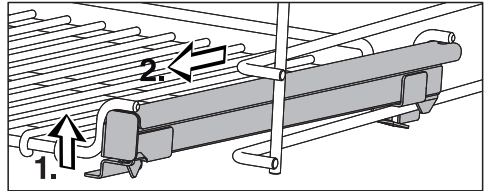

- Using both hands lift the front of the FlexiClips with wire rack on both sides (1.) and pull it out of the level (2.).

## Using the universal tray

- When using the universal tray, place it directly on the FlexiClips with wire rack.

## Features

---

### Perforated Gourmet baking tray HBBL 71

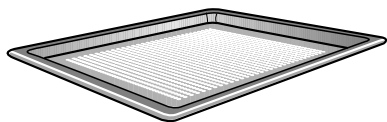

The perforated Gourmet baking tray has been specially developed for the preparation of baked goods made from fresh yeast and quark doughs.

The tiny perforations assist in browning the underside of baked goods.

The tray can also be used for dehydrating or drying food.

The enameled surface has been treated with PerfectClean.

The **round perforated baking tray HBFP 27-1** can be used for the same things.

The perforated baking tray can be placed on the rack.

### Grilling and Roasting insert HGBB 30-1

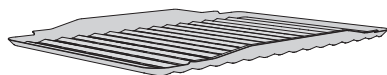

The grilling and roasting insert is placed in the universal tray.

The drippings from the meat or poultry are collected under the insert reducing spattering in the oven. The drippings can then be used for gravy and sauces.

The surface has been treated with PerfectClean enamel for easy cleaning.

### Round baking form HBF 27-1



This circular form is suitable for cooking fresh or frozen pizzas, flat cakes, tarts and baked goods.

The surface has been treated with PerfectClean enamel.

### Gourmet Baking Stone HBS 60

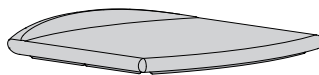

The baking stone is ideal for baking dishes with a crisp bottom such as pizza and bread.

The baking stone is made from a heat retaining stone and is glazed. Place the stone directly on the wire rack.

A wooden peel is supplied with it for placing food on and off the stone.

## HUB Gourmet casserole dishes HBD casserole dish lids

Miele Gourmet casserole dishes can be placed directly on the wire oven rack. The surface of the casserole dishes has a non-stick coating.

Gourmet casserole dishes are available in different depths. The width and the height are the same.

Suitable lids are available separately. Please quote the model number when ordering.

**Depth:**  
**8 1/2" (22 cm)**

HUB 62-22 \*

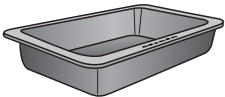

HBD 60-22

**Depth:**  
**13 3/4" (35 cm)**

HUB 62-35 \*

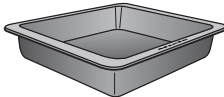

HBD 60-35

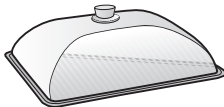
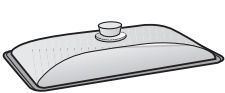

\* Suitable for use on induction cooktops

## Roast probe

(Wireless Precision Probe)

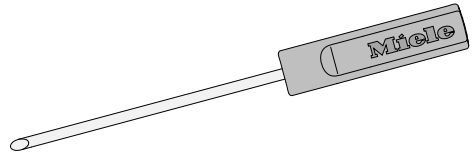

The wireless roast probe allows you to accurately monitor the food's internal temperature during the cooking process (see "Roast - Roast probe"). The roast probe is stored in a storage sleeve in the front frame when not in use.

# Features

---

## Opener

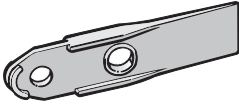

The opener allows you to open the cover of the oven light.

## Miele Oven Cleaner

Miele oven cleaner is suitable for removing stubborn soiling. It is not necessary to preheat the oven before use.

## Oven controls

The oven controls allow you to use the various cooking modes to bake, roast and broil.

It also allows you to access:

- the time of day display,
- a timer,
- a timer to automatically turn cooking programs on and off,
- Moisture Plus cooking,
- the MasterChef programs,
- the MasterChef + programs,
- the creating of a Favorite program,
- settings that can be customized.

## Oven safety features

### System lock

The system lock prevents the oven from being used unintentionally (see “Settings - System lock”).

The system lock will remain activated even after a power failure.

### Sensor lock for the oven

The sensor button lock prevents you from accidentally turning the oven off or changing a cooking program (see “Settings – Safety – Sensor lock”).

### Safety shut-off

The oven automatically turns itself off if it is used for an exceedingly long period. The length of time depends on the oven mode being used.

## Cooling fan

The cooling fan comes on automatically when a cooking program is started. The cooling fan mixes hot air from the oven cavity with cool room air before venting it out into the kitchen through vents located between the appliance door and the control panel.

The cooling fan will continue to run for a while after a program is complete to prevent moisture from building up in the oven, on the control panel or surrounding cabinetry.

When the temperature in the oven has fallen sufficiently, the cooling fan will turn off automatically.

## Vented oven door

The oven door is made of glass panes that have a heat-reflective coating on part of their surface.

During operation, air is also circulated through the door to keep the outer panel cool.

The door can be removed and disassembled for cleaning purposes (see “Cleaning and care”).

## Safety Door Lock for Self Clean

For safety reasons, the door is locked as soon as the Self Clean program is started. After the self-cleaning program has finished, the door will remain locked until the temperature in the oven has fallen below 535°F (280°C).

# Features

---

## PerfectClean surfaces

The revolutionary PerfectClean finish is a smooth, non-stick surface that is exceptionally easy to clean.

Food and grime from baking or roasting are easily removed.

Do not use ceramic knives, as these will scratch the PerfectClean surface.

Follow the instructions in the “Cleaning and Care” section of this manual so the anti-stick and easy cleaning properties are retained.

The following have all been treated with PerfectClean:

- Universal tray
- Grilling and Roasting insert
- Perforated baking tray
- Round baking form

## Self Clean ready accessories

The following accessories can be left in the oven during the Self Clean program.

- Shelf runners,
- FlexiClips with wire rack
- Wire oven rack

See “Cleaning and care” for more information.



## Standard settings

 The oven must not be operated until it has been properly installed within cabinetry.

The oven will turn on automatically when it is connected to the power supply.

## Welcome screen

A welcome greeting is displayed. You will then be asked to select some basic settings which are needed before the appliance can be used.

- Follow the instructions on the display.

## Setting the language

- Select the desired language.
- Confirm with *OK*.

## Setting the country

- Select the desired country.
- Confirm with *OK*.

## Setting the voltage (electrical version)

 The voltage set must match that of the house as to not damage the oven.

Confirm the voltage before setting. If in doubt contact a qualified technician.

- Select the voltage.
- Confirm with *OK*.

## Setting the date

You can enter numbers by scrolling through and touching the roller, or by using the numeric keypad.

- Set the day, then the month, and finally the year.
- Confirm with *OK*.

# Before first use

---

## Setting the time of day

You can enter numbers by scrolling through and touching the roller, or by using the numeric keypad.

- Set the time of day in hours and minutes.
- Confirm with *OK*.

The time of day can be displayed in 12-hour format (see “Settings – Time of Day – Clock Format”).

## Time display

You will then be asked how you want the time of day to show in the display when the oven is turned off (see “Settings – Time of day – Display”).

- On

The time is always visible in the display.

- Off

The display appears dark to save energy. Some modes are limited.

- Night Dimming

The time only shows in the display between 5:00 am and 11:00 pm. It turns off at night to save energy.

- Select the desired option.
- Confirm with *OK*.

Information regarding energy consumption will appear in the display.

- Confirm with *OK*.
- Follow any further instructions in the display.

Set-up Successfully Completed is displayed.

- Confirm with *OK*.

The oven is now ready to use.

If you accidentally select the wrong language, follow the instructions described in “Settings – Language ”.

### Heating up the oven for the first time and rinsing the steam injection system

New ovens may have a slight odor during their first use. Heating up the oven for at least an hour with nothing in it will eliminate the odor. It is a good idea to rinse out the steam injection system at the same time.

Ensure that the kitchen is well ventilated while the appliance is being heated up for the first time. Close doors to other rooms to prevent the odor spreading throughout the house.

- Remove any adhesive labels or protective films from the ovens and accessories.
- Before heating the oven up, wipe the cavity with a damp cloth to remove any dust or bits of packaging that may have accumulated in the oven cavity during storage and unpacking.
- Insert the FlexiClip telescopic runners (available to order) to the shelf runners and insert all trays and the rack.
- Turn on the oven.

The main menu will appear.

- Select Operating Modes .
- Select Moisture Plus .

The default temperature is displayed (350 °F/160 °C).

The oven heating, lighting and cooling fan will turn on.

- Set the highest possible temperature (475 °F/250 °C).
- Confirm with OK.
- Select Automatic burst of steam.

After a short time, a burst of steam is injected automatically.

 Risk of injury!  
Steam can cause scalding.  
Do not open the door during a steam burst.

Heat up the oven for at least an hour.

After at least one hour:

- Turn the oven off.

### After heating up for the first time

 Danger of burns! Allow the oven to cool before cleaning.

- Turn on the oven.
- Select Light to turn on the oven light.
- Take all accessories out of the oven and clean them by hand (see “Cleaning and care”).
- Clean the oven interior with warm water and liquid dish soap, applied with a soft sponge or cloth.
- Dry all surfaces with a soft cloth.
- Turn the lighting and the oven off.

Leave the oven door open until the oven interior is completely dry.

# Settings

---

## Accessing the “Settings” menu

From the main menu.

- Select  Settings.

The settings can now be checked or changed.

Settings cannot be altered while a cooking program is in progress.

## Changing and saving settings



- Select  Settings.
- Swipe across the screen until the desired setting appears, then touch it to select.

The settings which are currently selected will have a colored frame around them.

- Swipe across the screen until the desired option appears, then touch it to select it.
- Confirm with *OK*.

The setting is now saved.

## Settings overview

| Option   | Available settings  |
|--|---|
| Language  | ... / deutsch / english / ...<br>Country  |
| Time   | Display<br>On / Off * / Night Dimming<br>Clock Type<br>Analog * / Digital<br>Clock Format<br>24 h / 12 h (am/pm) *<br>Set |
| Date   |   |
| Lighting   | On / On for 15 seconds *  |
| Start Screen   | Main Menu<br>Operating Modes<br>Gourmet Center<br>Special Modes<br>MyMiele<br>Favorites                                   |
| Brightness   |    |
| Volume   | Buzzer Tones<br>Keypad Tone<br>Welcome Melody   |
| Units of Measurement   | Weight<br>g / lb / lb/oz *<br>Temperature<br>°C / °F *  |
| Cooling Fan  | Time Controlled<br>Temperature Controlled *   |

\* Factory default

# Settings



| Option                   | Available settings   |
|--------------------------|--|
| Self Clean               | With reminder<br>Without reminder *  |
| Recommended temperatures |  |
| Safety                   | System Lock <br>On / Off *<br>Sensor Lock<br>On / Off * |
| Catalyzer                | ■■■■■  |
| Electrical Version       | 208V / 60Hz<br>220V / 60Hz<br>240V / 60Hz  |
| Sensor group             | <b>If you have purchased a new Miele roast probe you must enter a 12-digit code for this setting.</b>                                    |
| Calibrate Temperature    | ■■■■■  |
| Showroom Program         | Demo Mode<br>On / Off *  |
| Factory Default          | Settings<br>Favorites<br>Recommended temperatures<br>MyMiele   |

\* Factory default

## Language

The desired country and language can be set.





After selecting and confirming your choice, the language selected will appear in the display.

**Tip:** If you accidentally select a language you do not understand, select  Settings and use the  symbol to return to the Language  submenu.

## Time of day

### Display

Select how you want the time of day to show in the display when the oven is switched off:

- On  
The time is always visible in the display. You can use the sensor buttons shown directly to turn the lighting  on and off or use the Alarm + Timer  functions.
- Off  
The display appears dark to save energy. The oven has to be turned on before you can use it. This also applies to using the Alarm + Timer  and lighting  functions.
- Night Dimming  
To save energy, the time only shows in the display between 5:00 a.m. and 11:00 p.m. The rest of the time the display is dark. The oven has to be turned on before you can use it.

### Clock type

You can choose from an analog clock face or a digital (h:min) display.

The date will also appear in the digital clock display.

### Clock format

You can select the clock format for the time of day:

- 24 h  
The time of day is shown in 24-hour clock format.
- 12 h (am/pm)  
The time of day is shown in 12-hour clock format.

### Set

Set the hours and the minutes.

If there is a power failure, the current time of day will reappear once the power has been restored. The time is stored in memory for about 200 hours.

### Synchronize

This menu item only appears if you are connected to the Miele@Home system (see separate instructions).

# Settings

---

## Date

Set the date.

When the oven is turned off, the date only appears if the oven is set to “Time – Clock Type – Digital”.

## Lighting

- On  
The interior lighting is switched on during the entire cooking period.
- On for 15 seconds  
The oven lighting switches off 15 seconds after a program starts. Touching  switches it on for another 15 seconds.

## Start screen

The oven is factory-set for the main menu to appear when the oven is turned on. You can change this default setting so that, for instance, the oven modes or MyMiele settings appear in the display (see “MyMiele”).

## Brightness

The display brightness is represented by a bar with seven segments.



- Select **Darker** or **Lighter** to change the brightness of the display.



## Volume

### Buzzer tones

The volume is represented by a bar with seven segments.



Maximum volume is selected when all segments are filled. If none of the segments are filled, the volume is switched off.

- Select **Quieter** or **Louder**, to adjust the volume.
- Select **On** or **Off** to switch the buzzer tones on or off.

### Keypad tone

The volume is represented by a bar with seven segments.



Maximum volume is selected when all segments are filled. If none of the segments are filled, the volume is switched off.

- Select **Quieter** or **Louder**, to adjust the volume.
- Select **On** or **Off**, to switch the keypad tone on or off.

### Welcome melody

You can turn the welcome melody on or off. It sounds when the **On / Off** button  is touched.

## Units of measurement

### Weight

- **g**  
The weight of food in MasterChef programs is shown in grams.
- **lb**  
The weight of food in MasterChef programs is shown in pounds.
- **lb/oz**  
The weight of food in MasterChef programs is shown in pounds/ounces.

### Temperature

- **°C**  
The temperature is displayed in Celsius.
- **°F**  
The temperature is displayed Fahrenheit.

# Settings

---

## Cooling fan

The cooling fan will continue to run for a while after the oven has been switched off to prevent any humidity building up in the oven, on the control panel, or in the cabinet niche.

- Temperature Controlled  
The cooling fan switches off when the temperature in the oven drops below approx. 160°F (70°C).
- Time Controlled  
The cooling fan switches off after a period of about 25 minutes.

Condensation can damage the cabinet carcass and the countertop. This could lead to corrosion of the appliance.

When keeping food warm in the oven, increasing to the Time Controlled setting can lead to condensation of the control panel and moisture on the countertop and cabinetry.

Do not adjust the Time Controlled setting and try not to leave food in the warm oven.

## Recommended temperatures

If you often cook with temperatures that differ from the default, it makes sense to change the recommended temperatures.

After selecting this option, a list of oven modes will appear in the display.

- Select the desired mode.

The recommended temperature is displayed along with the available temperature range.

- Change the recommended temperature.
- Confirm with *OK*.

## Self Clean

- With reminder

A reminder to run the Self Clean program will appear in the display.

- Without reminder

You will not be reminded to run the Self Clean program.

## Safety

### System lock

The system lock prevents the oven being turned on inadvertently.

The system lock will remain activated even after a power failure.

Select **On** to activate the system lock.

The alarm and timer can still be set when the system lock is active.

- **On**

The system lock is now active. If you want to use the oven, touch  for at least 6 seconds.

- **Off**

The system lock is now deactivated. You can use the oven as normal.

# Settings

---

## Sensor lock

The sensor lock prevents users from accidentally turning the oven off or changing a cooking program. Once activated, the sensor lock prevents the sensor buttons and fields in the display from working for a few seconds after a program has been started.

- On  
The sensor lock is active. Before you can use a mode, you must touch  for at least 6 seconds. The sensor lock is then deactivated for a short period.
- Off  
The sensor lock is not active. All sensor buttons react to touch as normal.

## Catalyzer

The level of odor reduction is represented by a bar with seven segments.



If all segments are illuminated, maximum odor reduction is selected. If none of the segments are illuminated, the catalyzer is turned off.

- Select **Minimum** or **Maximum** to change the level of odor reduction.
- Select **On** or **Off** to turn the catalyzer on and off.

## Voltage

Setting the voltage (electrical version)

- Select the desired voltage and corresponding frequency.
- Confirm with OK.

## Sensor group

The oven is factory-set to automatically detect the wireless roast probe.

If you have purchased a new Miele roast probe you must enter a 12-digit code for this setting. You can then start using the roast probe.

- Follow the description supplied with the replacement part.

## Calibrate temperature

Using temperature calibration the temperature can be modified, in all modes and Gourmet Center (oven) and MasterChef (speed oven) programs, so that it is slightly higher or lower than shown.

The temperature calibration is represented by a bar with seven segments.



If all of the segments are filled the oven temperature is much higher than indicated in the display. If no segment is filled the oven temperature is much lower than indicated.

- Select + or —, to adjust the temperature calibration.
- Confirm with OK.

# Settings

---

## Showroom program

This function enables the oven to be demonstrated in showrooms without heating up. Do not activate this setting for domestic use.



### Demo mode

**If you have demo mode activated**  
Demo Mode active. The appliance will not heat up **will appear** when you turn on the oven.

- On  
Touch *OK* for at least 4 seconds to activate demo mode.
- Off  
Touch *OK* for at least 4 seconds to deactivate demo mode. You can use the oven as normal.

## Factory default settings

- Settings  
Any settings that have been altered will be reset to the factory default setting.
- Favorites  
All Favorites will be deleted.
- Recommended temperatures  
Any recommended temperatures that have been changed will reset to the factory default settings.
- MyMiele  
All MyMiele entries will be deleted.

You can personalize your oven using the MyMiele   function by inputting frequently used processes.

It is particularly useful with the MasterChef automatic program/ MasterChef Plus automatic program as you do not need to work through every screen in order to start a program.





You can also set processes that you have entered into MyMiele to appear in the Start screen (see “Settings – Start screen”).

## To add an entry

You can add up to 20 entries.

- Select MyMiele.
- Select Add entry.

You can select options from the following categories:

- Operating Modes 
- Gourmet Center 
- Special Modes 
- Favorites 

- Confirm by touching OK.

The option selected appears in the list together with the corresponding symbol.



- Proceed as described above for any other entries. You will only be able to choose from options which have not already been selected.

## Editing MyMiele

After selecting Edit you can

- add entries, if MyMiele contains less than 20 entries,
- delete entries,
- sort entries, if MyMiele contains more than 4 entries.



## Deleting entries

- Select MyMiele  .
- Select Edit.
- Select Delete entry.
- Select the entry that you want to delete.
- Confirm with OK.

The entry will then be removed from the list.

## Sorting entries

If there are more than 4 entries, you can change the order of the entries.

- Select MyMiele  .
- Select Edit.
- Select Sort entry.
- Select the entry.
- Select the position you want to move it to.
- Confirm with OK.

The entry will now appear in the position selected.

# Alarm + Timer

---

Using the “Timer” button, you can set a timer for a duration (e.g. for boiling eggs) or an alarm (e.g., for a specific time).

Two alarms can be set simultaneously, two timer durations or an alarm and a kitchen timer duration.

## Using the alarm

The alarm can be used to set a specific time at which the buzzer will sound.

### Setting the alarm

If the Time – Display – Off setting is selected, you will need to turn the oven on before setting the alarm. The alarm time will then appear in the display when the oven is turned off.

- Select the “Timer” sensor button.
- Select New Alarm.
- Set the time for the alarm.
- Confirm with OK.

When the oven is switched off, the alarm time and  will appear instead of the time of day.

If you are cooking at the same time or if you are in a different menu, the alarm time and  will appear in the top right of the display.

### At the set alarm time:

- The  symbol flashes next to the time in the display.
- The buzzer will sound if it has been turned on (see “Settings – Volume – Buzzer tones”).
- Select the “Timer” sensor button or the alarm in the top right of the display.

The buzzer will stop and the symbols in the display will go out.

### Changing an alarm

- Select the alarm in the top right of the display or select the “Timer” sensor button and the desired alarm.

The alarm selected appears.

- Set the new time for the alarm.
- Confirm with OK.

The adjusted alarm time is now saved and will appear in the display.

### Deleting an alarm

- Select the alarm in the top right of the display or select the “Timer” sensor button and the desired alarm.

The alarm selected appears.

- Select Reset.
- Confirm with OK.

The alarm is deleted.



## Using the Timer

The timer can be used to time any activity in the kitchen, e.g. boiling eggs.

The timer can also be used at the same time as a cooking program if a start and finish time have been set, e.g. a reminder to stir the dish or add seasoning.

A maximum timer duration of 9 hours, 59 minutes and 59 seconds can be set.

**Tip:** Use the timer in Moisture Plus  to remind you to inject the bursts of steam at the desired time.

## Setting the timer

If the Time – Display – Off setting is selected, you will need to turn the oven on before setting the timer. The timer can then be seen counting down in the display when the oven is turned off.

Example: You want to boil some eggs and set a timer of 6 minutes and 20 seconds.

- Select the “Timer” sensor button.
- Select New Timer Time.
- Set the required timer duration.
- Confirm with OK.

When the oven is turned off, the timer duration counts down in the display and  appears instead of the time of day.

If you are cooking at the same time or if you are in a different menu, the timer duration and  will appear in the top right of the display.

# Alarm + Timer

---

## When the timer elapses:

- The  will flash.
- The time will count upwards.
- The buzzer will sound if it has been turned on (see “Settings – Volume – Buzzer tones”).
- Select the “Timer” sensor button or the timer in the top right of the display.

The buzzer will stop and the symbols in the display will go out.

## Changing the timer

- Select the timer in the top right of the display, or select the “Timer” sensor button and then the desired timer.

The set timer duration appears.

- Set a new timer duration.
- Confirm with OK.

The modified timer duration is saved and will count down in seconds.

## Deleting the timer

- Select the timer in the top right of the display, or select the “Timer” sensor button and then the desired timer.

The set timer duration appears.







- Select `Reset`.
- Confirm with OK.

The timer is deleted.







## Guide to the modes

The oven has a wide range of modes for preparing a variety of foods.



Due to country-specific preferences for preparation of food, default temperatures and temperature ranges in °F and °C do not correspond. The temperature values have been defined as given in the chart.

| Mode  | Default temperature | Temperature range          |
|---|---------------------|----------------------------|
| <b>Convection Bake</b> <br>Use this mode for baking and roasting on several levels at the same time. You can cook at lower temperatures than with the Surround  mode because the fan distributes the heat evenly throughout the cavity for a consistent baking temperature. | 350 °F (160 °C)     | 75–475 °F<br>(30–250 °C)   |
| <b>Surround</b> <br>This premium baking mode uses heat from the upper and lower elements to create perfect results on all baking recipes.  | 350 °F (180 °C)     | 75–525 °F<br>(30–280 °C)   |
| <b>Moisture Plus</b> <br>Infuse up to 3 bursts of moisture, either manually or time driven, throughout the cooking program to ensure a soft, moist interior with a crispy crust. MasterChef + programs use Moisture Plus during the cooking/baking process.  | 350 °F (160 °C)     | 275–475 °F<br>(130–250 °C) |
| <b>Intensive</b> <br>This mode gently circulates heated air from the lower heating element using the fan to create a brick oven environment. Ideal for baking pizza, focaccia, pies and tarts that require a crisp base and moist toppings.  | 400 °F (170 °C)     | 125–475 °F<br>(50–250 °C)  |
| <b>Auto Roast</b> <br>For a premium result, the meat is seared at a high temperature keeping meat tender and juicy.  | 375 °F (160 °C)     | 200–450 °F<br>(100–230 °C) |

## Guide to the modes

| Mode  | Default temperature | Temperature range          |
|---|---------------------|----------------------------|
| <b>Surround Roast</b> <br>For roasting traditional recipes, e.g. pot roast, and braising or cooking at low temperatures.   | 400 °F (180 °C)     | 75–525 °F<br>(30–280 °C)   |
| <b>Convection Roast</b> <br>This mode uses the convection fan to circulate heated air throughout the oven. Ideal for cooking delicate cuts of meat, fish and crispy poultry. | 375 °F (160 °C)     | 75–475 °F<br>(30–250 °C)   |
| <b>Bake</b> <br>This mode uses traditional baking techniques to perfect pies and biscuits.   | 375 °F (190 °C)     | 200–525 °F<br>(100–280 °C) |
| <b>Browning</b> <br>For a perfectly browned topping, for example when making a gratin or browning the top of a casserole.  | 350 °F (190 °C)     | 200–475 °F<br>(100–250 °C) |
| <b>Maxi Broil</b> <br>For broiling meats e.g. steak, chops, kebabs, etc. The entire Browning / Broiling element will glow red to produce the required heat.                  | 500 °F (240 °C)     | 400–575 °F<br>(200–300 °C) |
| <b>Broil</b> <br>For grilling smaller quantities of steak, chops, kebabs, etc.   | 500 °F (240 °C)     | 400–575 °F<br>(200–300 °C) |

## Guide to the modes

| Mode   | Default temperature | Temperature range          |
|--|---------------------|----------------------------|
| <p><b>Convection Broil</b> </p> <p>This mode distributes hot air from the Browning/ Broiling element over the food using the fan. This allows for a lower temperature to be used than when using Broil . Ideal for broiling thicker cuts of meat (e.g. chicken, roulades).</p> | 400 °F (200 °C)     | 200–500 °F<br>(100–260 °C) |
| <p><b>Gentle Bake</b> </p> <p>A combination of different heating elements ensures excellent baked good, gratins and lasagna.</p>  | 350 °F (190 °C)     | 200–475 °F<br>(100–250 °C) |

# Operating the oven

---

## Energy saving tips

- Remove any accessories from the oven that you do not require for cooking.
- Try not to open the door when cooking.
- If a temperature range is given, it is best to select the lower temperature and check the food after the shortest cooking time given.
- The factory default setting for the Time of Day display Time – Display – Off will consume the least amount of energy.
- With the factory default setting Lighting – On for 15 seconds the oven cavity lighting turns off automatically after 15 seconds. It can be turned on again at any time by selecting .
- When cooking with safety shut-off or the roast probe, the oven cavity heating will turn off automatically shortly before the end of cooking. The residual heat utilization is sufficient to finish the cooking process. The residual heat in the oven is sufficient to complete the cooking process. Energy Save Phase is shown in the display. The cooling fan and hot air fan (if turned on) will continue to run.
- To save power, the oven turns off automatically if a button is not pressed after a certain amount of time or after a cooking program has ended. The time when this happens will depend on the selected settings (function, temperature, and duration).

## Quick Guide

- Turn the oven on.

The main menu will appear.

- Place the food in the oven.
- Select Operating Modes .
- Select the desired mode.

The oven mode and recommended temperature will appear.

The oven heating, lighting, and cooling fan will turn on.

- Adjust the recommended temperature, if necessary.

Otherwise, the recommended temperature will be accepted within a few seconds. If necessary, select *Change* to go back to the temperature setting (see “Additional functions – Changing the temperature”).

- Confirm with *OK*.

The required and the actual temperatures will appear.

You will see the temperature rising in the display. When the oven temperature is reached, the buzzer will sound if it has been turned on (see “Settings – Volume – Buzzer tone”).

After the cooking program:

- Take the food out of the oven.
- Turn the oven off.

## Cooling fan

After the cooking process the cooling fan will continue to run for a while after a program is complete to prevent moisture from building up in the oven, on the control panel or surrounding cabinetry.

When the temperature in the oven has fallen sufficiently the cooling fan will turn off automatically.

The default setting can be changed if desired (see “Settings - Cooling Fan”).

## Additional functions





---

You have placed the food in the oven, selected an operating mode, and set the temperature.

By selecting Additional Settings you can adjust cooking durations and make additional settings.

- Select Change.
- Select Additional Settings.

The following menu options appear:

- Duration
- Core temperature (This option only appears when you are using the roast probe. You cannot set a cooking duration when using the roast probe.)
- Ready at
- Start at (This option only appears after Duration or Ready at has been set.)
- Rapid PreHeat (This option only appears if a temperature of more than 210°F (100°C) has been set for Convection Bake , AutoRoast , Surround , or Moisture Plus )
- Crisp function (This moisture reduction feature will allow surfaces to crisp on the outside.)
- Change type of heating (This option only appears in Moisture Plus mode . You can combine bursts of steam with other types of heat.)
- Change Operating Mode (You can change the oven mode during operation.)



### Changing the temperature

As soon as a cooking mode is selected, the corresponding recommended temperature will appear in the display together with its possible range (see “Mode overview”).

- If the recommended temperature is suitable for your recipe, confirm with *OK*.
- If it is not suitable for your recipe, you can change it for this particular cooking program.

You can also permanently reset the recommended temperature to suit your personal cooking habits (See “Settings – Recommended temperatures”).

Example: You have selected Convection Bake  and 350°F (170°C) and can see the temperature increasing.





You want to reduce the required temperature to 310°F (155°C).

- Select *Change*.
- Change the temperature.
- Confirm with *OK*.

The adjusted temperature is saved. The required and the actual temperatures will appear.

### Rapid heat-up

Rapid PreHeat can be used to speed up the preheating phase.

The Rapid PreHeat function turns on automatically if you set a temperature of more than 210°F (100°C) for Convection Bake , AutoRoast , Surround , and Moisture Plus .

Rapid PreHeat should be turned off when cooking pizza and delicate items (e.g., sponge or pastry). These will get brown too quickly on the top. Turn off the Rapid PreHeat function when preparing this kind of food.

You can turn off Rapid PreHeat for a cooking process.

# Additional functions

---

## Rapid PreHeat

– On

The browning / broiling and convection heating elements turn on together with the fan to enable the oven to reach the required temperature as quickly as possible.

– Off

Only the heater elements associated with the cooking mode are turned on.

To turn off the Rapid PreHeat function:

- Select Change.
- Select Additional Settings.
- Select Rapid PreHeat.

Off will appear in the Rapid PreHeat field.

- Confirm with OK.

Rapid PreHeat has been deactivated.

Instead of Rapid PreHeat, Preheating will appear in the display.

- Select the required oven function and the temperature.
- Rapid PreHeat should be turned off when baking pizza or delicate mixtures.
- Wait for the preheating phase to complete.

When the set temperature is reached, the buzzer will sound if it has been turned on (see “Settings – Volume – Buzzer tone”).

- Place the food in the oven.

## Using the Crisp function (moisture reduction)

It is a good idea to use this function when cooking items which are moist on the inside but which should be crispy on the outside, e.g., frozen french fries, croquettes, or breaded meats.

It is also suitable for fruit cakes, such as apple cake.

You have placed the food in the oven, selected an operating mode, and set the temperature.

The “Crisp function” can be used with any oven function. However, it has to be activated separately for each cooking process. For best results, activate it at the beginning of the cooking process.

- Select Change.
- Select Additional Settings.
- Select Crisp function.

On will appear in the Crisp function field.

- Confirm with OK.

Moisture reduction is now activated.

### Changing the operating mode

You can change the operating mode during operation.

- Select Change.
- Select Additional Settings.
- Select Change Operating Mode.
- Select the desired mode.

The new mode and the relevant recommended temperature will appear in the display.

- Change the temperature, if necessary.
- Confirm with *OK*.

The oven mode has been changed.

The times entered will be kept.

## Additional functions

---

### Setting additional durations

You have placed the food in the oven, selected an operating mode, and set the temperature.

By entering **Duration**, **Ready at** or **Start at** you can automatically turn the cooking program on or off.

– **Duration**

Enter the cooking duration you require. The oven heating turns off automatically once the cooking duration has elapsed. The maximum duration that can be set is 12:00 hours.

A cooking duration cannot be set if you are using the roast probe. When using the roast probe, the cooking duration is determined by when the set core temperature is reached.

– **Ready at**

You can set the time at which the cooking program should end. The oven will turn off automatically at the time you have set.

**Ready at** cannot be set if you are using the roast probe. When using the roast probe, the end of the cooking program is determined by when the set core temperature is reached.

– **Start at**

You specify the time you want cooking to start. The oven will turn on automatically at the time you have set.

**Start at** can only be used together with **Duration** or **Ready at**, except when using the roast probe.

### Turning off automatically

Example: It is 11:45. Your food takes 30 minutes to cook and needs to be ready at 12:15 p.m.

Select **Duration** and set 0:30 h or select **Ready at** and set the time for 12:15 p.m.

The oven will turn off automatically after this duration has elapsed or when the time set is reached.

### Setting the “Duration”

- Select **Change**.
- Select **Additional Settings**.
- Set the cooking duration.
- Confirm with **OK**.

### Setting the “Ready at” time

- Select **Change**.
- Select **Additional Settings**.
- In the **Ready at** field, set the time at which the food should be ready.
- Confirm with **OK**.

### Turning on and off automatically

We recommend having the oven turn on and turn off automatically when roasting. When baking, the oven should not be set to start a long time off. Otherwise the cake mixture or dough will dry out, and the raising agents will lose their effectiveness.

To turn a cooking program on and off automatically, you have a choice of how to enter the time parameters:

- Duration **and** Ready at
- Duration **and** Start at
- Ready at **and** Start at

Example: It is 11:30 a.m. Your food takes 30 minutes to cook and needs to be ready at 12:30 p.m.

- Select **Change**.
- Select **Additional Settings**.
- In the **Duration** field, set 0:30 h.
- In the **Ready at** field, set 12:30.
- **Confirm with OK**.

**Start at** is calculated automatically. **Start at 12:00** appears in the display.

The oven will turn on automatically at this time.

### Sequence of a cooking program that turns on and off automatically

**Up until the start time** the mode, the selected temperature, **Start at** and the start time will appear in the display.

**After the program has started** you can follow the preheating phase on the display until the required temperature is reached.

Once this temperature is reached, the buzzer will sound if it has been turned on (see “Settings – Volume – Buzzer tone”).

**After the preheating phase** the remaining duration (time left) will appear in the display.

You can follow the duration counting down on the display. The last minute counts down in seconds.

**At the end of the cooking process** the buzzer will sound if it has been turned on (see “Settings – Volume – Buzzer tones”).

The oven heating and lighting will turn off. **Program Finished** appears.

You have the option to save the program as a **Favorite** (see “Favorites”) or to increase the cooking duration using **Change**.

**During the cooling phase** the cooling fan will continue to run.

## Additional functions

---

### Changing set durations

- Select *Change*.

All options that can be changed will appear.

- Change the desired time.
- Confirm with *OK*.

These settings will be deleted in the event of a power failure.

### Canceling cooking

- Tap ↶ twice.

*Cancel Cooking?* will appear in the display.

- Select *Yes*.

The oven heating and lighting will turn off. Any cooking durations set will be deleted.

Your oven is equipped with a steam injection system for cooking with moisture. Baking, roasting and cooking with Moisture Plus  guarantees optimized steam and air conduction for excellent cooking and browning results.

After selecting Moisture Plus  you need to set the temperature and the number of bursts of steam.

The following options are available:

- Automatic burst of steam  
This requires enough water for one burst of steam. The burst of steam will be injected into the oven automatically after the preheating phase.
- 1 Burst of steam
- 2 Bursts of steam
- 3 Bursts of steam  
You need to add the appropriate amount of water for the number of bursts of steam. You have to release the bursts of steam yourself.

The steam bursts are injected into the oven cavity during the cooking program. The steam inlet is located on the ceiling of the oven interior in the rear left corner.

One burst of steam takes approx. 5–8 minutes. The number of bursts of steam and when they are injected will depend on the type of food being cooked:



- **Yeast doughs** will rise better if steam is injected at the beginning of the program.
- **Bread and rolls** will also rise better if exposed to steam at the start. Injecting a burst of steam at the end of the program will give the bread and rolls a shiny crust.
- When **roasting meat with a high fat content**, injecting steam at the beginning of roasting will help render the fat.

Moisture Plus is not suitable for mixtures which contain a lot of moisture, such as meringues, as the addition of steam does not allow them to dry out sufficiently.

## Moisture Plus

### Cooking with the Moisture Plus function

It is normal for condensation to form on the inside of the door during steam injection. This will dissipate during the course of the cooking program.

- Prepare the food and place in the oven if no preheating is required.
- Select Operating Modes .
- Select Moisture Plus .

The recommended temperature (350°F/160°C) will appear.

The oven heating, lighting, and cooling fan will turn on.

#### Setting the temperature

- Set the required temperature.
- Confirm with *OK*.

#### Setting the number of steam bursts

The oven will draw in water automatically from the water supply and then release the steam at the specified times. You will hear some pumping noises during the water intake process.

- If you would like a burst of steam to be automatically injected into the oven after the heating-up phase, select *Automatic burst of steam*.
- If you would like to inject one or more bursts of steam manually at specific times, select *1 Burst of steam*, *2 Bursts of steam* or *3 Bursts of steam*.

### Timing the bursts of steam

This option will only appear in the display after you have selected 1, 2 or 3 bursts of steam.

**Tip:** If you have selected more than one burst of steam, the second burst should be released at least 10 minutes after starting the program.

### Manual bursts of steam

- To inject the bursts of steam yourself, select *Manual*.

### Time-controlled steam

- If you want to set a time for injecting the bursts of steam, select *Time Controlled*.
- Set the desired time for each burst of steam. The oven will then release the steam at the specified times. The time begins counting down when the program is started.
- Confirm by touching *OK*.

### Changing the type of heating

All four modes (*Convection Bake*, *Surround*, *Intensive*, and *AutoRoast*) are available to use with Moisture Plus , however *Convection Bake* is set as the default mode.

- Select *Change*.
- Select *Change type of heating*.
- Select the desired mode.
- Confirm with *OK*.

The cooking program will then continue using the different type of heating selected.



## Injecting bursts of steam

 Steam can cause scalding. Do not open the door during bursts of steam. Also, condensation on the sensors will cause them to have a slow reaction time.

## Automatic burst of steam

Automatic burst of steam appears in the display.

Once the preheating phase is complete, the automatic burst of steam is injected.

The water will vaporize in the oven while steam is being released and Burst of steam active will appear in the display.

After the burst of steam Burst of steam, completed will appear in the display.

- Continue cooking until the end of the cooking duration.

## 1, 2, or 3 bursts of steam

### Manual bursts of steam

If you have selected Manual you can release the bursts of steam as soon as Start Manual burst of steam appears in the display.

Please wait until the preheating phase is completed to allow the steam to be distributed evenly by the warm air in the oven.

**Tip:** Please refer to the recipes in the recipe book for the timing of the bursts of steam. Set the timer  as a reminder.

- Select Start Manual burst of steam.

The burst of steam will be released and Burst of steam active will appear in the display.

- Proceed as described to inject further bursts of steam.

Burst of steam, completed will appear in the display after each burst of steam.

- Continue cooking until the end of the cooking duration.

## Time-controlled steam

The oven will release the steam after the specified amount of time.

## Moisture Plus

### Evaporating residual moisture

When cooking with added moisture, the water will be equally distributed between the number of steam bursts and completely used up, as long as the program is not interrupted.

However, if a program that uses added moisture is interrupted (either manually or due to a loss of power) before all the bursts of steam have been injected, the unused water will remain in the evaporation system.

The next time the Moisture Plus  mode or a MasterChef + program is used, Evaporate Residual Moisture? will appear in the display with the options Skip and Yes.

It is best to start the residual water evaporation right away so that only fresh water is steamed onto the food during the next cooking program.

### The residual moisture evaporation process

The oven will heat up and the residual water in the oven compartment will evaporate.

Depending on the amount of water, this can take up to approximately 30 minutes.

Steam can cause scalding.  
Do not open the door while the residual water is being evaporated.

During residual water evaporation, moisture will condense on the door and inside the oven compartment. Be sure to wipe away the condensation once the cavity has cooled down.

### Starting residual water evaporation immediately

Steam can cause scalding.  
Do not open the door while the residual water is being evaporated.

- Select the Moisture Plus  mode or a MasterChef + program.

Evaporate Residual Moisture? will appear in the display.

- Select Yes.

Evaporate Residual Moisture and a time then appear in the display.

The evaporation process will start. You can monitor the remaining time in the display.

The time displayed depends on the amount of water in the evaporation system. This time may be corrected

during the evaporation process to reflect the actual amount of water left in the system.

At the end of the residual water evaporation process, **Program Finished** appears in the display.

- Touch the “Back” sensor.

A cooking process using Moisture Plus  or a MasterChef + program can now be carried out.

During residual water evaporation, moisture will condense on the door and in the oven interior. Be sure to wipe away the condensation once the interior has cooled down.

## Skipping residual moisture evaporation

 Skipping the residual moisture evaporation process can cause water to overflow into the oven cavity.

Do not cancel the evaporation process.

- Select the Moisture Plus  mode or a MasterChef + program.

Evaporate Residual Moisture? appears.

- Select Skip.

You can now carry out a cooking process using the Moisture Plus  mode or a MasterChef + program.

You will be prompted to carry out the evaporation of the residual moisture process the next time you select Moisture Plus  or a MasterChef + program that uses moisture and when you turn the oven off.

# Gourmet Center

---

Your oven has a wide range of MasterChef, and MasterChef + programs that enable you to achieve excellent cooking results with ease. Simply select the appropriate program for the type of food you are cooking and follow the instructions in the display.

In the Gourmet Center you will find:

- MasterChef programs for the preparation of cakes, meats, fish dishes, desserts, etc.
- MasterChef + programs for the preparation with Moisture Plus.

## List of food types

The MasterChef programs can be found under Gourmet Center  – MasterChef.

- Baked Goods
- Fish
- Meat
- Pizza
- Potatoes
- Poultry

## MasterChef +

In MasterChef + a variety of programs are available. These MasterChef programs work with Moisture Plus.

## Using MasterChef and MasterChef + programs

From the Main Menu:

- Select Gourmet Center.
- Select MasterChef or MasterChef +.

A list of food types will appear in the display.

- Select the desired type.

The MasterChef or MasterChef + programs available for the food type selected will then appear.

- Select the desired MasterChef or MasterChef + program.

The individual steps that must be completed before starting the program appear as a list in the display.

Depending on the program selected, the following information or instruction will appear in the display:

- Type of cookware
- Shelf level
- Use of the wireless roast probe
- Cooking time
- Follow the instructions on the display

## Notes on using these programs

- After cooking, allow the oven interior to cool down to room temperature again before starting a MasterChef or MasterChef + program.
- Some programs require a preheating phase before food can be placed in the oven. A prompt will appear indicating when to add the food.
- The duration quoted for MasterChef programs is an estimate. It may increase or decrease depending on the program. When using the roast probe, the duration will be determined by when the core temperature is reached. The duration, in particular with meat, will vary depending on the initial temperature of the food.

# Gourmet Center

---

## Search

You can search the `Gourmet Center` by the name of the food type and `MasterChef` program.

This search is a full-text search and can also be used to search for parts of words.

From the Main Menu:

- Select `Gourmet Center`.

A list of food types will appear in the display.

- Select `Search`.
- Use the keyboard to enter the desired search text, e.g. “bread”.

The number of hits will be shown in the bottom right of the display.

If no match is found, or if there are more than 40 matches, the `hits` field will be deactivated and you will need to modify the search text.

- Select `hits`.

The matching food types and programs will then appear.

- Select the desired program, or select the food type and then the desired program.

The program will begin.

- Follow the instructions on the display.

## MasterChef + Recipes

On the following pages you will find some recipes for the `MasterChef +` programs.

## Baguette +

Yields: 3 Loaves

### Ingredients

26 oz. Bread Flour (approx. 5 cups plus 1 tablespoon)  
2 cups lukewarm water (16 oz)  
4 teaspoons instant yeast  
3 teaspoons salt

### Method

In a mixing bowl of a stand up mixer, whisk together the bread flour, yeast and salt. Make sure that the salt and yeast do not come into direct contact. With a paddle attachment, slowly add the water. Then switch to a dough hook and knead for 8 minutes.

Turn the dough out onto a lightly flour-dusted countertop. Shape into a ball. Cover with plastic wrap. Let rest for 30 minutes.

Knead the dough by hand for 1-3 minutes. Cover the dough and let rest 1½ hours.

Decompress the dough by gently indenting with fingers into the center of the dough. Stretch and fold the dough. Working along the length of the dough, start from the upper edge of the dough, pull forward, away from you and then bring it to the center. Pull the bottom of the dough backwards (towards yourself) and fold to the center. Do the same for the left and right side of the dough. Flip the dough over and cover with plastic wrap. Let rest 1 hour.

Divide the dough into three equal portions

Shape the dough into 6" cylinders. Working with one piece of dough at a time, (keeping the other covered in plastic wrap), shape into a rectangle. Working along the length of the dough, press with three fingers gently making several indentations into the dough. Repeat the process; roll the dough over onto itself three times until the upper edge meets the lower edge and creates a deep seam. Sealing each turn with your fingers. Pinch the seam tight and let rest for about 5 minutes (or when the dough is relaxed enough to roll) with the seam facing up. Cover with a towel.

Roll and shape the baguettes to fit the universal tray. Place on universal tray, seam side down, and let rest for about 5 minutes covered with a towel.

Score each baguette 5 times and place directly into oven. Select the MasterChef + program for Baguettes +.

Follow the directions on the display.

### Settings

Gourmet Center \ MasterChef + \ Bread + \ Baguettes +

Level: see display

Baking time: approx. 70 minutes

# Gourmet Center

---

## Banana Bread +

Yields: 1 Loaf

### Ingredients

1 cup walnuts, coarsely chopped  
1 3/4 cups bread flour  
3/4 cup granulated white sugar  
1 teaspoon baking powder  
1/4 teaspoon baking soda  
1/4 teaspoon salt  
1 teaspoon ground cinnamon  
2 large eggs, lightly beaten  
1/2 cup unsalted butter, melted and cooled  
3 ripe large bananas, mashed well  
1 teaspoon pure vanilla extract

### Method

In a large mixing bowl, whisk the walnuts, flour, sugar, baking powder, baking soda, salt, and cinnamon; set aside. Mix the butter, mashed bananas, eggs and vanilla with a wooden spoon in a medium bowl. Fold the wet banana mixture into the dry ingredients with a rubber spatula just until combined. Be careful not to over mix.

Pour batter into a prepared loaf pan that has been greased and dusted with flour.

Place loaf pan into oven and select the MasterChef + Program for Banana Bread +.

Follow the directions in the display.

### Settings

Gourmet Center \ MasterChef + \ Bread + \ Banana Bread +

Level: see display

Baking time: approx. 55 minutes



## Brioche +

Yields: 8 Brioches

### Ingredients for dough

15.2 oz. bread flour (approx.,  
2 3/4 cups plus 3 tablespoons)  
1 1/2 teaspoon osmotolerant yeast  
2 tablespoons plus 1 1/4 teaspoon sugar  
3/4 teaspoon salt  
1/4 cup water  
4 large eggs  
19 tablespoons butter

### Ingredients for egg wash

1 egg whisked  
Pinch of salt  
1/2 teaspoon milk

### Method

Cut butter into 1/2 inch pieces and place on a plate. Let butter sit at room temperature until softened. In the bowl of a stand mixer, add flour, yeast, sugar and salt. Whisk to combine. Make sure yeast and salt do not come into direct contact.

With the paddle attachment, add the water and eggs until well combined. Switch to a dough hook and knead for about 10 minutes.

When dough is soft and elastic, gradually add the softened butter one piece at a time until well incorporated. (If butter is not thoroughly incorporated, it will be difficult to roll out the dough.)

Transfer dough to a large greased bowl and cover with plastic wrap. Place the bowl into refrigerator for about 15 hours.

Remove the dough from the refrigerator and turn out onto a flour-dusted countertop. Divide the dough into 4 equal squares. Roll the dough into cylinders. Visually mark the dough cylinder into thirds. Place the edge of your hand on the top third and make a sawing/rolling motion.

With the flat part of your hand, pat down the thicker sides to 1 1/2 inch thickness. Take your thumb and poke a hole about a 1/2 inch from the bottom.

Take the top third and loop it through the bottom hole.

Shape the brioche. Set each piece into a greased mold with the larger (base) part on the bottom.

Repeat steps for the 8 brioches.

Place brioches on the perforated baking tray. Brush with egg wash.

Place in oven and select MasterChef + Program for Brioche +.

Follow the directions in the display.

### Settings

Gourmet Center \ MasterChef + \ Bread + \ Brioche +

Level: see display

Baking time: approx. 43 minutes

# Gourmet Center

---

## Ciabatta +

Yields: 2 Loaves

### Ingredients for Sponge

16 oz. 00 flour or Italian-style flour  
(approx. 3 ¼ cups)

.3 oz. instant yeast (2 teaspoons)

17 oz. water, lukewarm (2 ¼ cups)

.8 oz. olive oil (2 tablespoons)

### Ingredients for Final Dough

.5 oz. salt (1 ¾ teaspoons)

9 oz. 00 flour or Italian-style flour

(approx. 1 cup plus 3 tablespoons)

### Method

In the bowl of a stand mixer, add in the flour and the yeast and whisk together.

With a paddle attachment, add the wet ingredients until a soft, smooth sponge is formed. Loosely cover with plastic wrap and let proof for 1 hour in the mixing bowl.

After proofing slowly, add the ingredients for the final dough with the paddle attachment. Mix the dough for about 2 minutes maximum. The dough should feel sticky to the touch.

Grease a baking sheet with olive oil. Transfer the dough to the baking pan and cover with lightly oiled plastic wrap. Shape the dough into a rectangle and let rise at room temperature for 20 minutes.

Stretch and fold the dough. Fold the short end of the rectangle over each other (away from you) then fold it to the center.

Then fold the bottom of the dough down (towards you) and fold to the center. Do the same for the left and right side of the dough. Turn the dough over seam side down gently and cover with plastic wrap. Let the dough rest for 20 minutes and repeat the procedure three more times.

During the last 20 minute rest select the MasterChef + program for Ciabatta +. Follow the directions in the display. (Oven will Preheat). Once the last twenty-minutes has past, transfer the Ciabatta to a flour-dusted universal tray. Dust the top of the dough with flour. Using a dough cutter, cut the dough lengthwise to create two long loaves. Shape the loaves evenly. Using your first three fingers gently make about five rows of indentations in the dough about ¼" deep.

Once the oven has preheated place the Ciabatta in the oven.

### Settings

Gourmet Center \ MasterChef + \ Bread + \ Ciabatta +

Level: see display

Baking time: approx. 45 minutes

## Cinnamon Raisin Bread +

Yields: 1 Loaf

### Ingredients for dough

3 ½ cups (18.6 oz.) Bread Flour  
3 T + 2 t (2 oz.) Granulated Sugar  
1 t (0.3 oz.) Salt  
1 ¼ t (0.2 oz.) Osmotolerant Yeast  
2 T + ½ t (1 oz) Vegetable Oil  
2 Large Eggs  
2 Large Egg Yolks, reserve whites and whisk until frothy  
¾ to 1 cup Water  
¼ t (0.2 oz) Cinnamon  
1 cup (6 oz) Baking Raisins

### Ingredients for cinnamon sugar (for dusting)

¼ cup Sugar  
1 T Cinnamon

### Method

Mix wet and dry ingredients separately (excluding the raisins and the cinnamon sugar).

While using a stand-up mixer with a paddle attachment, slowly add the wet to the dry and mix until incorporated.

Switch to a dough hook and knead at low speed for about 6 minutes. In the last two minutes add raisins.

When raisins are thoroughly incorporated into the dough, remove and shape into ball. Place the dough ball into greased bowl. Cover with plastic wrap and let rise for 1 hour.

Next, on a lightly floured surface, knead dough for 2 minutes. Place back into the greased bowl and proof for 1 hour.

Roll dough into a rectangle about ½ inch thick, sprinkle heavily with cinnamon sugar. Roll like a jelly roll to fit the length of a loaf pan. Pinch off any seams. Place into a well-greased loaf pan.

Egg wash the loaf with reserved egg whites and cover with plastic wrap and proof for 60 minutes.

Egg wash again and dust with cinnamon sugar to taste.

Place in oven and select MasterChef + Program for Cinnamon Raisin Bread +.

Follow the directions in the display.

### Settings

Gourmet Center \ MasterChef + \ Bread + \ Cinnamon Raisin Bread +

Level: see display

Baking time: approx. 66 minutes

# Gourmet Center

---

## French Bread +

Yields: 2 Loaves

### Ingredients

26 oz. French Style Flour (approx.  
5 cups plus 1 tablespoon)  
2 cups lukewarm water (16 oz)  
4 teaspoons instant yeast  
3 teaspoons salt

### Method

In a mixing bowl of a stand mixer, whisk together the French flour, yeast and salt. Make sure that the salt and yeast do not come into direct contact. With a paddle attachment, slowly pour in water. Then switch to a dough hook and knead for 8 minutes.

Transfer dough to a lightly flour-dusted work surface. Shape the dough into a ball. Cover with plastic wrap. Let rest for 30 minutes.

Knead dough for 5 minutes by hand. Cover the dough and let rest 1½ hours.

Stretch and fold the dough. Start from the top of the dough pull forwards (away from you) then bring it to the middle. Then pull bottom of the dough backwards (towards yourself) and fold to the middle. Do the same for the left and right side of the dough. Flip the dough over and cover with plastic wrap. Let rest 1 hour.

Divide the dough in half and shape into loaves that are about 10" long and 2" wide and tapered at the ends.

Place on perforated baking tray. Cover with a towel and rest for 20 minutes.

Score the loaves three times and place directly into the oven and select the MasterChef + program for French Bread +.

Follow the directions on the display.

### Settings

Gourmet Center \ MasterChef + \ Bread + \ French Bread +

Level: see display

Baking time: approx. 70 minutes

## Italian Bread +

Yields: 2 Loaves

### Ingredients

25.4 oz. bread flour (approx. 4 3/4 cups plus 3 tablespoons)  
6 oz. extra fancy (fine grain) semolina flour (approx. 1 cup)  
1 tablespoon sugar  
1 tablespoon instant yeast  
1 tablespoon salt  
1 pound lukewarm water (approx. 2 cups)  
¼ cup extra virgin olive oil  
Untoasted sesame seeds

### Method

Mix the bread flour, semolina flour, sugar, yeast and salt together in the bowl of a stand mixer. Make sure yeast and salt do not come into direct contact. With a paddle attachment, slowly add the wet ingredients until combined.

Switch to a dough hook and knead for about 10 minutes.

Turn dough out onto a lightly floured work surface. Shape the dough into a ball, cover with plastic wrap and proof for 1½ hours

Divide the dough into equal two pieces.

Shape into two loafs that are about a 14" long by 2" wide and taper at both ends. Place dough on perforated baking tray and cover with plastic wrap. Proof for another 20 minutes.

Score dough 3 times, lightly brush with water and sprinkle with sesame seeds immediately.

Place in oven and select the MasterChef + program for Italian Bread +.

Follow the directions on the display.

### Settings

Gourmet Center \ MasterChef + \ Bread + \ Italian Bread +

Level: see display

Baking time: approx. 48 minutes

# Gourmet Center

---

## Jalapeño Cheese Bread +

Yields: 2 Loaves

### Ingredients

2 cups hot water  
.2 ounces instant yeast  
2 teaspoons sugar  
2 tablespoons olive oil  
5 cups unbleached all-purpose flour  
9 ounces cheddar cheese, grated  
4 ounces fresh jalapeños, finely chopped  
2 tablespoons salt  
3 tablespoons garlic powder (or to taste)  
Extra grated cheddar cheese, to cover loaves

### Method

In a measuring cup add the water, yeast and 1 teaspoon of sugar. Mix together until incorporated. Let rest for 10 minutes or until foamy.

Add the olive oil to the water and yeast mixture.

In the bowl of a stand mixer, add all of the dry ingredients except for the garlic powder. Make sure the cheddar and jalapeños are coated with flour.

With a dough hook attachment, slowly add the wet ingredients to the dry.

Mix about 5 minutes or until well incorporated. During the last minute add in the garlic powder.

Transfer the dough into a well-greased large bowl and cover. Proof for about 1 hour.

Then shape into loaves, place into a well-greased tea loaf pan and cover. Proof for another 1 hour.

Grate extra cheddar to cover the top of the loaves as desired.

Place the loaves in the oven and select the MasterChef + program for Jalapeno Cheese Bread +.

Follow the directions on the display.

### Settings

Gourmet Center \ MasterChef + \ Bread + \ Jalapeno Cheese Bread +

Level: see display

Baking time: approx. 55 minutes

## Multigrain Bread +

Yields: 2 Loaves

### Ingredients

15 oz. nine grain flour blend (approx. 3 cups plus 2 tablespoons)  
16.5 oz. bread flour (approx. 3 cups plus 3 tablespoons)  
1 1/3 cups harvest grains mix  
3 teaspoons salt  
4 teaspoons instant yeast  
1 tablespoon light brown sugar  
1 tablespoon honey  
4 tablespoons vegetable oil  
3 cups water

### Method

In the bowl of a stand mixer, add the dry ingredients and whisk together. Make sure the yeast does not come into contact with salt.

In a small bowl, combine honey, vegetable and water. With the paddle attachment, slowly incorporate the wet ingredients into the dry.

Switch to a dough hook and knead for about 8 minutes.

Turn the dough out onto a work surface and shape the dough into a ball.

Place the dough into an oiled bowl, cover with plastic wrap and proof for 1 hour.

Divide dough and shape into two round loaves and place on perforated baking tray.

Place into oven immediately and select the MasterChef + program for Multigrain Bread +.

Follow the directions on the display.

### Settings

Gourmet Center \ MasterChef + \ Bread + \ Multigrain Bread +

Level: see display

Baking time: approx. 60 minutes

# Gourmet Center

---

## Rolls +

Yields: 8 Rolls

### Ingredients

21.2 oz. unbleached bread flour  
(approx. 4 cups plus 1 tablespoon)  
2 teaspoons instant yeast  
2 ½ teaspoons salt  
8 ounces sourdough starter (approx.  
1 cup)  
13.4 oz. water (approx. 1 ¾ cups)

### Method

In the bowl of a stand mixer, combine flour, yeast and salt. Mix together with a whisk. With the paddle attachment mix in sourdough starter until coated with the dry ingredients. Slowly incorporate water, mix until combined. Switch to the dough hook and knead for 15 minutes.

Dust countertop lightly with flour. Transfer dough to countertop and knead by hand for 5 minutes. The dough will be slightly sticky. Dust dough very lightly with flour as needed.

Shape the dough into a ball and cover with plastic wrap, let rest for 2 hours on countertop

Divide dough into 8 equal portions and shape into rolls. Cover with plastic wrap and let rest for 30 minutes.

Place dough on the perforated baking tray.

Score dough and make one quick slice down the center of the roll.

Immediately place rolls in oven and select MasterChef + program for Rolls +.

Follow the directions on the display

### Settings

Gourmet Center \ MasterChef + \ Bread + \ Rolls +

Level: see display

Baking time: approx. 54 minutes



## Rye Bread +

Yields: 2 Loaves

### Ingredients for Preferment

5.6 oz. bread flour (approx. 1 cup plus 2 tablespoons)  
.02 oz. instant yeast (approx. 1/8 teaspoon)  
.2 oz. salt (approx. 3/4 teaspoon)  
5.4 oz. water (approx. 3/4 cup)

### Ingredients for Final Dough

14 ounces bread flour (approx. 2 3/4 cup)  
11 oz. medium rye flour (approx. 2 1/2 cups plus 1 tablespoon)  
.2 oz. instant yeast (approx. 1 1/2 teaspoons)  
.375 oz. salt (approx. 1 1/2 teaspoons)  
14 oz. water (approx. 3/4 cup)  
2 oz. caraway seeds (1 1/2 teaspoons)

### Method

In the bowl of a stand mixer, combine flour, yeast and salt for the preferment. Then add 5.4 ounces of lukewarm water. Mix until thoroughly incorporated. Cover with plastic wrap and let rise for 1 hour or up to 15 hours at room temperature.

In the bowl of a stand mixer, combine all of the dry ingredients for the final dough together except for the caraway seeds. Add dry ingredients to preferment. With the paddle attachment, slowly drizzle in the 14 ounces of lukewarm water. Switch to a dough hook. Knead for about 6 minutes. Add the caraway seeds during the last two minutes of mixing.

Remove dough from the bowl and shape into a ball. Cover the dough and proof for 1 1/2 hours.

Divide dough in half. Shape into two loaves. Start by patting the dough into a rectangle about the length of the tea loaf pan (12") and about 6" wide. Fold the dough into thirds; repeat this two more times until you have a log. Pinch the ends and the long seam to seal.

Place into ceramic tea loaf pans. Cover and let rest for 35 minutes.

Place into oven and select the MasterChef + program for Rye Bread +.

Follow the directions on the display.

### Settings

Gourmet Center \ MasterChef + \ Bread + \ Rye Bread +

Level: see display

Baking time: approx. 70 minutes

# Gourmet Center

---

## San Francisco Sourdough +

Yields: 2 Loaves

### Ingredients

27.5 oz. bread flour (approx. 5 ¼ cups plus 2 tablespoons)  
.03 oz. instant (approx. 2 ½ teaspoons)  
.7 oz. salt (approx. 2 ½ teaspoons)  
10.5 sour dough starter (approx. 1 ¼ cups)  
2 cups water (1 pound)

### Method

Add bread flour, yeast and salt in the bowl of a stand mixer. Mix together with a whisk. Add the sourdough starter, mix until coated with the dry ingredients. Slowly incorporate water. Mix until combined. Switch to a dough hook and knead for 15 minutes.

Dust a work surface lightly with flour. Turn the dough onto the work surface and knead by hand for 3-5 minutes. The dough will be slightly sticky. Dust the dough very lightly with flour as needed.

Shape into a ball and cover with plastic wrap, proof for 2 hours on countertop

Divide dough into 2 equal portions and shape into a boule (round loaf). Place loaves on perforated baking tray. Cover loosely with plastic wrap and let rest for 20 minutes.

Score the dough with 4 strokes to form a square design with a lame (double edge blade) or a very sharp paring knife.

Immediately place in oven and select the MasterChef + Program for San Francisco Sourdough +.

Follow the directions in the display.

### Settings

Gourmet Center \ MasterChef + \ Bread + \ San Francisco Sourdough +

Level: see display

Baking time: approx. 54 minutes

## Walnut Bread +

Yields: 2 Loaves

### Ingredients

26 oz. French Style Flour (approx.  
5 cups plus 1 tablespoon)  
2 cups lukewarm water (16 oz)  
4 teaspoons instant yeast  
3 teaspoons salt  
2/3 cups walnuts  
2/3 cup dried cherries

### Method

In a mixing bowl of a stand mixer, whisk together the French flour, yeast and salt. Make sure that the salt and yeast do not come into direct contact. With a paddle attachment, slowly pour in water. Then switch to a dough hook and knead for 8 minutes. During the last two minutes add in the cherries and the walnuts.

Transfer dough to a lightly flour-dusted work surface. Shape the dough into a ball. Cover with plastic wrap. Let rest for 30 minutes.

Knead dough for 5 minutes by hand. Cover the dough and let rest 1½ hours.

Stretch and fold the dough. Start from the top of the dough pull forwards (away from you) then bring it to the middle. Then pull bottom of the dough backwards (towards yourself) and fold to the middle. Do the same for the left and right side of the dough. Flip the dough over and cover with plastic wrap. Let rest 1 hour.

Divide the dough in half and shape into round loaves.

Place on perforated baking tray. Cover with a towel and rest for 20 minutes.

Score the loaves three times and place directly into the oven and select the MasterChef + program for Walnut Bread +.

Follow the directions on the display.

### Settings

Gourmet Center \ MasterChef + \ Bread + \ Walnut Bread +

Level: see display

Baking time: approx. 70 minutes

# Gourmet Center

---

## White Bread +

Yields: 2 Loaves

### Ingredients

26 oz. Bread Flour (approx. 5 cups plus 1 tablespoon)  
2 cups lukewarm water (16 oz)  
4 teaspoons instant yeast  
3 teaspoons salt

### Method

In a mixing bowl of a stand mixer, whisk together the French flour, yeast and salt. Make sure that the salt and yeast do not come into direct contact. With a paddle attachment, slowly pour in water. Then switch to a dough hook and knead for 8 minutes.

Transfer dough to a lightly flour-dusted work surface. Shape the dough into a ball. Cover with plastic wrap. Let rest for 30 minutes.

Knead dough for 5 minutes by hand. Cover the dough and let rest 1½ hours.

Stretch and fold the dough. Start from the top of the dough pull forwards (away from you) then bring it to the middle. Then pull bottom of the dough backwards (towards yourself) and fold to the middle. Do the same for the left and right side of the dough. Flip the dough over and cover with plastic wrap. Let rest 1 hour.

Divide the dough in half and shape into loaves that are about 10" long and 2" wide and tapered at the ends.

Place on perforated baking tray. Cover with a towel and rest for 20 minutes.

Score the loaves three times and place directly into the oven and select the MasterChef + program for White Bread +.

Follow the directions on the display.

### Settings

Gourmet Center \ MasterChef + \ Bread + \ White Bread +

Level: see display

Baking time: approx. 70 minutes

## Whole Grain Bread +

Yields: 2 Loaves

### Ingredients

29.3 oz. bread flour (approx. 5 cups plus 2 tablespoons)  
14.6 oz. whole wheat flour (approx. 3 cups plus 2 tablespoons)  
1 tablespoon salt  
1 tablespoon instant yeast  
4 oz. sour dough starter (approx. ½ cup)  
1 1/3 cup whole grains (your favorite blend)  
29.2 oz. water (approx. 3 3/4 cups)

### Method

In the bowl of a stand mixer combine all the ingredients except for the water with the paddle attachment. Slowly drizzle in water until combined. Switch to the dough hook attachment and knead for about 4 minutes.

Turn the dough out to a lightly dusted work surface. Shape the dough into a ball. Cover with plastic wrap. Let rest for 30 minutes.

Knead the dough by hand for one minute. Cover the dough and let rest 1 ½ hours.

Stretch and fold the dough; start from the top of the dough, stretch up (away from you) then bring it to the center. Then stretch the bottom of the dough up (towards you) and fold in the middle. Do the same for the left and right sides of the dough. Turn the dough over, seam side down and cover with plastic wrap. Let rest 1 hour.

Divide the dough into 2 portions. Shape each portion into a rectangle; start by taking one of the dough portions and shape into a rectangle, roughly the dimension of a loaf pan. With your first three fingers gently make several indentations into the dough. Next, roll the dough over three times. Sealing each turn with your hand. Pinch the seam tightly and place seam side down into well-greased loaf pans.

Cover and let rest for 35-40 minutes.

Place into oven and select the MasterChef + program for Whole Grain Bread +.

Follow the directions on the display.

### Settings

Gourmet Center \ MasterChef + \ Bread + \ Whole Grain Bread +

Level: see display

Baking time: approx. 60 minutes

# Gourmet Center

---

## Mini Cheesecake +

Serves 10

### Filling

18 oz cream cheese, softened  
3/4 c sugar  
2 tbsp unsalted butter, softened  
1 tbsp lemon juice  
1 tsp pure vanilla extract  
3 large eggs  
4 tbsp heavy cream  
3 tbsp sour cream

### Graham Cracker Crust

3/4 c crushed graham crackers  
2 tbsp sugar  
4 tbsp butter  
1 stick butter for greasing ramekins

### Method

In a stand up mixer, use the paddle to slowly mix the cream cheese until smooth.

Add in the softened butter and sugar, mix until smooth.

Continue mixing with the paddle and add in one egg at a time until smooth. Scrape down the bowl as needed.

Switch to a whisk attachment and slowly add in the heavy cream and sour cream. Mix until completely smooth.

Grease ramekins with butter.

Place the graham cracker crust mixture into the bottom of ten 7 oz oven-safe ramekins. With your fingertips push down until a crust is formed.

Ladle about 4 oz into each ramekin.

Place the ramekins onto the Miele Baking Tray.

Select the MasterChef + program for Mini Cheesecake +.

Follow the directions in the display.

### Recommended settings

Gourmet Center \ MasterChef + \ Dessert +  
\ Mini Cheesecake +

Baking time:  
approximately 45 min

## Mini Chocolate Cakes +

Serves 10

### Ingredients

1/3 c + 1 tbsp Dutch process cocoa powder  
1 ¼ c all-purpose flour  
1 c + 2 tbsp + 1 tsp sugar  
½ tsp baking soda  
1 tsp baking powder  
½ tsp salt  
1/3 c + 1 tbsp vegetable oil  
¼ c sour cream  
2 large eggs  
1 tsp vanilla  
¾ c water  
2½ oz. 64% semisweet chocolate, melted and cooled slightly

### Method

Bring ¾ c water to a boil. Whisk in cocoa powder and let cool.

Sift together the flour, sugar, baking powder, baking soda and salt.

Whisk together eggs, sour cream, vegetable oil, vanilla extract, melted chocolate and the cooled cocoa water mixture.

Slowly drizzle the wet ingredients into the dry. Whisk together and place into ten 7 oz ramekins and place on a Miele Baking Tray.

Select the MasterChef + program for Small Chocolate Cakes +.

Follow the directions in the display.

### Recommended settings

Gourmet Center \ MasterChef + \ Dessert + \ Small Chocolate Cakes +

Baking time:  
approximately 43 min

### Tip

Serve with whipped cream and fresh berries.

## Turnovers +

Serves 12

### Apple Filling

1 sheet puff pastry  
1 large granny smith apple, peeled and  
¼ inch dice  
1/8 tsp cinnamon  
2 tbsp light brown sugar  
½ tsp lemon juice  
¼ c water  
½ tsp corn starch  
1 tbsp cold water

### Crème Anglaise

1 c milk  
1 c heavy cream  
1 bourbon vanilla bean, scraped (use all  
of it)  
4 egg yolks, whites whisked and  
reserved for puff pastry  
¼ c sugar

### Apple Filling

Peel the granny smith apple. Dice into  
¼ inch cubes. Toss with lemon juice.  
Add the apples, ¼ c cold water,  
cinnamon, and brown sugar to a sauce  
pan. Bring to a simmer.

In a small bowl mix ½ tsp of cornstarch  
with 1 tbsp of water. Mix this together  
until a milky liquid is formed. Pour  
immediately into apple mixture as you  
whisk vigorously for at least  
15 seconds. Reduce heat slightly and  
simmer until apples are al dente but not  
over cooked, about 5 minutes.

### Crème Anglaise

Bring 1 pot of water, (about half way  
filled) to a simmer. In another sauce  
pan, warm up heavy cream and milk.  
Whisk in vanilla bean and the  
scrapings. Do not bring to a simmer,  
heat up to about 100 °F.

In a room temperature heat proof  
mixing bowl combine sugar and egg  
yolk until sugar is dissolved. Slowly  
drizzle in milk/cream mixture into egg  
yolks. Whisk vigorously so you do not  
scramble the egg yolks.

Place metal bowl over the pot of  
simmering water. Whisk the sauce  
rapidly and rotate bowl until the sauce  
reaches a temperatures 176 °F do not  
cook over 180 °F. Strain the sauce into  
a bowl and immediately place into an  
ice bath to stop the cooking process.  
Reserve sauce in refrigerator and serve  
sauce cold with turn over.

### Filling Turnovers

When the apple filling is cooled, place a  
semi-frozen sheet of puff pastry on a  
parchment lined cutting board. Cut out  
twelve 3 x 3 inch in squares and place  
on a lined parchment lined sheet pan.  
Brush the inside of the puff pastry with  
egg whites. Place no more than a  
quarter sized amount of apple in the  
center of each pastry. Turn fold the  
pastry in half and seal tightly with the  
tines of a fork.



Select the MasterChef + program for Turnovers +.

Follow the directions in the display.

**Recommended settings**

Gourmet Center \ MasterChef + \ Dessert +  
\ Turnovers +

**Baking time:**  
approximately 48 min

# Gourmet Center

---

## Branzino +

Serves 4

### Ingredients

Four 1 lb pieces of branzino (scaled, gutted, head on)  
Extra virgin olive oil  
1 lemon, sliced paper thin half circles  
Parsley leaves  
Sea Salt  
Freshly cracked black pepper

### Method

To prepare the branzino for stuffing:  
Take the tip of a pairing knife, cut along the inside of the fish and down the spine and ribs, on both sides of the fish. This will create a pocket. Do not puncture through the skin of the fish.

Brush each fish lightly with olive oil and season with salt. Season the pocket of the fish with sea salt and freshly cracked black pepper. Slide in a few slices of lemon and some parsley leaves.

Select the MasterChef + program for Branzino +.

Follow the directions in the display.

When the oven alerts you that it is preheated. Preheat a cast iron pan on high heat with enough olive oil to coat the bottom.

Place all the branzino into the hot pan. You should hear a sizzle.

Place the pan immediately into the preheated oven.

### Recommended settings

Gourmet Center \ MasterChef + \ Fish + \ Branzino +

Cooking time:  
approximately 32 min

### Tip

If you are using a gas or electric cooktop, the Miele Gourmet Casserole Dish is a perfect accessory for preparing this dish.

## Cod Fillet +

Serves 4

### Ingredients

Two 8 oz cod fillets  
1 stick unsalted butter  
1 tbsp garlic, finely chopped  
2 tbsp shallots, finely chopped  
3 tbsp parsley, finely chopped  
2 large lemons, ¼ inch sliced  
¾ c toasted unseasoned bread  
crumbs  
Sea salt, to taste

### Method

Melt butter in a sauce pan on low heat, add garlic and cook until aromatic.

Add in shallots and sweat until translucent. Stir in bread crumb and allow to cool.

Once bread crumbs are cool, add in parsley and season with salt.

Pat the cod fillets dry. Lay sliced lemon down on Miele Universal Tray, place fillets on top of lemon.

Sprinkle bread crumb topping on the fillets.

Select the MasterChef + program for Cod Fillet +.

Follow the directions in the display.

### Recommended settings

Gourmet Center \ MasterChef + \ Fish + \ Cod Fillet +

Cooking time:  
approximately 38 min

# Gourmet Center

---

## Halibut +

Serves 4

### Ingredients

Four 8 oz halibut fillets, skin on  
6 tbsp butter, cut into 6 pads  
2 tsp shallots, finely chopped  
¼ c slivered and blanched almonds  
1 tbsp extra virgin olive oil  
Sea salt, to taste  
Freshly cracked black pepper, to taste  
½ c dry white wine  
¼ tsp fresh squeezed lemon juice  
3 lemons, sliced

### Method

Pat dry the halibut fillets. Lay down lemon slices on the roasting and grilling insert and place on the Miele Universal Tray.

Place the halibut fillets on the lemon slices. Brush with olive oil and season with sea salt.

Select the MasterChef + program for Halibut +.

Follow the directions in the display.

While the fish is cooking place the almonds in a non-stick sauté pan and toast on medium heat.

Make the sauce by adding the white wine, shallots and one twist cracked black pepper. Bring to a simmer and reduce into a syrup.

When the white wine is reduced, turn the heat to the lowest setting. Slowly whisk in butter one pad at a time until all is incorporated.

Whisk in the lemon juice and keep the sauce warm.

Serve each halibut fillet with a topping of toasted almonds and a drizzle of sauce.

### Recommended settings

Gourmet Center \ MasterChef + \ Fish + \ Halibut +

Cooking time:  
approximately 30 min

## Red Snapper +

Serves 4

### Ingredients

2 ½ lb red snapper (scaled, gutted, head on)  
Extra virgin olive oil  
1 lemon, sliced paper thin, half circles  
Your favorite herbs  
Sea salt  
Freshly cracked black pepper

### Method

To prepare the red snapper for stuffing: Take the tip of a pairing knife, cut along the inside of the rib bones and down the spine, on both sides of the fish. This will create a pocket. Do not puncture through the skin of the fish.

Brush the red snapper lightly with olive oil and season with salt. Season the pocket of the fish with sea salt and freshly cracked black pepper. Slide in a few slices of lemon and your favorite herbs.

Select the MasterChef + program for Red Snapper +.

Follow the directions in the display.

Once the oven is preheated, coat the bottom of a cast iron pan with olive oil and warm using high heat.

Place the red snapper into the hot pan. You should hear a sizzle.

Place the pan immediately into the preheated oven.

### Recommended settings

Gourmet Center \ MasterChef + \ Fish + \ Red Snapper +

**Cooking time:**  
approximately 50 min

### Tip

If you are using a gas or electric cooktop, the Miele Gourmet Casserole Dish is a perfect accessory for preparing this dish.

# Gourmet Center

---

## Sea Bass +

Serves 4

### Ingredients

Four 1¼ lb pieces of black sea bass (scaled, gutted, head on)  
Extra virgin olive oil  
1 lemon, sliced paper thin, half circles  
Your favorite herbs  
Sea salt  
Freshly cracked black pepper

### Method

To prepare the sea bass for stuffing:  
Take the tip of a pairing knife, cut along the inside of the fish and down the spine, on both sides of the fish. This will create a pocket. Do not puncture through the skin of the fish.

Brush the sea bass lightly with olive oil and season with salt. Season the pocket of the fish with sea salt and freshly cracked black pepper. Slide in a few slices of lemon and your favorite herbs.

Select the MasterChef + program for Sea Bass +.

Follow the directions in the display.

When the oven alerts you that it is preheated. Preheat a cast iron pan on high heat with enough olive oil to coat the bottom.

Place sea bass into the hot pan. You should hear a sizzle.

Place the pan immediately into the preheated oven.

### Recommended settings

Gourmet Center \ MasterChef + \ Fish + \ Sea Bass +

**Cooking time:**  
approximately 42 min

### Tip

If you are using a gas or electric cooktop, the Miele Gourmet Casserole Dish is a perfect accessory for preparing this dish.

## Trout +

Serves 4

### Ingredients

4 farm raised trout (scaled, gutted and butterflied)

16-20 slices of bacon

Sea salt

### Method

Open up the butterflied trout and season the inside with a pinch of salt. Fold the fish back over.

Wrap each fish with 4-5 bacon slices so that the skin is completely covered. Trimming may be required depending on the length of the bacon used.

Place all four fish on the roasting and grilling insert and place into the Miele Universal Tray.

Select the MasterChef + program for Trout +.

Follow the directions in the display.

### Recommended settings

Gourmet Center \ MasterChef + \ Fish + \ Trout +

Cooking time:  
approximately 40 min

# Gourmet Center

---

## Whole Salmon Fillet +

Serves 4-6

### Ingredients

2 ½ lb salmon fillet, skin-on

### Marinade/Sauce

½ c soy sauce

1/8 tsp sesame oil

½ tsp ground ginger

2 tbsp sweet chili sauce

Sriracha, to taste

1 tbsp light brown sugar

1 tsp aji-mirin

3-4 lemons sliced ¼ inch

### Method

Lay the lemon slices on the roasting and grilling insert on the Miele Universal Tray to mirror the shape of the fillet.

Lay the salmon skin side down on top of the lemons.

Whisk together all the ingredients for the marinade/sauce.

Reserve 1/8 c of marinade/sauce.

Brush the fillet with the marinade.

Marinate for 15 minutes.

Select the MasterChef + program for Salmon Fillet +.

Follow the directions in the display.

Place the remaining marinade in a sauce pan and bring to a boil. Serve the sauce hot with the whole salmon fillet.

### Recommended settings

Gourmet Center \ MasterChef + \ Fish + \ Salmon Fillet +

Cooking time:

approximately 55 min



## Beef Tenderloin +

Serves 6

### Ingredients

3 lbs beef tenderloin  
2 thyme sprigs, chopped  
Sea salt  
Freshly cracked black pepper  
Olive oil

### Method

Rub beef tenderloin roast with olive oil, salt and pepper.

In a non-stick sauté pan add in olive oil and bring to medium-high heat. Sear meat on all sides.

Insert the roast probe into center of the meat and place onto Miele Universal Tray with the grilling and roasting insert.

Select the MasterChef + program for Beef Tenderloin +.

Follow the directions in the display.

### Recommended settings

Gourmet Center \ MasterChef + \ Meat + \ Beef Tenderloin +

Cooking time:  
approximately 2 h 35 min - 3 h 25 min

### Tip

Cut beef tenderloin in half if pan is too small to sear the whole tenderloin. Use the griddle to sear the whole tenderloin if your appliance is equipped with one.

# Gourmet Center

---

## Bison Rib Roast +

Serves 6-8

### Ingredients

4 lbs bison rib roast, roast ready  
Sea salt  
Freshly cracked black pepper  
Olive oil

### Method

Rub rib roast with olive oil, salt and pepper.

Insert the roast probe into center of the meat and place on top of the roasting and grilling insert. Place into the Miele Universal Tray.

Select the MasterChef + program for Bison Rib Roast +.

Follow the directions in the display.

### Recommended settings

Gourmet Center \ MasterChef + \ Meat + \  
Bison Rib Roast +

Cooking time:

approximately 2 h 5 min - 4 h 5 min

### Tip

Beef rib roast can be substituted if bison is unavailable.

## Bison Short Ribs +

Serves 6

### Ingredients

12 bison short ribs, bone-in  
Fresh thyme, 4 sprigs  
2 large onions, julienne  
2 medium carrots, peeled, sliced  
3 quarts bison or beef stock  
2 celery stalks, sliced  
3 garlic cloves  
¼ c dry red wine  
Sea salt  
Freshly cracked black pepper  
1 tbsp olive oil

### Method

In a sauté pan add in olive oil and bring to medium heat. Add in onions and sweat for about 5 minutes. Add in carrots, celery and garlic and continue cooking for 3 minutes. Add in ¼ c red wine and reduce by half.

Place vegetables into the Miele Gourmet Casserole Dish and spread evenly on the bottom of the pan. Allow vegetables to cool.

Season the short ribs with salt and freshly cracked black pepper. Place short ribs bone side down on the vegetables. Distribute the thyme evenly in the pan.

Pour in the stock so the top of the short ribs are just covered with beef stock.

Select the MasterChef + program for Bison Short Ribs +.

Follow the directions in the display.

### Recommended settings

Gourmet Center \ MasterChef + \ Meat + \ Bison Short Ribs +

**Cooking time:**

approximately 4 h 5 min

### Tip

Strain cooking liquid and skim fat off of top and serve as au jus. Sauce can be reduced then thickened with a roux or cornstarch slurry. Beef short ribs can be substituted if bison is unavailable.

# Gourmet Center

---

## Lamb Crown Roast +

Serves 6-8

### Ingredients

3 lbs lamb crown roast  
Rosemary, chopped  
Sea salt  
Freshly cracked black pepper  
Olive oil

### Method

Rub crown roast with olive oil, chopped rosemary, salt and pepper.

Preaheat a non-stick pan on cooktop, sear bottom of crown roast.

Place the crown roast on the Miele Universal tray with the roast and grilling insert in place.

Select the MasterChef + program for Lamb Crown Roast +.

Follow the directions in the display.

### Recommended settings

Gourmet Center \ MasterChef + \ Meat + \ Lamb Crown Roast +

Cooking time:  
approximately 3 h

## Lamb Shanks +

Serves 8

### Ingredients

8 lamb shanks, bone-in  
Thyme, 4 sprigs  
Fresh rosemary  
2 large onions, julienne  
2 medium carrots, peeled, sliced  
3 qts lamb or beef stock  
2 celery stalks, sliced  
3 garlic cloves  
¼ c dry red wine  
Sea salt  
Freshly cracked black pepper  
1 tbsp olive oil

### Method

In a sauté pan add in olive oil and bring to medium heat. Add in onions and sweat for about 5 minutes. Add in carrots, celery and garlic and continue cooking for 3 minutes. Add in ¼ c red wine and reduce by half.

Place vegetables into the Miele Gourmet Casserole Dish and spread evenly on the bottom of the pan. Allow vegetables to cool.

Season the lamb shanks with salt and freshly cracked black pepper. Place on the vegetables. Distribute the thyme and rosemary evenly in the pan.

Pour in the stock so the top of the lamb shanks are just covered with stock.

Select the MasterChef + program for Lamb Shanks +.

Follow the directions in the display.

### Recommended settings

Gourmet Center \ MasterChef + \ Meat + \ Lamb Shanks +

### Cooking time:

approximately 4 h 5 min

### Tip

Strain cooking liquid and skim fat off of top and serve as au jus. Sauce can be reduced then thickened with a roux or cornstarch slurry.

# Gourmet Center

---

## Veal Rib Roast +

Serves 4-6

### Ingredients

3 lbs veal rib roast, frenched  
2 rosemary sprigs, finely diced  
2 thyme sprigs, finely diced  
Sea salt  
Freshly cracked black pepper  
Olive oil

### Method

Rub rib roast with olive oil, salt and pepper.

In a non-stick sauté pan add in olive oil bring to medium-high heat. Sear meat on all sides.

Insert roast probe into center of the meat and place into a ceramic roasting pan.

Select the MasterChef + program for Veal Rib Roast +.

Follow the directions in the display.

### Recommended settings

Gourmet Center \ MasterChef + \ Meat + \ Veal Rib Roast +

Cooking time:

approximately 2 h 5 min - 4 h 5 min

## Venison Rib Roast +

Serves 4-6

### Ingredients

3 lbs farm raised venison rib roast,  
frenched  
2 rosemary sprigs, finely diced  
2 thyme sprigs, finely diced  
Sea salt  
Freshly cracked black pepper  
Olive oil

### Method

Rub rib roast with olive oil, salt and pepper.

In a non-stick sauté pan add in olive oil and bring to medium-high heat. Sear meat on all sides.

Insert roast probe into center of the meat and place into a ceramic roasting pan.

Select the MasterChef + program for Venison Rib Roast +.

Follow the directions in the display.

### Recommended settings

Gourmet Center \ MasterChef + \ Meat + \ Venison Rib Roast +

Cooking time:

approximately 2 h 35 min - 3 h 25 min

# Gourmet Center

---

## Chicken +

Serves 4

### Ingredients

6 lbs chicken

Rosemary

Thyme

Sage

Parsley

Salt

Olive oil

### Method

Pat the chicken completely dry with paper towels.

Place the chicken on the roasting and grilling insert on top of the Miele Universal Tray.

Rub skin with olive oil and season with salt. Stuff the chicken with herbs.

Place the roast probe into the deepest part of the breast.

Select the MasterChef + program for Chicken +.

Follow the directions in the display.

### Recommended settings

Gourmet Center \ MasterChef + \ Poultry + \ Chicken +

Cooking time:

approximately 1 h 35 min - 1 h 45 min



## Duck +

Serves 4

### Ingredients

6 lb whole duck  
2 oranges, skin on, ½ inch diced  
1 large onion, 1 inch dice  
2 garlic cloves  
1 rosemary sprig  
Salt, to taste  
Olive oil  
½ c chicken broth

### Recommended settings

Gourmet Center \ MasterChef + \ Poultry +  
\ Duck +

Cooking time:  
approximately 2 h 35 min

### Method

Pat the duck completely dry with paper towels.

With a fork, poke holes into the skin but do not poke into the meat. Start at the top of the breast and work all the way down to the legs, poking holes every eighth of an inch apart from each group. The more holes the better.

Stuff the duck with the orange, garlic and rosemary. With oven safe toothpicks, seal the cavity so the stuffing does not fall out.

Rub the duck with olive oil and salt to taste. Place duck on top of onions in a ceramic oval roasting pan.

Pour ½ c chicken broth around the duck, avoiding getting any liquid on the skin.

Select the MasterChef + program for Duck +.

Follow the directions in the display.

# Gourmet Center

---

## Turkey +

Serves 8

### Ingredients

15 lb whole turkey

Rosemary

Thyme

Parsley

Salt

Olive oil

### Method

Pat the turkey completely dry with paper towels.

Place turkey into roasting pan and stuff with herbs.

Rub skin with olive oil and season with salt.

Place the roast probe into the deepest part of the breast.

Select the MasterChef + program for Turkey +.

Follow the directions in the display.

### Recommended settings

Gourmet Center \ MasterChef + \ Poultry + \ Turkey +

Cooking time:

approximately 1 h 30 min - 2 h 15 min

## Coquilles St. Jacques +

Serves 4-8

### Ingredients

Eight 1 oz fresh diver scallops  
8 scallop shells

### Cheese Sauce

½ c gruyere cheese, finely grated  
½ c heavy cream  
½ tsp butter  
2 tsp all-purpose flour  
Salt to taste

### Mushroom Filling

¼ c shallots, finely diced  
1 c cremini mushrooms, finely diced  
1 clove garlic, finely diced  
1 tbsp dry white wine  
Salt to taste

### Bread Crumb Topping

2 tbsp butter  
2 garlic cloves whole  
½ c unseasoned panko bread crumbs  
Salt to taste

### Cheese Sauce

In a small sauce pan add butter on medium heat. When the butter is fully melted, whisk in all purpose flour, and continue cooking for about 3 minutes. While whisking, slowly drizzle in heavy cream. Cook until thickened. Continue whisking and add in the gruyere cheese. Finish cooking the sauce on low heat while whisking vigorously until the starch taste has gone away. Set aside to cool.

### Mushroom Filling

In a non-stick sauté pan add butter on medium heat. When butter is melted add in shallots and sweat until translucent. Stir in garlic and cook until aromatic. Add in mushrooms and sauté on high heat until the mixture starts to stick to the pan. Deglaze with white wine. Cook for about 1 minute, until the wine has evaporated. Set aside to cool.

### Bread Crumb Topping

Melt butter on medium heat. Stir in garlic, cook until aromatic on medium low heat. Remove garlic cloves. Add bread crumbs into butter and stir until combined. Set aside to cool.

### Assembly

Line the Miele Universal Tray with scallop shells. Spoon in mushroom filling. Next cover the mushrooms with the cheese sauce. Place a scallop on top and then cover the scallop with cheese sauce. Lastly, sprinkle with the bread crumb mixture on top.

Select the MasterChef + program for Coquilles St. Jacques +.

Follow the directions in the display.

### Recommended settings

Gourmet Center \ MasterChef + \ Shellfish + \ Coquilles St. Jacques +

Cooking time:

approximately 35 min

# Gourmet Center

---

## Lobster Tails +

Serves 6

### Ingredients

Six 6 oz lobster tails

½ lb salted butter, melted

Lemon wedges

### Method

Take the defrosted lobster tails and cut the top of the lobster tail open with kitchen shears until you reach the feathered end of the tail.

Spread the shell apart and devein the lobster tail. Rinse tail under cold water.

Lay all six lobster tails on the Miele Universal Tray.

Select the MasterChef + program for Lobster Tails +.

Follow the directions in the display.

Serve the traditional way with melted butter and lemon wedges.

### Recommended settings

Gourmet Center \ MasterChef + \ Shellfish + \ Lobster Tails +

Cooking time:

approximately 23 minutes

### Tip

Shock lobster tails in ice water. Cut in half and serve cold with other shellfish and cocktail sauce as an appetizer.

## Oysters Rockefeller +

Serves 4-6

### Ingredients

16 oysters  
4 c baby spinach  
½ c celery, 1/8 inch dice  
½ c fennel bulb, 1/8 inch dice  
¼ c onions, 1/8 inch dice  
2 tbsp heavy cream  
1 tbsp butter  
Parmesan cheese, shredded, enough to  
sprinkle on all oysters  
1 tsp olive oil

### Method

Wash and shuck all the oysters. Save bottom shells and strain all the liquid into a bowl.

Place shucked oysters on a dinner plate and cover with plastic wrap. Place into refrigerator.

Place 1 tsp olive oil into a non-stick pan. Add in baby spinach, cook until just wilted. Finely chop and reserve. Allow spinach to cool.

In the same non-stick pan add butter and when melted add onions and sweat until translucent.

Next add the celery and the fennel. Cook until slightly soft, about 5 minutes. Add in the juice from the oysters and reduce until evaporated.

Mix all the vegetables together and add in the heavy cream.

To assemble, place the oyster shells on the Miele Universal Tray. Place a shucked oyster into each one. Next, spoon in the vegetable filling into all of them. Sprinkle the top with parmesan cheese.

Select the MasterChef + program for Oysters Rockefeller +.

Follow the directions in the display.

### Recommended settings

Gourmet Center \ MasterChef + \ Shellfish + \ Oysters Rockefeller +

Cooking time:  
approximately 25 min

# Favorites

---

You can create and save up to 20 of your own programs.

- Each one can have up to 10 cooking stages. This enables you to save your most frequently used recipes very accurately. In each stage you can select settings such as mode, temperature and duration or core temperature.
- You can specify the shelf level(s) for the food.
- You can enter a program name for your recipe.

When you next select the program, it will start automatically.

There are different ways of creating a Favorite:

- At the end of running a MasterChef Program, save it as a separate program.
- After running a program with a set duration, select **Save**.

Then name the program.

## Creating a Favorite

- Select **Favorites** .
- Select **Create Program**.

You can now specify the settings for the first cooking stage.

Follow the instructions in the display:

- Select and confirm the settings.

Depending on the mode selected you can add the **Rapid PreHeat** and **Crisp** function in **Additional Settings**.

The settings for the first cooking stage have now been set.

More cooking stages can be added, for example, if you would like to add another cooking mode to follow the first.

- If additional cooking stages are required, select **Add** and proceed as you did for the first cooking stage.
- When you have completed setting the cooking stages, select **Finish**.

Set the shelf level(s) to be used:

- Select the desired level(s).
- Confirm with **OK**.

A summary of your settings will appear in the display.

- Check the settings and select **OK** to confirm, or select **Change** to correct the settings.
- Select **Save**.
- Enter the program name using the keyboard.

You can add a line break for longer program names using the  symbol.

- Once you have entered the program name, select *Save*.

A message will appear on the display confirming that the name has been saved.

- Confirm with *OK*.

You can start the saved program immediately, delay the start, or change the cooking stages.

More information regarding *Change Cooking Stages* can be found in "Changing Favorites".

## Starting a Favorite

- Place the food in the oven.
- Select Favorites .

The program names will appear in the display.

- Select the desired program.

You can start the saved program immediately, delay the start, or show the cooking stages.

- Start Now  
The program will start immediately. The oven heating will turn on immediately.
- Start Later  
This option only appears when you are using the roast probe. You can set the time at which the cooking program should start. The oven will turn on automatically at the time you have set.

- Ready at  
You can set the time at which the cooking program should end. The oven will turn off automatically at the time you have set.
- Start at  
You can set the time at which the cooking program should start. The oven will turn on automatically at the time you have set.
- Display Cooking Stages  
A summary of your settings will appear in the display. You can adjust the settings under *Change* (see "Changing Favorites").
- Select the desired menu item.
- Confirm the message regarding which shelf level to use with *OK*.

The selected program will begin automatically right away or at the time set.

## Changing Favorites

### Changing cooking stages

Cooking stages in automatic programs that have been saved under a different name cannot be changed.

- Select Favorites .

The program names will appear in the display.

- Select *Edit*.
- Select *Change Program*.
- Select the desired program.
- Select *Change Cooking Stages*.

# Favorites

---

The setting specified for a cooking stage can be changed or more cooking stages can be added to the program.

- Change the program as desired (see “Creating a Favorite”).
- Check the settings and confirm with *OK*.
- Select *Save*.

The changes made to the program will be saved.

## Changing the name

- Select Favorites .

The program names will appear in the display.

- Select *Edit*.
- Select *Change Program*.
- Select the desired program.
- Select *Change name*.
- Change the name (see “Creating a Favorite”) and select *Save*.

A message will appear in the display confirming that the name has been saved.

- Confirm with *OK*.

The new program name will be saved.

## Deleting a Favorite

- Select Favorites .

The program names will appear in the display.

- Select *Edit*.
- Select *Delete Program*.
- Select the desired program.
- Confirm with *OK*.

The program is deleted.





You can delete all of your Favorites at the same time (see “Settings – Factory Default – Favorites”).



Eating food which has been cooked correctly is important for good health.





Only bake cakes, pizza, french fries, etc. until they are golden brown. Do not overcook them.

## Oven modes

Depending on how you would like the food prepared, you can use Convection Bake , Intensive , Moisture Plus  or Surround .

## Bakeware

The bakeware used depends on the oven mode chosen and how the food is being prepared.

- Convection Bake , Intensive , Moisture Plus : baking tray, universal tray, any heat-resistant baking dish.
- Surround : Dark metal, enamel, or aluminum bakeware with a matte finish, as well as heat-resistant glass, ceramic, and coated bakeware can be used. Avoid using bright, shiny metal bakeware; it gives an uneven and poor browning result and in some cases cakes might not cook properly.

- Always place bakeware on the rack. Position rectangular pans with the longer side across the width of the rack. This will allow for optimum heat distribution and even baking results.
- When baking cakes with fruit toppings or deep cakes, place the pan on the universal tray to catch any spillages.

## Parchment paper / Greasing the pan

All Miele accessories (baking tray, universal tray, perforated baking tray and round baking dish) are treated with PerfectClean finish.

Surfaces treated with PerfectClean finish generally do **not** need to be greased or covered with parchment paper.

Parchment paper is only needed with:

- anything with a high salt content (e.g. pretzels, bread sticks), because sodium can damage the PerfectClean surface;
- meringues or dishes with a high egg-white content, because they are more likely to stick,
- frozen food cooked on the wire oven rack.

# Bake

---

## Temperature

Select the suggested temperature if possible.





Choosing a baking temperature higher than those recommended may reduce the cooking time, but will lead to uneven browning, and unsatisfactory cooking results.

## Baking duration

Check if the food is cooked at the end of the shortest duration quoted. To check if a cake is ready insert a wooden skewer or toothpick into the center, it should come out clean.

## Shelf levels





The shelf level that you place the food on for baking depends on the oven mode and the number of trays being used.

- **Convection Bake** 
  - 1 Tray: Level 3
  - 2 Trays: Levels 1+3/2+4
  - 3 Trays: Levels 1+3+5
- **Moisture Plus** 
  - 1 Tray: Level 3
- **Intensive Bake** 
  - 1 Tray: Level 2 or 3
- **Surround** 
  - 1 Tray: Level 3

Bake moist cakes and muffins on a maximum of two levels at the same time.

Always observe the USDA guidelines for food safety.

## Oven modes

Depending on how you would like the food cooked, you can use Convection Bake / Convection Roast , Moisture Plus , Auto Roast , Surround / Surround Roast  or a MasterChef program.

## Cookware





Any heat-resistant cookware can be used:

Wire oven rack, grilling and roasting insert (if available) on the universal tray, roasting pans, heat-resistant glass/earthen/cast iron dishes, roasting bags

## Temperature

Select the suggested temperature if possible.

If higher temperatures are used, the meat will brown on the outside, but will not be properly cooked through.

When cooking with Convection Bake / Convection Roast , Moisture Plus  or Auto Roast , select a temperature that is approx. 25°F (20°C) lower than the temperature for Surround / Surround Roast .

## Shelf levels

In most cases level 3 should be used. With large items, such as a turkey, use level 1 or 2.

## Tips

- Resting time: At the end of the program, take the roast out of the oven, cover with aluminum foil and let stand for about 10 minutes. This helps retain the juices when the meat is sliced.
- The larger the cut of meat, the lower the temperature setting should be.
- Use a roast probe for accurate cooking temperatures and best results.

# Roast

## Roast probe

Danger of injury! The metal tip of the roast probe can cause injury.

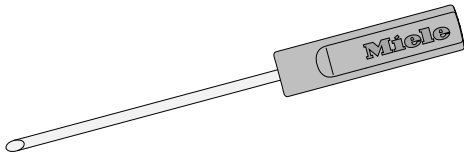

The wireless roast probe enables the roasting process to be monitored simply and reliably. It is dishwasher-safe.

### How it works

The metal tip of the roast probe must be inserted into the center of the food. It contains four temperature sensors. The sensors measure the core temperature inside the food during the cooking process.

They are designed to monitor the rise in temperature in the coldest part of the food. The coldest part is usually in the center (core) of the food. The four temperature sensors are arranged in the metal tip so that the measured values they provide can be used to calculate the temperature in the coldest part of the food. This is still possible even if the metal tip is not located exactly in the core of the food.

The rise in the core temperature reflects the extent to which the food is cooked. You can program the core temperature to be lower or higher, depending on whether you want your meat to be rare, medium, or well done.

The maximum core temperature setting is 210 °F (99 °C). Please refer to the roasting chart and the “Slow Roasting” section for information about the types of meat and the corresponding core temperatures.

The cooking time will be similar when cooking with or without the wireless roast probe.

The core temperature value is sent via radio signal from the transmitter in the handle of the wireless roast probe via the antenna in the top right of the oven to the electronic module of the appliance as soon as the food is put in the oven with the roast probe inserted.







Efficient radio transmission is only guaranteed if the oven door is closed. If the door is opened during a cooking process, e.g., to baste the food, radio signal transmission is interrupted. It will only resume when the door is closed. It will take a few seconds before the current core temperature appears again in the display.

If you do not intend to use the wireless roast probe, do not leave it in the oven while cooking. Always put it in the storage sleeve.

## When to use the roast probe

Some MasterChef programs and Special Modes will prompt you to use the roast probe.

You can also use it with your own Favorite programs and with the following functions:

- Auto Roast 
- Convection Bake / Convection Roast 
- Intensive 
- Surround / Surround Roast 
- Moisture Plus 
- Convection Broil 

## Important notes regarding the roast probe

To ensure the probe works correctly, please observe the following instructions.

- Do not use deep, narrow, metal cooking containers, as these will weaken the radio signal.
- Do not place any metal objects such as lids or aluminum foil above the wireless roast probe. Do not use the wire oven rack or universal tray on a shelf level above the food containing the roast probe. Glass lids may be used.
- Do not use another standard metal cooking thermometer when using the wireless roast probe.
- Do not allow the handle of the wireless roast probe to sit in any sauce or cooking liquid, or to rest on the food or the edge of the cooking container.

 Risk of breakage!  
Do not use the wireless roast probe to lift or carry the food.

# Roast

In addition please note:

- The meat can be placed in a pot or on the universal tray and wire oven rack.
- The metal tip of the roast probe must be inserted into the center of the food so that the temperature sensors reach the core. The handle should be angled upwards. **Make sure that the handle is not horizontal, facing the door, or the corners of the oven interior.**

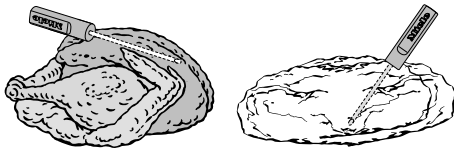

- When cooking poultry, insert the metal part into the thickest part of the breast. You can find the thickest part of the breast by pressing the area with your thumb and index finger.
- The metal tip must not touch any bone or be inserted in areas with a lot of fat. Fatty tissue and bones can cause the probe to switch off early.
- If the meat contains heavy marbling, select the highest core temperature stated in the roasting chart.
- When using roasting bags or aluminum foil, insert the probe through the bag or foil into the center of the meat. You can also place meat inside the bag or foil with the probe already inserted. Be sure to follow the instructions provided by the manufacturer of the roasting bag or aluminum foil.

- The wireless roast probe can only be inserted horizontally into flat foods such as fish.

If the wireless roast probe is no longer recognized during cooking, a message will appear in the display. Reposition the roast probe in the food.

In some cases, reception interference can even be caused by a microwave operating in the vicinity of the oven, because the microwave uses a similar frequency range to that of the wireless roast probe. Turn off the microwave when you are using the wireless roast probe.

## Using the roast probe

Danger of injury! The metal tip of the roast probe can cause injury.

- Remove the roast probe from its storage sleeve.
- Insert the metal tip of the roast probe into the food. The handle should be pointing up diagonally.
- Place the food in the oven.
- Close the door.
- Select an oven mode or MasterChef automatic program/MasterChef Plus automatic program.

The message *Continue cooking with the roast probe?* will appear.

- Select *Yes*.
- Adjust the recommended temperature, if necessary.
- Change the default core temperature, if necessary.

Core temperatures cannot be changed for MasterChef automatic programs/MasterChef Plus automatic programs.

You can also delay the start of the cooking program to a later time. To do this select *Additional Settings* and set a time in the *Start at field*. In MasterChef automatic programs/MasterChef Plus automatic programs, select *Start Later*.

You can estimate approximately when the food will be ready as the duration of the cooking program is about the same as if you were cooking food without using the roast probe.

*Duration* and *Ready at* cannot be set because the total time depends on how long it takes for the core temperature to be reached.

## Time-left display

If the temperature set for a cooking process is above 285°F (140°C), the estimated duration remaining (time left) will appear in the display.

The time left is calculated from the cooking temperature selected, the set core temperature, and the progress of the core temperature as it rises.

The time left first shown is an estimate. As the cooking process continues, the time left is revised continuously, and a more accurate figure is shown.

The time left will be deleted if the cooking or core temperature is changed or if a different mode is selected. If the door is opened for a longer time, the time left will be recalculated.

# Roast

---

## Displaying the core temperature

As soon as the time left appears, you can also display the actual core temperature.

- Select **Change**.
- Select **Display core temperature**.
- Select **On**.
- Confirm with **OK**.

The actual core temperature will also appear in the display.

## Residual heat utilization

The oven heating turns off shortly before the end of the cooking process. The residual heat in the oven is sufficient to complete the cooking process.

Using the residual heat in the oven saves energy.

**Energy Save Phase** will appear in the display to show that the oven is in energy save mode. The measured core temperature is no longer visible.

The cooling fan and convection fan (if turned on) will continue to run.

When the selected core temperature has been reached:

- **Program Finished** appears.
- The buzzer will sound if it has been turned on (see “Settings – Volume – Buzzer tones”).

**Tip:** If the food is not sufficiently cooked, insert the roast probe in a different place and repeat the program.



This cooking method is ideal for cooking beef, pork, veal or lamb when a tender result is desired.

First, using a cooktop sear the meat on all sides to seal in the juices.

Then place the meat in a preheated oven. It will be cooked at a low temperature for an extended time allowing the meat to become very tender.

The meat will rest and the juices start to circulate evenly throughout.

This gives the meat a very tender and juicy result.

## Tips

- Use fresh, lean meat that has been trimmed. Remove the bones before cooking.
- When searing, use a suitable cooking oil or fat that can withstand high temperatures (e.g. clarified butter, vegetable oil).
- Do not cover the meat during cooking.

Cooking will take approx. 2-4 hours, depending on the size and weight of the meat, as well as the desired degree of doneness and browning.

## Cooking time 🕒 / Core temperatures 🔥

Always observe USDA food safety guidelines.

| Meat               | 🕒<br>[min] | 🔥<br>°F / °C |
|--------------------|------------|--------------|
| Beef Tenderloin    | 80–100     | 138/59       |
| Sirloin            |            |              |
| – rare             | 50–70      | 118/48       |
| – medium           | 100–130    | 135/57       |
| – well done        | 160–190    | 156/69       |
| Pork tenderloin    | 80–100     | 145/63       |
| Smoked pork chop * | 140–170    | 154/68       |
| Filet of veal      | 80–100     | 140/60       |
| Veal loin *        | 100–130    | 145/63       |
| Saddle of lamb *   | 50–80      | 140/60       |

\* boneless

## After cooking:

Because the cooking temperatures are very low:

- The meat can be carved immediately. No resting time is required.
- The cooking result will not be affected if the meat is left in the oven after the program is complete. It can be kept warm until you serve it.
- The meat is at an ideal temperature to be eaten right away. Serve on pre-warmed plates with a hot sauce or gravy to keep warm.

# Slow Roasting

---

## Using “Slow Roasting” special mode

For more information, see “Roast - Roast probe”.

- Select Special Modes .
- Select Slow Roasting.
- Set the temperature.
- Set the core temperature.
- Follow the instructions in the display. Let the wire oven rack and universal tray preheat in the oven.
- While the oven is preheating, sear the meat on all sides on the cooktop.



**Danger of burning!**

When the oven is hot use pot holders to insert, remove, or turn food, as well as when adjusting the oven shelves, etc.

- Once Use the roast probe appears in the display, place the seared meat on the rack and insert the roast probe so that the metal tip is fully in the center of the meat.



**Danger of burning!**

The browning/broiling element is hot.

- Close the door.

When the program is completed Program Finished will appear in the display and the buzzer will sound if it has been turned on (see “Settings – Volume – Buzzer tone”).

If the meat is not cooked to your satisfaction, you can extend the cooking time.

## Adjusting the Slow Roasting temperature

Use the wire oven rack with the universal tray positioned on top. Do not use the Rapid PreHeat function to preheat the oven.

- Slide the universal tray and rack onto shelf level 3.
- Select Operating Modes.
- Select the Surround  mode and set the temperature to 265°F (130°C).
- Turn off the Rapid PreHeat function by selecting Change – Additional Settings – Rapid PreHeat – Off.
- Preheat the oven with the universal tray and wire oven rack for approx. 15 minutes.
- While the oven is preheating, sear the meat on all sides on the cooktop.

### Burn hazard!

Use pot holders when inserting, removing or turning hot food, or when adjusting shelves, etc. in a hot oven.

- Place the seared meat on the wire oven rack.
- Select Change.
- Reduce the temperature to 210°F (100°C).
- Allow the meat to finish cooking.

You can set the cooking program to switch off automatically (see “Additional functions - Setting the cooking time”).

# Broil



**Danger of burns!**

Broil with the oven door closed. If you broil with the door open the hot air will escape from the oven before it has been cooled by the cooling fan.

The controls will get hot.

## Oven modes

### Maxi Broil

This mode delivers excellent browning and broiling results when cooking larger amounts of food. Use to broil chops, ribs and large quantities of meat and for browning large dishes.

The entire Browning/Broiling element will become red hot to produce the necessary heat.

### Broil

This mode delivers excellent browning and broiling results when cooking smaller amounts of food. Use to broil chops, ribs and small quantities of meat and for browning small dishes.

Only the center of the Browning/Broiling element will become red hot to produce the necessary heat.

### Convection Broil

For broiling thicker items, e.g. poultry or London broil.

The Browning/Broiling element and the fan switch on in alternating phases.

## Cookware

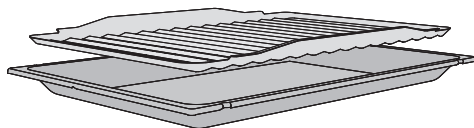

Use the universal tray with the grilling and roasting insert (if available), and place the tray in the oven. The insert prevents any collected meat juices from burning, allowing them to be used for gravy and sauces.

## Temperature

As a general rule, select the default temperature.

If higher temperatures are used, the meat will brown on the outside, but will not be properly cooked through.

## Preheating

Always preheat the oven for about 5 minutes with the door closed before Broiling.

## Shelf levels

Select the shelf level according to the thickness of the food.

- Thin cuts: Shelf level 4 or 5
- Thick cuts: Shelf level 2 or 3

## Broiling time

Flat pieces of fish and meat usually take 6–8 minutes per side.

When broiling thicker pieces, each side will take a bit longer. Make sure that the pieces have roughly the same thickness so that their broiling times do not vary too greatly.

## Testing doneness

Always observe USDA food safety guidelines.

**Tip:** If the surface of a thicker cut of meat is browned but the center is still raw, move the food to a lower level or reduce the temperature and continue cooking. This will stop the surface from becoming too dark.

## Preparing food for broiling

Rinse the meat under cold water and pat dry. Do not season the meat with salt before broiling, this will draw out the juices.

Brush the meat with oil, if necessary. Do not use other types of fat as they can easily burn and cause smoke.

Clean fish as usual. To enhance the flavor, salt or lemon can be added.

## Broil

- Place the grilling and roasting insert (if available) in the universal tray.
- Place the food on top.
- Select the required oven mode and temperature.
- Preheat the Browning/Broiling element for approx. 5 minutes with the door closed.

### Danger of burns!

When the oven is hot use pot holders to insert, remove or turn the food, or when adjusting the oven shelves, etc.

- Place the food on the appropriate shelf level (see the “Broiling chart”).
- Close the door.
- Turn the food halfway through cooking.

## Special Modes

---

In addition to the automatic programs your oven has a variety of special modes.

■ **Select Special Modes** .

The following special modes are available:

- Defrost
- Dehydrate
- Reheat  
(to reheat plated meals)
- Warm-up Cookware
- Proof
- Slow Roasting  
See “Slow Roasting” for more information.
- Pizza
- Sabbath Program

This section also gives information on the following applications:

- Gentle Bake
- Canning
- Frozen food

## Defrost

Use the “Defrost” mode to gently defrost frozen food.

You can select a temperature setting from 75 through 150°F (25 through 50°C).

- Select Special Modes .
- Select Defrost.
- If necessary, adjust the recommended temperature and set the duration.
- Follow the instructions in the display.

Air is circulated throughout the cavity to gently defrost the food.

 Risk of salmonella poisoning!  
Be sure to strictly observe proper hygiene rules when defrosting poultry.  
Do not use the liquid from the defrosted poultry.

## Tips

- Remove the packaging and place the frozen food on the universal tray or in a suitable bowl or dish.
- When defrosting poultry, place it on the wire oven rack and position the rack on the universal tray so that the poultry does not sit in the defrosting liquid.

## Dehydrate

This program is designed for traditional drying of food to preserve it.

The temperature can be set between 175-250°F (80-100°C).

It is important that fruit and vegetables are ripe and not bruised before they are dehydrated.

- Prepare the food for dehydrating.
  - Peel and core apples, and cut into slices 1/4" (.5 cm) thick.
  - Core plums if necessary.
  - Peel, core and cut pears into wedges.
  - Peel and slice bananas.
  - Clean mushrooms, then either halve or slice them.
  - Remove parsley and dill from the stem.
- Distribute the food evenly over the roasting pan.

You can also use the Gourmet perforated baking tray, if you have one.

- Select Special Modes .
- Select Dehydrate.
- If necessary, adjust the recommended temperature and set the duration.
- Follow the instructions in the display.

## Special Modes

| Food       | ⌚ [min] |
|------------|---------|
| Fruit      | 120–480 |
| Vegetables | 180–480 |
| Herbs *    | 50–60   |

### ⌚ Dehydrating time

\* Because this program uses the fan, you should use Surround mode  set to a temperature of 175-250°F (80-100°C) for drying herbs.

- Reduce the temperature if condensation begins to form in the oven.

 **Danger of burning!**  
Use pot holders when removing the food from the oven.

- Allow the fruit or vegetables to cool down after dehydrating.

Dried fruit must be completely dry, but also soft and elastic. Juice should not escape when cut.

- Store in sealed glass jars or tins.

## Reheat

This program is designed for reheating plated meals and uses added moisture.

The available options are:

- Pizza
- Large roasting pan
- Bakes

Use heat-resistant cookware.

- Place the food to be reheated in a dish on the rack. Do not cover.
- Select Special Modes .
- Select Reheat.
- Select the desired dish and adjust the power level.
- Follow the instructions on the display

 **Burn hazard!**  
Use pot holders when removing dishes from the oven. Condensation may accumulate on the bottom of the dish.



## Warm-up Cookware

This program is designed to warm your dishes.

You can select a temperature setting from 75 through 175°F (50 through 80°C).

Use heat-resistant dishes.

- Place the rack on shelf level 3 and place the dishes to be heated on it. Depending on the size of the dishes, you can also place the rack on the oven floor and take the side runners out to make more room.
- Select Special Modes .
- Select Warm-up Cookware.
- If necessary, adjust the recommended temperature and set the duration.
- Follow the instructions in the display.



**Danger of burning!**

Use pot holders when removing dishes. Condensation may accumulate on the bottom of the dishes.

## Proof

This program was designed to proof dough without humidity.

You can select a temperature setting from 75 through 125°F (30 through 50°C).

- Select Special Modes .
- Select Proof.
- If necessary, adjust the recommended temperature and set the duration.
- Follow the instructions in the display.

If you would like to proof dough with the addition of moisture, select the appropriate automatic program.

## Pizza

This program is designed specifically for baking pizza.

You can select a temperature setting from 300 through 475°F (160 through 250°C).

- Select Special Modes .
- Select Pizza.
- If necessary, adjust the recommended temperature and set the duration.
- Follow the instructions in the display.

# Special Modes



---

## Sabbath Program

This mode is designed for religious observance.

Select Sabbath mode and then select the oven mode and temperature.

The program will only start once the door is opened and closed:

- The cooking process will start after about 5 minutes using Surround  or Bake .
- The oven will heat up to the temperature you have set and will maintain this temperature for a maximum of 72 hours.
- The cavity lighting does not come on, even when the door is opened.

If Settings – Lighting – On has been selected, the lighting will remain turned on throughout the program.

- Sabbath Program appears in the display constantly.
- The time of day is turned off.

Once the Sabbath program has started it cannot be changed or saved as a Favorites.

## Using the Sabbath program

The program can only be canceled by turning the oven off.

- Select Special Modes .
- Select Sabbath Program.
- Select the desired mode.

The Sabbath program cannot be started if the timer is being used.

- Set the temperature.
- Confirm with *OK*.

The oven is now ready for use.

Sabbath Program  and the temperature set will appear.

- Open the door to start the program.
- Place the food in the oven.
- Close the door.

The oven heating will turn on after 5 minutes.

To end the program early:

- Turn the oven off.

### Gentle Bake

The Gentle Bake mode is ideal for casseroles and gratins.

You can select a temperature setting from 200-475°F (100-250°C).

- Select Operating Modes .
- Select Gentle Bake and change the default temperature if necessary.
- Follow the instructions on the display.

# Special Modes

## Canning

Always observe USDA food safety guidelines.

### Canning containers

 **Danger of injury!**  
Do not use the appliance to heat up or can food in sealed jars or containers. Pressure will build up inside them and they can explode causing damage to the appliance, as well as the risk of injury and scalding.

Only use jars designed for canning:

- Canning jars
- Jars with twist-off lids

### Canning fruit and vegetables

We recommend using the Convection Bake  mode.

The instructions below are for 6 one-liter glass jars.

- Slide the universal tray onto shelf level 3. Place the jars on the tray.
- Select the Convection Bake  mode and a temperature of 300-340°F (150-170 °C).
- Wait until bubbles rise evenly in the jars.

Then reduce the temperature to avoid a boil-over.

## Fruit / Cucumbers

- As soon as bubbles begin to rise evenly in the jars, reduce the temperature to the lowest setting. Then, leave the jars in the warm oven for an additional 25-30 minutes.

## Vegetables

- Reduce the temperature to 210°F (100°C) as soon as bubbles begin to rise evenly in the jars.
- After the canning time has finished, reduce the temperature to the lowest setting and leave the jars in the oven for an additional 25-30 minutes.

## After canning

 **Danger of burns!**  
Use pot holders when removing the jars from the oven.

- Take the jars out of the oven.
- Cover the jars with a towel and leave to set for approx. 24 hours.
- Make sure all jars are closed properly when storing them.

## Frozen food

### Tips for pizza, French fries, croquettes and other similar items

#### Cakes, pies, pizza, baguettes

- Bake frozen pizza on parchment paper placed on the wire oven rack.
- Cook smaller frozen food items on parchment paper placed on a baking tray or the universal tray.
- For smaller frozen food items, use the lowest temperature recommended on the packaging.
- Turn small frozen food items several times during cooking.

## Preparation

Handling food carefully will help protect your health.

- Select the oven mode and temperatures recommended on the food's packaging.
- Preheat the oven.
- Place the food in the preheated oven on the shelf level recommended on the packaging.
- Check the food at the end of the shortest time recommended on the packaging.

## Cleaning and care

---



**Danger of burns!**

Make sure the heating elements are turned off and allowed to cool completely.



**Danger of injury!** The steam from a steam cleaner could reach electrical components and cause a short circuit.

Do not use a steam cleaner to clean this appliance.

All surfaces can discolor or be damaged if unsuitable cleaning agents are used. The front of the oven, in particular, will be damaged by oven cleaners and descalers.

All surfaces are susceptible to scratches. Scratches on glass surfaces could cause a breakage.

Remove any cleaning agent residues immediately.

### Unsuitable cleaning agents

To avoid damaging surfaces when cleaning, do not use:

- Cleaners containing soda, ammonia, acids or chlorides
- Lime removers on the front of the ovens
- Abrasive cleaning agents, such as scouring powder, scouring cream, pumice stones
- Solvent-based cleaners
- Stainless steel cleaners
- Dishwasher cleaners
- Glass cleaners
- Ceramic cooktop cleaners
- Hard, abrasive sponges and brushes, such as pot scrubbers or used sponges that still contain traces of abrasive cleaner
- Eraser sponges
- Sharp metal scrapers
- Steel wool
- Spot cleaners
- Oven cleaners
- Stainless steel scouring pads

If stains and food residues are allowed to remain on surfaces for a longer period of time, it may no longer be possible to remove them. Continued use without cleaning will make the oven much harder to clean.

Remove any soiling immediately.

The accessories are not dishwasher-safe, with the exception of the wireless roast probe.

### Tips

- Soiling caused by spilt juices and cake mixtures is best removed while the oven is still warm. Use caution and make sure the oven is not too hot - Danger of burns.
- To make cleaning easier you can dismantle the oven door, remove the side runners and lower the Browning/Broiling element.

### Normal soiling

There is a seal around the oven interior which seals the inside of the door.

Take care not to rub, damage or move the gasket.

Do not clean the door gasket - the door gasket is essential for a good seal.

- Remove normal soiling immediately using a clean sponge with warm water and liquid dish soap applied with a clean, damp microfiber cloth.
- After cleaning, ensure that any detergent residue is removed with clean water. This is particularly important when cleaning surfaces treated with PerfectClean enamel as detergent residue can impair the non-stick properties.
- After cleaning, dry the surfaces with a soft cloth.

### Wireless Roast Probe



The wireless roast probe can be cleaned in the dishwasher.

# Cleaning and care

## Stubborn soiling

Do not use a protective coating (i.e. tin foil) to line the oven and do not use commercial oven cleaner unless certified for use in a self-cleaning oven.

Remove coarse soiling from the oven and scrape any burnt-on residues off enameled surfaces with a glass scraper.

Use the Self Clean  program. See “Cleaning the oven interior with Self Clean ” for more information.

Spilled fruit and roasting juices may cause lasting discoloration or matte patches on enameled surfaces. This does not affect the functional characteristics of the finish. Do not attempt to remove these marks. Clean them following the instructions given here.

- Baked on deposits can be removed with a glass scraper or with a non-abrasive steel wool pad, warm water and liquid dish soap.

The cavity does not need to be treated with oven cleaner as it is equipped with a Self Clean  program.

- If necessary, the scouring pad on the back of a non-scratching washing-up sponge can be used to remove the soiling after the holding time.
- After cleaning, remove all oven cleaning agent residues thoroughly with clean water, and then dry the surfaces.



## Cleaning the oven interior with Self Clean

Instead of cleaning the oven by hand, you can use the Self Clean  program.

Any grime that has accumulated will be broken down and burnt to ash as a result of the high temperatures.

This oven has three Self Clean levels, each with a different duration:

- Level 1 for light soiling
- Level 2 for heavier soiling
- Level 3 for very heavy soiling

Once the Self Clean program has started, the door will lock automatically. It cannot be opened again until the program has ended.

You can also set a delayed start time for the Self Clean program, in order to take advantage of off-peak electricity rates, for example.

At the end of the Self Clean program, any remaining residues (e.g., ash) can be easily wiped away.

## Preparing for the Self Clean program

Non-pyrolytic accessories will be damaged by Self Clean. Remove all non-pyrolytic accessories from the oven before starting a Self Clean program. This also applies for optional accessories that are not suitable for the Self clean program.

The following accessories are suitable for cleaning with Self Clean and can remain in the oven during the program:

- Shelf runners
- FlexiClips with wire rack HFCBBR 30-2
- Wire oven rack HBBR 30-2
- Remove all accessories that are not suitable for the Self Clean program from the oven.
- Slide the wire oven rack into the top shelf level.

Heavy soiling in the oven can cause thick smoke to develop and can result in the Self Clean program being switched off. Burnt-on residues can cause lasting discoloration or dull spots on enameled surfaces.

- Before starting the Self Clean program, remove coarse soiling from the oven and scrape any burnt-on residues off enameled surfaces with a glass scraper.

# Cleaning and care

---

## Starting the Self Clean program



**Danger of burning!**

The front of the oven gets hotter in the Self Clean program than it does in normal oven modes.

Do not let children touch the oven during the Self Clean program.

- Select Maintenance
- Select Self Clean.
- Select the Self Clean level required according to the level of soiling.
- Confirm with *OK*.

Follow the instructions in the display.

- Confirm with *OK*.

## Starting the Self Clean program

- To start the Self Clean program immediately, select *Start Now*.
- Confirm by touching *OK*.

The Self Clean program will then start.

The door locks automatically. The oven heating and cooling fan functions are then automatically activated.

The oven light does not come on during the Self Clean program.

The time remaining for the Self Clean program appears in the display. This time cannot be changed.

You can use the timer while the Self Clean program is running. When the set time has elapsed, the buzzer will sound and will flash. The time will then continue to increase in the display.

The buzzer will stop and the visual indicators will go out after you touch the “Timer” sensor.

## Delaying the start of the Self Clean program

- To delay the start of the Self Clean program, select *Start Later*.
- Set the desired time for starting the Self Clean program.
- Confirm by touching *OK*.

The door will lock automatically. *Start at* and the set start time appear in the display.

Up until the start time you can alter the start and end time with *Change*.

As soon as the start time has been reached, the oven heating and the cooling fan will turn on automatically. The duration remaining will appear in the display.

## At the end of the Self Clean program

When the duration remaining reaches 0:00 h, a message will appear in the display to tell you that the door is unlocking.

When the door lock has been deactivated:

- Program Finished appears.
  - The buzzer will sound if it has been turned on (see “Settings – Volume – Buzzer tones”).
- Turn the oven off.

The buzzer will stop and the symbols in the display will go out.

### Danger of burning!

Wait until the oven has cooled down before removing any residual soiling left in the oven compartment after the Self Clean program.

- Wipe any residues (e.g., ash) left behind after the Self Clean program out of the oven compartment and off of any accessories. The amount of ash will vary depending on how dirty the oven was.

Most soiling can be easily removed using a clean, soft sponge and a mild solution of warm water and liquid dish soap.

Depending on how dirty the oven was prior to cleaning, there may be a visible layer of soiling across the inner glass pane on the door. This should be removed using the scouring side of a dish sponge, a glass scraper, or with a stainless steel scrubbing pad and liquid dish soap.

- After the Self Clean program pull the FlexiClips with wire rack apart several times.

### Please note:

- There is a fiberglass seal around the oven interior which seals the inside of the door. Take care not to rub, damage or move the gasket. Do not clean the door gasket - the door gasket is essential for a good seal.
- The FlexiClips with wire rack may appear discolored or a lighter color in places after they have been cleaned. This will not affect the function of the runners in any way.
- Spilled fruit juices may cause lasting discoloration of enameled surfaces. This discoloration is permanent but will not affect the properties of the enamel. Do not attempt to remove these marks.

## Cleaning and care

---

### If the Self Clean program is cancelled

If the Self Clean program is cancelled, the oven door will remain locked until the temperature inside the oven drops to below 535°F (280°C).

The following will cause the Self Clean program to stop:

- Turning the oven off.
- A power failure.

If you turn the oven off Turn appliance off? will appear in the display.

- If you would like to cancel the Self Clean program, select Yes.

The door will unlock once the temperature in the oven has dropped below 535°F (280°C), and the oven is turned off.

- If you would like to continue running the Self Clean program, select No.

The Self Clean program will continue.

Once the power returns after a power failure, Program Canceled Cooling Down will appear in the display.

The door will unlock once the temperature in the oven has dropped below 535°F (280°C), and the oven is turned off.

The buzzer will sound if it has been turned on (see “Settings – Volume – Buzzer tones”).

Program Finished will appear in the display.

- Select ←↵.
- Start the Self Clean program again.

## Door removal

The door weighs approx. 42 lbs (19 kg).

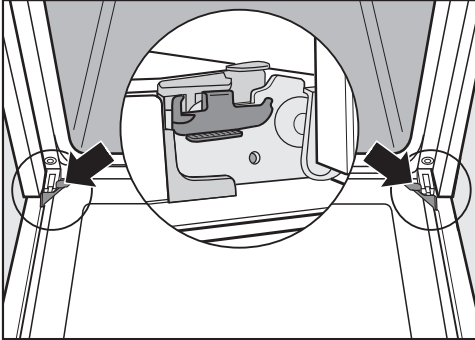

The oven door is connected to the hinges by retainers. Before removing the door from the retainers, the locking clamps on both hinges have to be released.

- Open the door fully.

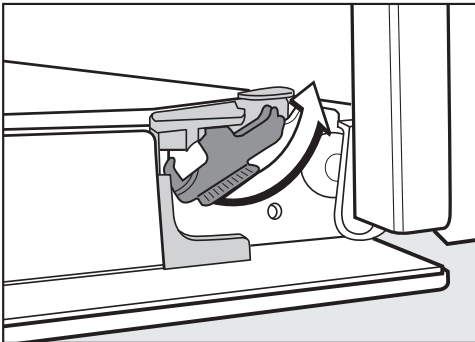

- Release the locking clamps by turning them as far as they will go.

Do not pull the door horizontally off its retainers, as they will spring back against the oven.

Do not pull the door off the retainers by the handle, as the handle could break off.

- Raise the door up till it rests partially open.



- Hold the door on either side and pull it diagonally upwards from the hinge guides. Make sure that you lift the door off straight.

## Cleaning and care

### Reinstalling the door

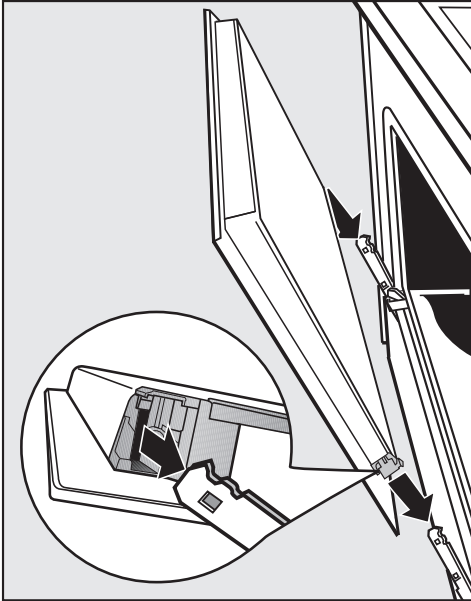

- Hold both sides of the door securely and carefully fit it onto the brackets of the hinges. Make sure that the door goes on straight.

- Open the door fully.

If the locking clamps are not locked, the door can easily become detached from the brackets and be damaged.

You must make sure that the locking clamps are locked again.

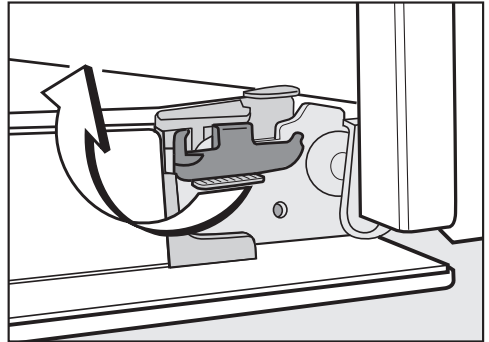

- To relock the locking clamps, turn them back up to the horizontal position as far as they will go.

## Runner removal

The FlexiClips with wire rack must be removed before the shelf runners (see “Features – FlexiClips with rack”).

 **Danger of burns!** Make sure the heating elements are turned off and that the oven cavity is cool.

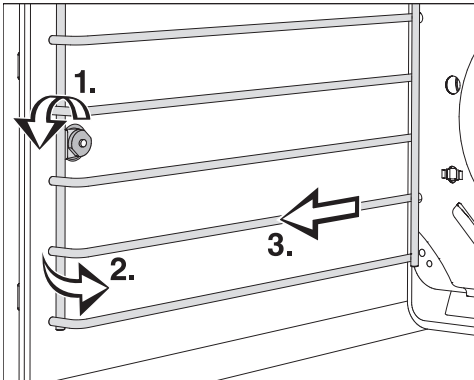

- Loosen the screw (1.).
- Pull the runners out of the holder (2.) at the front of the oven, and then pull them out of the oven (3.).

The runners can be **reinstalled** in the reverse order.





- Be sure that all parts are installed correctly.

## Frequently Asked Questions

---

With the help of the following guide minor faults in the performance of the machine, some of which may result from incorrect operation, can be remedied without contacting the Service Department.

This guide may help you to find the reason for the fault, and how to correct it.



| Problem   | Possible cause and solution   |
|---|---|
| <b>The display is dark.</b>   | <p>The time of day display is deactivated. When the appliance is turned off, the time of day display is turned off.</p> <ul style="list-style-type: none"><li>■ As soon as the oven is turned on, the time of day will appear. If you want it to be displayed continuously, the setting to turn the time of day display back on must be changed (see “Settings – Time of day – Display”).</li></ul> <p>There is no power to the appliance.</p> <ul style="list-style-type: none"><li>■ Check if the breaker has tripped. If it has, contact a qualified electrician or Miele Technical Service.</li></ul> |
| <b>System Lock  appears in the display when the oven is turned on.</b> | <p>The system lock  is activated.</p> <ul style="list-style-type: none"><li>■ You can unlock the oven to start a cooking program by pressing  for at least 6 seconds.</li><li>■ To permanently deactivate the lock, see “Settings - System Lock .</li></ul>  |



## Frequently Asked Questions

| Problem   | Possible cause and solution  |
|---|--|
| <b>The oven does not heat up.</b>                                 | Demo mode is activated.<br>The oven can be operated but will not heat up. <ul style="list-style-type: none"> <li>■ Deactivate Demo mode (see “Settings – Showroom Program”).</li> </ul>  |
| Power Failure - Program Canceled <b>appears in the display.</b>   | There has been a brief power failure which has caused the current cooking process to stop. <ul style="list-style-type: none"> <li>■ Turn the oven off and then back on again.</li> <li>■ Restart the cooking process.</li> </ul>   |
| 12:00 <b>appears in the display.</b>                              | The power supply was interrupted for longer than 200 hours. <ul style="list-style-type: none"> <li>■ Reset the date and time.</li> </ul>   |
| Maximum operating duration reached <b>appears in the display.</b> | The oven has been operating for an unusually long period of time; this has activated the safety shut-off. <ul style="list-style-type: none"> <li>■ Confirm with <i>OK</i>. Clear the message Program Finished by selecting ↵.</li> </ul> The oven is now ready to use again.       |
| ⚠ Fault XX <b>appears in the display.</b>                         | A fault has occurred that you cannot resolve. <ul style="list-style-type: none"> <li>■ Contact Miele Technical Service.</li> </ul>   |
| Door not locked <b>appears in the display.</b>                    | The door lock for the Self Clean program is not locking. <ul style="list-style-type: none"> <li>■ Turn the oven off and then back on again. Then start the required Self Clean program again.</li> <li>■ If the message appears again, contact Miele Technical Service.</li> </ul> |
| Door not released <b>appears in the display.</b>                  | The door lock for the Self Clean program is not unlocking. <ul style="list-style-type: none"> <li>■ Turn the oven off and then back on again.</li> <li>■ If the door lock still does not unlock, contact Miele Technical Service.</li> </ul>                                       |

## Frequently Asked Questions

| Problem  | Possible cause and solution  |
|--|--|
| <p>No signal to roast probe <b>appears in the display.</b></p>   | <p>The roast probe is not being recognized.</p> <ul style="list-style-type: none"> <li>■ Reposition the roast probe in the food.</li> </ul> <p>If the roast probe is still not being recognized, the signal has failed due to another cause.</p> <p>In some cases, reception interference can even be caused by a microwave operating in the vicinity of the oven, because the microwave uses a similar frequency range to that of the wireless roast probe.</p> <ul style="list-style-type: none"> <li>■ Turn off the microwave when you are using the wireless roast probe.</li> </ul> <p>If the roast probe is still not being recognized, it is faulty. You can purchase a new roast probe from your Miele dealer or from Miele Technical Service.</p> |
| <p>Fault with moisture control - the MasterChef programs will operate without moisture <b>appears in the display after a MasterChef + has been selected.</b></p>   | <p>The evaporation system is faulty.</p> <ul style="list-style-type: none"> <li>■ Contact Miele Service.</li> </ul> <p>In the meantime, you can run a program that does not use added moisture.</p>  |
| <p>Fault with moisture control - Moisture Plus program not available <b>appears in the display after selecting Moisture Plus .</b></p> | <p>The steam injection system is faulty.</p> <ul style="list-style-type: none"> <li>■ Contact Miele Technical Service.</li> <li>■ Use the Convection Bake  program instead of Moisture Plus .</li> </ul>   |
| <p><b>A noise is heard after the cooking process is complete.</b></p>  | <p>The fan remains turned on after a cooking program (see “Settings - Cooling fan”).</p>   |
| <p><b>The oven has turned itself off.</b></p>  | <p>The oven turns off automatically if a button is not pressed after a certain amount of time or after a cooking program has ended to save power.</p> <ul style="list-style-type: none"> <li>■ Turn the oven back on.</li> </ul>   |

## Frequently Asked Questions

| Problem   | Possible cause and solution  |
|---|--|
| <p><b>Baked goods are not cooked properly after following the times given in the chart.</b></p> | <p>A different temperature than that given in the recipe was used.</p> <ul style="list-style-type: none"> <li>■ Select the temperature required for the recipe.</li> </ul>   |
|   | <p>The ingredient quantities are different from those given in the recipe.</p> <ul style="list-style-type: none"> <li>■ Double check the recipe. The addition of more liquid or more eggs will make a wetter mixture which will take longer to cook.</li> </ul>  |
| <p><b>The browning is uneven.</b></p>   | <p>The wrong temperature or shelf level was selected.</p> <ul style="list-style-type: none"> <li>■ There will always be a slight unevenness. If the unevenness is great, check whether the correct temperature and shelf level were selected.</li> </ul>   |
|   | <p>That material or color of the bakeware is not suitable for the oven mode selected.</p> <ul style="list-style-type: none"> <li>■ When using Surround  use matte, dark colored pans. Light colored, shiny pans will not produce as desirable results.</li> </ul> |
|   | <p>The catalyzer has been set at too high a level. This can lead to an uneven browning result on more delicate food such as sponge cakes.</p> <ul style="list-style-type: none"> <li>■ Set the odor reduction catalyzer to a lower level or turn it off (see “Settings - Catalyzer”).</li> </ul>   |
| <p><b>The oven lighting turns off after a short time.</b></p>                                   | <p>The oven is factory set to turn off automatically after 15 seconds. This setting can be changed (see “Settings - Lighting”).</p>  |

## Frequently Asked Questions

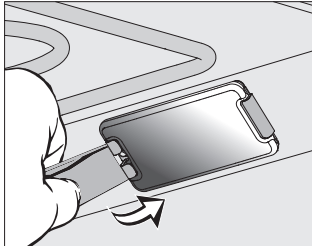
| Problem   | Possible cause and solution  |
|---|--|
| <p data-bbox="73 201 365 256"><b>The oven lighting does not turn on.</b></p>  | <p data-bbox="398 201 874 225">The halogen bulb needs to be replaced.</p> <div data-bbox="404 236 1043 363" style="border: 1px solid gray; padding: 5px;"> <p data-bbox="421 244 667 276">⚠ Danger of burns!</p> <p data-bbox="421 288 1020 344">Make sure the heating elements are turned off and allowed to cool completely.</p> </div> <div data-bbox="404 379 1043 531" style="border: 1px solid gray; padding: 5px;"> <p data-bbox="421 387 925 411">The lamp cover may be damaged if it falls.</p> <p data-bbox="421 424 1003 515">When removing the cover hold it firmly so that it does not fall. Place a towel on the oven floor and open door to avoid damage.</p> </div> <ul data-bbox="398 552 1037 879" style="list-style-type: none"> <li data-bbox="398 552 1014 576">■ Disconnect the appliance from the power supply.</li> <li data-bbox="398 584 1037 639">■ Loosen the bulb cover with the tool supplied at the back of the frame.</li> <li data-bbox="398 647 1009 738">■ Do not touch the halogen bulb with bare fingers. Observe the manufacturer's instructions. Remove the halogen bulb.</li> <li data-bbox="398 746 964 802">■ Replace it with a new halogen bulb (Sylvania 66740, 120 V, 40 W, G9, FS1).</li> <li data-bbox="398 810 874 834">■ Press the bulb cover back into place.</li> <li data-bbox="398 842 953 879">■ Reconnect the oven to the electrical supply.</li> </ul> |
| <p data-bbox="73 895 381 983"><b>There is soiling in the oven after the Self Clean program.</b></p>   | <p data-bbox="398 895 1020 951">The Self Clean program burns off soiling in the oven and leaves it as ash.</p> <ul data-bbox="398 959 1009 1078" style="list-style-type: none"> <li data-bbox="398 959 1009 1015">■ Using a soft sponge, warm water and liquid dish soap remove the ashes.</li> </ul> <p data-bbox="432 1023 964 1078">If coarse soiling remains, start the Self Clean program again with a longer duration.</p>   |
| <p data-bbox="73 1102 353 1158"><b>The oven door cannot be closed.</b></p>  | <p data-bbox="398 1102 986 1254">As soon as the inner pane is damaged, a safety mechanism blocks the oven door. The oven door cannot be closed and the oven functions (oven modes, special modes and self clean) cannot be used.</p> <ul data-bbox="398 1262 897 1286" style="list-style-type: none"> <li data-bbox="398 1262 897 1286">■ Contact the Miele Service Department.</li> </ul>   |

## Frequently Asked Questions

| Problem  | Possible cause and solution   |
|--|---|
| <b>The rack and other accessories make a noise when being pushed into or pulled out of the oven.</b> | <p>The heat resistant surface of the shelf runners creates friction when accessories are taken in and out of the oven.</p> <ul style="list-style-type: none"><li>■ To reduce the friction, lubricate the runners with a few drops of cooking oil applied with a paper towel. Repeat this process after each Self Clean program.</li></ul> |

# Technical Service

---

## Contact in case of fault

In the event of a fault which you cannot remedy yourself, please contact your Miele dealer or Miele Technical Service.

Contact information for Miele Technical Service can be found at the end of this document.

Please quote the model and serial number of your appliance when contacting Miele. Both pieces of information can be found on the data plate.

This information is given on the data plate, visible on the front frame of the oven, with the door fully open.

## Warranty

For further information, please refer to your warranty booklet.

### Disposal of the packing material

The cardboard box and packing materials protect the appliance during shipping. They have been designed to be biodegradable and recyclable.

Ensure that any plastic wrappings, bags, etc. are disposed of safely and kept out of the reach of children.  
Danger of suffocation!

### Disposal of your old appliance

Electrical and electronic appliances contain valuable materials. They also contain certain substances, compounds and components which were essential for the proper functioning and safe use of the equipment. Handling these materials improperly by disposing of them in your household waste can be harmful to your health and the environment. Therefore, please do not dispose of your old appliance with regular household waste and follow local regulations on proper disposal.



Consult with local authorities, dealers or Miele in order to dispose of and recycle electrical and electronic appliances. Miele assumes no responsibility for deleting any personal data left on the appliance being disposed. Please ensure that your old appliance is kept away from children until removal. Observe safety requirements for appliances that may tip over or pose an entrapment hazard.

# Plumbing

---

## Notes on connecting to the water supply

The appliance must be connected to the water supply by a qualified professional.

Disconnect the appliance from the electrical power supply before connecting the water line.

Turn off the water supply before connecting the water lines for the oven.

- All devices used for connecting the appliance to the water supply must comply with the current national and local safety regulations in the country in which the appliance is being installed.
- Hard water, water containing minerals and water from reverse osmosis filtering systems can damage the oven. Only use filtered, softened and demineralized water from the building's plumbing to supply the oven.
- **Connect the oven to a cold water supply only.**
- The oven must only be connected to a water supply with a shut-off valve.
- A water shut-off valve must be provided between the stainless steel hose and the household water supply to ensure that the water supply can be cut off if necessary.
- The water shut-off valve must be accessible after installation.

- The water pressure must be between 14.5 and 145 psi (1 and 10 bar) if the pressure is higher than this, install a pressure reducing valve.
- The stainless steel hose provided has a length of 4' 11" (1.5 m). Longer inlet hoses are available if necessary. Do not shorten the hoses.
- The total hose length must not exceed 24.5 ft (7.5 m).

Ensure that the shut-off valve is accessible after installation.

If the stainless steel hose supplied is damaged, it must only be replaced with an original Miele replacement hose, available from Miele. The hose must be suitable for supplying drinking water.



## Attaching the stainless steel hose to the oven

Make sure that the stainless steel hose is not kinked or damaged. The stainless steel hose must **not** be shortened.

- Remove the cover from the hard water port at the back of the oven.
- Take the angled side of the stainless steel hose and check whether a sealing ring is present. If necessary, insert one.
- Screw the stainless steel hose coupling nut onto the threaded union.
- Ensure that the hose is correctly fitted and that it is water-tight.

- Connect the stainless steel hose to the water supply.

Old or previously used tubing should never be used.

Only use the stainless steel hose supplied.

- Ensure that the hose is correctly fitted and that it is water-tight.
- Slowly open the shut-off valve to the water supply and check for leaks. If necessary, check whether the sealing ring and fittings are tight.

You can now continue with the installation (See "Installation").

## Connecting to the water supply

**Danger of electric shock!**  
Disconnect the oven from the electrical supply before connecting to the water supply.

A faucet with a 3/8" connection thread is required for the connection.

- Check that the sealing ring is present. Replace, if necessary, before connecting the hose to the water supply.

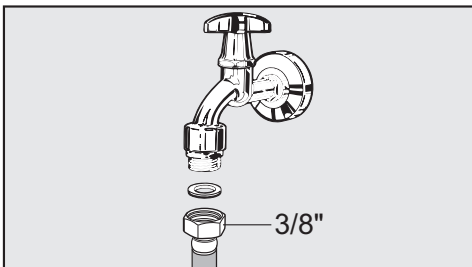

# Electrical connection

---

## CAUTION:

Before servicing, disconnect the power supply by either removing the fuse, shutting off the power main or manually “tripping” the circuit breaker.

Installation, repair and maintenance should be performed by a Miele authorized service technician. Work by unqualified persons could be dangerous and may void the warranty.

Before connecting the appliance to the power supply, make sure that the voltage and frequency listed on the data plate correspond with the household electrical supply. This data must correspond to prevent machine damage. Consult an electrician if in doubt.

Only operate the appliance after it has been installed into cabinetry.

The plug must be inserted into a suitable outlet that has been installed and grounded in compliance with all applicable local regulations.

## **WARNING: THIS APPLIANCE MUST BE GROUNDED**

**Installer: Please pass these instructions on to the customer.**

## **Electrical connection**

The oven is equipped with a power cord approx. 5' 6" (1.7 m) in length with a NEMA 14-30 P plug ready for connection to the power supply:

- 120/208 V, 30 A, 60 Hz
- or
- 120/240 V, 30 A, 60 Hz

The voltage can be adjusted (see “Settings - Electrical Version”).

## **SAVE THESE INSTRUCTIONS FOR THE ELECTRICAL INSPECTOR'S USE.**

## Appliance and cut-out dimensions

Miele ovens can be installed flush or proud. Discuss your installation requirements with your architect, designer and installer.

### Undercounter installation

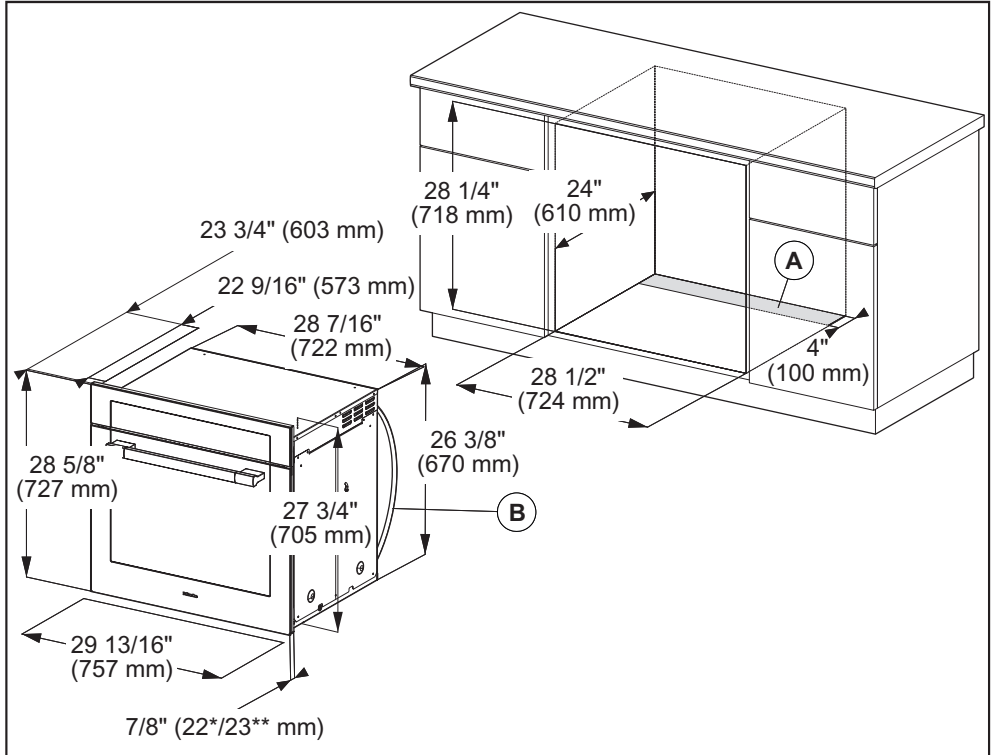

Ⓐ Cut-out (4" x 28 3/8" / 100 mm x 720 mm) in the bottom of the cabinet for power cord and ventilation

Ⓑ Power cord with plug

\* Oven with glass front

\*\* Oven with metal front

Depending on the model, the oven front may differ from the one shown the drawing. Current specifications can be found on the Miele website.

# Installation diagrams

## Installation in a tall cabinet

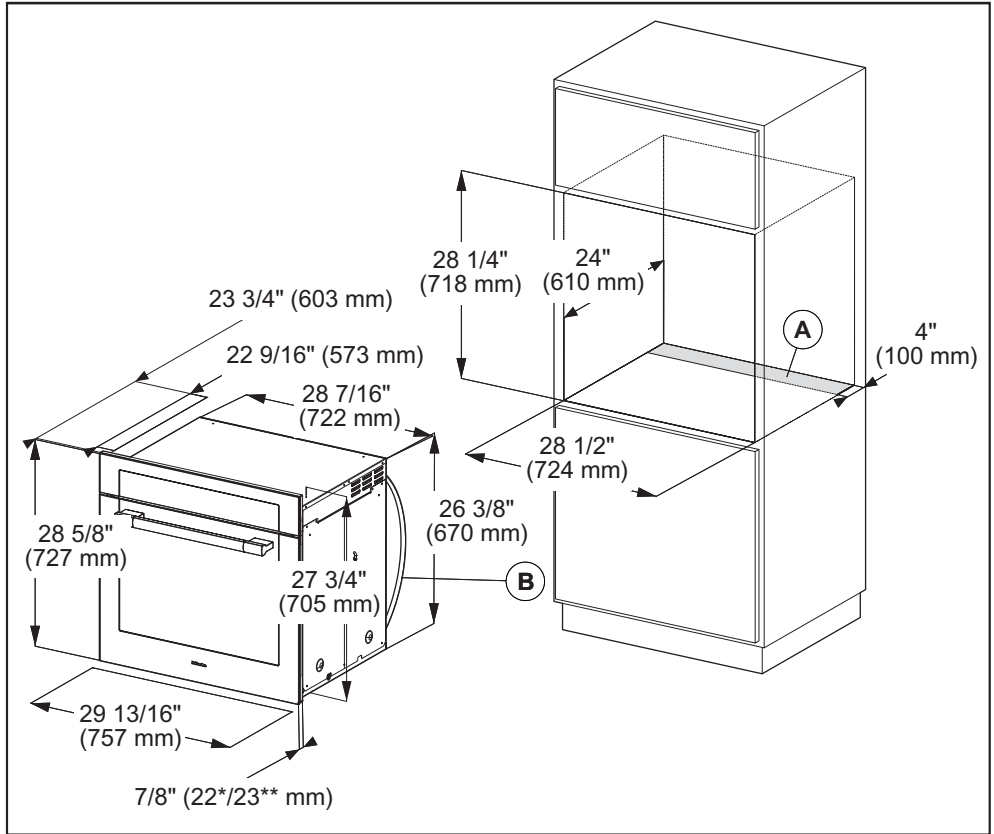

- Ⓐ Cut-out (4" x 28 3/8" / 100 mm x 720 mm) in the bottom of the cabinet for power cord and ventilation
- Ⓑ Power cord with plug

\* Oven with glass front

\*\* Oven with metal front

Depending on the model, the oven front may differ from the one shown the drawing. Current specifications can be found on the Miele website.

# Installing the oven

 The oven must not be operated until it has been properly installed within cabinetry.

The oven must have an adequate supply of cool air for proper operation. The required air must not be heated excessively by other heat sources, e.g. wood burning stove.

Observe the following when installing:

Build into cabinetry with no back wall.

Make sure that the shelf that the oven sits on does not touch the wall. Do not install insulation strips on the side walls of the cabinet housing.

## Before installation

- Before connecting the oven to the power supply, first disconnect the power supply from the oven isolator switch.

## Installing the oven

- Connect the power cord to the electrical supply.

Do not carry the oven by the door handle. The door can be damaged. Use the handles on each side of the oven to carry it.

It is recommended that you remove the door before installing the appliance (see “Cleaning and Care - Removing the door”) and all oven accessories from the cavity. This will make for easier installation into the niche and will not tempt you to use the handle to carry it.

- Remove the side handles, if any.
- Push the oven into the cabinetry and align it.
- Open the door (if it was not removed previously).

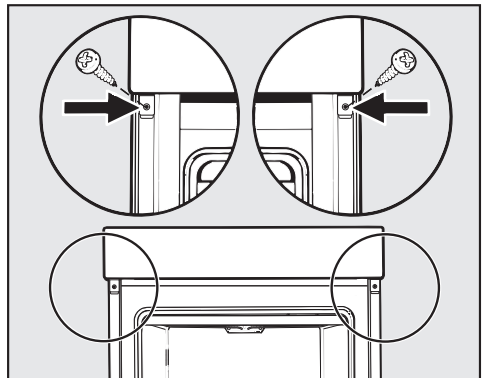

- Use the supplied screws to secure the oven to the side walls of the cabinetry through the holes in the trim.
- Reinstall the door, if necessary (see “Cleaning and care - Installing the door”).

# Copyright and licenses

---

Miele uses software to operate and control the appliance.

The copyright authorization from Miele and other relevant software suppliers (e.g. Adobe) must be respected.

Miele and their suppliers reserve the rights to the software components.

In particular the following are prohibited:

- copying and distribution,
- modifications and derivations,
- decompilation, reverse engineering, disassembling and other such reductions of software.

This product contains Adobe® Flash® Player Software under licence from Adobe Systems Incorporated, Adobe Macromedia Software LLC. Adobe and Flash are registered trademarks of Adobe Systems Incorporated.

Components which fall under GNU General Public Licence and further Open Source licenses are integrated into the software.

An overview of the integrated Open Source components and a copy of the current licence can be obtained at <http://www.miele.com/device-software-licenses>. You will need to enter the specific product name.

Miele will provide the source code for all components of software licensed under the GNU General Public License and comparable Open Source licenses.

For source code requests, please email [info@miele.com](mailto:info@miele.com).

Please have the model and serial number of your appliance available when contacting Technical Service.

---

The Miele logo consists of the word "Miele" in a bold, white, serif font, set against a solid black rectangular background.

## **U.S.A.**

**Miele, Inc.**

### **National Headquarters**

9 Independence Way  
Princeton, NJ 08540  
Phone: 800-843-7231  
Fax: 609-419-4298  
[www.mieleusa.com](http://www.mieleusa.com)

### **Technical Service & Support**

Phone: 800-999-1360  
Fax: 888-586-8056  
[TechnicalService@mieleusa.com](mailto:TechnicalService@mieleusa.com)

### **International Headquarters**

Miele & Cie. KG  
Carl-Miele-Straße 29  
33332 Gütersloh  
Germany

## **Canada**

**Importer**  
**Miele Limited**

### **Headquarters and Miele Centre**

161 Four Valley Drive  
Vaughan, ON L4K 4V8  
[www.miele.ca](http://www.miele.ca)

### **Customer Care Centre**

Phone: 800-565-6435  
905-532-2272  
[customercare@miele.ca](mailto:customercare@miele.ca)

H 6780-2 BP, H 6880-2 BP

en-US, CA

M.-Nr. 11 060 700 / 03