







Operating and Installation Instructions Speed Oven



To prevent accidents and machine damage, read these instructions **before** installation or use.

Contents

IMPORTANT SAFETY INSTRUCTIONS	7
Guide to the Speed Oven	18
Control panel	19
Sensor buttons.....	20
Touch display	22
Symbols	23
Basic operation	24
Features	26
Model numbers	26
Data plate	26
Items included.....	26
Standard and optional accessories	26
Glass Tray	27
Wire rack with non-tip safety notches	27
Speed Oven controls	30
Safety features.....	30
System lock 	30
Safety cut-out	30
Cooling fan.....	31
PerfectClean treated surfaces	31
Before using for the first time	32
General settings	32
Heating the oven.....	34
Settings	35
Accessing the "Settings" menu	35
Changing and saving settings	35
Settings overview.....	36
Language 	38
Time of day	38
Display	38
Clock Type	38
Clock Format	38
Set.....	38
Synchronize	38
Date.....	39
Lighting	39
Start screen.....	39
Brightness	39
Volume	40

Buzzer tones	40
Keypad tone.....	40
Welcome melody	40
Units of measurement.....	40
Weight.....	40
Temperature	40
Minute +	41
Popcorn.....	41
Keeping Warm	41
Cooling fan.....	42
Default temperatures.....	42
Microwave power levels.....	43
Safety	43
System lock 	43
Sensor lock	44
Calibrate temperature	44
Electrical Version.....	44
Showroom Program	45
Demo Mode	45
Factory default	45
MyMiele	46
To add an entry	46
Editing MyMiele	47
Deleting entries	47
Sorting entries.....	47
Alarm + Timer	48
Using the Alarm 	48
Setting the alarm.....	48
Changing an alarm.....	48
Deleting an alarm	48
Using the Timer 	49
Setting the timer	49
Resetting the timer.....	50
Canceling the timer.....	50
Guide to the modes	51
Solo Modes.....	51
Microwave (Solo) 	53
Combination Modes	53
Microwave power	55
How it works	55

Contents

Microwave power levels.....	55
Selecting cookware	56
Containers suitable for microwave use.....	56
Unsuitable containers for microwave use.....	58
Testing dishes for their suitability.....	59
Placing the dish in the Speed Oven.....	60
Lid	60
Energy saving tips	62
Solo modes	63
Quick Guide	63
Cooling fan	63
Additional functions	64
Changing the temperature	64
Rapid PreHeat.....	65
Using the Crisp function (Moisture Reduction).....	66
Changing the oven mode	66
Setting additional durations	67
Microwave (Solo) 	70
Quick Guide	70
Cooling fan	70
Additional functions	71
Changing the microwave power level.....	71
Changing the cooking duration.....	71
Changing the oven mode	71
Setting additional durations	72
Combi Modes	74
Quick Guide	74
Cooling fan	75
Additional functions	75
Changing the microwave power level and temperature	76
Using the Crisp function (Moisture Reduction).....	76
Changing the oven mode	76
Setting additional durations	76
Gourmet Center	77
List of food types	77
Using the Gourmet Center programs.....	77
Notes on using these programs.....	78
Search.....	78

Favorites	79
Creating a Favorite	79
Starting a Favorite	80
Changing Favorites	81
Changing cooking stages	81
Changing the name	82
Deleting a Favorite	82
Minute +	83
Popcorn	84
Bake	85
Roast	87
Roast Probe	89
How the roast probe works	89
When to use the roast probe	89
Important notes regarding the roast probe	90
Using the roast probe	90
Time left display	91
Using residual heat	92
Slow Roasting	93
Using the Slow Roasting function	94
Adjusting the Slow Roasting temperature	95
Broil	96
Microwave: Defrosting/Reheating/Cooking	99
Tables for defrosting, reheating and cooking food using Microwave (Solo) 	102
Table for defrosting food	103
Table for reheating food	104
Table for cooking food	105
Special Modes	106
Defrost	107
Dehydrate	108
Reheat	109
Warm-up Cookware	109
Proof	110
Pizza	110
Sabbath Program	111
Gentle Bake	112

Contents

Canning.....	113
Frozen food	116
Cleaning and care	117
Unsuitable cleaning agents.....	117
Tips	118
Normal soiling	118
Roast Probe	118
Stubborn soiling.....	119
Lowering the Browning / Broiling element.....	120
Frequently asked questions	121
Technical Service	126
Caring for the environment	127
Electrical connection	128
Installation diagrams	129
Appliance and cut-out dimensions.....	129
Installation into a tall cabinet	129
Undercounter installation.....	130
Installation in a tall cabinet in combination with an oven	131
Front dimensions	132
Installation	133
Copyright and licenses.....	134

IMPORTANT SAFETY INSTRUCTIONS

When using the appliance, follow basic safety precautions, including the following:

Read all instructions before installation and use of the oven to prevent accidents and machine damage.

This appliance complies with current safety requirements. Improper use of the appliance can lead to personal injury and material damage.

Read all instructions before installing or using the oven for the first time. Only use the appliance for its intended purpose.

Keep these operating instructions in a safe place and pass them on to any future user.

Use

- ▶ This appliance is intended for residential use only. Use only as described in these operating instructions.
- ▶ This appliance is not intended for outdoor use.
- ▶ The oven is intended for domestic use only: cooking, baking, roasting, broiling, canning, defrosting and reheating of food. Only use this appliance for its intended purpose.
- ▶ Risk of fire! Do not use the speed oven to store or dry items which could ignite easily.
If such items were dried in the Speed Oven, the moisture in the item would evaporate causing it to dry out and even self-ignite.
- ▶ Persons who lack physical, sensory or mental abilities, or experience with the appliance should not use it without supervision or instruction by a responsible person.

IMPORTANT SAFETY INSTRUCTIONS

Children

- ▶ Children should not be left alone or unattended in an area where an oven is in use. Never allow children to operate, sit or stand on any part of the oven. **Caution:** Do not store items of interest to children in cabinets above an oven. Children climbing on the oven to reach these items could be injured.
- ▶ Burn Hazard - Do not allow children to use the oven.
- ▶ As with any appliance, close supervision is necessary when used by children.
- ▶ Danger of suffocation! Ensure that any plastic wrappings, bags, etc. are disposed of safely and kept out of the reach of children.
- ▶ Danger of burns. The oven gets hot at the oven door glass, the vapor vent, the handle and the operating controls. Do not allow children to touch or play in, on or near the oven.

Technical safety

- ▶ This appliance must be installed and connected in compliance with the installation instructions.
- ▶ Installation, repair and maintenance work should be performed by a Miele authorized service technician in accordance with national and local safety regulations and the provided installation instructions. Contact Miele's Technical Service Department for examination, repair or adjustment. Repairs and other work by unauthorized persons could be dangerous and may void the warranty.
- ▶ Before installing the oven, check for externally visible damage. Do not operate a damaged appliance.
- ▶ Operating a damaged appliance can result in microwave leakage and present a hazard to the user. Do not use the appliance if:
 - the door is warped,
 - the door hinges are loose,

IMPORTANT SAFETY INSTRUCTIONS

- holes or cracks are visible in the housing, the door, the door seal or the oven interior walls.
- ▶ To guarantee the electrical safety of this appliance, continuity must exist between the appliance and an effective grounding system. This appliance must be grounded. Connect only to properly grounded outlet. See "Electrical connection - GROUNDING INSTRUCTIONS". It is imperative that this basic safety requirement be met. If there is any doubt, have the electrical system of the house checked by a qualified electrician.
- ▶ Before installation, make sure that the voltage and frequency listed on the data plate correspond with the household electrical supply. This data must correspond to prevent injury and machine damage. Consult a qualified electrician if in doubt.
- ▶ Before installation or service, disconnect the power supply to the work area by
 - removing the fuse,
 - "tripping" the circuit breaker, or
 - unplugging the unit. Pull the plug not the cord.
- ▶ Extension cords do not guarantee the required safety of the appliance (e.g. danger of overheating). Do not use an extension cord to connect this appliance to electricity.
- ▶ The oven is not to be operated until it has been properly installed within cabinetry.
- ▶ Danger of electric shock!
Under no circumstances open the outer casing of the appliance.
- ▶ This appliance must not be used in a non-stationary location (e.g. on a ship).
- ▶ Do not repair or replace any part of the appliance unless specifically recommended in the operating instructions. All other servicing should be referred to a qualified technician.

IMPORTANT SAFETY INSTRUCTIONS

- ▶ Defective components should be replaced by Miele original spare parts only. Only with these parts can the manufacturer guarantee the safety of the appliance.
- ▶ In order for the oven to function correctly, it requires an adequate supply of cool air. Ensure that the air flow is not impaired (e.g. insulation in the cabinetry). Also be sure that the cool air supply is not heated by other sources nearby.
- ▶ If the oven is installed behind a cabinet door, do not close the door while the oven is in operation. Heat and moisture can build up behind the closed door and cause damage to the oven, cabinetry and flooring. Do not close the door until the oven has completely cooled down.

Proper use



Danger of burns!

The Speed Oven becomes hot when in use.

Depending on the mode selected, you could burn yourself on the heating elements, oven interior, cooked food or oven accessories.



Wear pot holders when placing food in or removing food, or when making adjustments in the hot Speed Oven.

- ▶ **Caution:** Heating elements may be hot even though they are not glowing. Interior surfaces of an oven become hot enough to cause burns. External parts of the oven such as the door glass, vents, and the control panel can become hot. During and after use, do not touch, or let clothing or other flammable materials come into contact with heating elements or interior surfaces of the oven until they have had sufficient time to cool.
- ▶ Do not let food sit in the oven more than one hour before or after cooking. Doing so can result in food poisoning or sickness.

IMPORTANT SAFETY INSTRUCTIONS

- ▶ It is important that the heat is allowed to spread evenly throughout the food being cooked. This can be achieved by stirring and/or turning the food, and observing a sufficiently long standing time, which should be added to the time needed for cooking, reheating or defrosting.
- ▶ Use only dry, heat-resistant potholders. Moist or damp potholders used on hot surfaces may result in steam burns. Do not let potholders come in contact with oil or grease. Do not substitute dish towels or other bulky items for potholders. Do not let potholders touch hot heating elements.
- ▶ Loose fitting or hanging garments present a fire hazard. Wear proper apparel while operating the appliance.
- ▶ Do not heat unopened containers of food in the oven, pressure may cause the containers to burst and result in injury.
- ▶ To prevent burns, always place oven racks at their desired height while the oven is cool. If the rack must be moved while the oven is hot, do not let pot holders touch hot heating elements.
- ▶ Open the door carefully to allow hot air or steam to escape before placing or removing food.
- ▶ To prevent burns, allow the heating elements to cool before cleaning by hand.
- ▶ Do not leave the oven door open unnecessarily as someone may trip over it or be injured by it.
- ▶ Never leave the appliance unattended when cooking with oil or fat. They can ignite if overheated. Do not use the oven for frying. Do not use water on grease fires. Turn off the Speed Oven immediately and suffocate the flames by keeping the door closed.
- ▶ Never store flammable liquids and materials in, above or under an oven, or near cooking surfaces.

IMPORTANT SAFETY INSTRUCTIONS

- ▶ To avoid fueling any flames, do not open the Speed Oven door if smoke occurs inside the appliance. Interrupt the process by turning the appliance off and disconnecting it from the power. Do not open the door until the smoke has dissipated.
- ▶ Do not use the oven to heat the room. The high temperatures radiated could cause objects near the oven to catch fire.
- ▶ Please be aware that durations when using microwave power are often considerably shorter when cooking, reheating and defrosting than when using modes without microwave power. Excessively long cooking times can lead to food drying out and burning or could even cause it to catch fire.
Be sure you keep to recommended broiling times when using the Broil mode. Do not use Microwave  for dehydrating items such as flowers, herbs, bread or rolls. Never use modes with Broil for pre-baked products such as bread or bread rolls, or for drying flowers or herbs. Use Convection Bake  for these items and monitor the process carefully.
- ▶ Use caution when using alcohol in your recipes. Alcohol evaporates at high temperatures but may, in rare circumstances, combust on the hot heating elements.
- ▶ Dishes with hollow knobs or handles are not suitable for use with microwave modes. Moisture which has gathered in the hollow recesses can cause pressure to build up and the item can explode.
- ▶ Fire hazard! Using Microwave  or Microwave combination modes with plastic dishes which are not microwave safe can cause them to melt and damage the appliance.
Do not use any containers or cutlery made from or containing metal, aluminum foil, lead, crystal glassware, temperature-sensitive plastics, wooden utensils or cutlery, metal clips or plastic or paper covered wire ties. Do not use plastic containers with the foil lid only partially removed (see "Containers suitable for microwave use").

IMPORTANT SAFETY INSTRUCTIONS

▶ For modes without microwave power: Plastic containers which are not suitable for use in an oven can melt at high temperatures and can even damage the oven or catch fire.

Only use containers which are declared by the manufacturer as being suitable for use in an oven. Follow the manufacturer's instructions on use.



▶ Do not leave the microwave oven unattended when reheating or cooking food in disposable containers made of plastic, paper or other inflammable materials.

Before using single-use containers, make sure they are suitable for use in microwave ovens (See "Containers suitable for microwave use - Plastics").

▶ Do not reheat food in the oven in heat-retaining bags which are intended for use in normal ovens.

These heat-retaining bags usually contain a thin layer of aluminum foil which reflects microwaves. This reflected energy can, in turn, cause the outer paper covering to become hot and ignite.

▶ The Speed Oven can be damaged when using Microwave or Microwave Combination modes if it is empty or incorrectly loaded. For this reason please do not use modes with microwave power to pre-heat cookware or to dry herbs.

Instead use Convection Bake  or Surround  for these procedures.

▶ When using residual heat to keep food in the oven warm, the high humidity and amount of condensation in the Speed Oven can cause corrosion. The control panel, the countertop or the cabinetry can also suffer damage.

Always cover food when using Microwave . Once food is cooked through, use a lower power for continued cooking to reduce the amount of steam produced from the food. When using residual heat do not turn the Speed Oven off. Instead set the temperature to the lowest setting and leave the oven on the selected mode. The fan will then remain on automatically and dissipate the moisture.

IMPORTANT SAFETY INSTRUCTIONS

▶ It is recommended to cover all cooked food that is left in the oven to be kept warm. This will prevent moisture from condensing on the interior of the oven.

▶ A build-up of heat can cause damage to the coating on the floor of the oven.

When using Convection Bake  do not line the floor of the Speed Oven with anything, e.g. aluminum foil or oven liners. Universal trays and glass trays should not be placed directly on the oven floor.

▶ The door can support a maximum weight of 17.5 lbs (8 kg). Do not sit on or lean against an open door, and do not place heavy objects on it. Also make sure that nothing can get trapped between the door and the oven cavity. The oven could get damaged.

▶ When heating food and drinks, remember that the heat is created in the food itself, and that the container will normally be cooler. The dish is only warmed by the heat of the food. The temperature of the container is not an indication of the temperature of the food or liquid in it.

Check the food for the desired temperature after removing it. **This is particularly important when preparing food for babies.** Shake or stir baby milk and food thoroughly after heating, and try it for temperature to ensure that it will not scald the baby.

▶ The Speed Oven is not suitable for cleaning or disinfecting items. Items can get extremely hot and there is a danger of burning when the item is removed from the appliance.

▶ Do not cook or reheat food or liquids in sealed containers, jars or bottles. With baby bottles, the screw top and nipple must be removed.

Otherwise pressure will build up which can cause the bottle or container to explode. Risk of injury.

IMPORTANT SAFETY INSTRUCTIONS

- ▶ The boiling wand ensures that the liquid heats up evenly with bubbles forming at the right time.

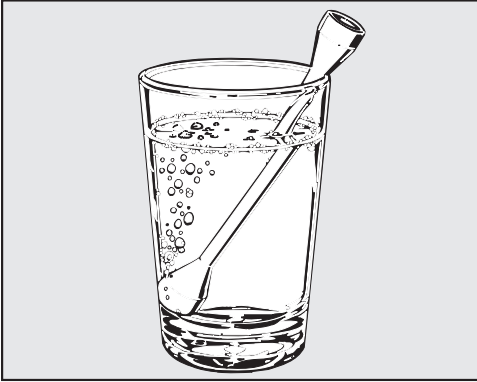

When reheating liquids, always place the boiling wand supplied into the cup or glass. When boiling and in particular when reheating liquids, milk, sauces etc, using microwave power without the boiling wand, the boiling point of the liquid may be reached without the production of typical bubbles. The liquid does not boil evenly throughout. This so-called "superheating" can cause a sudden build up of bubbles when the container is removed from the oven or shaken. This can lead to the liquid boiling over suddenly and explosively. Danger of scalding and burning! The formation of bubbles can be so strong that the pressure forces the oven door open, with a danger of injury and damage. The user could be injured and the appliance damaged.

Ensure you use only the boiling wand supplied with your appliance.

- ▶ Eggs can be cooked without their shells using microwave power only if the yolk membrane has been punctured several times first. The pressure could otherwise cause the egg yolk to explode.

- ▶ Eggs in their shells will explode if cooked with microwave power, even after taking them out of the oven.

They can only be cooked in their shells using microwave heat in a specially designed egg-boiling device available from specialist shops. Hard-boiled eggs must not be reheated in the microwave oven either as they too will explode.

IMPORTANT SAFETY INSTRUCTIONS

- ▶ Food with a thick skin or peel, such as tomatoes, sausage, potatoes and eggplant, should be pierced or cut in several places to allow steam to escape and prevent the food from bursting.
- ▶ To check food temperature, first interrupt the cooking process. Only use a thermometer specifically approved for food use to measure the temperature of the food. Do not use a thermometers containing mercury or liquid as these are not suitable for use with very high temperatures and break very easily
- ▶ Do not use the oven to heat up heating pads filled with grains, gel, etc.
These pads can ignite even after they have been removed from the Speed Oven.
- ▶ This oven must only be used for cooking food. Fumes, vapors or heat given off by glues, plastics or flammable liquids and materials could be hazardous. Do not use it as a dryer, kiln, dehumidifier, etc.
- ▶ Do not cover or block any vent openings.
- ▶ Do not let metal objects (aluminum foil, pans) come in contact with the heating element.
- ▶ Make certain that the power cords of small appliances do not come in contact with or get caught in the oven door.

Cleaning and care

- ▶ Do not use a steam cleaner to clean this oven.
Steam could penetrate electrical components and cause a short circuit.
- ▶ Only clean parts listed in these Operating and Installation Instructions.
- ▶ Scratches on the door glass can cause the glass to break.
Do not use abrasive cleaners, hard sponges, brushes or sharp metal tools to clean the door glass.

IMPORTANT SAFETY INSTRUCTIONS

- ▶ To avoid corrosion on the stainless steel surfaces of the Speed Oven, remove any splashes on the interior walls of the oven from food or liquids containing salt.
- ▶ Do not use oven cleaners. Commercial oven cleaners or oven liners of any kind should not be used in or around any part of the oven.

Accessories

- ▶ Use only genuine original Miele spare parts. If spare parts or accessories from other manufacturers are used, the warranty may become void.
- ▶ Only use the Miele roast probe supplied with this oven. If it is faulty, it must only be replaced with a Miele genuine roast probe.

SAVE THESE INSTRUCTIONS AND REVIEW THEM PERIODICALLY

Guide to the Speed Oven

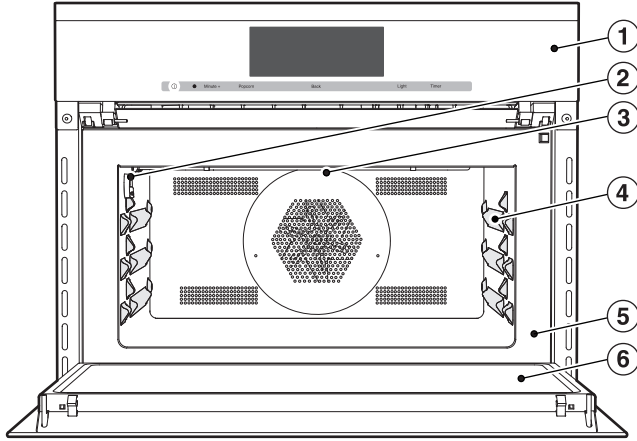

- ① Control panel
- ② Connection socket for the roast probe
- ③ Browning / Broiling element
- ④ 3 Shelf levels for the glass tray and rack
- ⑤ Front frame with data plate
- ⑥ Door

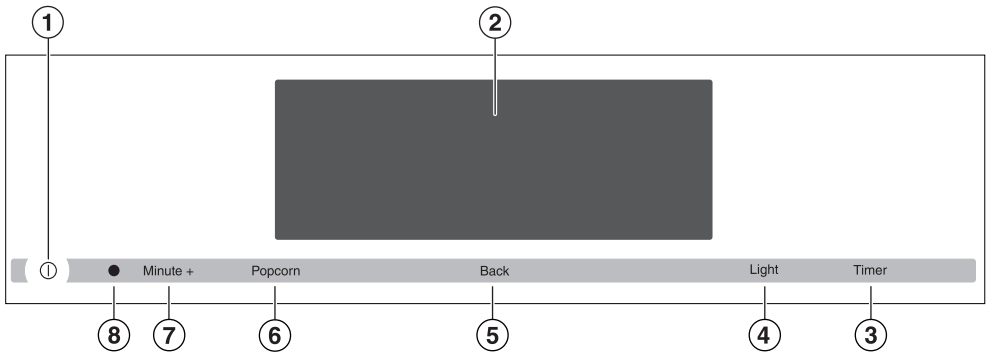

- ① On / Off ① button
Turns the Speed Oven on or off
- ② Display
Displays the time of day and information on the operation
- ③ "Timer" sensor button
To set the timer
- ④ "Light" sensor button
For turning the oven interior lighting on and off
- ⑤ "Back" sensor button
To go back one step at a time
- ⑥ "Popcorn" sensor button
To start the Popcorn function
- ⑦ "Minute +" sensor button
To start the Minute + function
- ⑧ Optical interface
(for service technician use only)

Control panel

Sensor buttons

The sensors react to touch. Each touch is confirmed with an audible tone. This tone can be turned off (see "Settings – Volume - Keypad tone").

Sensor button	Function	Notes
Timer	For activating and deactivating timer / alarm	<p>If a list of options is shown in the display, or if a cooking process is running, you can enter a timer duration (e.g. when boiling eggs on the cooktop) or an alarm time, i.e. a specific time, at any point (see "Alarm + Timer").</p> <p>If the time of day display is turned off, the "Timer" sensor will not react until the oven is turned on.</p>
Light	For turning the oven interior lighting on and off	<p>If a menu appears in the display or if a cooking process is running, touching "Light" will turn the interior light on or off.</p> <p>If the time of day display is turned off, the "Light" sensor will not react until the oven is turned on.</p> <p>The oven interior lighting turns off after 15 seconds during a cooking process or remains constantly turned on, depending on the setting selected.</p>
Back	To go back a step	

Control panel

Sensor button	Function	Notes
Popcorn	Popcorn function	The microwave function starts with power level 6 and a duration of 3 minutes (see "Popcorn"). This function can only be used when no other cooking programs are in use.
Minute +	Minute + function	The microwave function starts with the maximum power level and a duration of 1 minute (see "Minute +"). Touching the sensor repeatedly increases the cooking time. This function can only be used when no other cooking programs are in use.

Control panel

Touch display

The touch screen can be scratched by hard objects, e.g. pens and pencils. Only touch the screen with your fingers.

Touching the display with your finger emits a small electrical charge which in turn triggers an electrical pulse that is detected by the surface of the Touch display.

The Touch display is organized into three areas:

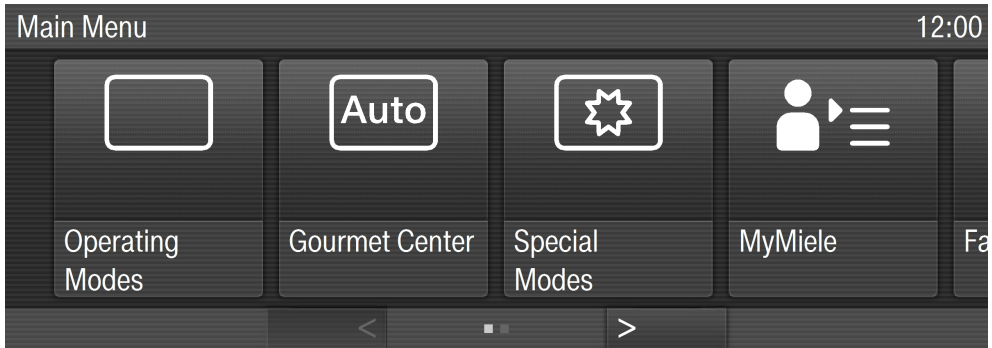







The top line shows what menu level you are currently in. To get to a submenu, tap on the appropriate menu name or "... " in the main menu. The time of day appears on the right.

The middle row shows the current menu and options. You can scroll to the right or left by swiping your finger across the display to the right or left. An item can be selected by tapping it.

In the bottom line you can scroll with the arrows from left to right.

Symbols

The following symbols may appear in the display:

Symbol	Description
	Some settings, e.g. display brightness and buzzer volume, are selected using a bar chart.
	This symbol indicates that there is additional information and advice about using the oven. Select OK to access the information.
	The system lock or sensor lock is active (see "Settings - System Lock  "). The oven cannot be operated.
	Alarm
	Timer
	Core temperature when using the roast probe

Control panel

Basic operation

Each time you touch a possible option the relevant field will light up orange.

To select or open a menu

- Touch the desired field to select it.

Scrolling

You can scroll left or right.

- Swipe the screen, i.e. place your finger on the Touch display and move it in the desired direction.
- Or: Using your finger you can tap the arrows < and > to scroll left or right.

Exiting a menu

- Select "Back".

Entering numbers

You can enter numbers by scrolling through and touching the roller, or by using the numerical keypad.

To enter numbers using the roller:

- Swipe the roller up or down to select the desired number.

To enter numbers using the numerical keypad:

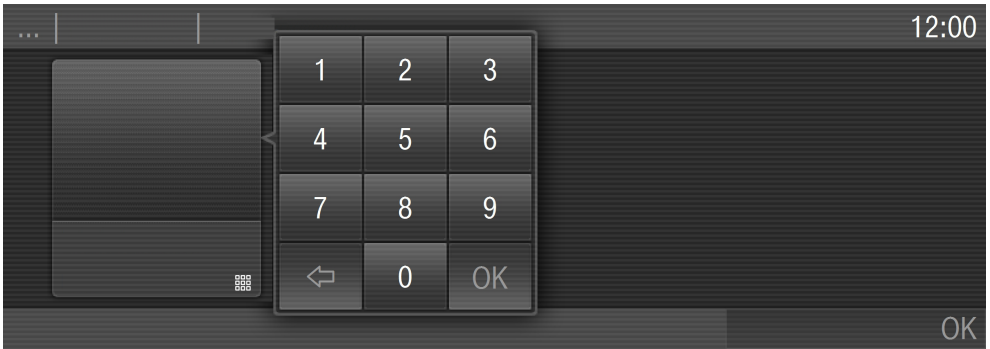

- Touch  in the bottom right of the input field.

The numerical keypad appears.

- Touch the required numbers.

Once you have entered a valid value, the OK sensor will light up green. The last figure entered can be deleted by using the arrow.

- Touch "OK".

Entering letters

Enter a name using a keyboard. Try to use short, concise names.

- Select the required letters or characters.
- Touch Save.

Features

Model numbers

A list of the ovens described in these operating instructions can be found on the back page.

Data plate

The data plate located on the front frame of the oven is visible when the door is open.

Printed on the data plate are the model number, serial number and the connection data (voltage/frequency/maximum rated load) of the oven.

Have this information available when contacting Miele Technical Service.

Items included

The oven is supplied with:

- the operating and installation instructions for using the Speed Oven,
- screws for securing your appliance into the cabinetry, and
- various accessories.

Standard and optional accessories

This Speed Oven is supplied with a glass tray and rack.

All accessories and cleaning and care products in these instructions are designed to be used with Miele ovens.

They can be ordered from the Mieleusa.com website or Miele.

When ordering, please have ready the model number of your oven and of the desired accessories.

Glass Tray

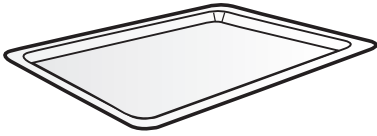

The glass tray is suitable for use with all operating modes.

Always use the glass tray when using Microwave (Solo) .

Do not place items weighing more than 17.5 kg (8 kg) on it.

Do not place the hot glass tray on a cold surface, such as a tiled or granite countertop. The glass tray could get damaged. Use a suitable heat-resistant mat or pot rest.

Wire rack with non-tip safety notches

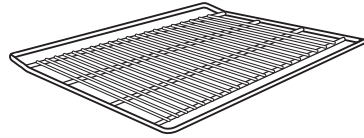

The rack is designed to be compatible with microwaves and so can be used with Combi modes which use microwave power. However it is not suitable for use with the Microwave (Solo)  mode.

Danger of burns! The rack gets hot when used with Combi modes which use the microwave function. Use pot holders when placing food in a hot oven and when taking it out.

Do not place the rack directly on the floor of the oven and do not use it with Microwave (Solo) . This could cause arcing which could damage the oven.

Do not place items weighing more than 17.5 lbs (8 kg) on the rack.

The rack has non-tip safety notches which prevent it being pulled completely out when it only needs to be pulled out partially.

When pushing the rack back in, always ensure that the safety notches are at the **back** of the oven.

Features

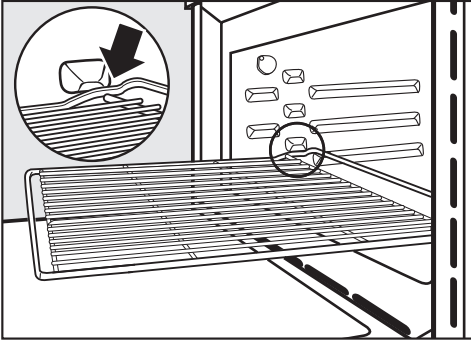

Boiling wand



The boiling wand helps liquids heat evenly.

- When reheating liquids, place the boiling wand into the cup or glass.

- To remove the rack, lift it upwards slightly at the front when the safety notches connect with the sides of the oven.

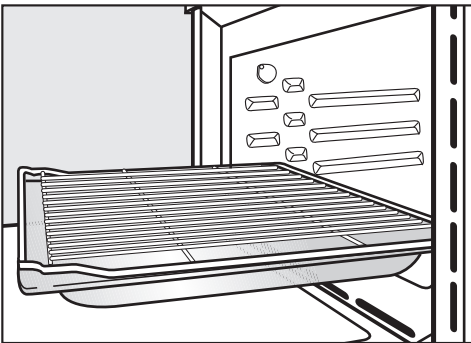

- We recommend using the rack together with the glass tray when cooking items on the rack which might drip.

Roast Probe

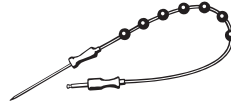

Using the roast probe enables you to accurately monitor the temperature during the cooking process (see "Roasting - Roast probe").

Round Baking Form HBF27-1

Microwave modes will damage the Round Baking Form.

Do not use the round baking form when using Microwave (Solo)  or Combi modes.

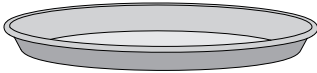

This circular form is suitable for cooking fresh or frozen pizzas, flat cakes, tarts and baked goods.

Place the round baking form on the rack.

The surface has been treated with PerfectClean enamel.

Miele Oven Cleaner

Miele oven cleaner is suitable for removing stubborn soiling. It is not necessary to preheat the oven before use.

Features

Speed Oven controls

The oven controls enable you to use the various cooking modes to bake, roast, broil and reheat.

It also allows you to access:

- the time of day display,
- a timer,
- a timer to automatically turn cooking programs on and off,
- the MasterChef programs,
- the creation of a Favorite program,
- settings that can be customized.

Safety features

System lock

The system lock prevents the oven from being used unintentionally (see "Settings - System lock").

The system lock will remain activated even after a power failure.

Safety cut-out

A mode **without Microwave** can be started without specifying a cooking time. To prevent continuous use and avoid the risk of fire, the Speed Oven will turn itself off automatically after a time between 1 hour and 12 hours depending on the function and temperature chosen.

If a **Combi mode** is followed in quick succession by another mode using microwave power, the magnetron (which produces the microwaves) cannot be turned on again until approx. 10 seconds have elapsed. Therefore wait a short time before starting the second process.

Cooling fan

The cooling fan comes on automatically when a cooking program is started. The cooling fan mixes hot air from the oven cavity with cool room air before venting it out into the kitchen through vents located between the appliance door and the control panel.

The cooling fan will continue to run for a while after a cooking process to prevent moisture building up in the oven, on the control panel or on the surrounding cabinetry. It will turn itself off automatically after a while.

PerfectClean treated surfaces

The revolutionary PerfectClean enamel is a smooth, non-stick surface that cleans easily with a sponge.

Food and soiling from baking and roasting can be easily removed from these surfaces.

Do not use ceramic knives as these will scratch the PerfectClean surface.

Follow the instructions in the "Cleaning and Care" section of this manual so the anti-stick and easy cleaning properties are retained.

The oven compartment and the rack have a PerfectClean finish.

Before using for the first time

General settings

 The oven must not be operated until it has been properly installed within cabinetry.

The oven will turn on automatically when it is connected to the power supply.

Welcome screen

A welcome greeting is displayed. You will then be asked to select some basic settings which are needed before the appliance can be used.

- Follow the instructions on the display.

Setting the language

- Select the desired language.
- Confirm with OK.

Setting the country

- Select the desired country.
- Confirm with OK.

Setting the voltage (electrical version)

 The voltage set must match that of the house as to not damage the oven.

Confirm the voltage before setting. In doubt contact a qualified technician.

- Select the voltage.
- Confirm with OK.

Setting the date

You can enter numbers by scrolling through and touching the roller, or by using the numerical keypad.

- Set the day, month and year.
- Confirm with OK.

Before using for the first time

Set the time of day

You can enter numbers by scrolling through and touching the roller, or by using the numerical keypad.

- Set the time of day in hours and minutes.
- Confirm with OK.

The time of day can be displayed in 12 hour format (see "Settings - Time of day - Clock format").

Time of day display

You will then be asked when you want the time of day to show in the display when the oven is turned off (see "Settings - Time of day - Display"):

- On

The time is always visible in the display.

- Off

The display appears dark to save energy. Some modes are limited.

- Night Dimming

The time only shows in the display between 5:00 am and 11:00 pm. It turns off at night to save energy.

- Select the desired option.
- Confirm with OK.

Information regarding energy consumption will appear in the display.

- Confirm with OK.
- Follow further instructions in the display.

Set-up Successfully Completed is displayed.

- Confirm with OK.

The oven is now ready to use.

If you accidentally select the wrong language, follow the instructions described in "Settings - Language ".

Before using for the first time

Heating the oven

New ovens may have a slight odor during their first use. Heating up the oven for at least one hour with nothing in it will eliminate the odor.

Ensure that the kitchen is well ventilated while the appliance is being heated up for the first time. Close doors to other rooms to prevent the smell spreading throughout the house.

- Remove any protective wrapping and sticky labels from the oven.
- Take all accessories out of the oven and clean them (see "Cleaning and care").
- Before heating the oven up, wipe the interior with a damp cloth to remove any dust or bits of packaging that may have accumulated in the oven cavity during storage and unpacking.
- Turn on the oven.

The main menu will appear.

- Select Operating Modes .
- Select Convection Bake .

The recommended temperature is displayed 320 °F (160°C).

The oven heating, lighting and cooling fan will turn on. The oven heating, lighting and cooling fan will turn on. The oven heating, lighting and cooling fan will turn on.

- Set the maximum possible temperature 485°F (250°C).
- Confirm with OK.

Heat up the oven for at least one hour.

After at least one hour:

- Turn the oven off.

After heating up for the first time

 Danger of burns! Allow the oven to cool before cleaning.

- Turn on the oven.
- Select  to turn on the oven light.
- Clean the oven interior with warm water and liquid dish soap, applied with a soft sponge or microfiber cloth.
- Dry all surfaces with a soft cloth.
- Turn the lighting and the oven off.

Leave the oven door open until the oven interior is completely dry.

Accessing the "Settings" menu

From the main menu:

- Select  Settings.

They can be checked and changed, if needed.

Settings cannot be altered while a cooking program is in progress.

Changing and saving settings

- Select  Settings.
- Swipe across the screen until the desired setting appears, then touch it to select.



The settings which are currently selected will have a colored frame around them.

- Swipe across the screen until the desired option appears, then touch it to select it.
- Confirm with OK.

The setting is now saved.

Settings

Settings overview

Option	Available settings
Language 	... / deutsch / english / ... Country
Time	Display On / Off * / Night Dimming Clock Type Analog * / Digital Clock Format 24 h / 12 h (am/pm) * Set
Date	
Lighting	On / On for 15 seconds *
Start Screen	Main Menu Operating Modes Gourmet Center Special Modes MyMiele Favorites
Brightness	
Volume	Buzzer tones Keypad tone Welcome Melody
Units of Measurement	Weight g / lb/oz * Temperature °C / °F *
Quick Microwave	Power Level Duration
Popcorn	Duration
Keeping Warm	On Off *

* Factory default

Option	Available settings
Cooling Fan	Temperature Controlled * Time Controlled
Default temperatures	
Safety	System Lock On / Off * Sensor Lock On / Off *
Calibrate Temperature	■■■■■□□□□
Electrical Version	208V / 60Hz 220V / 60Hz 240V / 60Hz
Showroom Program	Demo Mode On / Off *
Factory default	Settings Favorites MW Power Levels Default Temperatures MyMiele

* Factory default

Settings

Language

The desired country and language can be set.

After selecting and confirming your choice, the language selected will appear in the display.

Tip:: If you accidentally select a language you do not understand, select the  symbol to return to the submenu.

Time of day

Display

Select how you would like the time of day to appear in the display when the oven is turned off:

– On

The time of day will always appears in the display. To turn the Light on and off or use the Alarm + Timer, Minute + or Popcorn functions touch the relevant sensor.

– Off

The display is turned off to save energy. The oven has to be turned on before you can use it. This also applies when using the Alarm + Timer, Light, Minute + and Popcorn.

– Night Dimming

To save energy, the time is only visible in the display between 5:00 am and 11:00 om. The rest of the time it is not visible.

Clock Type

You can choose from an analogue clock face or a digital (h:min) display.

The date will also appear in the digital clock display.

Clock Format

You can select the clock format for the time of day:

– 24 h

The time of day is shown in a 24 hour clock format.

– 12 h (am/pm)

The time of day is shown in a 12 hour clock format.

Set

Set the hours and the minutes.

If there is a power failure, the current time of day will reappear once the power has been restored. The time is stored in memory for about 200 hours.

Synchronize

This menu item only appears if you are connected to the Miele@Home system (see separate instructions).

Date

Set the date.

When the oven is turned off, the date only appears if the oven is set to "Time – Clock Type – Digital".

Lighting

- On

The interior lighting is turned on during the entire cooking period.

- On for 15 seconds

The oven lighting turns off 15 seconds after a program starts. Touching "Light" turns it on for another 15 seconds.

Start screen

The main menu will appear in the display when the oven is turned on. You can change this default setting so that, for instance, the oven modes or MyMiele settings appear in the display.

Brightness

The display brightness is represented by a bar with seven segments.



- Select **Darker** or **Lighter**, to change the brightness of the display.

Settings

Volume

Buzzer tones

The volume is represented by a bar with seven segments.



Maximum volume is selected when all segments are filled. If none of the segments are filled, the volume is turned off.

- Select **Quieter** or **Louder**, to adjust the volume.
- Select **On** or **Off** to turn the buzzer tones on or off.

Keypad tone

The volume is represented by a bar with seven segments.



Maximum volume is selected when all segments are filled. If none of the segments are filled, the volume is turned off.

- Select **Quieter** or **Louder**, to adjust the volume.
- Select **On** or **Off**, to turn the keypad tone on or off.

Welcome melody

You can turn the welcome melody on or off. It sounds when the **On / Off** button  is touched.

Units of measurement

Weight

– g

The weight of food in MasterChef programs is shown in grams.

– lb/oz

The weight of food in MasterChef programs is shown in pounds and ounces.

Temperature

– °C

The temperature is displayed in Celsius.

– °F

The temperature is displayed in Fahrenheit.

Minute +

The pre-set power level is 7 (maximum) and the maximum duration is 1 minute. The power level is represented by a bar with seven segments.



The maximum power level is selected when all segments are filled.

- Power Level

Power levels 1 to 7 can be selected.

- Duration

The maximum duration that can be set depends on the power level selected:

Level 1 to 3: maximum 10 minutes

Level 4 to 7: maximum 5 minutes

- Select Lower or Higher, to adjust the power level.

Popcorn

The power level is preset to level 6 and the duration at 3 minutes. This is suitable for most brands of microwave popcorn.

The cooking time can be changed but not the microwave power level.

- Duration

The maximum duration that can be set is 4 minutes.

Keeping Warm

- On

The keeping warm function is activated as standard with Microwave (Solo)  if a power level of 4 or higher and a cooking duration of min. 10 minutes is selected.

If food is not removed from the oven at the end of a program, the keeping warm function will automatically start after approx. 5 minutes. Keeping Warm will appear in the display and the food will be kept warm for approx. 15 minutes using power level 2. The keeping warm phase is canceled if the door is opened during this time.

- Off

The keeping warm function is deactivated.

Settings

Cooling fan

The cooling fan will continue to run for some time after the oven has been turned off to prevent humidity from building up in the oven, on the control panel or in the surrounding cabinetry.

- Temperature Controlled

The cooling fan turns off when the temperature in the oven drops below 160°F (70°C).

- Time Controlled

The cooling fan will turn off after approx. 25 minutes.

Condensation can cause the cabinetry and the countertop to be damaged. This could lead to corrosion of the appliance.

When keeping food warm in the oven, increases to the Time Controlled setting can lead to condensation of the control panel, moisture on the countertop and on the cabinetry.

Do not adjust the Time Controlled setting and try not to leave food in the warm oven.

Default temperatures

If you often cook with temperatures that differ from the default, it makes sense to change the default temperatures.

After selecting this option, a list of oven modes will appear in the display.

- Select the desired mode.

The default temperature is displayed along with the available temperature range.

- Change the default temperature.

- Confirm with OK.

Microwave power levels

If you cook with different power levels a lot, it makes sense to change the recommended microwave power levels.

The recommended power levels can be changed for Microwave (Solo)  and for Microwave Combi modes.

After selecting this option a list of oven modes will appear in the display together with their recommended power levels.

- Microwave (Solo) 
Power levels 1 to 7 (represented by a bar with seven segments)
- Microwave Combi modes:
Power levels 1 to 3 (represented by a roller)
- Select the desired mode.
- Change the recommended power level if necessary.
- Confirm with OK.

Safety

System lock

The system lock prevents the oven being turned on inadvertently.

The system lock will remain activated even after a power failure.

Select **On** to activate the system lock.

The timer can still be used when the system lock is active.

- **On**
The system lock is now active. If you want to use the oven, touch  for at least 6 seconds.
- **Off**
The system lock is not active. The oven can be used as normal.

Settings

Sensor lock

The sensor button lock prevents you from accidentally turning the oven off or changing a cooking program.

– On

Before you can use a mode, touch  for at least 6 seconds.

– Off

The buttons respond immediately to a finger touch.

Calibrate temperature

Using temperature calibration the temperature can be modified, in all modes and MasterChef programs, so that it is slightly higher or lower than shown.

The temperature calibration is represented by a bar with seven segments.



If all of the segments are filled the oven temperature is much higher than indicated in the display. If no segment is filled the oven temperature is much lower than indicated.

- Select + or –, to adjust the temperature calibration.
- Confirm with OK.

Electrical Version

Setting the voltage (electrical version)

- Select the desired voltage and corresponding frequency.
- Confirm with OK.

Showroom Program

This mode enables the oven to be demonstrated in showrooms without heating up. It should not be set for domestic use.

Demo Mode

If you have demo mode activated
Demo Mode is active. The appliance will not heat up **will appear when you turn on the oven.**

- On
Touch OK for at least 4 seconds to activate demo mode.
- Off
Touch for at least 4 seconds to deactivate demo mode. The oven can then be used as normal.

Factory default

- Settings
Any settings that have been altered will be reset to the factory default setting.
- Favorites
All Favorites will be deleted.
- MW Power Levels
Power levels which have been changed will be reset to the factory default settings.
- Default temperatures
Any default temperatures that have been changed will reset to the factory default settings.
- MyMiele
All MyMiele entries will be deleted.

MyMiele

You can personalize your oven using the MyMiele  function by inputting frequently used processes.

It is particularly useful with MasterChef program as you do not need to work through every screen in order to start your program.



You can also set processes that you have entered into MyMiele to appear in the Start screen (see "Settings – Start screen").

To add an entry

You can add up to 20 entries.

- Select MyMiele.
- Select Add entry.

You can select options listed in the following categories:

- Operating Modes
- Gourmet Center Auto
- Special Modes 
- Favorites 

- Confirm with OK.

The selected option with its symbol will appear in the list.

- Proceed as above for further entries as required. You can only chose options that have not already been selected.

Editing MyMiele

After selecting Edit you can

- add entries as long as MyMiele contains fewer than 20 entries,
- delete entries,
- sort entries as long as MyMiele contains more than 4 entries.

Deleting entries

- Select MyMiele.
- Select Edit.
- Select Delete entry.
- Select the entry that you want to delete.
- Confirm with OK.

The entry will then be removed from the list.

Sorting entries

The order can be rearranged as long as there are more than 4 entries.

- Select MyMiele.
- Select Edit.
- Select Sort entry.
- Select the position you want to move it to.
- Confirm with OK.

The entry will now appear in the position selected.

Alarm + Timer

Using "Timer", you can set an alarm for a specific time or set the timer duration to time an activity in the kitchen e.g. boiling eggs.

Two alarms can be set simultaneously, two timer durations or an alarm and a kitchen timer duration.

Using the Alarm

The alarm can be used to set a specific time at which the oven buzzer will sound.

Setting the alarm

If the setting Time - Display - Off is selected, you will need to turn the oven off before setting the alarm. The alarm time will then appear in the display when the oven is turned off.

- Select "Timer".
- Select New Alarm.
- Set the time for the alarm.
- Confirm with OK.

When the oven is switched off, the alarm time and  will appear instead of the time of day.

If you are cooking at the same time or if you are in a different menu, the alarm time and  will appear in the top right-hand corner of the display.

At the set alarm time

- the Alarm symbol  will flash next to the time in the display.
- a buzzer will sound if turned on (see "Settings - Volume - Buzzer tones").
- Select "Timer" or the alarm in the upper right of the display.

The buzzer will turn off and the symbols in the display will go out.

Changing an alarm

- Select the alarm in the upper right of the display or select "Timer" and the desired alarm.

The alarm selected appears.

- Set the new time for the alarm.
- Confirm with OK.

The adjusted alarm time is now saved and will appear in the display.

Deleting an alarm

- Select the alarm in the upper right of the display or select "Timer" and the desired alarm.

The alarm selected appears.

- Select Reset.

The alarm will be deleted.

Using the Timer

The timer can be used to time any activity in the kitchen , e.g. boiling eggs.

The timer can also be used at the same time as a cooking program if a start and finish time have been set, e.g. a reminder to stir the dish or add seasoning.

A maximum time of 9 hours and 59 minutes can be set for the timer.

Setting the timer

When the setting Time - Display - Off is set the oven must be turned on to set the timer. The timer can then be seen counting down in the display when the oven is turned off.

Boiling eggs and setting the timer for 6 minutes and 20 seconds

- Select "Timer".
- Select New Timer Time.
- Set the timer for the required time.
- Confirm with OK.

When the oven is turned off, the timer duration counts down in the display and  appears instead of the time of day.

If you are cooking at the same time or if you are in a different menu, the timer duration and  will appear in the top right-hand corner of the display.

Alarm + Timer

At the end of the timer

- the Timer symbol  flashes,
 - the time starts counting upwards,
 - A buzzer will sound if turned on (see "Settings - Volume - Buzzer tones").
- Select "Timer" or the timer in the upper right of the display.

The buzzer will turn off and the symbols in the display will go out.

Resetting the timer

- Select the timer in the upper right of the display, or select "Timer" and the desired timer.

The time previously set appears.

- Set a new timer duration.
- Confirm with OK.

The changed time is saved and will count down in seconds.

Canceling the timer

- Select the timer in the upper right of the display, or select "Timer" and the desired timer.







The time previously set appears.

- Select `Reset`.





The timer has been canceled.

The oven has a wide range of modes for preparing a variety of foods.

Solo Modes

Oven modes	Default temperature	Temperature range
Convection Bake  Use this mode for baking and roasting on several levels at the same time. You can cook at lower temperatures than with the Surround  mode because the fan distributes the heat evenly throughout the cavity for a consistent baking temperature.	325°F (160°C)	75-475°F (25-275°C)
Auto Roast  For a premium result, the meat is seared at a high temperature keeping meat tender and juicy.	320°F (160°C)	200-450°F (100-230°C)
Maxi Broil  For broiling meats e.g. steak, chops, kebabs, etc. The entire Browning / Broiling element will glow red to produce the required heat.	Level 3	Level 1-3
Convection Broil  This mode distributes hot air from the Browning/ Broiling element over the food using the fan. This allows for a lower temperature to be used then when using Broil  . Ideal for broiling thicker cuts of meat (e.g. chicken, roulades).	375°F (200°C)	200-500°F (100-250°C)
Intensive  This mode gently circulates heated air from the lower heating element using the fan to create a brick oven environment. Ideal for baking pizza, focaccia, pies and tarts that require a crisp base and moist toppings.	350°F (170°C)	125-475°F (50-250°C)

Guide to the modes



Oven modes	Default temperature	Temperature range
Surround  This premium baking mode uses heat from the upper and lower elements to create perfect results on all baking recipes.	350°F (180°C)	75–525°F (25–275°C)
Bake  This mode uses traditional baking techniques to perfect pies and biscuits.	375°F (190°C)	125–450°F (50–225°C)
Gentle Bake  A combination of different heating elements ensures excellent baked good, gratins and lasagna.	375°F (190°C)	200–475°F (100–250°C)
Convection Roast  This mode uses the convection fan to circulate heated air throughout the oven. Ideal for cooking delicate cuts of meat, fish and crispy poultry.	320°F (160°C)	30–475°F (250°C)
Surround Roast  For roasting traditional recipes, e.g. pot roast, and braising or cooking at low temperatures.	355°F (180°C)	30–475°F (250°C)

Microwave (Solo)



Oven modes	Default power level	Power level range
Microwave  This mode is used to rapidly defrost, reheat and cook food.	7	1-7

Combination Modes

During Combination modes the heating element and the magnetron turn on and off alternating one after the other. The heating element browns the food and the magnetron helps it cook quickly. The maximum power level is 3.

Oven modes	Default temperature	Temperature range
Combi Bake  For rapid heating and cooking of food, while browning at the same time. Microwaves will speed up your cooking process without sacrificing the quality of food. When baking do not set the microwave power level higher than 2.	320°F (160°C)	85-425°F (30-220°C)
Combi Auto Roast  For roasting at high temperatures and slow cooking at low temperatures. The Microwaves will speed up your cooking process without sacrificing the quality of food. During the searing phase the oven heats up to 450°F (230°C) to seal the meat. Once this temperature has been reached, the oven temperature automatically drops back down to the pre-set cooking temperature for continued roasting. The maximum adjustable microwave power level is 3.	320°F (160°C)	212-395°F (100-200°C)

Guide to the modes

Oven modes	Default temperature	Temperature range
<p>Micro Broil </p> <p>For broiling meats e.g. steak, chops, kebabs, etc. The entire Browning / Broiling element will glow red to produce the required heat.</p> <p>The maximum adjustable microwave power level is 3.</p>	Broil level 3	Broil level 1-3
<p>Combi Broil </p> <p>This mode distributes hot air from the Browning / Broiling element over the food using the fan. This allows for a lower temperature to be used then when using Micro Broil . Ideal for broiling thicker cuts of meat (e.g. chicken).</p> <p>The maximum adjustable microwave power level is 3.</p>	395°F (200°C)	210-395°C (100-200°C)

How it works

The Speed Oven contains a high-frequency tube called a magnetron. It converts electrical energy into microwaves. The microwaves are then distributed evenly throughout the metal sides of the oven interior to reach the food from all sides.

In order for microwaves to reach the food, they must be able to penetrate the cooking container being used. Microwaves can penetrate porcelain, glass, cardboard and plastics, but not metal. Do not, therefore, use dishes made of metal, or which contain metal, for example in the form of gold or silver trim. The metal reflects the microwaves and this could cause sparking. The microwaves cannot be absorbed.

Microwaves pass through a suitable container and find their way directly into the food. All food contains moisture molecules which, when subjected to microwave energy, start to oscillate 2.5 billion times a second. The friction caused by this vibration creates heat, which first starts developing around the outside of the food and then slowly penetrates towards the center. The moisture, fat and sugar content of food will affect the speed at which it is cooked.

Advantages

- Food can generally be cooked with little liquid or oil.
- Defrosting, heating and cooking is faster than using a conventional oven.
- Nutrients, such as vitamins and minerals, are generally retained.
- The color, texture and taste of food are not impaired.

Microwaves stop being produced when the program is interrupted or the door is open. While in operation the closed, sealed door prevents microwaves from escaping the appliance.

Microwave power levels

Microwave power levels 1 to 7 can be selected.

Selecting cookware

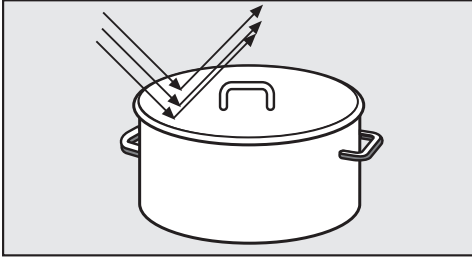

Microwaves are reflected by metal.

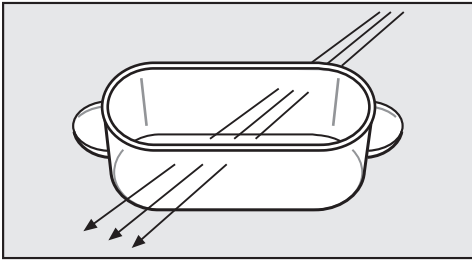

They pass through glass, porcelain, plastic and cardboard.

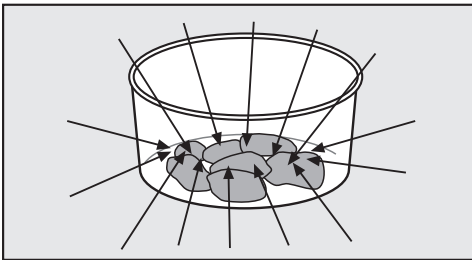

They are absorbed by food.

Non-microwave safe dishes can suffer damage or cause damage to the oven when using the Microwave (Solo)  and Combination modes with Microwave. Risk of Fire!

The material and shape of containers used affect cooking results and times. Circular and oval containers work best. The food will heat more evenly than in a square container.

Containers suitable for microwave use

Glassware

Heat-resistant glass or ceramic glass are ideal for use with microwave power.

Exception: Do not use crystal glass as it contains lead which can crack or shatter in a microwave.

Porcelain

Porcelain is a suitable material.

Exception: Do not use porcelain with gold or silver edging or items with hollow knobs or handles, as insufficient ventilation may cause a build-up of pressure.

Earthenware

Decorated earthenware is only suitable if the decoration is beneath an all-over glaze.

Danger of burning! Wear pot holders when removing earthenware dishes from the Speed Oven.

Selecting cookware

Plastics

Plastic containers and plastic disposable containers may only be used with Microwave (Solo)  if they have been declared as suitable for microwave use by the manufacturer. To protect the environment, it is best to avoid using single-use containers.

Do not leave the Speed Oven unattended when reheating or cooking food in disposable containers made of plastic, paper or other flammable materials.

Plastic cookware must be heat-resistance up to at least 230°F (110°C). Otherwise the cookware will deform and the possibly come in contact with the food.
Only use plastic dishes in the Microwave  and combination modes.

– Plastic microwave containers

Readily available from retail stores.

– Styrofoam containers

Disposable containers, such as trays made from styrofoam, can only be used for very short, timed warming and reheating of food.

– Plastic cooking bags

Plastic cooking bags can be used for cooking and reheating food.

They should be pierced beforehand so that steam can escape. This prevents a build-up of steam and reduces the risk of the bag bursting.

There are also cooking bags that do not need to be pierced. Following the instructions listed on the packaging.

– Roasting bags

Follow the manufacturer's instructions.

 Fire hazard!

Do not use metal clips, plastic clips containing metal parts, or paper ties containing wire. There is a danger that they will ignite when heated.

– Melamine

Plastic tableware made from melamine is not suitable for use in this oven.

Melamine absorbs microwave energy and becomes very hot. Before purchasing plasticware be sure that it is microwave-safe.

Selecting cookware

Unsuitable containers for microwave use

 Dishes with hollow knobs or handles are not suitable for use with microwave modes. Moisture which has gathered in the hollow recesses can cause pressure to build up and the item can explode.

Metal

Metal reflects microwaves and obstructs the cooking process.

Do not use metal containers, aluminum, foil, metal cutlery and china with metallic decoration such as gold rims or cobalt blue with Microwave combination modes.

Do not use containers where the foil lid has not been completely removed as small pieces of foil can cause sparking.

Exceptions:

The rack **supplied** with the Speed Oven is suitable for cooking with Microwave and Combination modes. Do not place the rack on the floor of the oven.

- Metal bakeware can be used with Microwave combination modes.
- Ready-meals in aluminum foil trays can be defrosted and reheated using microwave power as long as the lid is removed.

When using foil trays there is a risk of arcing or sparks occurring in the oven. For this reason, place the foil tray on the glass tray and not on the rack.

The foil tray must be at least 3/4" (2 cm) away from the oven walls. It must not touch them.

However, as food is only heated from the top, it is better to remove the food from the aluminum foil container and transfer it to a dish suitable for use in a microwave oven. The heat distribution will be more even.

– Aluminum foil pieces

For even defrosting and to avoid overcooking unevenly shaped cuts of meat, poultry or fish, small pieces of aluminum foil may be used to mask thin pieces for the last few minutes of the program.

Make sure that the aluminum foil is at least 3/4" (2 cm) from the oven walls at all times. It must not touch the walls.

– Metal meat skewers or clamps

These should only be used if they are very small in comparison to the size of the cut of meat.

Glazes and colors

Some glazes and colors contain metal and are therefore unsuitable for microwave modes.

Wood

Wooden dishes are not suitable. Moisture contained in the wood evaporates when exposed to microwave energy, causing the wood to dry and crack.

Testing dishes for their suitability

If in doubt as to whether glass, earthenware or porcelain plates or dishes are suitable for use with microwave energy, a simple test can be performed:

- Insert the glass tray on shelf level 1 and place the empty item you wish to test on the glass tray. Fill a suitable glass with water and also place this on the glass tray.
- Close the door.
- Select Microwave .
- Set the highest microwave power level (7) and a cooking duration of 30 seconds.
- Confirm with OK and start the program.

If a cracking noise is heard accompanied by sparks during the test, turn the appliance off immediately. Any cookware which causes this reaction is unsuitable for use with microwave power. If in doubt, contact the cookware manufacturer.

This test cannot be used to check whether items with hollow knobs or handles are suitable for use with microwave power.

Selecting cookware

Placing the dish in the Speed Oven

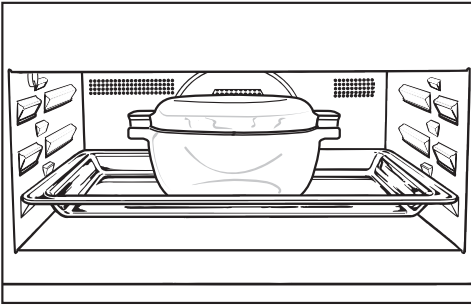

- Insert the glass tray on shelf level 1.
- The dish containing the food should always be placed in the middle of the glass tray.

Placing the food directly on the floor of the oven would give unsatisfactory and uneven results as the microwaves would not be able to reach the food from below.

Lid

The lid offers the following advantages:

- Prevents too much steam escaping, especially when cooking foods which need longer to cook, such as potatoes.
- Speeds up the cooking process.
- Prevents food from drying out.
- Helps keep the oven interior clean.

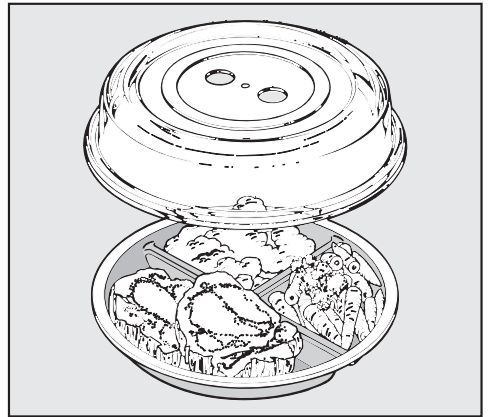



- When using Microwave (Solo) , always cover the food with a lid or cover made of microwave safe glass or plastic.

These covers are available at retail stores.

Alternatively, use plastic wrap recommended for use in a microwave oven (pierce as instructed by the manufacturer). Heat can cause normal plastic wrap to distort and fuse with the food.

Selecting cookware

 The cover can only withstand temperatures up to 230°F (110°C). Higher temperatures (e.g. those used for Broil and Convection Bake) can cause the plastic to distort and fuse with the food. The cover should only be used with Microwave (Solo) .

The cover should not form a seal with the container. If the cover is used with a container which only has a narrow diameter, there might not be enough room for condensation to escape through the holes in the top. The cover could get too hot and could start to melt.

■ **Do not** use the cover if:

- cooking breaded food,
- cooking food which requires a crisp finish,
- cooking food with a Combi mode.

 Otherwise pressure can build up, causing the container to explode, posing a severe risk of injury. Do not cook or reheat food or liquids in sealed containers, jars or bottles. Otherwise pressure will build up which can cause the bottle or container to explode. Risk of injury.

Energy saving tips

- Remove any accessories from the oven that you do not require for cooking.
- If possible, do not open the door during a program. If the door is opened during a program that is not using microwave power, the heat in the oven automatically turns off. The fans continue to run. As soon as the door is closed again, the program will continue.
- If a temperature range is given, it is best to select the lower temperature and check the food after the shortest cooking time given.
- Convection Broil  can be used for a wide variety of foods. Lower temperatures can be used than with other Broil modes which use the maximum temperature setting.
- The default setting for the Time of Day display Time - Display - Off will consume the least amount of energy.
- With the factory default setting Lighting - On for 15 seconds the oven interior lighting turns off automatically after 15 seconds. It can be turned on again at any time by touching "Light".
- When cooking with automatic shut-off or the wireless roast probe, the oven heating will turn off automatically shortly before the end of cooking. The residual heat is sufficient to finish the cooking process. Energy Save will appear in the display. The cooling fan or hot air fan (depending on mode used) will remain on.
- The oven turns off automatically if a button is not pressed to save power. The amount of time before the oven turns off depends on the selected settings, e.g. mode, temperature, cooking duration, etc.

Quick Guide

- Turn on the oven.

The main menu will appear.

- Place the food in the oven.
- Select Operating Modes.
- Select the desired mode.

The oven mode and default temperature will appear.

The oven heating, lighting and cooling fan will turn on.

- Adjust the default temperature if necessary.

The default temperature will be automatically accepted within a few seconds. If necessary, select **Change** to go back to the temperature setting (see "Additional functions - Changing the temperature").

- Confirm with OK.

The required and the actual temperatures will appear.

You will see the temperature rising in the display. A buzzer will sound when the oven temperature is reached if this option is selected (see "Settings - Volume - Buzzer tone").

After the cooking process:

- Take the food out of the oven.
- Turn the oven off.

Cooling fan

After the cooking process the cooling fan will continue to run for a while after a program is complete to prevent moisture from building up in the oven, on the control panel or surrounding cabinetry.

When the temperature in the oven has fallen sufficiently the cooling fan will turn off automatically.

The default setting can be changed if desired (see "Settings - Cooling Fan").

Solo modes



Additional functions

You have placed the food in the oven, selected a mode and set the temperature.

By selecting Additional Settings you can adjust cooking times and adjust additional settings.

- Select Change.
- Select Additional Settings.

Additional options will appear in the display for you to select for change if desired.

- Duration
- Core temperature (This will only appear if you are using the roast probe. You cannot set a cooking duration when using the roast probe.)
- Ready at
- Start at (This will appear if a Duration or Ready at time has been set.)
- Rapid PreHeat (This only appears if a temperature of more than 210°F (100°C) has been set for Convection Bake , Auto Roast  or Surround .)
- Crisp function (This moisture reduction feature will allow surfaces to crisp on the outside.)
- Change Operating Mode (You can change the oven mode during operation.)

Changing the temperature

As soon as a cooking mode is selected, a default temperature will appear in the display together with its possible range (see "Guide to the modes").

- If the default temperature is suitable for your recipe, confirm it with "OK".
- If it is not suitable for your recipe, you can change it for this particular cooking program.

You can also permanently reset the default temperature to suit your personal cooking habits (See "Settings - Default temperatures").

Example: You have selected Convection Bake  and 350°F (170°C) and can see the temperature increasing.



You want to reduce the target temperature to 310°F (155°C).

- Select Change.
- Changing the temperature
- Confirm with OK.

The adjusted target temperature is saved. The target and actual temperatures are displayed.

Rapid PreHeat

Rapid PreHeat can be used to speed up the preheating phase.

The Rapid PreHeat function turns on automatically if you set a temperature of more than 210°F (100°C) for Convection Bake , Auto Roast  or Surround .

Do not use Rapid PreHeat to preheat the oven when baking pizzas or delicates mixtures (e.g. small baked goods, sponge). These will brown too quickly.

You can turn-off Rapid PreHeat for a relevant cooking process.

Rapid PreHeat

– On

The Browning / Broiling and convection heating elements turn on together with the fan to enable the oven to reach the required temperature as quickly as possible.

– Off

Only the heating elements associated with the cooking program are turned on.

To turn the Rapid PreHeat function off:

- Select Change.
- Select Additional Settings.
- Select Rapid PreHeat.

In Rapid PreHeat, Off will appear.

- Confirm with OK.

Rapid PreHeat has been deactivated.

Instead of Rapid PreHeat, Preheating will appear in the display.

- Select the required oven mode and temperature.
- Rapid PreHeat should be turned off when baking pizza or delicate mixtures.
- Wait for the preheating phase to complete.

A buzzer will sound when the set temperature is reached, if the buzzer is set (see "Settings").

- Place the food in the oven.

Solo modes

Using the Crisp function (Moisture Reduction)

It is a good idea to use this function when cooking items which are moist on the inside but which should be crispy on the outside, e.g. french fries, croquettes or breaded meats.

It is also suitable for fruit cakes, such as apple cake.

You have placed the food in the oven, selected a mode and set the temperature.

You can activate the "Crisp function" with any oven mode. It must be activated separately for a cooking process. For best results, activate it at the beginning of the cooking process.

- Select Change.
- Select Additional Settings.
- Select Crisp function.

In Crisp function, On will appear.

- Confirm with OK.

Moisture reduction is now activated.

Changing the oven mode

You can change the oven mode during operation.

- Select Change.
- Select Additional Settings.
- Select Change Operating Mode.
- Select the desired mode.

The new mode will appear in the display together with its default temperature.

- Change the temperature, if necessary.
- Confirm with OK.

The oven mode has been changed.

The times entered will be kept.

Setting additional durations

You have placed the food in the oven, selected a mode and set the temperature.

By entering **Duration**, **Ready at** or **Start at** you can automatically turn the cooking program on or off.

– Duration

Enter the cooking duration required. Once the duration set has elapsed, the heating will turn off automatically. The maximum duration that can be set is 12:00 hours.

A cooking duration cannot be entered if you are using the wireless roast probe. When using the roast probe, the cooking duration is determined by when the set core temperature is reached.

– Ready at

You can specify when you would like the cooking program to complete. The oven will turn off automatically at the time set.

A **Ready at** time cannot be entered if you are using the wireless roast probe. When using the roast probe the end time is determined by when the set core temperature is reached.

– Start at

Set the time you would like cooking to start at. The oven will turn on automatically at the time set.

Start at can only be used together with **Duration** or **Ready at**, except when using the wireless roast probe.

Solo modes

Turning off automatically

It is now 11:45. The food takes 30 minutes to cook and should be ready at 12:15.

Select **Duration** and set 00:30 h or select **Ready at** and set the time for 12:15.

The oven will turn off automatically after this duration has elapsed or the time set has been reached.

Setting the duration

- Select **Change**.
- Select **Additional Settings**.
- Set the cooking duration.
- Confirm with **OK**.

Setting the "Ready at" time

- Select **Change**.
- Select **Additional Settings**.
- In the **Ready at** field, set the time at which the food should be ready.
- Confirm with **OK**.

Turning on and off automatically

It is recommended to use the automatic On/Off feature when roasting. Do not delay the start of the program for too long when baking. Cake mixtures and doughs will dry out, and the leavening agents will lose their effectiveness.

To turn a cooking program on and off automatically, you have a choice of how to enter the time parameters:

- **Duration and Ready at**
- **Duration and Start at**
- **Ready at and Start at**

It is now 11:30. The food takes 30 minutes to cook and should be ready at 12:30.

- Select **Change**.
- Select **Additional Settings**.
- In the **Duration** field, set 0:30 h.
- In the **Ready at** field, set 12:30 h.
- Confirm with **OK**.

The **Start at time** will be automatically calculated. **Start at 12:00** will appear in the display.

The oven will turn on automatically when this time is reached.

Sequence of a cooking program that turns on and off automatically

Up until the start time the mode, the selected temperature, *Start at* and the start time will appear in the display.

After the program has started you can follow the preheating phase in the display until the required temperature has been reached.

Once this temperature is reached, a buzzer will sound if turned on (see "Settings - Volume - Buzzer tone").

After the preheating phase the remaining time will appear in the display.

The time will count down in the display. The last minute counts down in seconds.

At the end of the cooking process a buzzer will sound if turned on (see "Settings - Volume - Buzzer tones").

The oven heating and lighting are turned on. *Program Finished* appears in the display.

You have the option to save the program as a Favorite (see "Favorites") or to increase the cooking duration using *Change*. Select "Back" to go back to the main menu.

During the cooling down phase the cooling fan will continue to run.

Changing the set time

- Select *Change*.

All options that can be changed will appear.

- Change the desired time.
- Confirm with OK.

These settings will be deleted in the event of a power failure.

Canceling cooking

- Touch "Back" twice.

Cancel Cooking? appears in the display.

- Select *Yes*.

The oven heating and lighting will turn off, and any durations set will be deleted.

Microwave (Solo)

Quick Guide

- Turn on the oven.

The main menu will appear.

- Place the food in the oven.
- Select Operating Modes .
- Select Microwave .

The mode, recommended power level and the duration field will appear in the display.

- If necessary, change the recommended power level.
- Set the cooking duration.

The maximum duration that can be set depends on the power level selected.

- Select Start.

The magnetron, lighting and cooling fan will come on and the cooking program will start.

The time remaining appears in the display. You can interrupt the cooking at any time with Stop.

At the end of the cooking duration

- Program Finished appears in the display.
- the cooling fan will continue to run,
- A buzzer will sound if turned on (see "Settings - Volume - Buzzer tones").

You have the option to save the program as a Favorite (see "Favorites") or to increase the cooking duration using Change. Select "Back" to go back to the main menu.

- Take the food out of the oven.
- Turn the oven off.

Cooling fan

After the cooking process the cooling fan will continue to run for a while after a program is complete to prevent moisture from building up in the oven, on the control panel or surrounding cabinetry.

The cooling fan will turn off after a set time.

Additional functions

You have placed the food in the oven, selected a Microwave power level and set the duration.

By selecting Additional Settings you can adjust cooking times and adjust additional settings.

- Select Change.
- Select Additional Settings.

Additional options will appear in the display for you to select for change if desired.

- Ready at
- Start at
- Change Operating Mode (You can change the oven mode during operation.)

Changing the microwave power level

In Microwave (Solo)  the power level is set at the factory to level 7.

- If the default power level is suitable for your recipe, confirm it with OK.
- If it is not suitable for your recipe, you can change it for this particular cooking program.

You can also permanently reset the recommended power level to suit your personal cooking practices (See "Settings - MW power levels").

- Select Change.
- Change the power level and wait about 15 seconds.

The cooking process is now running with the modified microwave power level.

Changing the cooking duration

- Select Change.
- Change the cooking duration.
- Select Start.

The program will restart using the new duration.

Changing the oven mode

You can change the oven mode during operation (see "Solo modes - Changing the oven mode").

Microwave (Solo)

Setting additional durations

You have placed the food in the oven, selected a Microwave power level and set the duration.

By entering **Ready at** or **Start at** you can automatically turn the cooking program on or off.

– Ready at

You can specify when you would like the cooking program to complete.

The oven will turn off automatically at the time set.

A **Ready at** time cannot be entered if you are using the roast probe. When using the roast probe the end time is determined by when the set core temperature is reached.

– Start at

Set the time you would like cooking to start at. The oven will turn on automatically at the time set.

Turning on and off automatically

To turn a cooking program on and off automatically, you have a choice of how to enter the time parameters:

– Duration and Ready at

– Duration and Start at

It is now 11:45. The food takes 5 minutes to cook and should be ready at 12:30.

■ In the **Duration** field, set 5:00 h.

■ Select **Additional Settings**.

■ In the **Ready at** field, set 12:30 h.

■ Confirm with **OK**.

The **Start at** time will be automatically calculated. **Start at 12:25** will appear in the display.

The oven will turn on automatically when this time is reached.

Sequence of a cooking program that turns on and off automatically

Up until the start time the mode, the microwave power level, the selected temperature, Start at and the start time will appear in the display.

After starting the time remaining will appear in the display.

You can follow the time counting down in the display.

At the end of the cooking process a buzzer will sound if turned on (see "Settings - Volume - Buzzer tones").

The magnetron and the oven light turn off. Program Finished appears.

You have the option to save the program as a Favorite (see "Favorites") or to increase the cooking duration using Change. Select "Back" to go back to the main menu.

Changing the set time

- Select Change.
- Select Additional Settings, if required.

All options that can be changed will appear.

- Change the desired time.
- Select OK to confirm or select Start, if the cooking is already in progress.

These settings will be deleted in the event of a power failure.

Deleting a finish time

- Select Change.
- Select Additional Settings.
- In the field Ready at set the time to "- - -".
- Select Start.

The finish time is now deleted.

The program will start using the duration set.

Canceling cooking

- Touch "Back" twice.
- Cancel Cooking? appears in the display.
- Select Yes.

The Main Menu will appear. Any cooking durations set will be deleted.

Combi Modes

Microwave Combi modes use microwave power with another cooking mode (e.g. Convection Bake, Auto Roast). This combination enables shorter cooking durations.

Quick Guide

- Turn on the oven.

The main menu will appear.

- Place the food in the oven.
- Select Operating Modes .
- Select the desired mode.

The mode, recommended power level, recommended temperature and the duration field will appear in the display.

In the Combi modes, the maximum microwave power level is 3. The recommended temperature with the possible temperature range for each mode is described in "Guide to the modes".

- Set the microwave power level, temperature and cooking duration.

You can set a maximum duration of 2:00 hours.

- Select Start.

The oven cooking will start. The oven heating, lighting and cooling fan will turn on.

The microwave power level, cooking time, set temperature and actual temperature will appear. You can watch the temperature rise in the display. When the selected temperature is reached a signal will sound (see "Settings - Volume - Buzzer tone").

The remaining time appears in the display.

At the end of the cooking duration

- Program Finished appears in the display.
- the oven heating turns off automatically,
- the cooling fan will continue to run,
- A buzzer will sound if turned on (see "Settings - Volume - Buzzer tones").

You have the option to save the program as a Favorite (see "Favorites") or to increase the cooking duration using Change. Select "Back" to go back to the main menu.

- Take the food out of the oven.
- Turn the oven off.

Cooling fan

After the cooking process the cooling fan will continue to run for a while after a program is complete to prevent moisture from building up in the oven, on the control panel or surrounding cabinetry.

When the temperature in the oven has fallen sufficiently the cooling fan will turn off automatically.

The default setting can be changed if desired (see "Settings - Cooling Fan").

Additional functions

You have placed the food in the oven, selected a temperature, Microwave power level and set the duration.

By selecting Additional Settings you can adjust cooking times and adjust additional settings.

- Select Change.
- Select Additional Settings.

Additional options will appear in the display for you to select for change if desired.

- Ready at
- Start at
- Duration MW
- Change Operating Mode (You can change the oven mode during operation.)

Combi Modes

Changing the microwave power level and temperature

- Select Change.
- Change the microwave power level or the temperature.
- Confirm with OK.

The adjusted value is now saved and will appear in the display.

Using the Crisp function (Moisture Reduction)

You can activate or deactivate the Crisp function (see "Solo modes - Using the Crisp function (Moisture reduction)").

Changing the oven mode

You can change the oven mode during operation (see "Solo modes - Changing the oven mode").

Setting additional durations

You can set a program to turn on and off automatically (see "Microwave (Solo)  - Setting additional durations").

Setting the duration for microwave cooking

You can select how long you want microwave power to be on for at the beginning of a Microwave Combi mode. This can be useful, e.g. when baking, to help the dough rise more efficiently.

- Select Change.
- Select Additional Settings.
- In the field Duration MW set the cooking duration.
- Confirm with OK.

Your oven has a wide range of MasterChef programs that enable you to achieve excellent cooking results with ease. Simply select the appropriate program for the type of food you are cooking and follow the instructions in the display.

List of food types

The programs can be found under Gourmet Center .

- Bakes & Gratins
- Baked Goods
- Meat
- Fish
- Poultry
- Cook Veg with MW
- Pizza
- Cook Soup with MW

Using the Gourmet Center programs

From the main menu:

- Select Gourmet Center .

A list of food types will appear in the display.

- Select the food category.

The programs available for the food category selected will appear.

- Select the desired program.

Each step you need to take before starting the program will appear in the display.

Depending on the program selected the following information or instruction will appear in the display:

- Type of cookware,
- Shelf level,
- Using the roast probe,
- Duration.

- Follow the instructions in the display.

Gourmet Center

Notes on using these programs

- The oven interior should be at room temperature before starting a MasterChef program.
- Some programs require a preheating phase before food is placed in the oven. A prompt will appear to tell you when to add the food.
- The duration quoted for MasterChef programs is an estimate. It may increase or decrease depending on the program. When using the roast probe, the duration will be determined by when the core temperature is reached. The duration, in particular with meat, will vary depending on the initial temperature of the food.

Search

You can search *Gourmet Center* by food type and by the name of the program.

There is a full text search which can also be used to search for parts of words.

From the main menu:

- Select *Gourmet Center*.

A list of food types will appear in the display.

- Select *Search*.

- Use the keyboard to type in the search text, e.g. "Bread".

The number of hits will be shown in the bottom right of the display.

If no match is found, or if there are more than 40 matches, the *hits* field will be deactivated and you will need to change the search text.

- Select *hits*.

The food types and programs available will then appear.

- Select the program or the food type, and choose the program

The program will start.

- Follow the instructions in the display.

You can create and save up to 20 of your own programs.

- Each one can have up to 10 cooking stages. This enables you to save your most frequently used recipes very accurately. Each stage contains a mode, temperature and duration or core temperature.
- You can specify the shelf level(s) for the food.
- You can enter a program name for your recipe.

When you next select the program, it will start automatically.

There are different ways of creating a Favorite:

- At the end of running a MasterChef Program, save it as a separate program.
- After running a program with a set duration, select **Save**.

Then name the program.

Creating a Favorite

- Select **Favorites**.
- Select **Create Program**.

You can now specify the settings for cooking stage 1.

Follow the instructions in the display:

- Select and confirm the cooking mode, temperature and duration or core temperature.

Depending on the mode selected you can add the functions **Rapid PreHeat** and **Crisp** function in **Additional Settings**.

Settings for the 1st cooking stage have now been set.

More cooking stages can be added, for example, if you would like to add another cooking mode to follow the first.

- If additional cooking stages are required, select **Add** and proceed as you did for the 1st cooking stage.
- When you have completed setting the cooking stages, select **Finish**.

Set the shelf level(s) to be used:

- Select the desired level(s).
- Confirm with **OK**.

A summary of your settings will appear in the display.

- Check the settings and select **OK** to confirm, or select **Change** to correct the settings.
- Select **Save**.
- Enter the program name using the keyboard.

Favorites

You can add a line break for longer program names using the ↵ symbol.

- Once you have entered the program name select **Save**.

A message will appear in the display confirming that the name has been saved.

- Confirm with **OK**.

You can start the saved program immediately, delay the start or change the cooking stages.

More information regarding **Change Cooking Stages** can be found in "Changing favorites".

Starting a Favorite

- Place the food in the oven.

- Select **Favorites**.

The program names will appear in the display.

- Select the desired program.

You can start the saved program immediately, delay the start or show the cooking stages.

- Start Now

The program will start right away and the oven heating will turn on.

- Start Later

This option will only appear if you are using the wireless roast probe. You can specify when you would like the program to start. The oven heating will turn on automatically at the time set.

- Ready at

You can specify when you would like the cooking program to complete. The oven will turn off automatically at the time set.

- Start at

You can specify when you want the program to start. The oven heating will turn on automatically at the time you set.

– Display Stages

A summary of your settings will appear in this display. You can adjust the setting under **Change** (see "Changing Favorites").

- Select the desired menu item.
- Confirm the message regarding which shelf level to use with **OK**.

The selected program will begin automatically right away or at the time set.

Changing Favorites

Changing cooking stages

Cooking stages in a MasterChef program that have been saved under a different name cannot be changed.

- Select **Favorites**.

The program names will appear in the display.

- Select **Edit**.
- Select **Change Program**.
- Select the desired program.
- Select **Change Cooking Stages**.

The setting specified for a cooking stage can be changed or more cooking stages can be added to the program.

- Change the program as desired (see "Creating a Favorite").
- Check the settings and select **OK** to confirm.
- Select **Save**.
- If necessary, change the name (see "Creating a Favorite") and select **Save**.

The changes made to the program will be saved.

Favorites

Changing the name

- Select Favorites.

The program names will appear in the display.

- Select Edit.
- Select Change Program.
- Select the desired program.
- Select Change name.
- Change the name (see "Creating a Favorite) and select Save.

A message will appear in the display confirming that the name has been saved.

- Confirm with OK.

The new program name will be saved.

Deleting a Favorite

- Select Favorites.

The program names will appear in the display.

- Select Edit.
- Select Delete Program.
- Select the desired program.
- Select Yes.

The program is deleted.

You can delete all of your Favorites at the same time (see "Settings - Factory Default - Favorites").

With the Minute + function the microwave starts with a set microwave power level and cooking time, e.g. heating liquids.

The default power level is 7 with a cooking time of 1 minute.

Tip:: You can alter the power level and the duration. The maximum duration will depend on the microwave power level selected (see "Settings – Minute +").

This function can only be used when no other cooking programs are in use.

- Touch "Minute +" until the cooking process starts.
Touching it repeatedly will increase the cooking time.

The time remaining appears in the display.

You can stop the cooking process at any time with **Stop** and cancel with **"Back"**.

At the end of the program

- Program Finished appears in the display.
- A buzzer will sound if turned on (see "Settings - Volume - Buzzer tones").

Popcorn

With the Popcorn function, the microwave starts with a set microwave power level and cooking duration.

The microwave power level is preset at 6 and the duration at 3 minutes. This is suitable for most brands of microwave popcorn.

Tip:: The duration can be changed up to a maximum of 4 minutes. The microwave power level cannot be changed (see "Settings – Popcorn").

This function can only be used when no other cooking programs are in use.

- Touch "Popcorn" until the program starts.

The time remaining appears in the display.

You can stop the cooking process at any time with **Stop** and cancel with **"Back"**.

Do not leave the oven unattended during this program and follow the manufacturers instructions.





At the end of the program

- Program Finished appears in the display.
- A buzzer will sound if turned on (see "Settings - Volume - Buzzer tones").

Eating food which has been cooked correctly is important for good health.

Only bake cakes, pizza, french fries, etc. until they are golden brown. Do not overcook them.

Oven modes



Depending on how you would like the food prepared, you can use Convection Bake , Surround , Intensive , or Combi Bake  (see "Guide to the modes").

Combi Bake is particularly suitable for baking doughs with a longer baking time, because the cooking time is shortened.

For baking, the microwave power level must not exceed level 2.

Bakeware

The bakeware used depends on the oven mode chosen and how the food is prepared.

- Convection Bake , Intensive : Bakeware made of any heat-resistant material is suitable. Light-colored, thin, non-reflective metal baking pans can be used, but results may not be as good as with dark non-reflective bakeware.

- Surround : Dark metal, enamel or aluminum baking tins with a matte finish, as well as heat-resistant glass, ceramic and coated dishes can be used. Avoid bright, shiny metal tins as they result in uneven or poor browning, and in some cases cakes might not cook properly.

- Combi Bake : Only use oven-safe dishware suitable for microwave use (see "Containers suitable for microwave use"), such as oven-safe glass or ceramic dishes as these allow microwaves through them. Metal containers reflect microwaves so food will only cook from above. Cooking durations would therefore be longer and metal tins could also cause sparking. Place the dish on the glass tray such that it cannot touch the oven walls. If the dish being used causes sparking, do not use it for combination cooking programs again.

Parchment paper

Place french fries, croquettes and similar types of food on paper.

Bake

Temperature

As a general rule, select the lower temperature given in the chart.

Choosing a baking temperature higher than those recommended may reduce the cooking time, but will lead to uneven browning, and unsatisfactory cooking results.

Baking duration

Check if the food is cooked at the end of the shortest duration quoted. To check if a cake is ready insert a wooden skewer or toothpick into the center, it should come out clean.

Shelf levels

The shelf level that you place the food on for baking depends on the oven mode and the number of trays being used.

– Convection Bake

Cakes in pans: Level 1 from the bottom

Flat baked goods (e.g. cookies, cakes): Level 2 from the bottom

Baking on 2 levels at the same time:
Levels 1+3 from the bottom or levels 2+3 from the bottom

– Surround

Cakes in pans: Level 1 from the bottom

Flat baked goods (e.g. cookies, cakes): Level 2 from the bottom

– Intensive

In general use Level 1 from the bottom.

– Combi Bake

Insert the glass tray on Level 1 from the bottom and place the bakeware on it.

Tips

- Setting the cooking duration. When baking, the oven should not be set to start after an extended period of time. Otherwise the cake mixture or dough will dry out, and the raising agents will lose their effectiveness.
- Place cakes in rectangular bakeware on the rack with the longer side across the width of the oven for optimum heat distribution and even results.

Always follow USDA guidelines on food safety.

Oven modes

Convection Bake / Convection Roast

 , **Auto Roast** 

For roasting meat, fish and poultry dishes in which a browned finish is desired.

Combi Bake

Combi Auto Roast 

The program duration is shorter with these modes.



Set the microwave to the following levels for the entire cooking duration.

- For meat and fish: max. level 3.
- For poultry: level 2.



This combination mode is **not** suitable for cooking roast beef or tenderloins. The center would be too well cooked before the exterior is browned.

Cookware

Please take into account the material of your bakeware in your choice of oven mode:

- Convection Bake / Convection Roast  / Auto Roast :
Oven dishes, ovenproof ceramic dishes and glass dishes.

Make sure that the pot and lid have heat-resistant handles.

- Combi Bake  / Combi Auto Roast :

Dishes must be suitable for use in a microwave oven and must not have metal lids (see "Containers suitable for microwave use").

Roasting in a closed pan

- Season the meat and place it in the roasting dish. Dot with butter or brush with oil if necessary. For large lean cuts of meat 4.5-6.5 lbs (2-3 kg) and fatty poultry, add about 1/2 cup (1/8 l) of water to the dish.
- When using a roasting bag, follow the manufacturer's instructions.

Roasting on the rack

Add a little fat or oil to very lean meat or place a few strips of bacon on the top.





Do not add too much liquid during cooking as this will hinder the browning process.

Roast

Temperature

As a general rule, select the lower temperature given in the chart. If higher temperatures are used, the meat will brown on the outside, but will not be properly cooked through.

Shelf levels

- Convection Bake / Convection Roast  / Auto Roast :
Rack with meat on it on shelf level 1
- Combi Bake  /
Combi Auto Roast :
Rack or glass tray with meat on it on shelf level 1

Tips

- Resting time: At the end of the program, take the roast out of the oven, cover with aluminum foil and let stand for about 10 minutes. This helps retain the juices when the meat is sliced.
- The larger the cut of meat to be roasted, the lower the temperature should be. The roasting process will take a little longer, but the meat will be cooked evenly and the outside will become crisp.
- Use a roast probe for accurate cooking temperatures and best results.

Roast Probe

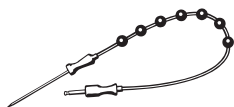

The roast probe enables the roasting process to be monitored simply and reliably.

How the roast probe works









The metal tip of the roast probe is inserted into the food. There is a temperature sensor in the metal tip which measures the core temperature of the food during cooking. The rise in the core temperature reflects the extent to which the food is cooked. You can program the core temperature to be lower or higher, depending on how you would like the meat cooked, rare, medium or well-done.

A core temperature of up to 210°F (99°C) can be set. Please refer to the roasting chart and "Slow cooking" for the core temperatures applicable for different types of meat.

The cooking time will be similar when cooking with or without the roast probe.

When to use the roast probe

Apart from MasterChef programs, Special Modes and Favorites, the roast probe can be used with the following oven modes:

- Auto Roast 
- Convection Bake / Convection Roast 
- Surround / Surround Roast 
- Convection Broil 
- Microwave 
- Combi Auto Roast 
- Combi Bake 
- Combi Broil 

Roast

Important notes regarding the roast probe

Please note:

- You can place the meat in a pot, on the rack or in the glass tray, depending on the mode selected.
- The metal tip of the roast probe must be fully inserted into the center of the food.
- When cooking poultry, insert the metal tip into the thickest part of the breast. You can find the thickest part of the breast by pressing the area with your thumb and index finger.
- Do not let the metal tip touch any bones or insert it into a fatty area of the meat. If fat or bone come into contact with the probe, this can lead to the oven being turned off too early.
- If the meat is very heavily marbled with fat, select the highest core temperature given in the roasting chart.
- When using roasting bags or aluminum foil, insert the probe through the bag or foil into the center of the meat. You can also place the meat, with the roast probe inserted, inside the foil. Follow the roasting bag / aluminum foil manufacturer's instructions.

Using the roast probe

- Insert the metal tip of the roast probe fully into the food.
- Place the food in the oven.

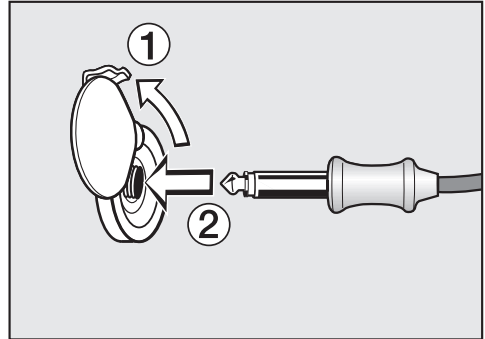

- Insert the plug of the roast probe into the socket until you feel it engage.
- Close the door.
- Select an oven mode or MasterChef program.
- Set the temperature or power level if necessary.
- Set the core temperature if necessary.

The core temperatures cannot be changed for the MasterChef programs.

You can also delay the start of the cooking program to a later time. To do this, select *Start at..* In the MasterChef programs select *Start Later*.

You can estimate approximately when the food will be ready as the duration of the cooking program is about the same as if you were cooking food without using the roast probe.

Duration and *Ready at* cannot be set because the total time depends on how long it takes for the core temperature to be reached.

Time left display

After a certain time, the estimated duration of the cooking process remaining (time left) will appear in the display.

The time left is calculated from the cooking temperature selected, the required core temperature and the pattern of the increasing core temperature.

The time left first shown is an estimate. As the cooking process continues, the time is revised continuously, and a more accurate figure is shown.

The time left will be deleted if the cooking or core temperature is changed or if a different mode is selected. If the door is opened for a longer time, the time left will be recalculated.

Roast

Displaying the core temperature

As soon as the time remaining appears, you can also display the actual core temperature.

- Select Change.
- Select Display core temperature.
- Select On.
- Confirm with OK.

The actual core temperature will also appear in the display.

Using residual heat

Shortly before the end of the cooking program the oven heating will turn off. The residual heat in the oven is sufficient to complete the cooking process.

Using the residual heat in the oven saves energy.

Energy Save Phase will appear in the display to show that the oven is in energy save mode. The measured core temperature is no longer visible.

The cooling fan and hot air fan (if turned on) will continue to run.

When the selected core temperature has been reached,

- Program Finished appears in the display,
- A buzzer will sound if turned on (see "Settings - Volume - Buzzer tones").

Tip:: If the food is not sufficiently cooked, insert the probe into another place and repeat the program.

This cooking method is ideal for cooking beef, pork, veal or lamb when a tender result is desired.

First, using a cooktop sear the meat on all sides to seal in the juices.

Then place the meat in a preheated oven. It will be cooked at a low temperature for an extended time allowing the meat to become very tender.

The meat will rest and the juices start to circulate evenly throughout.

This gives the meat a very tender and juicy result.

Tips

- Use fresh, lean meat that has been trimmed. Remove the bones before cooking.
- When searing, use a suitable cooking oil or fat that can withstand high temperatures (e.g. clarified butter, vegetable oil).
- Do not cover the meat during cooking.

Cooking will take approx. 2-4 hours, depending on the size and weight of the meat, as well as the desired degree of doneness and browning.

Cooking duration 🕒 / Core temperatures ⚡

Always follow USDA guidelines on food safety.

Meat	🕒 [min]	⚡ [°F / °C]
Sirloin		
– rare	50–70	118/48
– medium	100–130	135/57
– well done	160–190	156/69
Pork Tenderloin	80–100	145/63
Smoked Pork Chop *	140–170	154/68
Veal Loin *	100–130	145/63
Saddle of Lamb *	50–80	140/60

* boneless

After the cooking process

Because the cooking temperatures are very low:

- the meat can be carved immediately, it does not need to rest.
- the cooking result will not be affected if the meat is left in the oven after the program is complete. It can be kept warm until you serve it.
- the meat is at an ideal temperature to eat right away. Serve on heated plates with a hot sauce or gravy to keep it warm.

Slow Roasting

Using the Slow Roasting function

Use the glass tray with the wire oven rack placed on top of it.

- Select Special Modes .
- Select Slow Roasting.
- Set the required temperature.
- Set the core temperature.
- Follow the instructions in the display. Let the wire oven rack with glass tray preheat in the oven.
- While the oven is preheating, sear the meat on all sides on the cooktop.



Danger of burns!

When the oven is hot use pot holders to insert, remove or turn the food, or when adjusting the oven shelves, etc.

- Once Use the roast probe appears in the display, place the seared meat on the rack and insert the roast probe, so that the metal tip is fully in the center of the meat.

For more information see "Roasting - Roast probe".

- Place the glass tray with the rack on top into the oven on the shelf level suggested.



Use Caution!

The Browning / Broiling element will be hot. Danger of Burns!

- Insert the plug of the roast probe into the socket until you feel it engage.

- Close the door.

When the program is completed Program Finished will appear in the display and a buzzer will sound, if turned on (see Settings - Volume - Buzzer tone").

If the meat is not cooked to your satisfaction you can extend the cooking time.

Adjusting the Slow Roasting temperature

Use the glass tray with the wire oven rack placed on top of it.
Do not use the Rapid PreHeat function to preheat the oven.

- Place the glass tray with the wire oven rack on shelf level 1.
- Select Operating Modes.
- Select Surround  and a temperature of 265°F (130°C).
- Change the preheating function by selecting Change - Additional Settings - Rapid PreHeat - Off.
- Preheat the oven along with the glass tray and wire rack for approx. 15 minutes.
- While the oven is preheating, sear the meat on all sides on the cooktop.

Danger of burns!

When the oven is hot use pot holders to insert, remove or turn the food, or when adjusting the oven shelves, etc.

- Place the seared meat on the wire oven rack.
- Select Change.
- Reduce the temperature to 210°F (100°C).
- Continue cooking until the end of the cooking duration.

You can set the cooking process to automatically finish (see "Solo modes – Setting additional durations").

Broil



Danger of burns!

Broil with the oven door closed. If you broil with the door open the hot air will escape from the oven before it has been cooled by the cooling fan.

The controls will get hot.

Oven modes

Maxi Broil

For broiling thin cuts of meat and browning.

The entire Browning / Broiling element will get hot and glow red.

Convection Broil

Use this function for thick pieces of meat, London broil.

The Browning / Broiling element and the fan turn on alternately.

Micro Broil

 / **Combi Broil**

The broiling duration is shorter.

The maximum adjustable microwave power level is 3.

Cooking accessories

- Broiling on the wire oven rack.
- Brush the rack with oil, and place the food on it. It is best to broil food of a similar thickness at the same time so that the broiling duration for each item does not vary too greatly.

Broil level (Maxi Broil

 / **Micro Broil**)

- Level 3: Thin cuts are cooked quickly when placed close to the Browning / Broiling element
- Level 2: For lighter browning, e.g. casseroles.
- Level 1: Thicker cuts should be broiled further from the Browning / Broiling element.

Temperature

 (Convection Broil , Combi Broil)





As a general rule, select the lower temperature given in the chart. If higher temperatures are used, the meat will brown on the outside but will not be properly cooked through. Thin cuts can generally be broiled at 425°F (220°C), thicker cuts at 355-395°F (180-200°C).

Preheating

Always preheat the oven for about 5 minutes with the door closed before Broiling.

Do not set a microwave power level during pre-heating.

Shelf levels

- Maxi Broil , Micro Broil :
Use shelf level 2 or 3 depending on the thickness of the food.
- Convection Broil , Combi Broil :
Use self level 1 or 2 depending on the thickness of the food.

Testing doneness

Always follow USDA guidelines for safe food temperatures.

Preparing food for broiling

Rinse the meat under cold water and pat dry. Do not season the meat with salt before broiling, this will draw out the juices.

Brush the meat with oil, if necessary. Do not use other types of fat as they can easily burn and cause smoke.





Clean fish as usual. To enhance the flavor, salt or lemon can be added.

Broil

Broil

- Preheat the Browning / Broiling element for approx. 5 minutes with the door closed.

Do not set a microwave power level during preheating.

- Place the food on the wire rack.
- Select a mode, microwave power level and a broil setting for the Maxi Broil  and Micro Broil  modes.
- Select a mode, microwave power level and a temperature for the Convection Broil  and Combi Broil  modes.









Danger of burns!

When the oven is hot use pot holders to insert, remove or turn the food, or when adjusting the oven shelves, etc.

- Place the food on the appropriate shelf level.
- Close the door.

Microwave: Defrosting/Reheating/Cooking

Always follow USDA guidelines on food safety.

	Oven modes	 / 	Suitable for:
Defrost		1	Very delicate foods such as cream, butter, filled sponge cakes, cheese
		2	all other foods
Reheat		4	Food for infants and children
		5	All types of food; frozen meals that do not need browning
		6	
		7	Drinks
Cooking		6 Heating-up	Casseroles; puddings; frozen foods that do not need browning
		4 Continued cooking	
		2 Simmering	
	Select a Microwave Combi mode if you want to shorten cooking durations and have a crisp finish to the dish.		
		3 + 320-355°F (160-180°C)	Sear using a high temperature to start with, then continue cooking with a lower temperature.
	3 + 300-340°F (150-170°C)	Ready-meals which need to be browned, e.g. gratins	

 Microwave/Microwave power level /  Combi Auto Roast /  Combi Bake /  Temperature

The duration required depends largely on the nature of the food, the amount and its initial temperature. Food that has been refrigerated, for example, takes longer to reheat than food at room temperature. Please refer to the relevant charts.

Microwave: Defrosting/Reheating/Cooking

Before defrosting, reheating and cooking



- Place food (frozen or unfrozen) in a dish that is suitable for microwave use, and cover it.
- Place the dish in the middle of the glass tray on shelf level 1.

The roast probe can be used to monitor the temperature when reheating or cooking (see "Roast - Roast probe").

With Microwave Combi modes

- Use only microwave-safe and heat-resistant cookware.

A lid is not usually required.

Never use a lid with the Combi Auto Roast  and Micro Broil  modes as the food will not brown.

- Place the glass tray on shelf level 2.

Place pre-made meals in aluminum containers directly on the glass tray.

During the defrosting, reheating and cooking process

- Turn or stir the food several times. Stir the food from the outside towards the middle, as food heats more quickly from the outside.

After defrosting, reheating and cooking

Compensating times are resting periods in which the temperature is uniformly distributed in the food.

- Allow the food to stand at room temperature for a few minutes to enable the heat to spread evenly throughout the food.

 **Danger of burns!**

After reheating food, especially food for babies and small children, stir the food or shake the container and check that the temperature does not pose any danger. Double check after it has been left to stand.

 **Danger of burns!**

Be careful when removing dishes from the appliance. Although heat is not normally produced in the container itself by the microwaves (apart from stoneware), heat transfer from the food to the container may be considerable, making the container itself hot.

Use pot holders when removing dishes.

- Always ensure that food is sufficiently cooked or reheated.
- Always follow proper food safety guidelines.

Microwave: Defrosting/Reheating/Cooking

Tips on reheating

 Danger of burns! Food for infants and children must not be too hot. Heat baby food for only approx. 30-60 seconds at microwave power level 4. You can also use the roast probe for temperature controlled heating.

Otherwise pressure can build up, causing the container to explode, posing a severe risk of injury. Do not cook or reheat food or liquids in sealed containers, jars or bottles. Otherwise pressure will build up which can cause the bottle or container to explode. Risk of injury.

The boiling wand ensures that the liquid heats up evenly with bubbles forming at the right time. When reheating liquids place the boiling wand supplied into the cup or glass.

Eggs may burst. Never reheat hard boiled eggs using Microwave (Solo) , even without the shell. The eggs can explode.

Cooking tips

Food with a thick skin or peel, such as tomatoes, sausage, potatoes and egg plant can burst when heated. Pierce or score the skin of these foods several times to allow steam to escape.

Eggs heated in their shell can burst, even after removed from the oven. Eggs can only be cooked in their shells using Microwave (Solo)  in a specially designed egg-boiling device available from speciality stores.

When heating shelled eggs, the yolk may still burst after cooking. Prick the yolk several times before cooking to avoid this.

Microwave: Defrosting/Reheating/Cooking

When to use	Notes
Defrosting large quantities of food at once, e.g. 4.5 lbs (2 kg) fish	The glass tray can be used on shelf level 1 for defrosting food.
Reheating food	Always cover food when reheating it, except when reheating fried food or food with breading.
Cooking vegetables	Add a little water to vegetables which have been kept stored. Vegetable cooking times depend on the texture of the vegetable. Fresh vegetables contain more water than vegetables which have been stored and usually cook more quickly.
Cooking frozen meals	Deep frozen meals can be defrosted and then reheated or cooked in one process. Follow the instructions on the package.

Tables for defrosting, reheating and cooking food using Microwave (Solo)



The following notes apply to all tables:

Always follow USDA guidelines on food safety.

- Take note of the recommended microwave power levels, durations and standing times. These take the consistency, the quantity and the initial temperature of the food into account.
- In general you are recommended to select the middle duration.
- Place the food on the glass tray and use shelf level 1.

Microwave: Defrosting/Reheating/Cooking

Table for defrosting food



	Quantity		 [min]	 [min] ¹⁾
Dairy products				
Cream	1 cup (250 ml)	1	13–17	10–15
Butter	1/2 lb (250 g)	1	8–10	5–10
Cheese slices	1/2 lb (250 g)	1	6–8	10–15
Milk	2 cups (500 ml)	2	14–16	10–15
Quark	1/2 lb (250 g)	2	10–12	10–15
Baked Goods				
Pound Cake (1 slice)	approx. 1/4 lb	2	1–2	5–10
Pound Cake	approx. 3/4 lb	2	4–6	5–10
Fruit Cake (3 slices)	approx. 3/4 lb	2	6–8	10–15
Butter Cake (3 slices)	approx. 3/4 lb	2	5–7	5–10
Cream Cake (1 slice)	approx. 1/4 lb	1	1:30	5–10
Cream Cake (3 slices)	approx. 3/4 lb	1	4–4:30	5–10
Yeast rolls, puff pastries (4 pieces)		2	6–8	5–10
Fruit				
Strawberries, raspberries	1/2 lb (250 g)	2	7–8	5–10
Currants	1/2 lb (250 g)	2	8–9	5–10
Plums	1 lb (500 g)	2	12–16	5–10
Meat				
Ground Meat	1 lb (500 g)	2	16–18	5–10
Chicken	2 lbs	2	34–36	5–10
Vegetables				
Peas	1/2 lb (250 g)	2	8–12	5–10
Asparagus	1/2 lb (250 g)	2	8–12	10–15
Beans	1 lb (500 g)	2	13–18	10–15
Red cabbage	1 lb (500 g)	2	15–20	10–15
Spinach	3/4 lb (300 g)	2	12–14	10–15

 Microwave Power Level /  Defrosting /  Resting Time

¹⁾ Allow food to stand at room temperature. During this resting time, the temperature will distribute throughout the food more evenly.

Microwave: Defrosting/Reheating/Cooking

Table for reheating food

	Quantity		 [min:sec]	 [min] ¹⁾
Drinks ²⁾				
Coffee (Drink temperature 140-150°F/60-65°C)	1 Drink (2/3 cup/200 ml)	7	00:50-1:10	-
Milk (Drink temperature 140-150°F/60-65°C)	1 Drink (2/3 cup/200 ml)	7	1:00-1:50 ³⁾	-
Boiling water	1 Bowl (1/2 cup/125 ml)	7	1:00-1:50	-
Baby bottle (milk)	approx. 3/4 cup	4	00:50-1:00 ³⁾	1
Mulled wine (Drinking temperature 140-150°F/60-65°C)	1 Glass (3/4 cup/200 ml)	7	00:50-1:10	-
Food ³⁾				
Baby Food (room temperature)	1 Jar (1/2 lb/200 g)	4	00:30-1:00	1
Cutlets, fried	1/2 lb (200 g)	5	3:00-5:00	2
Fish fillet, fried	1/2 lb (200 g)	5	3:00-4:00	2
Roast meat in gravy	1/2 lb (200 g)	5	3:00-5:00	1
Side dishes	1/2 lb (250 g)	5	3:00-5:00	1
Vegetables	1/2 lb (250 g)	5	4:00-5:00	1
Gravy	1 cup (250 ml)	5	4:00-5:00	1
Soup / Casserole	1 cup (250 ml)	5	4:00-5:00	1
Soup / Casserole	2 cups (500 ml)	5	7:00-8:00	1

 Microwave Power Level /  Reheating Time /  Resting Time

¹⁾ Allow food to stand at room temperature. During this resting time, the temperature will distribute throughout the food more evenly.

²⁾ Place the boiling wand supplied into the cup or glass.

³⁾ The times listed are for food with a starting temperature of approx. 40°F (5°C).

For dishes that are not commonly stored in the refrigerator, it is assumed that the room temperature is about 70°F (20°C).

Microwave: Defrosting/Reheating/Cooking

Table for cooking food

		Quantity	Level 6 ⌚ [min]	+	Level 4 ⌚ [min]	⌚ [min] ¹⁾
Meat						
Meatballs in sauce (3/4 lb/400 g meat)			10–12		–	2–3
Stew (1.5 lbs/750g meat)			16	+	15	2–3
Poultry						
Chicken in sauce	approx. 1 3/4 lb (800 g)		4	+	12	2–3
Chicken Curry	approx. 2 lbs (900 g)		5	+	12	2–3
Chicken Risotto	approx. 3 1/2 lbs (1.6 kg)		10	+	15	3–5
Fish						
Fillet in sauce	approx. 2 lbs (900 g)		8–10		–	2–3
Fish Curry	approx. 3 1/4 lbs (1.5 kg)		5	+	12	3–5
Fresh vegetables						
Carrots	3/4 lb (300 g)		2	+	6	2
Cauliflower florets	1 lb (500 g)		6	+	10	2
Peas	approx. 1 lb (450 g)		5	+	10	2
Peppers, cut into strips	1 lb (500 g)		5	+	10	2
Kohlrabi, batons	1 lb (500 g)		3	+	8	2
Brussels Sprouts	3/4 lb (300 g)		3	+	9	2
Asparagus	1 lb (500 g)		5	+	8	2
Broccoli, florets	3/4 lb (300 g)		4	+	4	2
Leeks	1 lb (500 g)		5	+	8	2
Green Beans	1 lb (500 g)		4	+	12	2
Frozen Vegetables						
Peas, Mixed Vegetables	approx. 1 lb (450 g)		5	+	11	2
Spinach	approx. 1 lb (450 g)		5	+	7	2
Brussels Sprouts	3/4 lb (300 g)		4	+	6	2
Broccoli	3/4 lb (300 g)		3	+	6	2
Leeks	approx. 1 lb (450 g)		4	+	8	2
Desserts						
Quark Soufflé (1 lb/500 g quark)			10–12		–	–
Fruit Compote (2 cups/500 ml fruit juice or 1 lb/500 g fruit)			6–8		–	–

⌚ Cooking / ⌚ Resting Time

¹⁾ Allow food to stand at room temperature. During this resting time, the temperature will distribute throughout the food more evenly.

Special Modes

In addition to the MasterChef programs your oven has a variety of Special Modes.

■ **Select Special Modes** .

The following Special Modes are available:

- Defrost
- Dehydrate
- Reheat
(to reheat plated meals)
- Warm-up Cookware
- Proof dough
- Slow Roasting
See "Slow Roasting" for more information.
- Pizza
- Sabbath Program

This section also gives information on the following applications:

- Gentle Bake
- Canning
- Frozen food

Defrost

Use the Defrost function to gently defrost frozen food.

Only use heat-resistant containers that are microwave safe.

- Select Special Modes .
- Select Defrost.
- Select the food category.
- Enter the weight of the food.
- Follow the instructions in the display.

Air is circulated throughout the cabinet to gently defrost the food.

 Danger of salmonella poisoning!
Observe proper hygiene rules when defrosting poultry.
Do not use the defrosting liquid.

Tips

- Remove the packaging and place the food to be defrosted on the glass tray.
- When defrosting poultry, put it on the rack over the glass tray to catch the defrosting liquid so that the meat is not lying in this liquid.

Special Modes

Dehydrate

This program is designed for traditional drying of food to preserve it.

The temperature can be set between 175-210°F (80-100°C).

It is important that fruit and vegetables are ripe and not bruised before they are dehydrated.

- Prepare the food for dehydrating.
 - Peel and core apples, and cut into slices 1/4" (0.5 cm) thick.
 - Core plums if necessary.
 - Peel, core and cut pears into wedges.
 - Peel and slice bananas.
 - Clean mushrooms, then either halve or slice them.
 - Remove parsley and dill from the stem.
- Distribute the food to be dried evenly over the glass tray or the rack.
- Select Special Modes.
- Select Dehydrate.
- If necessary, adjust the default temperature and set the duration.
- Follow the instructions in the display.

Food	Approx. dehydrating time
Fruit	2–8 hours
Vegetables	3–8 hours
Herbs*	50–60 minutes

* Because this program uses the fan, it is recommended that you use Surround  with a temperature of 175-210°F (80-100°C) for drying herbs.

- Reduce the temperature if condensation begins to form in the oven.

 **Danger of burns!**
Use pot holders when removing the dehydrated food from the oven.

- Allow the fruit or vegetables to cool down after dehydrating.

Dried fruit must be completely dry, but also soft and elastic. Juice should not escape when cut.

- Store in sealed glass jars or tins.

Reheat

This program is designed to reheat cooked food.

Only use heat-resistant containers that are microwave safe.

- Place the food to be reheated in a dish on the rack. Do not cover it.
- Select Special Modes .
- Select Reheat.
- Select the food category.
- Enter the weight of the food.
- Follow the instructions in the display.



Danger of burns!

Use pot holders when removing dishes from the oven. Condensation may accumulate on the bottom of the dish.

Warm-up Cookware

This program is designed to warm your cookware.

The temperature can be set between 120-175°F (50-80°C).

Use heat-resistant cookware.

- Place the rack on shelf level 1 and place the cookware to be heated on it.
- Select Special Modes.
- Select Warm-up Cookware.
- If necessary, adjust the default temperature and set the duration.
- Follow the instructions in the display.



Danger of burns!

Use pot holders when removing dishes from the oven. Condensation may accumulate on the bottom of the dish.

Special Modes

Proof

This program is designed specifically for proofing yeast dough.

The temperature can be set between 85 and 120°F (30 and 50 °C).

- Select Special Modes .
- Select Proof dough.
- If necessary, adjust the default temperature and set the duration.
- Follow the instructions in the display.

Pizza

This program is designed specifically for baking pizza.

The temperature can be set between 320-480°F (160-250°C).

- Select Special Modes.
- Select Pizza.
- If necessary, adjust the default temperature and set the duration.
- Follow the instructions in the display.

Sabbath Program

This program is designed for religious observance.

Select the Sabbath Program and then select the oven mode and temperature.

The program will only start once the door is opened and closed:

- The cooking process will start after about 5 minutes using Surround .
- The oven will heat up to the temperature you have set and will maintain this temperature for a maximum of 72 hours.
- The interior lighting does not come on, even when the door is opened.



If Settings - Lighting - On has been selected, the lighting will remain turned on throughout the program.

- Sabbath Program appears in the display constantly.
- The time of day is turned off.

Once the Sabbath Program has started it cannot be changed or saved as a Favorites.

Using the Sabbath Program

The program can only be canceled by turning the oven off.

- Select Special Modes .
- Select Sabbath Program.
- Select Surround .

The Sabbath Program cannot be started if the timer is being used.

- Set the required temperature.
- Confirm with OK.

The oven is now ready for use.

Sabbath Program  and the temperature set will appear.

- Open the door to start the program.
- Place the food in the oven.
- Close the door.

The oven heating will turn on after 5 minutes.

To end the program early:

- Turn the oven off.

Special Modes

Gentle Bake

The Gentle Bake mode is ideal for casseroles and gratins which require a crisp topping.

The temperature can be set between 210-480°F (100-250°C).

- Select Operating Modes.
- Select Gentle Bake and change the default temperature if necessary.
- Follow the instructions in the display.

Canning

Always follow the USDA canning guidelines.

Canning Containers



Danger of injury!

Do not use the appliance to heat up or can food in sealed jars or containers.

Pressure will build up inside them and they can explode causing damage to the appliance, as well as the risk of injury and scalding.

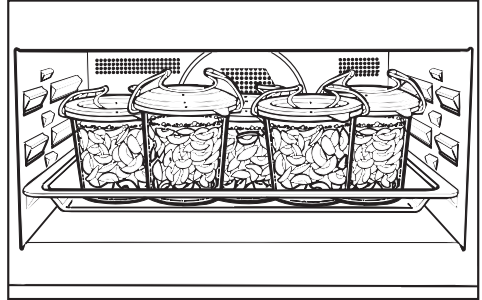

- Prepare the jars in the usual way. Fill the jars up to 3/4" (2 cm) below the rim.

Convection Bake

For canning large quantities of fruit and vegetables [max. 5 jars, 1/2 pint (1/2 l) each].

- Only use jars designed for canning:
 - Canning jars, or
 - Jars with twist-off lids.

Microwave

For canning small quantities of fruit and vegetables.

- Only use special jars for canning.

Sparking can be caused by metal brackets on jars!

Close the jars with clear adhesive tape or with clips suitable for microwave use. Never use metal clips or jars with screw-on lids.

Special Modes

Convection Bake

5 Jars 1/2 pint (1/2 liter) ¹⁾	Temperature	Time from simmering point ²⁾ [min]	Continued warming duration [min]
Fruit / Cucumbers	300-340°F (150-170°C) until simmering. Allow to stand in the turned off oven afterwards.	None	25-30
Asparagus, Carrots	300-340°F (150-170°C) until simmering. Then continue cooking at 212°F (100°C).	60-90	25-30
Peas, Beans		90-120	25-30

Microwave

5 Jars 1/2 pint (1/2 liter) ¹⁾	Microwave power level	Time until simmering point ²⁾ [min]	Time from simmering point ²⁾ [min]
Fruit / Cucumbers	Level 6 until simmering. Leave to stand in the turned off oven afterwards.	3-15 depending on number of jars	-
Asparagus, Carrots	Level 6 until simmering. Then continue cooking at level 4.	3-15 depending on number of jars	approx. 15
Peas, Beans			approx. 25

¹⁾ Glass tray on shelf level 1

²⁾ Simmering = Consistent bubbling

After canning



Danger of burns!
Use pot holders when removing the jars from the oven.

- Take the jars out of the oven.
- Cover the jars with a towel and leave to set for approx. 24 hours.
- Remove any clips or the adhesive tape.
- Make sure all jars are closed properly when storing them.

Special Modes

Frozen food

Tips

Cakes, pizza, baguettes

- Bake on parchment paper placed on the wire oven rack.
- Use the lowest temperature recommended by the manufacturer.

French fries, croquettes and similar items

- Place these frozen foods on the glass tray.
Place parchment paper underneath.
- Use the lowest temperature recommended by the manufacturer.
- Turn several times during cooking.

Preparation

Eating food which has been cooked correctly is important for good health.

- Select the oven mode and temperatures recommended by the manufacturer.
- Preheat the oven.
- Place the food in the preheated oven on the recommended shelf level.
- Check the food at the end of the shortest time recommended on the packaging.



Danger of burns!

Make sure the heating elements are turned off and allowed to cool completely.



Danger of injury! The steam from a steam cleaner could reach electrical components and cause a short circuit.

Do not use a steam cleaner to clean this appliance.

All surfaces can discolor or be damaged if unsuitable cleaning agents are used. The front of the oven, in particular, will be damaged by oven cleaners and descalers.

All surfaces are susceptible to scratches. Scratches on glass surfaces could cause a breakage.

Remove any cleaning agent residues immediately.

Stubborn soiling may damage the oven.

Once the oven has cooled clean the oven, the inside of the door and the door seal. Waiting too long to clean the oven will make it much more difficult to clean.

Check the door and door seal for any sign of damage. If any damage is seen, the oven should not be used again. Contact Miele.

Unsuitable cleaning agents

To better maintain your appliance avoid the following:

- cleaners containing soda, ammonia, thinners, or chlorides,
- cleaners containing descaling agents or lime removers,
- abrasive cleaning agents e.g. powder or cream cleansers, pumice stones,
- solvent-based cleaners,
- stainless steel cleaners,
- dishwasher soap (powder),
- glass cleaning agents,
- ceramic cooktop cleaner,
- hard, abrasive brushes or sponges, e.g. pot scourers, brushes or sponges which have been previously used with abrasive cleaning agents,
- eraser sponges,
- metal scrapers,
- steel wool or scouring pads,
- stainless steel spiral pads,
- spot cleaners,
- oven cleaners*.

* These can, however, be used to remove very heavy soiling from PerfectClean treated surfaces.

Soiling not removed immediately can become difficult to remove.

Continued use without cleaning will make the oven much harder to clean. Remove any soiling immediately.

Cleaning and care

Only the glass tray and the boiling wand are dishwasher-safe.

Tips

- Soiling caused by spilt juices and cake mixtures is best removed while the oven is still warm. Use caution and make sure the oven is not too hot - Danger of burns.
- The Browning/Broiling element can be lowered for easier cleaning.
- To neutralize odors in the oven, put a container of water with some lemon juice in the oven and heat for a few minutes.

Normal soiling

Moisture inside the oven can cause damage.

Wipe out the oven with a damp cloth so no excess moisture enters the interior of the appliance through the openings.

- Remove normal soiling immediately using a clean sponge with warm water and liquid dish soap applied with a clean, damp microfiber cloth.
- After cleaning, ensure that any detergent residue is removed with clean water. This is particularly important when cleaning surfaces treated with PerfectClean enamel as detergent residue can impair the non-stick properties.
- After cleaning, dry the surfaces with a soft cloth.

Roast Probe

Do not put the roast probe into water or clean it in the dishwasher, this will damage it.

Clean the roast probe with a damp towel.

Stubborn soiling

Fruit juices and roasting juices may cause permanent discoloration to the surfaces of the oven. This will not affect the performance of the oven. Do not use force to remove stains. Clean only as described in this manual.

- Moisten stubborn soiling with a solution of warm water and liquid dish soap, leave for a few minutes to take effect.
- If necessary, the rough side of a dish sponge can be used to remove the soiling.
- After cleaning, rinse thoroughly with clean water, and dry with a soft cloth.

- Stubborn soiling on PerfectClean surfaces can be cleaned using Miele Oven Cleaner. It must only be applied to cold surfaces in accordance with the instructions on the packaging.

Non-Miele oven spray must only be used in a cold oven and for no longer than 10 minutes.

- If necessary, the rough side of a dish sponge can be used to remove the soiling.
- After cleaning, remove all oven cleaning agent residues thoroughly with clean water, and dry with a soft cloth.

Cleaning and care

Lowering the Browning / Broiling element

If the oven interior is very dirty the Browning/Broiling element can be lowered. It is recommended to clean the oven interior with a damp sponge regularly.



Danger of burns!

Make sure the heating elements are turned off and allowed to cool completely.

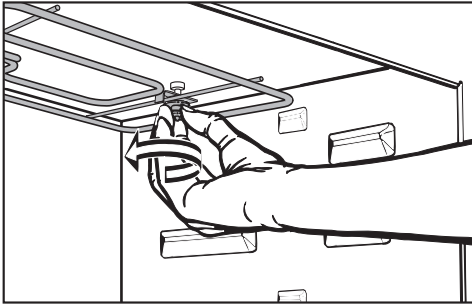

- Unscrew the nut and lower the Browning/Broiling element.

Use caution not to damage the Browning / Broiling element.
Do not use force to lower the Browning / Broiling element.

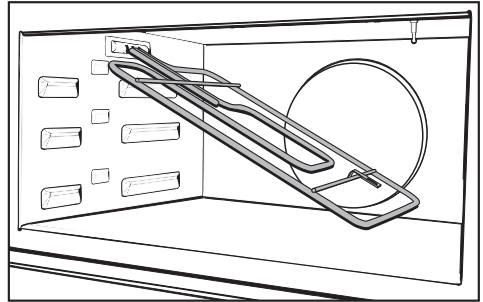

- Carefully lower the Browning / Broiling element.
- Clean the oven interior with a damp cloth or sponge.
- After cleaning, raise the Browning/ Broiling element gently back up again. Refit the nut and tighten to secure the element back in position.







Frequently asked questions

The following faults can be corrected without contacting the Miele Service Department. If in doubt, please contact Miele.

 **Danger of injury!** Repairs should only be carried out by a qualified and trained professional in accordance with local and national safety regulations. Unauthorized repairs could cause personal injury or machine damage.

Problem	Possible cause and solution
This display is dark.	<p>The time of day display is deactivated. When the appliance is turned off, the time of day display is turned off.</p> <ul style="list-style-type: none"> ■ As soon as the oven is turned on, the time of day will appear. If you want it to be displayed continuously, the setting to turn the time of day display back on must be changed (see "Settings – Time of day - Display").
	<p>There is no power to the appliance.</p> <ul style="list-style-type: none"> ■ Check if the circuit breaker has tripped.
A program will not start.	<p>If running a program with Microwave, the door is open.</p> <ul style="list-style-type: none"> ■ Check if the door is closed properly.
	<p>If running a program with Microwave, a microwave power level or cooking time have not been set.</p> <ul style="list-style-type: none"> ■ Be sure to set the power level and cooking time.
	<p>If running a Combi mode, all necessary setting have not been set.</p> <ul style="list-style-type: none"> ■ Be sure to set the microwave power level, temperature and cooking time.

Frequently asked questions

Problem	Possible cause and solution
System Lock  appears in the display when the oven is turned on.	<p>The system lock  is On.</p> <ul style="list-style-type: none"> ■ You can unlock the oven to start a cooking program by pressing  for at least 6 seconds. ■ To permanently deactivate the lock, see "Settings - System Lock .
The oven does not heat up.	<p>Demo mode is activated. The oven can be operated by will not heat up.</p> <ul style="list-style-type: none"> ■ Deactivate Demo mode (see "Settings - Showroom Program").
Power Failure - Program Canceled appears in the display.	<p>There has been a power failure which has caused the current cooking process to stop.</p> <ul style="list-style-type: none"> ■ Turn the oven off and then back on again. ■ Restart the cooking process.
12:00 appears in the display.	<p>The power supply was interrupted for longer than 200 hours.</p> <ul style="list-style-type: none"> ■ Reset the date and time.
Maximum operating duration reached appears in the display.	<p>The oven was operated for an unusually long period of time. The Safety cut-out feature has been activated.</p> <ul style="list-style-type: none"> ■ Confirm with OK. Clear the message Program Finished by selecting "Back". <p>The oven is now ready to use.</p>
 Fault XX appears in the display.	<p>A fault has occurred that you cannot resolve.</p> <ul style="list-style-type: none"> ■ Contact Miele Technical Service.
The core temperature cannot be set.	<p>The roast probe is not recognized by the oven.</p> <ul style="list-style-type: none"> ■ Check whether the roast probe is correctly plugged into the socket. <p>If the oven still does not recognize the roast probe, it must be faulty. A replacement roast probe can be ordered from Miele.</p>
If the door is opened while using Microwave (Solo) , the oven stops making a noise.	<p>This is not a fault. If Microwave (Solo)  is being used, the cooling fan will turn off when the door is opened.</p>

Frequently asked questions

Problem	Possible cause and solution
A noise is heard after the cooking process is complete.	The fan remains turned on after a cooking program (see "Settings - Cooling fan").
An strange sound is heard when the oven is operating in microwave mode.	<p>Metal was used in the oven during a program with microwave.</p> <ul style="list-style-type: none"> ■ Check if there are sparks caused by using metal dishes (see "Suitable containers for microwave use"). <p>When using a program with microwave the dish was covered with aluminum foil.</p> <ul style="list-style-type: none"> ■ If necessary, remove the cover. <p>The wire oven rack was used during a program with microwave.</p> <ul style="list-style-type: none"> ■ Always use the glass tray for programs with microwave.
The oven has turned itself off.	<p>The oven turns off automatically if a button is not pressed after a certain amount of time or after a cooking program has ended to save power.</p> <ul style="list-style-type: none"> ■ Turn the oven back on.
Baked goods are not cooked properly after following the times given in the chart.	<p>A different temperature than that given in the recipe was used.</p> <ul style="list-style-type: none"> ■ Select the temperature required for the recipe. <p>The ingredient quantities are different from those given in the recipe.</p> <ul style="list-style-type: none"> ■ Double check the recipe. The addition of more liquid or more eggs will make a wetter mixture which will take longer to cook.
The browning is uneven.	<p>The wrong temperature or shelf level was selected.</p> <ul style="list-style-type: none"> ■ There will always be a slight unevenness. If the unevenness is great, check whether the correct temperature and shelf level were selected. <p>The cookware used was not right for the program chosen. Bright, shiny pans are not very suitable. These reflect heat, which means that the heat does not penetrate to the food effectively, resulting in uneven or poor browning.</p> <ul style="list-style-type: none"> ■ Dark, matte pans are best for baking.

Frequently asked questions

Problem	Possible cause and solution
The food is not sufficiently heated or is not cooked at the end of a set duration when using Microwave (Solo)  .	<p>Check that the program was restarted after interrupting a cooking process using microwave power.</p> <ul style="list-style-type: none">■ Restart the program to ensure the food is heated or cooked properly. <p>When cooking for heating with microwave, the time set was too short.</p> <ul style="list-style-type: none">■ Check that the correct time is selected for the microwave power level. The lower the microwave power level the longer the cooking time.
The food has cooled down too quickly after being reheated or cooked in microwave mode.	<p>Due to the microwave properties, the heat is generated first at the edges of the food and is then transferred to the center of the food. If the food is heated with a high microwave power level the food may be hot on the outside but not heated through to the center.</p> <ul style="list-style-type: none">■ When cooking foods with different sizes, such as with menu cooking, a lower microwave power level for a longer period of time is most suitable.
The oven lighting turns off after a short time.	<p>The oven is factory set to turn off automatically after 15 seconds. This setting can be changed (see "Settings - Lighting").</p>

Frequently asked questions

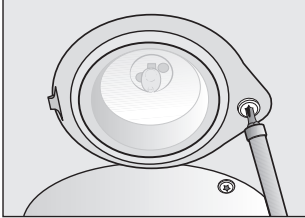
Problem	Possible cause and solution
<p data-bbox="76 202 365 260">The oven lighting does not turn on.</p> 	<p data-bbox="400 202 874 229">The halogen bulb needs to be replaced.</p> <div data-bbox="404 244 1039 368"><p data-bbox="418 256 665 292">⚠ Danger of burns!</p><p data-bbox="418 300 1020 357">Make sure the heating elements are turned off and allowed to cool completely.</p></div> <div data-bbox="404 384 1039 603"><p data-bbox="418 400 992 488">The light cover consists of two separate parts, a glass cover and mounting. If it falls it can be damaged.</p><p data-bbox="418 496 1001 584">When removing the cover hold it firmly so that it does not fall. Place a towel on the oven floor and open door to avoid damage.</p></div> <ul data-bbox="400 624 1023 1110" style="list-style-type: none"><li data-bbox="400 624 1023 651">■ Disconnect the appliance from the power supply.<li data-bbox="400 659 1023 716">■ Remove the screw to the lamp cover using a T20 Torx screwdriver, and take off the cover.<li data-bbox="400 724 1023 813">■ Do not touch the halogen bulb with bare fingers. Observe the manufacturers instructions. Remove the halogen bulb.<li data-bbox="400 821 1023 911">■ Replace it with a new halogen bulb (Osram 66725 AM/A, 230 V, 25 W, G9). It must be thermally stable up to 575°F (300°C).<li data-bbox="400 919 1023 1072">■ Replace the glass piece in the mounting, and refit the lamp cover. Make sure that the lug on the mounting is correctly located in the notch in the roof of the oven, then screw the mounting back into place.<li data-bbox="400 1080 1023 1110">■ Reconnect the oven to the electrical supply.

Technical Service

After sales service

In the event of a fault which you cannot easily correct yourself, please contact:

- your Miele dealer, or
- the Miele Technical Service Department.

See back cover for contact details.

Please quote the model and serial number of your appliance when contacting Miele.

This information is given on the data plate, visible on the front frame of the oven, with the door fully open.

Warranty

For further information, please refer to your warranty booklet.

Disposal of the packing material

The cardboard box and packing materials protect the appliance during shipping. They have been designed to be biodegradable and recyclable.

Ensure that any plastic wrappings, bags, etc. are disposed of safely and kept out of the reach of children.
Danger of suffocation!

Disposal of your old appliance

Do not dispose of this appliance with your household waste.

Old appliances may contain materials that can be recycled. Please contact your local recycling authority about the possibility of recycling these materials.

Before discarding an old appliance ensure that it presents no danger to children while being stored for disposal. Unplug it from the outlet, cut off its power cord and remove any doors to prevent hazards.

Electrical connection

CAUTION:

Before servicing, disconnect the power supply by either removing the fuse, shutting off the power main or manually "tripping" the circuit breaker.

Installation, repair and maintenance work must be performed by a Miele authorized service technician. Work by unqualified persons could be dangerous and may void the warranty.

Before connecting the appliance to the power supply, make sure that the voltage and frequency listed on the data plate correspond with the household electrical supply. This data must correspond to prevent machine damage. Consult an electrician if in doubt.

Only operate the appliance after it has been installed into cabinetry.

The plug must be plugged into an appropriate outlet that is installed and grounded in accordance with all local codes and ordinances.

The voltage can be adjusted (see "Settings - Electrical Version").

SAVE THESE INSTRUCTIONS FOR THE ELECTRICAL INSPECTOR'S USE.

WARNING: THIS APPLIANCE MUST BE GROUNDED

Installer: Please leave these instructions with the consumer.

Appliance and cut-out dimensions

Miele ovens can be installed flush or proud. Discuss your installation requirements with your architect, designer and installer.

Installation into a tall cabinet

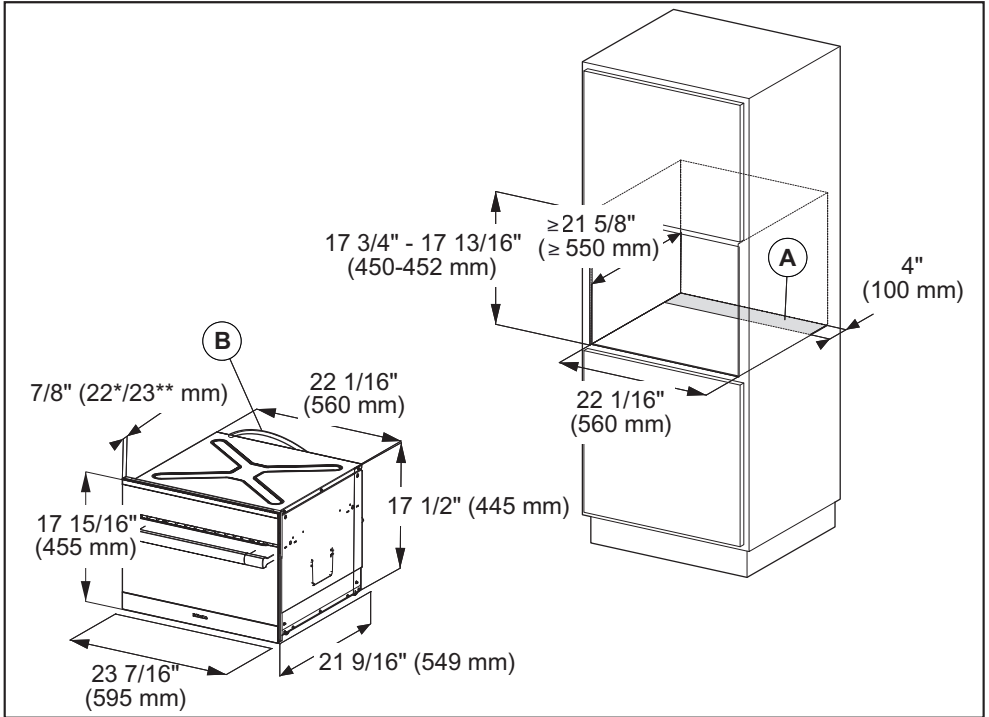

Ⓐ Cut-out (4" x 22" / 100 mm x 560 mm) in the bottom of the cabinet for power cord and ventilation

Ⓑ Power cord with plug

* Oven with glass front

** Oven with metal front

Front design may vary depending on model. For the more current specifications please visit the Miele website.

Installation diagrams

Undercounter installation

If installed underneath a cooktop, the installation instructions for the cooktop must also be taken into account.

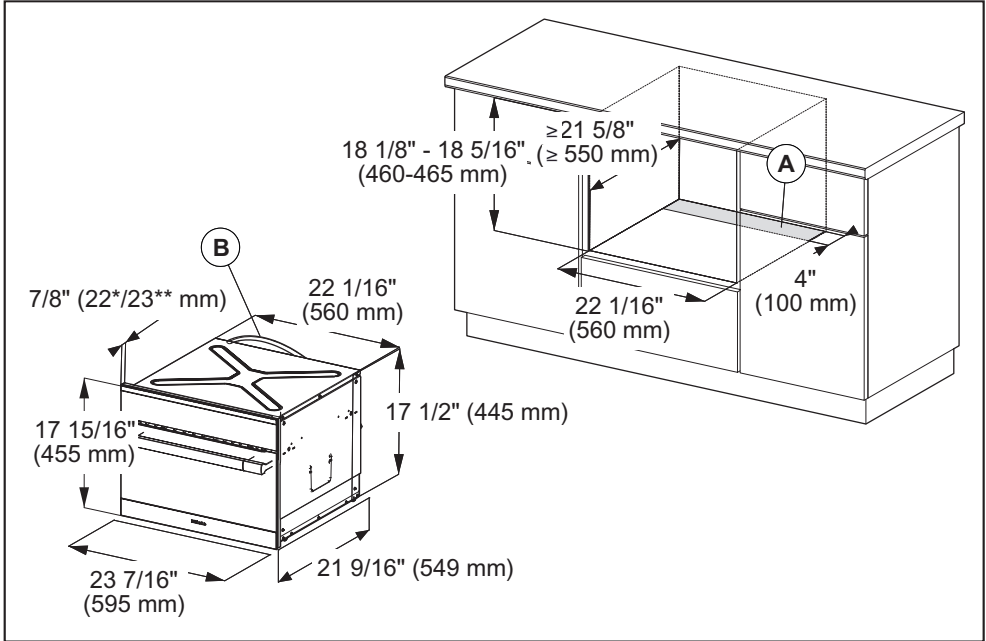

Ⓐ Cut-out (4" x 22" / 100 mm x 560 mm) in the bottom of the cabinet for power cord and ventilation

Ⓑ Power cord with plug

* Oven with glass front

** Oven with metal front

Front design may vary depending on model. For the more current specifications please visit the Miele website.

Installation in a tall cabinet in combination with an oven

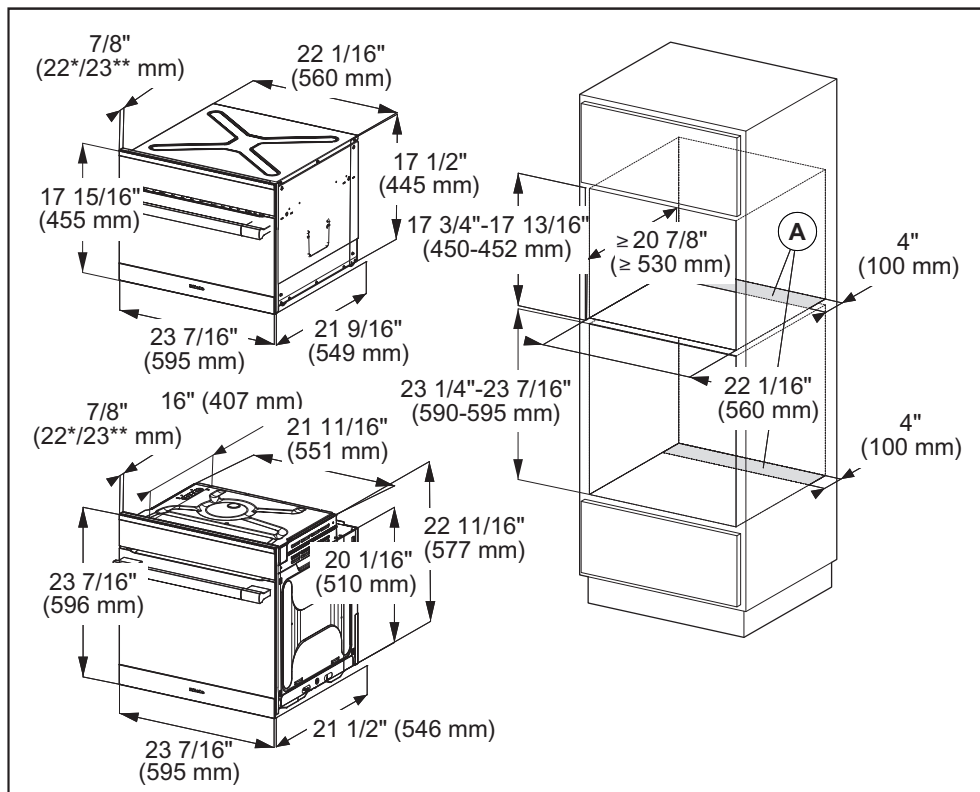

Ⓐ Cut-out (4" x 22" / 100 mm x 560 mm) in the bottom of the cabinet for power cord and ventilation

* Oven with glass front

** Oven with metal front

Front design may vary depending on model. For the more current specifications please visit the Miele website.

Installation diagrams

Front dimensions

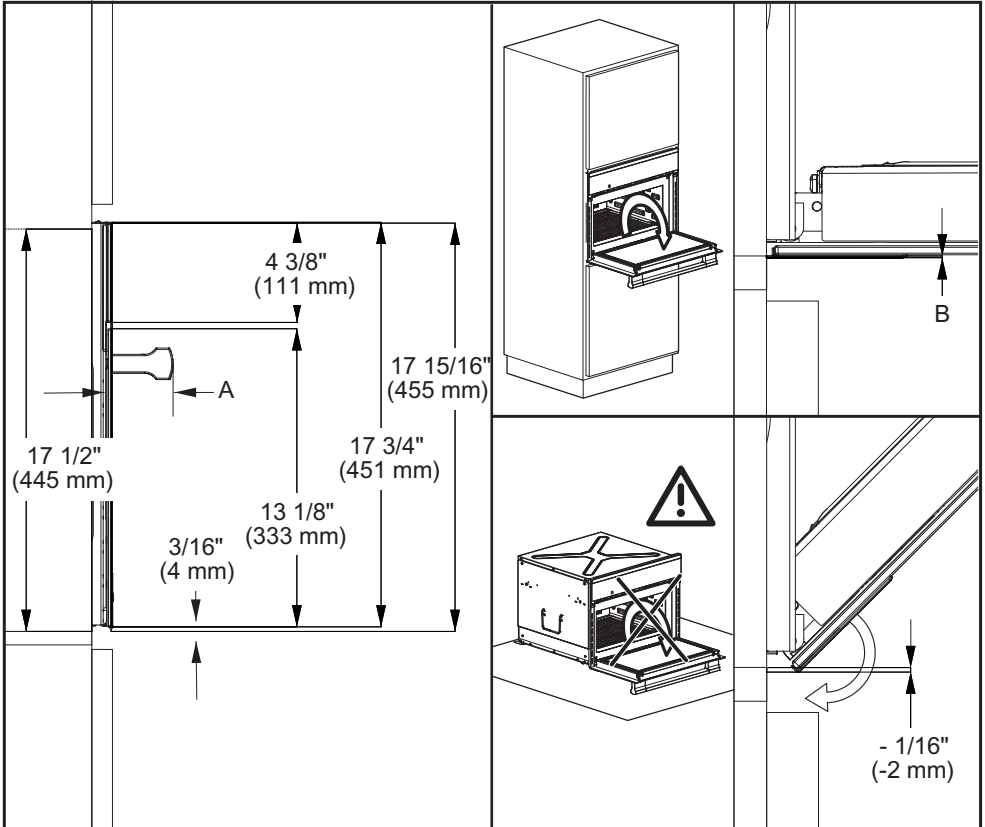

- A** H67xx: 2 3/4" (69 mm)
H68xx: 1 5/8" (42 mm)
- B** Speed Oven with glass front: 1/16" (2.2 mm)
Speed Oven with metal front: 1/16" (1.2 mm)

 The oven must not be operated until it has been properly installed within cabinetry.

Mounting the door handle (depending on model)

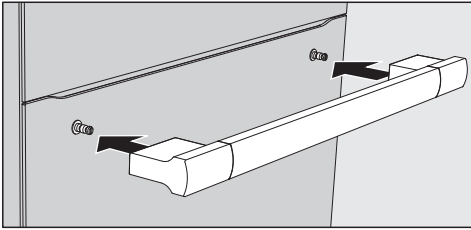

- Mount the handle onto the retaining bolts.

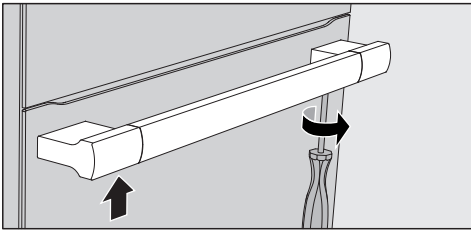

- Use the supplied Allen wrench to tighten all four bolts.

- If there are side handles, please remove them.
- Connect the power cord to the electrical supply.
- Push the oven into the cabinetry up to the oven trim and align it.

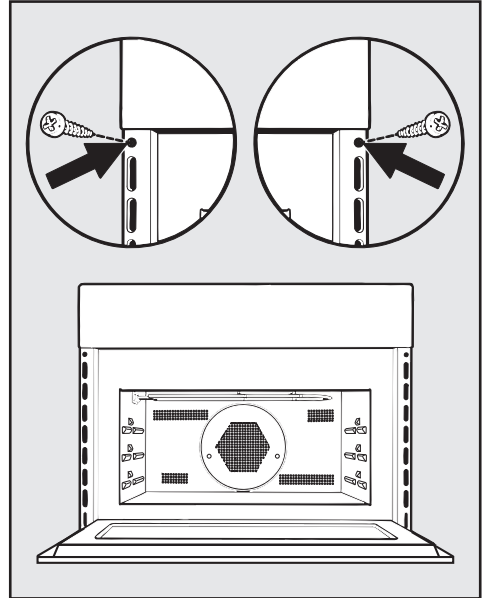

- Open the door and use the screws supplied to secure the oven to the side walls of the cabinetry through the holes in the oven trim.

Copyright and licenses

Miele uses software to operate and control the appliance.

The copyright authorisation from Miele and other relevant software suppliers (e.g. Adobe) must be respected.

Miele and their suppliers reserve the rights to the software components.

In particular the following are prohibited:

- copying and distribution,
- modifications and derivations,
- decompilation, reverse engineering, disassembling and other such reductions of software.

This product contains Adobe® Flash® Player Software under licence from Adobe Systems Incorporated, Adobe Macromedia Software LLC. Adobe and Flash are registered trademarks of Adobe Systems Incorporated.

Components which fall under GNU General Public Licence and further Open Source licenses are integrated into the software.

An overview of the integrated Open Source components and a copy of the current licence can be obtained at <http://www.miele.com/device-software-licenses>. You will need to enter the specific product name.

Miele will provide the source code for all components of software licensed under the GNU General Public License and comparable Open Source licenses.

For source code requests, please email info@miele.com.

Please have the model and serial number of your appliance available before contacting Technical Service.

Miele

U.S.A.

Miele, Inc.

National Headquarters

9 Independence Way
Princeton, NJ 08540

Phone: 800-843-7231
609-419-9898

Fax: 609-419-4298

www.mieleusa.com

Technical Service & Support

Nationwide

Phone: 800-999-1360

Fax: 888-586-8056

TechnicalService@mieleusa.com

Canada

Importer

Miele Limited

Headquarters and Miele Centre

161 Four Valley Drive
Vaughan, ON L4K 4V8

www.miele.ca

Customer Care Centre

Phone: 800-565-6435

905-532-2272

customercare@miele.ca

Germany

Manufacturer

Miele & Cie. KG
Carl-Miele-Straße 29
33332 Gütersloh



www.miele-shop.com

H6700BM; H6800BM



en – US, CA

M.-Nr. 09 786 930 / 02