



Owner's Manual

Dishwashers

GLDA690
GLDA696

Dishwashers

Safety Instructions..... 2-7

Operating Instructions

Care and Cleaning 13-14

Getting Started..... 8-9

Loading the Dishwasher..... 12

Using the Dishwasher 10-11

Troubleshooting Tips..... 15-17

Consumer Support

Consumer Support..... 20

Warranty19

Write the model and serial numbers here:

Model # _____

Serial # _____

You can find them on the tub wall, just inside the door.

IMPORTANT SAFETY INFORMATION

READ ALL INSTRUCTIONS BEFORE USING —

SAVE THESE INSTRUCTIONS

WARNING!

For your safety, the information in this manual must be followed to minimize the risk of fire, explosion, electric shock, and to prevent property damage, personal injury, or death.



WARNING! WATER HEATER SAFETY

Under certain conditions, hydrogen gas may be produced in a water heater that has not been used for two or more weeks. **HYDROGEN GAS IS EXPLOSIVE.**

If the hot water has not been used for two or more weeks, prevent the possibility of damage or injury by turning on all hot water faucets and allowing them to run for several minutes. Do this before using any electrical appliance connected to the hot water system. This simple procedure will allow any built-up hydrogen gas to escape. Since the gas is flammable, do not smoke, use an open flame, or use the appliance during this process.



WARNING! When using your dishwasher, follow basic precautions, including the following:

- Use this appliance only for its intended purpose as described in this Owner's Manual.
- Do not operate your dishwasher unless all enclosure panels are properly in place.
- Do not store or use combustible materials including gasoline or other flammable liquids or vapors in the vicinity of this or any other appliance.
- Do not abuse, sit on, or stand on the door or dish rack of the dishwasher.
- Do not tamper with controls.
- Do not wash plastic items unless marked dishwasher safe or the equivalent. For plastic items not so marked, check the manufacturer's recommendations.



WARNING! PROPER INSTALLATION AND MAINTENANCE

This dishwasher must be properly installed and located in accordance with the Installation Instructions before it is used. If you did not receive an Installation Instructions sheet with your dishwasher, you can receive one by visiting our Website at GEAppliances.com. In Canada, visit www.GEAppliances.ca.

- Connect the dishwasher/appliance to a grounded metal, permanent wiring system; or run an equipment-grounding conductor with the circuit conductors and connect to the equipment-grounding terminal or lead of the appliance.
 - Improper connection of the equipment-grounding conductor can result in a risk of electric shock. Check with a qualified electrician or service representative if you are in doubt whether the appliance is properly grounded.
 - Dispose of discarded appliances and shipping or packing material properly.
 - Do not attempt to repair or replace any part of your dishwasher unless it is specifically recommended in this manual. All other servicing should be referred to a qualified technician.
 - To minimize the possibility of electric shock, disconnect this appliance from the power supply before attempting any maintenance.
- NOTE:** Turning the dishwasher off does not disconnect the appliance from the power supply. We recommend having a qualified technician service your appliance.

CAUTION: ELECTRICAL REQUIREMENTS

- This appliance must be supplied with 120V, 60 Hz, and connected to an individual, properly grounded branch circuit protected by a 15 or 20 amp circuit breaker or time-delay fuse.
- If the electric supply provided does not meet the above specifications, it is recommended that a licensed electrician install an approved electrical connection.
- Your dishwasher circuit should not be used for any other appliance while the dishwasher is in operation as the dishwasher requires the full capacity of the circuit.
- If the wall receptacle you plug the dishwasher's power cord into is controlled by a switch, turn on the switch.

IMPORTANT SAFETY INFORMATION READ ALL INSTRUCTIONS BEFORE USING — SAVE THESE INSTRUCTIONS

GEAppliances.com

⚠ WARNING! RISK OF CHILD ENTRAPMENT

- Do not allow children to play with, on, or inside this appliance at any time.

PROPER DISPOSAL OF THE DISHWASHER

Junked or abandoned dishwashers are dangerous...even if they will sit for “just a few days.” If you are getting rid of your dishwasher, please follow the instructions below to help prevent accidents.

- Do not allow children to play with, on, or inside this or any discarded appliance.
- Take off the door of the washing compartment or remove the latch by removing the screw (on some models) from the latch receiver inside the tub (as shown).

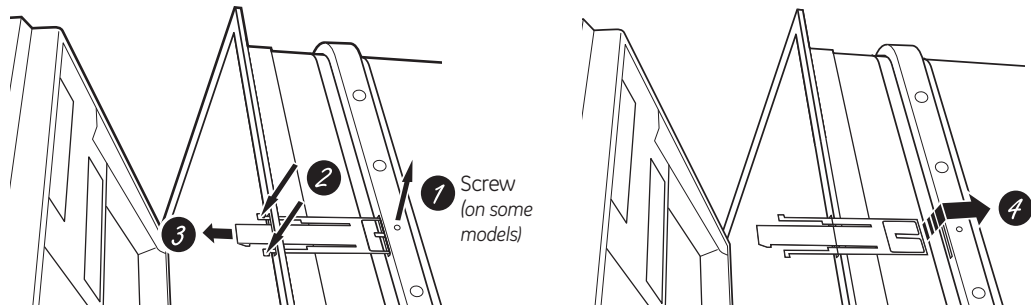

⚠ CAUTION: To prevent minor injury and property damage

- During or after wash cycle, contents may be hot to the touch. Use care before handling.
- Using a detergent that is not specifically designed for dishwashers will cause the dishwasher to fill with suds.
- Non-Dishware Items: Do not wash items such as electronic air cleaner filters, furnace filters and paint brushes in your dishwasher. Damage to the dishwasher and discoloration or staining of the dishwasher may result.
- Close supervision is necessary if this appliance is used by or near children. Do not allow children to play around the dishwasher when closing the door, closing the upper rack, or while vertically adjusting the upper rack due to the possibility of small fingers being pinched.
- Load light-weight, plastic items so they do not become dislodged and drop to the bottom of the dishwasher—they might come into contact with the heating element and be damaged.
- Locate sharp items so that they are not likely to damage the door seal.
- Load sharp knives with the handles up to reduce the risk of cut-type injuries.
- Do not touch the heating element during or immediately after use.

⚠ NOTICE

- If your dishwasher is connected to a wall switch, ensure that the switch is on prior to use.
- If you choose to turn the wall switch off between wash cycles, allow 5-10 seconds after turning the switch on before touching **START** to allow the control to initialize.
- Use only powder, **Cascade® Platinum Pacs**, liquid detergents or rinse agents recommended for use in a dishwasher and keep them out of the reach of children. **Cascade® Platinum Pacs** Automatic Dishwashing Detergent, and **Cascade® Complete Rinse Aid** rinse agents are recommended for use in all GE dishwashers.



READ AND FOLLOW THIS SAFETY INFORMATION CAREFULLY.

SAVE THESE INSTRUCTIONS

CONSIGNES DE SÉCURITÉ IMPORTANTES

VEUILLEZ LIRE TOUTES LES CONSIGNES AVANT D'UTILISER L'APPAREIL—CONSERVEZ CES DIRECTIVES

AVERTISSEMENT!

Pour votre sécurité, veuillez suivre les directives données dans le présent manuel afin de réduire au minimum les risques d'incendie, d'explosion et de chocs électriques et prévenir tout dommage et blessure grave ou mortelle.



AVERTISSEMENT! SÉCURITÉ DU CHAUFFE-EAU

Dans certaines conditions, il peut se former de l'hydrogène dans un chauffe-eau qui n'a pas été utilisé pendant deux semaines ou plus. **L'HYDROGÈNE EST UN GAZ EXPLOSIF.**

Si vous n'avez pas utilisé votre chauffe-eau pendant deux semaines ou plus, ouvrez tous les robinets d'eau chaude et laissez couler l'eau pendant plusieurs minutes afin de réduire les risques de dommages matériels ou de blessures. Prenez cette précaution avant même d'utiliser un électroménager raccordé au chauffe-eau pour éliminer l'hydrogène qui pourrait s'y être accumulé. Puisqu'il s'agit d'un gaz inflammable, ne fumez pas ou n'utilisez pas une flamme nue ou un électroménager au cours de ce processus.

AVERTISSEMENT! Lors du fonctionnement de votre lave-vaisselle, prenez les précautions de base, notamment les suivantes :



- N'utilisez cet appareil que pour l'usage pour lequel il a été conçu, comme expliqué dans le présent manuel.
- Ne faites pas fonctionner le lave-vaisselle si tous les panneaux de la carrosserie n'ont pas été correctement réinstallés.
- Ne rangez ni n'utilisez des matières combustibles, y compris de l'essence ou d'autres liquides ou vapeurs inflammables, à proximité de cet appareil ou de tout autre.
- Abstenez-vous de vous asseoir, de vous accrocher ou de vous tenir sur la porte ou le panier du lave-vaisselle, ou d'en faire un emploi abusif de toute autre manière.
- Ne modifiez pas le fonctionnement des commandes.
- Ne lavez pas les articles en plastique à moins qu'ils ne portent la mention « Lavable au lave-vaisselle » ou l'équivalent. Si certains articles en plastique ne portent pas cette mention, reportez-vous aux recommandations du fabricant.



AVERTISSEMENT! INSTALLATION ET ENTRETIEN APPROPRIÉS

Cet appareil doit être correctement installé, en conformité avec les directives d'installation fournies, avant d'être utilisé. Si vous n'avez pas reçu les directives d'installation avec votre appareil, vous pouvez vous les procurer en visitant notre site Web à l'adresse www.electromenagersge.ca.

- Cet appareil doit être relié à un système de câblage électrique permanent en métal, mis à la terre. Sinon, un fil de mise à la terre pour appareillage doit être installé et raccordé à la borne ou au fil de mise à la terre de l'appareil.
 - Un raccordement incorrect du fil de mise à la terre peut présenter un risque d'électrocution. Consultez un électricien ou un technicien qualifié si vous n'êtes pas certain que l'appareil est correctement mis à la terre.
 - Veuillez vous débarrasser de la façon appropriée de vos vieux électroménagers et des matériaux d'emballage ou d'expédition.
 - Ne tentez pas de réparer ou de remplacer une pièce quelconque de votre lave-vaisselle, à moins que cela ne soit spécifiquement recommandé dans le présent manuel. Confiez toutes les autres réparations à un technicien qualifié.
 - Pour réduire au minimum les risques d'électrocution, débranchez l'appareil de sa source d'alimentation avant d'en effectuer l'entretien.
- REMARQUE :** Le fait d'arrêter le lave-vaisselle ne coupe l'alimentation électrique de l'appareil. Nous vous recommandons de confier la réparation de votre électroménager à un technicien qualifié.

ATTENTION : EXIGENCES ÉLECTRIQUES

- Cet appareil électroménager doit être alimenté par du courant de 120V, 60 Hz, et branché à un circuit de dérivation bien mis à la terre, protégé par un fusible à retardement ou un disjoncteur de 15 ou 20 ampères.
- Si l'alimentation électrique fournie ne remplit pas les caractéristiques ci-dessus, nous vous recommandons de faire installer par un électricien qualifié une bonne prise.
- Le circuit de votre lave-vaisselle ne doit être utilisé par aucun autre appareil électroménager quand le lave-vaisselle fonctionne, car le lave-vaisselle nécessite toute la capacité du circuit.
- Si la prise murale dans laquelle vous branchez le cordon d'alimentation de votre lave-vaisselle est contrôlé par un interrupteur, mettez cet interrupteur en position ON (marche).

CONSIGNES DE SÉCURITÉ IMPORTANTES VEUILLEZ LIRE TOUTES LES CONSIGNES AVANT D'UTILISER L'APPAREIL—CONSERVEZ CES DIRECTIVES

GEAppliances.com

⚠ **AVERTISSEMENT! RISQUE DE SUFFOCATION POUR UN ENFANT COINCÉ À L'INTÉRIEUR DE L'APPAREIL**

- Ne laissez jamais les enfants jouer avec, sur, ou à l'intérieur de l'appareil.

ÉLIMINATION APPROPRIÉE DU LAVE-VAISSELLE

Les lave-vaisselle jetés ou abandonnés sont dangereux... même si vous ne les laissez là que pour quelques jours. Si vous voulez jeter votre lave-vaisselle, veuillez suivre les directives ci-dessous pour éviter les accidents.

- Ne laissez pas les enfants jouer avec, sur, le lave-vaisselle, ou à l'intérieur de celui-ci ou de tout autre électroménager mis aux rebus.
- Enlevez la porte du compartiment de lavage ou enlevez le verrou en ôtant les deux vis du loquet à l'intérieur de la cuve (comme illustré).

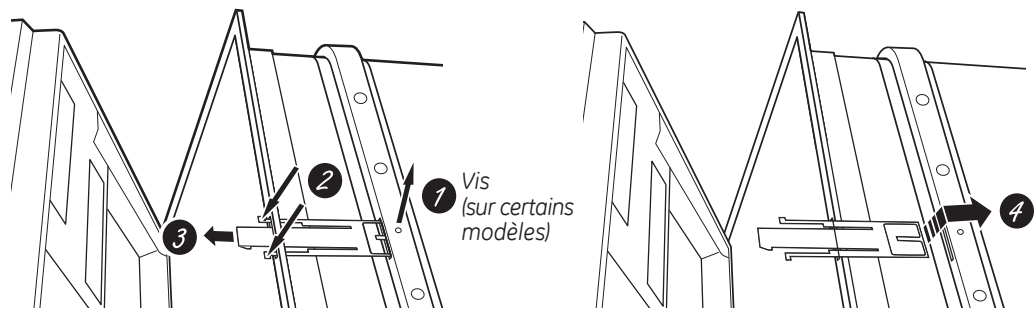

⚠ **ATTENTION : Pour éviter les blessures mineures ou les dommages matériels**

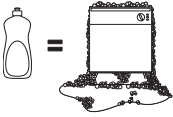
- Pendant ou après le cycle de lavage, le contenu peut s'avérer très chaud au toucher. Manipulez-le avec soin.
- L'utilisation d'un détergent non conçu pour les lave-vaisselles peut provoquer la formation de mousse. 
- Articles autres que la vaisselle : ne lavez pas dans le lave-vaisselle des articles comme des filtres de purificateur d'air, des filtres de systèmes de chauffage ou des pinces. Vous pourriez endommager le lave-vaisselle et provoquer une décoloration ou des taches dans l'appareil.
- Une surveillance attentive est nécessaire lorsque cet appareil est utilisé par ou près des enfants. Ne laissez pas les enfants jouer à proximité du lave-vaisselle lorsque vous la fermez, la fermeture de la porte, la fermeture de la crémaillère supérieure, ou tout réglage en hauteur du panier supérieur afin d'éviter que leurs petits doigts se coincent.
- Placez les articles légers en plastique de manière qu'ils ne se déplacent pas ou ne tombent pas au fond de l'appareil—they pourraient entrer en contact avec l'élément chauffant, ce qui pourrait les endommager.
- Placez les articles coupants de manière à ce qu'ils n'endommagent pas le joint d'étanchéité de la porte.
- Placez dans le panier à couverts les couteaux tranchants le manche vers le haut afin de réduire les risques de coupures.
- Ne touchez pas à l'élément chauffant pendant ou immédiatement après le fonctionnement de l'appareil.

⚠ **NOTICE**

- Si votre lave-vaisselle est branché sur un circuit relié à un interrupteur mural, assurez-vous d'actionner celui-ci avant d'utiliser votre appareil.
- Si vous fermez l'interrupteur mural entre les cycles de lavage, attendez de 5 à 10 secondes après avoir ramené l'interrupteur à **ON** (Marche) avant d'appuyer sur la touche **Start** (Marche) pour permettre aux commandes de se réinitialiser. 
- N'utilisez que les détergents et agents de rinçage liquides, en poudre ou en tablette ou les **Cascade® Platinum Pacs** recommandés pour les lave-vaisselle et gardez-les hors de la portée des enfants. Les détergents pour lave-vaisselle **Cascade® Platinum Pacs** et les agents de rinçage **Cascade® Complete Rinse Aid** sont recommandés avec les lave-vaisselle GE.



VEUILLEZ LIRE ET SUIVRE À LA LETTRE CES CONSIGNES DE SÉCURITÉ.

CONSERVEZ CES DIRECTIVES

INFORMACIÓN IMPORTANTE DE SEGURIDAD

LEA TODAS LAS INSTRUCCIONES ANTES DE USAR — GUARDE ESTAS INSTRUCCIONES

¡ADVERTENCIA!

Para su seguridad, siga las instrucciones de este manual a fin de minimizar riesgos de incendio, explosión, descargas eléctricas, y para evitar daños en su propiedad, lesiones personales o la muerte.

¡ADVERTENCIA! SEGURIDAD DEL CALENTADOR DE AGUA

Bajo ciertas condiciones, se podrá producir gas de hidrógeno en un calentador de agua que no fue usado por dos semanas o más. **EL GAS DE HIDRÓGENO ES UN EXPLOSIVO.**

Si el agua caliente no se usó durante dos semanas o más, evite la posibilidad de daño o lesión abriendo todos los grifos de agua caliente y permitiendo que el agua corra durante varios minutos. Haga esto antes de usar cualquier artefacto eléctrico que esté conectado al sistema de agua caliente. Este procedimiento simple permitirá el escape de cualquier gas de hidrógeno acumulado. Debido a que el gas es inflamable, no fume, no use una llama abierta ni use el electrodoméstico durante este proceso.



¡ADVERTENCIA! Al usar su lavavajillas, siga las precauciones básicas, incluyendo lo siguiente:

- Use este electrodoméstico sólo para su propósito original, como se describe en el Manual del Propietario.
- No use su lavavajillas a menos que todos los paneles de cercamiento estén correctamente en sus lugares.
- No guarde ni use materiales combustibles, incluyendo gasolina u otros líquidos o vapores inflamables cerca de éste o de otros electrodomésticos.
- No abuse, no se sienta, no se sostenga ni se pare sobre la puerta o la bandeja del plato del lavavajillas.
- No manipule indebidamente los controles.
- No lave productos de plástico, a menos que contengan una marca de seguridad en lavavajillas o su equivalente. Cuando se trate de productos de plástico que no estén marcados de esta manera, consulte las recomendaciones del fabricante.



¡ADVERTENCIA! INSTALACIÓN Y MANTENIMIENTO ADECUADOS

Esta lavadora se deberá instalar y ubicar de acuerdo con las Instrucciones de Instalación antes de ser usada. Si no recibió una ficha de Instrucciones de Instalación con su lavavajillas, podrá acceder a una visitando nuestro sitio web en GEAppliances.com.

- Conecte el lavavajillas/ electrodoméstico a un sistema de cableado de metal permanente con conexión a tierra o se debe tender un conducto para la conexión a tierra del equipo con los conductores del circuito y conectado al terminal de tierra del equipo o al conductor de suministro del electrodoméstico.
- Una conexión inapropiada del conductor de conexión a tierra del equipo puede provocar riesgos de descargas eléctricas. Consulte a un electricista calificado o personal del servicio técnico si tiene dudas de que el electrodoméstico se encuentre conectado a tierra apropiadamente.
- Deshágase de forma correcta de electrodomésticos y materiales de envío o embalajes descargados.
- No intente reparar o reemplazar ninguna parte de la cocina, a menos que se lo recomiende específicamente en este manual. Cualquier otra reparación deberá ser realizada por un técnico calificado.
- A fin de minimizar la posibilidad de descargas eléctricas, desconecte este electrodoméstico del suministro de corriente antes de intentar cualquier mantenimiento.
NOTA: Apagar el lavavajillas no desconecta el electrodoméstico del suministro de corriente. Le recomendamos que el servicio técnico de su electrodoméstico sea realizado por un técnico calificado.

PRECAUCIÓN: REQUISITOS ELÉCTRICOS

- Este electrodoméstico deberá ser provisto con 120V, 60 Hz, y estar conectado a un circuito individual correctamente conectado a tierra, protegido por un disyuntor o fusible de retardo de 15 o 20 amp.
- Si el suministro de corriente provisto no cumple con las especificaciones anteriores, se recomienda que un electricista matriculado instale un conexiones eléctricas aprobado.
- Su circuito del lavavajillas no debería ser usado para ningún otro electrodoméstico mientras el lavavajillas está funcionando, ya que éste requiere toda la capacidad del circuito.
- Si el receptáculo de pared en el cual enchufa el cable de corriente del lavavajillas es controlado por un interruptor, encienda este último.

INFORMACIÓN IMPORTANTE DE SEGURIDAD LEA TODAS LAS INSTRUCCIONES ANTES DE USAR — GUARDE ESTAS INSTRUCCIONES

GEAppliances.com

⚠ ¡ADVERTENCIA! RIESGO DE QUE UN NIÑO QUEDE ATRAPADO

- No permita que los niños jueguen con, en, o dentro de éste o cualquier electrodoméstico que haya descartado.

FORMA ADECUADA DE DESCARTAR EL LAVAVAJILLAS

Los lavavajillas tirados o abandonados son peligrosos...incluso aunque se conserven por “sólo unos pocos días”. Si se deshará de su lavavajilla, siga las siguientes instrucciones a fin de evitar accidentes.

- No permita que los niños jueguen con, en, o dentro de éste o cualquier electrodoméstico que haya descartado.
- Retire la puerta del compartimiento de lavado o quite la traba, retirando los dos tornillos del receptor de la traba dentro de la tina (como se muestra).

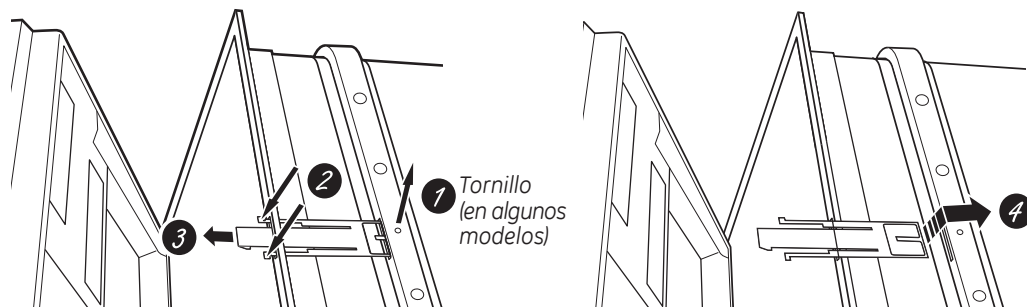

⚠ PRECAUCIÓN: A fin de evitar lesiones menores y daños sobre la propiedad

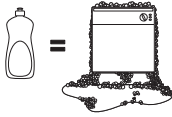
- Durante o después del ciclo de lavado, es posible que los contenidos estén calientes al tacto. Tenga cuidado antes de tomar los mismos.
- El uso de un detergente que no esté diseñado específicamente para lavavajillas hará que este último se llene de agua con jabón. 
- Productos que no sean utensilios: no lave artículos tales como filtros electrónicos de limpieza con aire, filtros de horno y brochas de pintura en su lavavajillas. Se podrán producir daños, descoloración o manchas sobre el lavavajillas.
- Se deberá estar especialmente atento si el electrodoméstico es usado por niños o se encuentra cerca de los mismos. No permita que los niños jueguen alrededor del lavavajillas cerrar la puerta, cerrar la bandeja superior, o mientras verticalmente ajustando la rejilla superior debido a la posibilidad de que sus dedos pequeños sean presionados.
- Cargue artículos de plástico livianos, de modo que no sean desplazados ni caigan al fondo del lavavajillas – es posible que entren en contacto con el calentador y sean dañados.
- Ubique artículos puntiagudos de modo que no haya posibilidades de daños sobre el sellador de la puertal.
- Cargue los cuchillos puntiagudos con los mangos hacia arriba, a fin de reducir el riesgo de lesiones por cortes.
- No toque el elemento de calefacción durante o inmediatamente después del uso.

⚠ AVISO

- Si el lavavajillas está conectado a un tomacorriente de pared, asegúrese de que el interruptor esté encendido antes del uso. 
- Si decide apagar el interruptor entre ciclos de lavado, espere entre 5 y 10 segundos luego de encender el interruptor antes de presionar Start (Iniciar) para permitir que el control se inicie.
- Use sólo polvo, **Cascade® Platinum Pacs**, detergentes líquidos o agentes de enjuague recomendados para uso con un lavavajillas y mantenga los mismos fuera del alcance de los niños. El Detergente para Lavavajillas Automáticos **Cascade® Platinum Pacs**, y los agentes de enjuagues **Cascade® Complete Rinse Aid** se recomiendan para su uso en todos los lavavajillas de GE.



LEA Y SIGA ESTA INFORMACIÓN DE SEGURIDAD CUIDADOSAMENTE.

GUARDE ESTAS INSTRUCCIONES

Getting started!

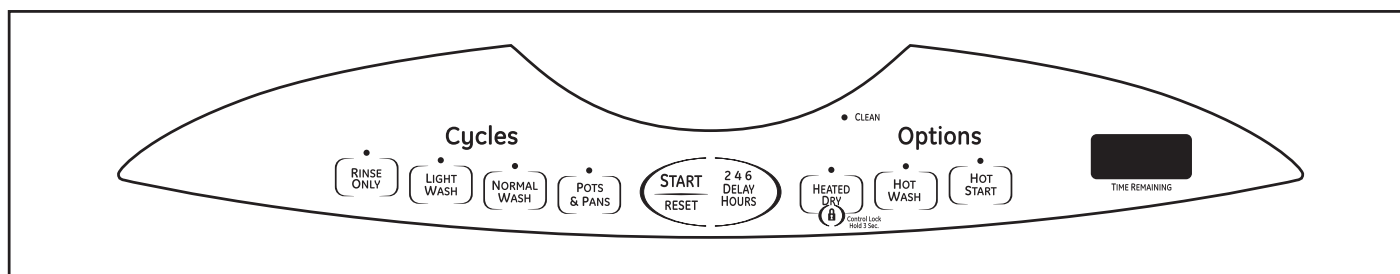

1 Load Dishwasher

For best dishwashing results, follow the loading guidelines found in the **Loading the dishwasher** section. No pre-rinsing of normal food soil is required. Scrape off hard soils, including bones, toothpicks, skins, and seeds. Remove leafy vegetables, meat trimmings, and excessive amounts of grease or oil.

2 Add Detergent

Add needed amount of detergent to the detergent dispenser. Use a detergent such as **Cascade® Platinum Pacs**. See **Detergent Dispenser** in the **Using the dishwasher** section.

3 Add Rinse Agent

Add rinse agent such as **Cascade® Complete Rinse Aid** to the rinse agent dispenser. See **Use a Rinse Agent** in the **Using the dishwasher** section.

4 Select Cycle

Close and latch the dishwasher door. The control panel lights will display the last settings selected. To change those settings, select the desired cycle.

POTS & PANS This cycle is meant for heavily soiled dishes or cookware with dried-on or baked-on soils. This cycle may not remove burned-on foods. Everyday dishes are safe to be used in this cycle. Time: 1 hour 25 minutes.

NORMAL WASH This cycle is for medium/heavily soiled dishes and glassware. Time: 1 hour 36 minutes.

LIGHT WASH This cycle is for lightly soiled dishes and glassware. Time: 33 minutes.

RINSE ONLY This cycle is for rinsing partial loads that will be washed later. **DO NOT** use detergent or **HEATED DRY** Option with this cycle. Time: 7 minutes.

5 Select Options

The light above the selected pad will be ON to indicate which Option has been selected.

HEATED DRY Light On	Turns the heater on for fast drying. This will extend the total cycle time by approximately 38 minutes for a NORMAL WASH cycle. NOTE: Cannot be selected with RINSE ONLY cycle.
HEATED DRY Light Off	Shuts off the drying heat option. Dishes will air dry naturally to save energy.
HOT WASH	When selected, the cycle will run a little longer with heating elements on to improve both wash and dry performance. Adds approximately 15 minutes to the cycle. NOTE: Cannot be selected with RINSE ONLY cycle.
HOT START	For use with heavily soiled and/or dried-on, baked-on soils. This Option MUST be selected PRIOR to starting the cycle. This option adds approximately 22 minutes to the cycle and two additional rinses to the cycle. NOTE: Cannot be selected with RINSE ONLY cycle.
LOCK 	You can lock the controls to prevent any selections from being made. Or you can lock the controls after you have started a cycle. Children cannot accidentally start dishwasher by touching pads with this Option selected. To unlock the dishwasher controls, press and hold the HEATED DRY pad for 3 seconds. The light above the lock pad will turn off. To lock the dishwasher controls, press and hold the HEATED DRY pad for 3 seconds. The light above the lock pad will turn on.
DELAY HOURS	You can delay the start of a wash cycle for up to 6 hours. Press the DELAY HOURS pad to choose the number of hours you want to delay the start of the cycle; then press START/RESET . The machine will count down and start automatically at the correct time. NOTE: To cancel the delay start selection before the cycle begins, repeatedly press the DELAY HOURS pad until the display is blank.

6 Start Dishwasher

START	The door must be closed to select the desired Options. Press the START/RESET pad to begin the cycle within 5 minutes of the door closure or begin the DELAY HOURS countdown. The illuminated lights will also turn off if more than 30 seconds passes between pressing a pad. To activate the display, open and close the door or press any pad.
Interrupt or Pause	To interrupt or pause a dish cycle, slowly open the door. Opening the door will cause the wash cycle to pause. The dishwasher will beep every minute to remind you to close the door. To restart or resume the cycle, press START , and close the door.
Cancel	To cancel a wash cycle, touch the START/RESET pad. The START/RESET light will flash while the water is pumped out, if needed. This takes approximately 2 minutes.

7 Indicator Light

CLEAN	The CLEAN light is illuminated when the selected cycle and enhancements are complete. The light will stay ON until a pad is pressed or the door is opened and then closed.
--------------	--

8 Display

Time Remaining	During operation, the display shows 1H if the time remaining is over an hour and will show the minutes remaining if the time remaining is below an hour. During a delay start, the display will show hours of time remaining until the cycle starts.
-----------------------	---

Using the dishwasher.



Check the Water Temperature

The entering water should be at least 120°F (49°C) and not more than 150°F (66°C) for effective cleaning and to prevent dish damage. Check the water temperature with a candy or meat thermometer.

Turn on the hot water faucet nearest the dishwasher, place the thermometer in a glass and let the water run continuously into the glass until the temperature stops rising.



Use a Rinse Agent

Rinse agents, such as **Cascade® Complete Rinse Aid** are designed for great drying action and to protect against spots and film build-up on your dishes, glasses, flatware, cookware, and plastic.

Filling the Dispenser

The rinse agent dispenser holds 3.5 oz. (104 ml) of rinse agent. Under normal conditions, this will last approximately one month.

- 1 Make sure the dishwasher door is fully open.
- 2 Turn the dispenser cap counterclockwise and lift out.
- 3 Slowly add rinse agent until the cup is full. You may need to pause several times to allow rinse aid to settle.
- 4 Clean up any spilled rinse agent with a damp cloth to prevent foam from forming inside the dishwasher.
- 5 Replace the dispenser cap.

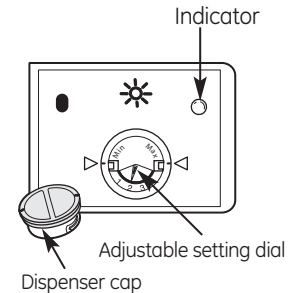

Rinse Aid Setting

The amount of rinse agent released into the final wash can be adjusted. The factory setting is at the midpoint. If water drops or hard water spots remain on dishes after the dry cycle, increase the setting.

To adjust the setting

Remove the dispenser cap;

Turn the adjuster counterclockwise to increase the amount of rinse agent, clockwise to reduce the amount of rinse agent.



Counterclockwise to reduce water drops and hard water spots



Clockwise to reduce foaming



Detergent Dispenser

The detergent dispenser has two compartments. To open, press the button and the cover will flip back. The pre-wash compartment is on the lid of the detergent dispenser. Use the pre-wash compartment only when your water is extremely hard or when you have a heavy soiled load. The pre-wash compartment is not used when tablet or packet detergents are used.

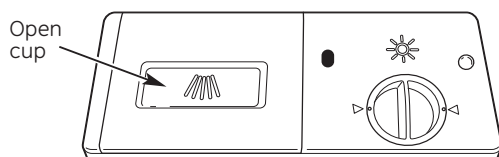

You may use tablet, packet, powder, liquid or gel automatic dishwasher detergent. Make sure you use only detergents specifically labeled for use in automatic dishwashers. Never use liquid hand dish detergent in an automatic dishwasher. Sudsing and poor wash performance will result with the use of improper detergents.

Detergents should be stored in a dry location and in their original container to prevent loss of effectiveness. Place detergent in the cup just prior to starting the dishwasher and then close the cover. The cover will open during the wash cycle.

Filling the Detergent Dispenser

GE recommends using detergent in tablet or packet form. Independent testing has shown this form of detergent is very effective in the dishwasher. **Cascade® Platinum Pacs** are an example of this type of detergent. Simply put a tablet or packet into the main wash compartment and close the detergent cup cover. Please notice that the tablet or packet must be placed in the main wash compartment of the detergent cup. If the tablet or packet is tossed in the bottom of the dishwasher, the detergent will be flushed down the drain in a very short period of time and will thus be wasted. Wash performance will be very poor as a result.

If you choose to use detergent in powder, liquid or gel form, the amount of detergent you use will be determined by the hardness of your water, the temperature of your water, and the food soil load inside the dishwasher. Contact your water company to get information about the hardness of the water in your area. Water hardness is measured in grains per gallon. Use this information and the table above to determine the amount of detergent to use. You may purchase a hard water test strip from GE. Call 1-877-959-8688 and ask for part number **WD01X10295**. In Canada, call 1-800-661-1616.

Number of Grains/Gal.	Detergent Cup(s) to Fill
Less than 4	15 cup
4 to 8	25 cup
8 to 12	15 and 25 cup
Greater than 12	15 and 25 cup and the open cup

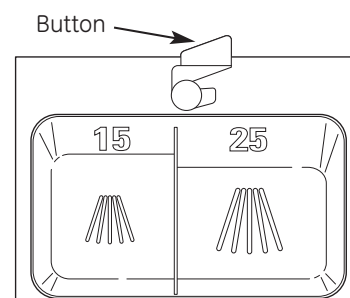

Using too much detergent with very soft and/or very hot water may cause a condition called etching on your glassware. Etching is a permanent cloudiness in your glassware. This condition is irreversible. However, using too little detergent will cause poor wash performance.

Use the table as a starting point and then adjust the amount of detergent you use. Use just enough to get good wash performance. Using just the right amount of detergent will provide great wash performance without wasting detergent or etching glassware.

DO NOT USE HAND DISH DETERGENT

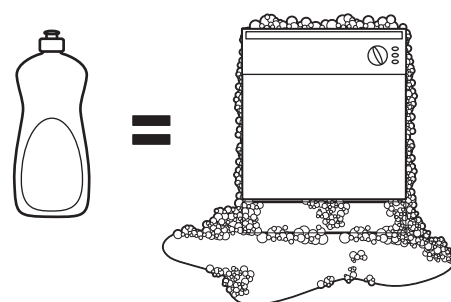

NOTE: Using a detergent that is not specifically designed for dishwashers will cause the dishwasher to fill with suds. During operation, these suds will spill out of the dishwasher vents, covering the kitchen floor and making the floor wet.

Because so many detergent containers look alike, store the dishwasher detergent in a separate space from all other cleaners. Show anyone who may use the dishwasher the correct detergent and where it is stored.

While there will be no lasting damage to the dishwasher, your dishes will not get clean using a dishwashing detergent that is not formulated for automatic dishwashers.

Loading the dishwasher.

For best dishwashing results, follow these loading guidelines.

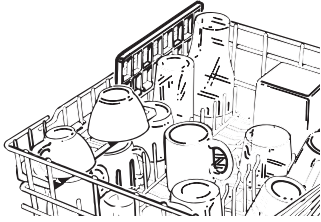

Upper Rack

Although the upper rack is for glasses, cups and saucers, pots and pans can be placed in this rack for effective cleaning. Cups and glasses fit best along the sides. This is also a secure place for dishwasher-safe plastics.

The upper rack is good for all kinds of odd-shaped utensils. Saucepans, mixing bowls and other items should be placed face down. Fold-down tines (on some models) provide flexibility for extra-large and hard-to-fit items.

Secure larger dishwasher-safe plastics over 2 tines when possible.

Make sure small plastic items are secure so they can't fall onto the heater.

Be sure that items do not protrude through the bottom of the rack and block rotation of the middle spray arm. This could result in poor wash performance for items in the upper rack.

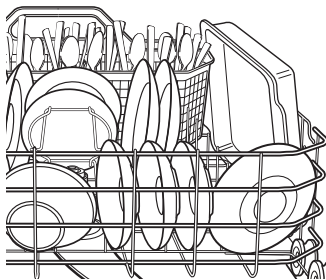

Lower Rack

The lower rack is best used for plates, saucers and cookware. Large items such as broiler pans and baking racks should go along the left-hand side. Load platters, pots and bowls along the sides, in corners or in the back. The soiled side of items should face the center of the rack. If necessary, oversized glasses and mugs can be placed in the lower rack to maximize loading flexibility.

Also, be careful not to let a portion of an item such as a pot or dish handle extend through the bottom rack. This could block the wash arm and cause poor washing results.

Fold-down tines (on some models) provide flexibility for extra-large and hard-to-fit items. The tines may be left in the up position or folded down to customize the lower rack.

Three-piece basket



Don't let any item extend through bottom.



To remove end baskets, grasp the basket at opposite corners and slide apart.

Silverware Basket

To load flatware, simply push the adjustable handle to either side. Put flatware in the removable basket with fork and knife handles up to protect your hands. Place spoons in the basket with handles down. Mix knives, forks and spoons so they don't nest together. Distribute evenly. Small plastic items, such as measuring spoons and lids from small containers should go in the bottom of the silverware basket with the silverware on top.

A variety of options is available regarding the three-piece silverware basket in your dishwasher. The complete basket is designed to fit on the right side of the lower rack. Additionally, each end of the basket is removable to add loading flexibility to accommodate flatware and lower rack capacity needs.

The lids of both end and middle baskets (on some models) can be closed to contain small items. Long items can be placed on the utility shelf in the upper rack.

Cleaning the Exterior Door Panel

Before cleaning the front panel, make sure you know what type of panel you have. Refer to the last two letters of your model number. You can locate your model number on the left-hand tub wall just inside the door. If your model number ends with BB, CC or WW then you have a painted door panel. If your model number ends with SS, then you have a Stainless Steel Door panel.

Follow the instructions below for cleaning the door panel for your specific model.

Painted Door Panel (model numbers ending in BB–black, CC–bisque or WW–white.

Use a clean, soft, lightly dampened cloth, then dry thoroughly.

Stainless Steel Door Panel (model numbers ending in SS)

The stainless steel panels can be cleaned with *Stainless Steel Magic* or a similar product using a clean, soft cloth. Do not use appliance wax, polish, bleach or products containing chlorine on Stainless Steel doors.

Do not use scouring pads or powder cleaners because these products can scratch the finish.

You can order *Stainless Steel Magic* #WX10X29 through GE Parts by calling 1.877.959.8688 or visiting **GEApplianceparts.com**. In Canada, call 1-800-661-1616.

Cleaning the Control Panel

To clean the control panel, use a lightly dampened cloth. Then dry thoroughly.

Cleaning the Dishwasher Interior

To clean and de-odorize your dishwasher, use citric acid or Lemi Shine®*, a detergent additive. Lemi Shine will break up mineral deposits, and remove hard water film and stains. You can order citric acid GE kit #WD35X151 through GE Parts by calling 877-959-8688 or visiting **GEApplianceparts.com**. In Canada, call 1-800-661-1616. You can purchase Lemi Shine at your local grocery store or by calling GE Parts at the numbers above and ask for WX10X10019.

Stainless Steel Inner Door and Tub

The stainless steel used to make the dishwasher tub and inner door provides the highest reliability available in a GE dishwasher.

If the dishwasher tub or inner door should be scratched or dented during normal use, they will not rust or corrode. These surface blemishes will not affect their function or durability.

* Lemi Shine® is a registered trademark of Envirocon Technologies, Inc.

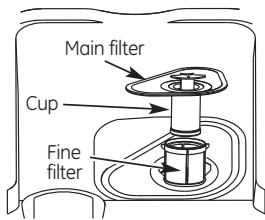

Cleaning the Filters

Inspect and clean the filters periodically. This should be done every month. If there is a decrease in wash performance or dishes feel gritty, this is also an indication the filters need to be cleaned.

To clean the filters, remove the bottom rack. Lift out the main filter and cup assembly. Lift out the fine filter.

Rinse the main filter, fine filter and cup with warm soapy water. Scouring pads or brushes can scratch the filter surface but a soft brush or sponge may be needed to remove stubborn soils or calcium deposits caused by hard water.

Once cleaned replace the fine filter followed by the cup and main filter assembly. Be sure to press them in place as improper replacement of the filter may reduce the performance level of the appliance.

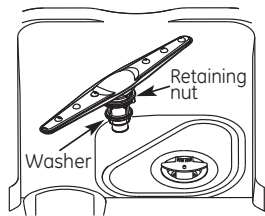

Cleaning the Spray Arms

Because hard water chemicals will clog the spray arm jets and bearings, it is necessary to clean the spray arms regularly. To remove the spray arm, twist the retaining nut 90 degrees and pull the spray arm off the shaft.

Wash the arms in soapy, warm water and use a soft brush to clean the jets. Replace them after rinsing thoroughly.

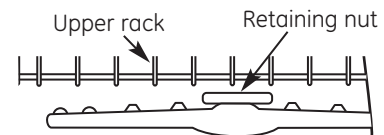

Protect Against Freezing

If your dishwasher is left in an unheated place during the winter, ask a service technician to:

- 1 Turn off electrical power to the dishwasher. Remove fuses or trip circuit breaker.
- 2 Turn off the water supply and disconnect the water inlet line from the water valve.

- 3 Drain water from the water inlet line and water valve. (Use a pan to catch the water.)

- 4 Reconnect the water inlet line to the water valve.



Check the air gap any time your dishwasher isn't draining well.

Does Your Dishwasher Have an Air Gap?

An air gap protects your dishwasher against water backing up into it if a drain clogs. The air gap is not a part of the dishwasher. It is not covered by your warranty. Not all plumbing codes require air gaps, so you may not have one.

The air gap is easy to clean.

- 1 Turn off the dishwasher and lift off the air gap cover.
- 2 Remove the plastic cap under the cover and clean with a toothpick.
- 3 Replace the cap and cover when the air gap is clean.



Troubleshooting Tips

Save time and money! Review the charts on the following pages, or visit GEAppliances.com. In Canada visit www.GEAppliances.ca. You may not need to call for service.

Problem	Possible Causes	What To Do
Dishes and flatware not clean	Main or Fine filter is clogged	<ul style="list-style-type: none"> See the Care and cleaning section.
	Low inlet water temperature	<ul style="list-style-type: none"> Make sure inlet water temperature is correct (see the Using the dishwasher section). Turn on the hot water faucet nearest the dishwasher, let run until the water temperature stops rising. Then start the dishwasher and turn off the faucet. This ensures the entering water is hot. Select HOT WASH.
	Water pressure is temporarily low	<ul style="list-style-type: none"> Turn on a faucet. Is water coming out more slowly than usual? If so, wait until pressure is normal before using your dishwasher.
	Air gap or disposer is clogged	<ul style="list-style-type: none"> Clean the air gap or flush the disposer.
	No high drain loop	<ul style="list-style-type: none"> Verify that you have a high drain loop. Refer to the Installation Instructions.
	Improper rack loading	<ul style="list-style-type: none"> Make sure large dishware does not block the detergent dispenser or the wash arms. See the Loading the dishwasher section.
Poor performing detergent	<ul style="list-style-type: none"> Use a highly rated detergent such as Cascade® Platinum Pacs. 	
Spots and filming on glasses and flatware	Extremely hard water	<ul style="list-style-type: none"> Use rinse agents such as Cascade® Complete Rinse Aid to prevent spots and prevent new film buildup. If water is extremely hard, a softener may be required.
	Low inlet water temperature	<ul style="list-style-type: none"> Make sure water temperature is at least 120°F (49°C).
	Overloading or improper loading of the dishwasher	<ul style="list-style-type: none"> Load dishwasher as shown in the Loading Place Settings section.
	Old or damp powder detergent	<ul style="list-style-type: none"> Make sure detergent is fresh.
	Rinse agent dispenser empty	<ul style="list-style-type: none"> Refill with rinse agent such as Cascade® Complete Rinse Aid.
	Too little or low performing detergent	<ul style="list-style-type: none"> Make sure you use the proper amount of highly rated detergent.

Before you call for service...

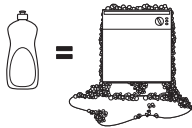
Problem	Possible Causes	What To Do
Cloudiness on glassware	Combination of soft water and too much detergent	<ul style="list-style-type: none"> This is called etching and is permanent. To prevent this from happening, use less detergent if you have soft water. Wash glassware in the shortest cycle that will get it clean.
	Low performing phosphate free detergent	<ul style="list-style-type: none"> See A white film on glassware, dishware and the interior in this Troubleshooting section.
	Water temperature entering the dishwasher exceeds 150°F (66°C)	<ul style="list-style-type: none"> This could be etching. Lower the water heater temperature.
Suds in the tub	Wrong detergent 	<ul style="list-style-type: none"> Use only automatic dishwasher detergents to avoid sudsing. Cascade® Automatic Dishwashing Detergents have been approved for use in all GE dishwashers. To remove suds from the tub, open the dishwasher and let suds dissipate. Close and latch the dishwasher. Pump out water by touching the START/RESET pad once; then 30 seconds later, touch the START/RESET pad again. Repeat if necessary.
	Rinse agent was spilled	<ul style="list-style-type: none"> Always wipe up rinse agent spills immediately.
Detergent left in dispenser cups	Dishes or utensils are blocking the detergent cup	<ul style="list-style-type: none"> Reposition the dishes, so the water from the lower spray arm can flush the detergent cup. See the Loading the dishwasher section. Reposition the tall utensils or heavy silverware that may be keeping the dispenser cup door from opening. See the Loading the dishwasher section. Don't place large bowls or pots directly under the detergent dispenser.
Black or gray marks on dishes	Aluminum utensils have rubbed against dishes	<ul style="list-style-type: none"> Remove marks with a mild, abrasive cleaner.
Dishes don't dry	Low inlet water temperature	<ul style="list-style-type: none"> Make sure inlet water temperature is at least 120°F. Select Heated Dry. Use HOT START, HOT WASH or ADDED HEAT options. Select a higher cycle, such as POTS & PANS.
	Rinse agent dispenser is empty	<ul style="list-style-type: none"> Check the rinse agent dispenser and fill as required.
Control panel responded to inputs but dishwasher never filled with water	Door may not be completely closed	<ul style="list-style-type: none"> Make sure the door is firmly closed.
	Water valve may be turned off	<ul style="list-style-type: none"> Make sure water valve (usually located under the sink) is turned on.
Stained tub interior	White film on inside surface—hard water minerals	<ul style="list-style-type: none"> GE recommends Cascade® Complete Rinse Aid to help prevent hard water mineral deposits from forming. Run dishwasher with citric acid to remove mineral deposits. Citric acid (Part number: WD35X151) can be ordered through GE Parts. See back cover for ordering information. Alternatively, purchase Lemi Shine (Part Number: WD10X10019) and follow the directions on the label.
Dishwasher won't run	Fuse is blown or circuit breaker is tripped	<ul style="list-style-type: none"> Replace fuse or reset circuit breaker. Remove any other appliances from the circuit.
	Power is turned off	<ul style="list-style-type: none"> In some installations, the power to the dishwasher is provided through a wall switch, often located next to the disposer switch. Make sure it is on.
	Control panel is locked	<ul style="list-style-type: none"> Unlock control panel. See the Getting started section.

Problem	Possible Causes	What To Do
Control panel lights go off when you're setting controls	Time too long between touching of selected pads	<ul style="list-style-type: none"> Each pad must be touched within 30 seconds of the others. To relight, touch any pad again, or unlock and relatch the door.
Water standing in the bottom of the tub	Air gap is clogged	<ul style="list-style-type: none"> Clean the air gap. See the Care and cleaning section.
	High drain loop or air gap not installed	<ul style="list-style-type: none"> Refer to the Installation Instructions for proper drain line installation.
Water won't pump out of the tub	Drain is clogged	<ul style="list-style-type: none"> If you have an air gap, clean it. See the Care and cleaning section. If the dishwasher drains into a disposer, run disposer clear. Check to see if your kitchen sink is draining well. If not, you may need a plumber.
Steam	This is normal	<ul style="list-style-type: none"> Warm, moist air comes through the vent during drying and when water is being pumped out. This is necessary for drying.
Sanitized light does not illuminate at the end of the cycle	The door was opened and the cycle was interrupted during or after the main wash	<ul style="list-style-type: none"> Do not interrupt the cycle by opening the door during the wash cycle.
	The incoming water temperature was too low	<ul style="list-style-type: none"> Raise the water heater temperature to between 120°F and 150°F.
Noise	Normal operating sounds: Detergent cup opening Water entering dishwasher The motor stops and starts at various times during the cycle Spray arms start and stop at various times Drain pump sounds during pump out	<ul style="list-style-type: none"> These are all normal. No action is required.
	Rattling dishes when the spray arm rotates	<ul style="list-style-type: none"> Make sure dishes are properly loaded. See the Loading the dishwasher section.
A white film on glassware, dishware and the interior	This problem is likely caused by a low quality phosphate-free dishwasher detergent	<ul style="list-style-type: none"> To remove the white film, run your dishes through a dishwasher cycle with citric acid. Use a WD35X151 citric acid kit found online. Otherwise, use Lemi Shine (WX10X10019) found at your local grocery store. Pour the citric acid in the detergent cup and close the cover. Place the filmed but otherwise clean glassware and dishware in the dishwasher. Leave silverware and other metal items out of the dishwasher. Turn the dishwasher on and let it run through a complete cycle without detergent. The glassware, dishware, and dishwasher should come out film free. Alternatively, a vinegar rinse may be used. Pour 1 cup of vinegar into dishwasher just after the detergent cup opens and let the dishwasher complete its cycle. This may be repeated several times a year as needed. The use of a rinse agent such as Cascade® Complete Rinse Aid may help minimize a repeat build up of film. Also, the use of a highly rated detergent such as Cascade® Platinum Pacs will help prevent film build-up.

Notes.

GE Dishwasher Warranty.

GEAppliances.com



All warranty service provided by our Factory Service Centers, or an authorized Customer Care® technician. To schedule service, visit us on-line at GEAppliances.com, or call 800.GE.CARES (800.432.2737) in the United States. In Canada, call 1.800.561.3344. Please have serial number and model number available when calling for service.

Staple your receipt here.
Proof of the original purchase date is needed to obtain service under the warranty.

Servicing your appliance may require the use of the onboard data port for diagnostics. This gives a GE Factory Service technician the ability to quickly diagnose any issues with your appliance and helps GE improve its products by providing GE with information on your appliance. If you do not want your appliance data to be sent to GE, please advise your technician NOT to submit the data to GE at the time of service.

For The Period Of: GE Will Replace:

One Year

From the date of the original purchase

Any part of the dishwasher which fails due to a defect in materials or workmanship. During this **limited one-year warranty**, GE will also provide, **free of charge**, all labor and in-home service to replace the defective part.

What GE Will Not Cover (for customers in the United States):

- Service trips to your home to teach you how to use the product.
- Improper installation, delivery or maintenance.
- Failure of the product if it is abused, misused, or used for other than the intended purpose or used commercially.
- Replacement of house fuses or resetting of circuit breakers.
- Product not accessible to provide required service.
- Damage to the product caused by accident, fire, floods or acts of God.
- Incidental or consequential damage caused by possible defects with this appliance.
- Cleaning or servicing of the air gap device in the drain line.
- Damage caused after delivery, including damage from items dropped on the door.

EXCLUSION OF IMPLIED WARRANTIES—Your sole and exclusive remedy is product repair as provided in this Limited Warranty. Any implied warranties, including the implied warranties of merchantability or fitness for a particular purpose, are limited to one year or the shortest period allowed by law.

This warranty is extended to the original purchaser and any succeeding owner for products purchased for home use within the USA. If the product is located in an area where service by a GE Authorized Servicer is not available, you may be responsible for a trip charge or you may be required to bring the product to an Authorized GE Service location for service. Proof of original purchase date is needed to obtain service under the warranty. In Alaska, the warranty excludes the cost of shipping or service calls to your home.

Some states do not allow the exclusion or limitation of incidental or consequential damages. This warranty gives you specific legal rights, and you may also have other rights which vary from state to state. To know what your legal rights are, consult your local or state consumer affairs office or your state's Attorney General.

Warrantor: General Electric Company, Louisville, KY 40225

What Is Not Covered (for customers in Canada):

- Service trips to your home to teach you how to use the product.
- Improper installation.
If you have an installation problem, contact your dealer or installer. You are responsible for providing adequate electrical, exhausting and other connecting facilities.
- Failure of the product if it is abused, misused, or used for other than the intended purpose or used commercially.
- Replacement of house fuses or resetting of circuit breakers.
- Damage to the product caused by accident, fire, floods or acts of God.
- Damage caused after delivery.

EXCLUSION OF IMPLIED WARRANTIES—Your sole and exclusive remedy is product repair as provided in this Limited Warranty. Any implied warranties, including the implied warranties of merchantability or fitness for a particular purpose, are limited to one year or the shortest period allowed by law.

This warranty is extended to the original purchaser and any succeeding owner for products purchased in Canada for home use within Canada. In home warranty service will be provided in areas where it is available and deemed reasonable by Mabe to provide.

WARRANTOR IS NOT RESPONSIBLE FOR CONSEQUENTIAL DAMAGES.

Warrantor: MC Commercial, Burlington, ON, L7R 5B6

Consumer Support.



GE Appliances Website

In the US: GEAppliances.com
In Canada: GEAppliances.ca

Have a question or need assistance with your appliance? Try the GE Appliances Website 24 hours a day, any day of the year! For greater convenience and faster service, you can now download Owner's Manuals, order parts or even schedule service on-line.



Schedule Service

In the US: GEAppliances.com
In Canada: GEAppliances.ca

Expert GE repair service is only one step away from your door. Get on-line and schedule your service at your convenience any day of the year! Or call 800.GE.CARES (800.432.2737) during normal business hours.

In Canada, call 800.561.3344



Real Life Design Studio

In the US: GEAppliances.com

GE supports the Universal Design concept—products, services and environments that can be used by people of all ages, sizes and capabilities. We recognize the need to design for a wide range of physical and mental abilities and impairments. For details of GE's Universal Design applications, including kitchen design ideas for people with disabilities, check out our Website today. For the hearing impaired, please call 800.TDD.GEAC (800.833.4322).

In Canada, please write to: Director, Consumer Relations, MC Commercial
1 Factory Lane, Suite 310
Moncton, N.B. E1C 9M3



Extended Warranties

In the US: GEAppliances.com
In Canada: GEAppliances.ca

Purchase a GE extended warranty and learn about special discounts that are available while your warranty is still in effect. You can purchase it on-line anytime, or call 800.626.2224 during normal business hours. GE Consumer Home Services will still be there after your warranty expires. In Canada, please consult your local listings for your extended warranty provider.

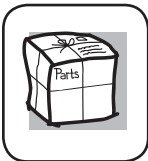

Parts and Accessories

In the US: GEAppliances.com

Individuals qualified to service their own appliances can have parts or accessories sent directly to their homes (VISA, MasterCard and Discover cards are accepted). Order on-line today, 24 hours every day or by phone at 877.959.8688 during normal business hours.

Instructions contained in this manual cover procedures to be performed by any user. Other servicing generally should be referred to qualified service personnel. Caution must be exercised, since improper servicing may cause unsafe operation.

In Canada, call 800.661.1616



Contact Us

In the US: GEAppliances.com
In Canada: GEAppliances.ca

If you are not satisfied with the service you receive from GE, contact us on our Website with all the details including your phone number, or write to: General Manager, Customer Relations

GE Appliances, Appliance Park
Louisville, KY 40225

In Canada, please write to: Director, Consumer Relations, MC Commercial
1 Factory Lane, Suite 310
Moncton, N.B. E1C 9M3



Register Your Appliance

In the US: GEAppliances.com
In Canada: GEAppliances.ca

Register your new appliance on-line—at your convenience! Timely product registration will allow for enhanced communication and prompt service under the terms of your warranty, should the need arise. You may also mail in the pre-printed registration card included in the packing material.