

Operating Instructions Dishwasher



To prevent accidents and machine damage, read these instructions before installation or use.

Contents

| | |
|--|----|
| IMPORTANT SAFETY INSTRUCTIONS | 5 |
| Notes on the operating instructions | 15 |
| Notes on the layout | 15 |
| Scope of delivery | 16 |
| Guide to the appliance | 17 |
| Appliance overview | 17 |
| Control field | 18 |
| Caring for the environment | 19 |
| Before using for the first time | 20 |
| Opening the door | 20 |
| Closing the door | 20 |
| Rinse aid | 21 |
| Adding rinse aid | 22 |
| Filling the rinse-aid reservoir | 22 |
| Caring for the environment | 24 |
| Energy-saving dishwashing | 24 |
| Loading the dishwasher | 25 |
| General information | 25 |
| Loading examples | 27 |
| Upper basket | 28 |
| Adjusting the upper basket | 30 |
| Lower basket | 31 |
| Cutlery tray | 31 |
| Loading the cutlery tray | 31 |
| Detergents | 32 |
| Active ingredients | 32 |
| Detergent dispensing | 33 |
| Adding detergent | 34 |
| Operation | 35 |
| Turning on the dishwasher | 35 |
| Selecting a program | 35 |
| Display of program duration | 36 |
| Starting a program | 36 |
| End of program | 37 |
| Energy management | 37 |
| Turning off the dishwasher | 38 |

| | |
|---|----|
| Unloading the dishwasher..... | 38 |
| Interrupting a program..... | 39 |
| Canceling or changing a program | 39 |
| Options | 40 |
| ⌚ Timer | 40 |
| Program overview | 42 |
| Program options | 44 |
| ⏱ Express..... | 44 |
| Audible signals | 45 |
| Turning off the refill reminders | 46 |
| Extra clean..... | 47 |
| Extra Dry..... | 48 |
| Factory defaults..... | 49 |
| Cleaning and care | 50 |
| Cleaning the wash cabinet | 50 |
| Cleaning the door and the door seal | 51 |
| Cleaning the control panel | 51 |
| Cleaning the front of the machine | 51 |
| Cleaning the spray arms..... | 52 |
| Checking the filters in the wash cabinet | 55 |
| Cleaning the filters..... | 55 |
| Cleaning the water-intake filter..... | 57 |
| Cleaning the drain pump | 58 |
| Frequently Asked Questions | 60 |
| Technical faults..... | 60 |
| Fault messages | 61 |
| Water intake fault..... | 62 |
| Water drainage fault | 63 |
| General dishwasher problems..... | 64 |
| Noises..... | 66 |
| Poor cleaning results..... | 67 |
| Customer Service | 70 |
| Contact in the event of a fault | 70 |
| Appliance warranty and product registration | 70 |
| Optional accessories | 71 |
| Installation | 73 |
| The Miele Waterproof System | 73 |

Contents

| | |
|-------------------------------------|-----------|
| Water intake | 73 |
| Water drainage | 75 |
| Electrical connection | 77 |
| Sound emission testing | 79 |

IMPORTANT SAFETY INSTRUCTIONS

This dishwasher complies with all current local and national safety requirements. Inappropriate use can, however, lead to personal injury and material damage.

Please observe the installation sheet and read the operating instructions carefully before setting up the dishwasher and using it for the first time. They both contain important information on the installation, safety, use, and maintenance of the machine. This prevents both personal injury and damage to the dishwasher.

Miele expressly and strongly advises that you read and follow the instructions in the section on installing the dishwasher as well as the **IMPORTANT SAFETY INSTRUCTIONS**.

Miele cannot be held liable for injury or damage caused by non-compliance with these instructions.

Keep the installation sheet and the operating instructions in a safe place and pass them on to any future owner.

IMPORTANT SAFETY INSTRUCTIONS

Appropriate use

- ▶ This dishwasher is intended for use in domestic households and similar residential environments.
- ▶ This dishwasher is not suitable for outdoor use.
- ▶ This dishwasher is intended for use at altitudes of up to 13,000 ft (4,000 m) above sea level.
- ▶ This dishwasher must only be used for cleaning domestic dishes and cutlery. All other types of use are not permitted.
- ▶ This appliance is not intended for use by persons (including children) with reduced physical, sensory or mental capabilities, or lack of experience and knowledge.

IMPORTANT SAFETY INSTRUCTIONS

Safety with children

- ▶ Children must be kept away from the dishwasher unless they are constantly supervised.
- ▶ Children may only use the dishwasher without supervision if they have been shown how to use it in a safe manner. Children must be able to understand and recognize the possible dangers caused by incorrect operation.
- ▶ Children must not be allowed to clean or maintain the appliance.
- ▶ Children should be supervised in the vicinity of the dishwasher. Never allow children to play with the dishwasher. There is a danger that children might shut themselves in the dishwasher.
- ▶ If the automatic door opening mechanism is active (depending on the model), keep young children away from the area in which the door opens.
- ▶ Danger of suffocation. While playing, children may become entangled in packaging material (such as plastic wrapping) or pull it over their head with the risk of suffocation. Keep packaging material away from children.
- ▶ Keep children away from detergents. Detergents cause severe skin burns and severe eye damage. They can cause burning in the mouth and throat, or inhibit breathing. It is therefore important to keep children away from the dishwasher when the door is open. Detergent residues could still be present in the machine. Seek medical advice immediately if a child has swallowed or inhaled any detergents.

IMPORTANT SAFETY INSTRUCTIONS

Technical safety

- ▶ Unauthorized installation, maintenance, and repairs can cause considerable danger for the user. Installation, maintenance, and repairs should only be carried out by a Miele authorized technician.
- ▶ Damage to the dishwasher can compromise your safety. Before using the dishwasher and in particular following transport, check it for any visible damage. Never use a damaged dishwasher.
- ▶ The electrical safety of the dishwasher can only be guaranteed when correctly grounded. It is most important that this basic safety requirement is fulfilled. If in doubt, the electrical installation should be checked by a qualified service technician.
Miele cannot be held liable for the consequences of an inadequate or lack of grounding system (e.g., electric shock).
- ▶ Temporary or permanent operation on an autonomous power supply system or a power supply system that is not synchronized with the grid power supply (e.g., island networks, back-up systems) is possible. A prerequisite for operation is that the power supply system complies with national and local codes.
The function and operation of the protective measures provided in the domestic electrical installation and in this Miele product must also be maintained in isolated operation or in operation that is not synchronized with the grid power supply, or these measures must be replaced by equivalent measures in the installation.
- ▶ Where the dishwasher is plugged into the electricity supply using a 3-pin plug with a grounding contact, the electrical socket must be easily accessible after the dishwasher is installed so that it can be disconnected from the electricity supply at any time.
- ▶ There must be no electrical sockets behind the dishwasher because the building-in niche may be too small. Danger of overheating and fire risk if the dishwasher were to be pushed up against a plug.

IMPORTANT SAFETY INSTRUCTIONS

▶ The dishwasher must not be installed underneath a cooktop. The high temperatures radiated by cooktops could damage the dishwasher below. For the same reason, the dishwasher must not be installed next to open fires or other appliances that give off heat, such as heaters etc., not normally found in a kitchen.

▶ Ensure that the connection data on the dishwasher's data plate (fuse rating, frequency, and voltage) match the electricity supply. This data must correspond in order to avoid the risk of damage to the dishwasher. Compare these before connecting the appliance to the electricity supply. If in any doubt, consult a qualified service technician.

▶ Do not connect the dishwasher to the electricity supply until it has been fully installed and any adjustment has been made to the door springs.

▶ The dishwasher may only be operated if the door opening mechanism is working correctly. Otherwise there could be a risk of danger while the automatic door opening mechanism (depending on the model) is active.

To check that the door opening mechanism is working correctly:

- The door springs must be evenly adjusted on both sides. They are correctly adjusted when the door remains stationary when left half open (approx. 45° opening angle). It is also important that the door cannot fall open.
- The door locking pins automatically retract when the door opens at the end of the drying phase.

▶ Power bars and extension cords do not guarantee the required safety of the appliance (risk of fire). Do not connect the dishwasher to the electricity supply using a power bar or an extension cord.

▶ The dishwasher must not be used in a non-stationary location (e.g., on a ship).

IMPORTANT SAFETY INSTRUCTIONS

- ▶ Do not install the dishwasher in a room where there is a risk of frost. Frozen hoses are at risk of tearing or bursting. The reliability of the electronic control unit may be impaired at temperatures below freezing point.
- ▶ To avoid any damage to the appliance, the dishwasher must only be operated when it is connected to a fully vented plumbing system.
- ▶ The plastic housing of the water connection contains an electrical valve. The housing must not be dipped in water.
- ▶ There are live wires in the water-intake hose. Do not shorten the hose, even if it is too long.
- ▶ The built-in Waterproof system offers reliable protection against water damage if the following conditions are met:
 - Installation has been carried out correctly.
 - The dishwasher is properly maintained and parts are replaced in case of noticeable damage.
 - The water-supply faucet is turned off during longer absences from the home (e.g., while on vacation).

The Waterproof system will work even when the dishwasher is turned off. However, the dishwasher must remain connected to the electricity supply.

- ▶ The water-connection pressure needs to be between 7.25 and 145 psi (50 and 1,000 kPa).
- ▶ A damaged dishwasher could be dangerous. If the dishwasher gets damaged, turn it off at the electricity supply immediately and contact your Miele dealer or Miele Customer Service.
- ▶ The manufacturer's warranty may be invalidated if the appliance is not repaired to Miele authorized service standards.
- ▶ We recommend replacing defective components with original parts. If original Miele parts are installed correctly, Miele ensures full compliance with safety requirements and the warranty remains valid.

IMPORTANT SAFETY INSTRUCTIONS

- ▶ During installation, maintenance, and repair work, the dishwasher must be disconnected from the electricity supply (turn it off and withdraw the plug from the socket).
- ▶ If the power cord is damaged, it must only be replaced with a specific cord of the same type (available from Miele Customer Service). For safety reasons, this must only be done by Miele Customer Service or a service technician authorized by Miele.

Correct installation

- ▶ The dishwasher must be installed and connected in compliance with the supplied installation sheet.



- ▶ Be careful before and while installing the dishwasher. Some metal parts pose a risk of injury/being cut. Wear protective gloves.

- ▶ The dishwasher must be correctly aligned horizontally to ensure problem-free operation.
- ▶ In order to ensure stability, built-under and integrated dishwashers must only be installed under a continuous countertop which is secured to adjacent cabinetry.
- ▶ The dishwasher must only be built into a tall cabinet if additional safety precautions are taken. In order to safely install the appliance in a tall cabinet, please use the tall cabinet installation kit and observe the installation sheet provided. Otherwise there is the danger of the cabinet tipping over.
- ▶ The door springs must be evenly adjusted on both sides. They are correctly adjusted when the door remains stationary when left half open (approx. 45° opening angle). It is also important that the door cannot fall open.

The appliance must only be operated with properly adjusted door springs.

If the door cannot be adjusted properly, contact the Miele Customer Service.

IMPORTANT SAFETY INSTRUCTIONS

The maximum weight of the front panel that can be aligned with the factory-installed door springs is 22-26.5 lb (10–12 kg) depending on model.

Correct use

- ▶ Do not use solvents in the dishwasher. There is a danger of explosion.
- ▶ Dishwasher detergents can cause burning on the skin and in the eyes, nose, mouth, and throat. Avoid contact with detergents. Do not inhale powder detergents. Do not swallow dishwasher detergents. Seek medical attention immediately if detergent has been swallowed or inhaled.
- ▶ Avoid leaving the dishwasher door open unnecessarily. You could injure yourself on the opened door or trip over it.
- ▶ Do not sit, stand, or lean on the opened door. The dishwasher could tip over. This could injure you or damage the dishwasher.
- ▶ Dishes may be very hot at the end of the program. Allow the dishes to cool until they are comfortable enough to handle before unloading them.
- ▶ Only use detergent and rinse aid formulated for domestic dishwashers. Do not use liquid dish soap.
- ▶ Do not use any commercial or industrial detergents. These may cause material damage, and there is a risk of a severe explosive chemical reaction (such as an explosive oxyhydrogen gas reaction).
- ▶ Do not fill the rinse aid reservoir with powder or liquid detergent. This will cause damage to the rinse aid reservoir.
- ▶ Do not fill the AutoDos (depending on model) with powder or liquid detergent. Loose detergent will damage the AutoDos.

IMPORTANT SAFETY INSTRUCTIONS

- ▶ In dishwashers with a cutlery basket (depending on model), knives and forks should be placed with the handles upwards in the basket for safety reasons. Knives and forks placed with the handles downwards pose a danger of injury. However, cutlery placed handle down in the cutlery basket will come out cleaner and drier.
- ▶ Plastic items which cannot withstand being washed in hot water, such as disposable plastic containers or plastic cutlery, should not be cleaned in the dishwasher. The high temperatures in the dishwasher may cause them to melt or lose shape.
- ▶ If you use the timer option (depending on model), the detergent compartment must be dry. Wipe dry with a cloth first if necessary. The detergent will clump together if the detergent compartment is not dry, and this may mean that it is not fully rinsed out.

Accessories and parts

- ▶ Only use original Miele accessories. If other parts are used, warranty, performance, and, if applicable, product liability claims will be invalidated.
- ▶ Miele will guarantee to supply functional spare parts for a minimum of 10 years and up to 15 years following the discontinuation of your dishwasher.

Transport

- ▶ Damage to the dishwasher can compromise your safety. Before using the dishwasher, check it for any visible transport damage. Never use a damaged dishwasher.
- ▶ Only transport the dishwasher in an upright position so that no water flows into the electrical controls, as this would cause faults.
- ▶ If you wish to transport the dishwasher, empty it and securely fasten all loose parts such as baskets, hoses, and power cords.

IMPORTANT SAFETY INSTRUCTIONS

Disposal of your old dishwasher

- ▶ Remove the door of the dishwasher so that children cannot become trapped inside.

California Proposition 65

WARNING

This product can expose you to chemicals mineral oils¹, Nickel (Metallic)¹, Diisononyl phthalate (DINP)¹ and Di-isodecyl phthalate (DIDP)², which are known to the State of California to cause ¹cancer and ²birth defects or ²other reproductive harm.

For more information go to www.P65Warnings.ca.gov.

Notes on the operating instructions

Notes on the layout

Warnings

 Warnings important for safety are highlighted like this. This alerts you to the potential danger of injury to people or damage to property. Read the warnings carefully and follow the instructions and directions.

Notes

Notes contain information that is particularly important to follow. They are highlighted in a thick framed box.

Additional information and comments

Additional information and comments are contained in a narrow frame.

Instructions for the user

Instructions on how to operate the dishwasher are identified by marked operating steps. They explain the procedure step by step.

Operating steps are indicated by a black square bullet point.

Example:

- Select the setting you want and press *OK* to confirm.

Scope of delivery

The following items are supplied:

- dishwasher
- operating instructions for operating the dishwasher
- installation sheet for installing the dishwasher
- other installation accessories for installing the dishwasher (see installation sheet)
- funnel for filling the reactivation salt (if available)
- additional printed matter and additions if required

Appliance overview

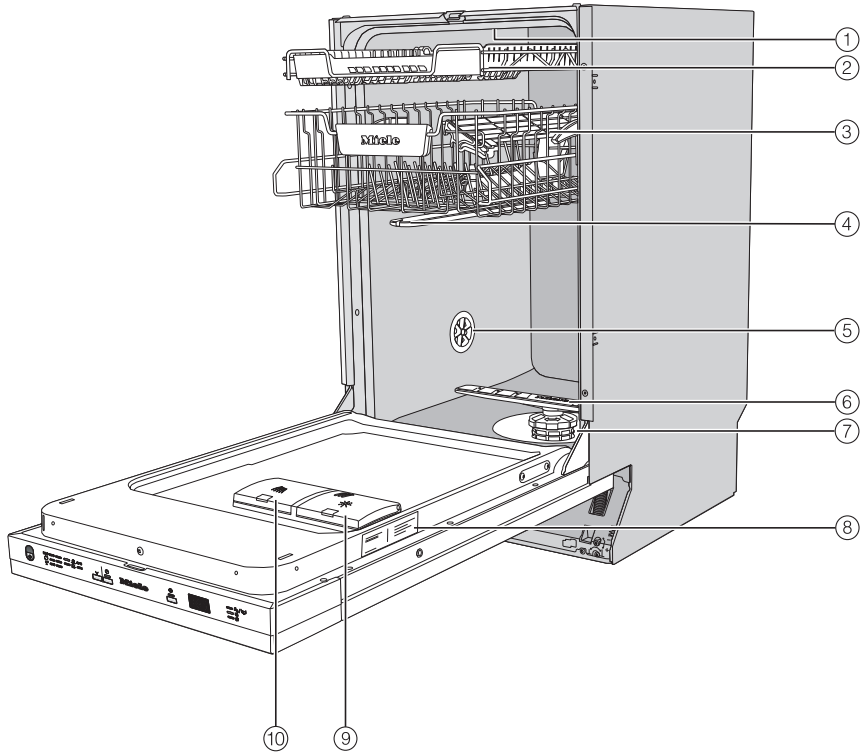

- | | |
|-------------------------------------|-------------------------|
| ① Top spray arm | ⑥ Bottom spray arm |
| ② Cutlery tray (depending on model) | ⑦ Filter combination |
| ③ Upper basket (depending on model) | ⑧ Data plate |
| ④ Middle spray arm | ⑨ Rinse aid reservoir |
| ⑤ Aeration valve | ⑩ Detergent compartment |

Guide to the appliance

Control field



① Program selection

- ☑ Normal = Normal
- 🍲 Pots = Pots & Pans
- ⌚ Quick = QuickIntenseWash
- 🚰 Sani = SaniWash
- 🌊 Rinse = Rinse & Hold

② Time display

③ Indicator lights/refill reminders

- 🚰 / 🗑️ = Intake/Drainage
- ☀️ = Rinse aid

④ ⌚ *Timer* button

For selecting a later program start.

⑤ ⌚ *Express* button

For reducing the program cycle time.

⑥ *Program* program selection button

For program selection.

⑦ ⏻ *On/Off* button

For turning the dishwasher on and off.

Disposal of the packing material

The cardboard box and packing materials protect the appliance during shipping. They have been designed to be biodegradable and recyclable.

Ensure that any plastic wrappings, bags, etc. are disposed of safely and kept out of the reach of children. Danger of suffocation!

Disposal of your old appliance

Electrical and electronic appliances contain valuable materials. They also contain certain substances, compounds and components which were essential for the proper functioning and safe use of the equipment. Handling these materials improperly by disposing of them in your household waste can be harmful to your health and the environment. Therefore, please do not dispose of your old appliance with regular household waste and follow local regulations on proper disposal.



Consult with local authorities, dealers or Miele in order to dispose of and recycle electrical and electronic appliances. Miele assumes no responsibility for deleting any personal data left on the appliance being disposed. Please ensure that your old appliance is kept away from children until removal. Observe safety requirements for appliances that may tip over or pose an entrapment hazard.

Before using for the first time

Every dishwasher is tested at the factory. There will be residual water in the machine from this test. It is not an indication that the dishwasher has been used previously.

Opening the door

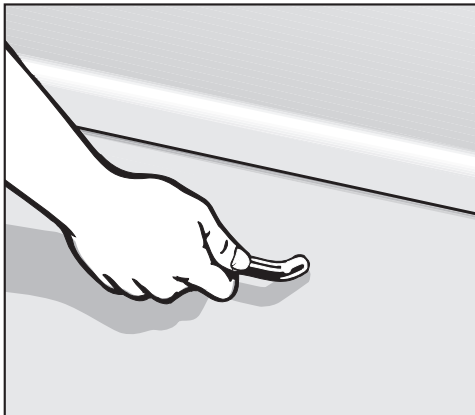

- Pull the handle to open the door.

If the door is opened during operation, all functions are automatically interrupted.

 Risk of scalding due to hot water.

During operation, water in the dishwasher may be very hot.

During operation, only open the door with extreme caution.

Closing the door

- Insert the baskets.
- Then lift the door upward and push until it clicks into position.

 Risk of crushing due to the door closing.

When closing the door, you are at risk of shutting your fingers in it.

Do not put your hand inside the door as it is closing.

Before using for the first time

Rinse aid

Rinse aid is necessary to ensure that water does not cling and leave marks on dishes during the drying phase, and helps dishes dry faster after they have been washed.

Rinse aid is poured into the reservoir and the amount set is dispensed automatically.

 Liquid dish soap or detergent can cause damage.

Liquid dish soap and detergent can damage the rinse-aid reservoir.

Only fill it with rinse aid formulated for domestic dishwashers.

Alternatively, you could use liquid citric acid at a concentration of up to 10%. The resulting rinsing and drying quality will not, however, be as good as when rinse aid is used.

 Risk of acid damage.

The dishwasher can be damaged by high concentrations of acid.

Under no circumstances should you use citric acid with a higher acid content.

If you only ever wish to use combination detergent products in your dishwasher, you do not need to add rinse aid.

However, for optimum rinsing and drying results, use dishwasher detergent and add rinse aid separately.

Please make sure that if you stop using combination detergents, you refill the rinse aid. Turn the refill reminder back on if required.

Before using for the first time

Adding rinse aid

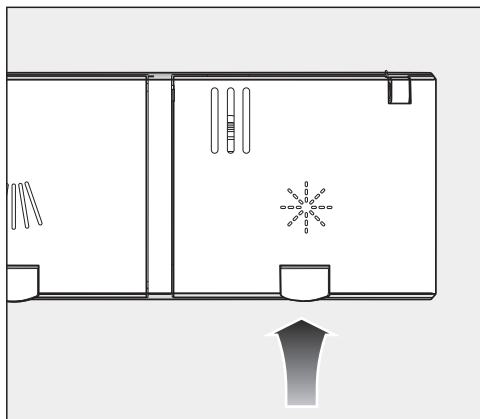

- Press the yellow button  on the lid of the rinse-aid reservoir.

The lid will spring open.

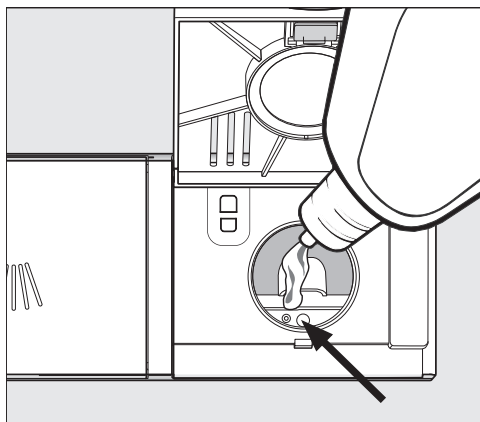

- Fill with rinse aid until the filling level indicator (arrow) changes to a dark color while the door is horizontally open.

The rinse-aid reservoir holds approximately 110 ml.

- Close the lid firmly until you hear it click into place. Otherwise, water can enter the rinse-aid reservoir during a program.
- Wipe up any spilled rinse aid. This prevents excess foam developing during the next program.

Filling the rinse-aid reservoir

When the refill reminder  *Rinse aid* appears in the display, the reservoir contains sufficient rinse aid for 2 to 3 programs only.

- Add rinse aid in plenty of time.

The rinse-aid refill reminder will go out.

If you only ever use combination detergent products containing rinse aid in your dishwasher, you can turn off the refill reminder if you wish (see “Turning off the refill reminders” under “Options”).

Before using for the first time

Setting the rinse-aid dosage

You can adjust the rinse-aid dosage for best results.

The rinse-aid dosage can be set from 0 to 6 ml.

3 ml is the factory default setting.





The rinse-aid dosage can turn out to be higher than the set value due to the automatic adjustment of the program.

If spots appear on dishes and glassware:

- Increase the rinse-aid dosage.

If clouding or smearing appears on dishes and glassware:

- Decrease the rinse-aid dosage.

- Open the door.
- Turn the dishwasher off with the  button, if it is turned on.
- Press the  button in and, **while holding it in**, turn the dishwasher on using the  button. Keep the  button pressed in for at least 4 seconds until the  indicator light comes on.

If this does not happen, start the procedure from the beginning again.

- Press the *Program* button 3 times.

The top left program indicator light will flash rapidly 3 times at intervals.

The set value will appear in the display after *P*.

P 3 will start flashing in the time display. Setting 3 is set.

- Use the  button to select the required setting. The dosage amount increases each time you press the button. When the highest value is reached, the setting starts again from the beginning.

The setting is now saved.

- Turn the dishwasher off with the  button.

Caring for the environment

Energy-saving dishwashing

This dishwasher is exceptionally economical in its use of water and electricity.

You can make the most of your machine by following these tips:

- Washing in a dishwasher generally uses less water and energy than washing by hand.
- There is no need to pre-rinse items under running water, and this unnecessarily increases water and energy consumption.
- Make full use of the basket capacity without overloading the dishwasher. This results in the most economical dishwashing in terms of energy and water consumption.
- Choose a program that best suits the degree of soiling and the type of dishes being washed (see “Program overview”).
- Select the *Normal* program for energy-saving dishwashing. This program is the most efficient in terms of its combined energy and water consumption for cleaning dishware with a normal level of soiling.
- Follow the detergent manufacturer’s recommendations on detergent dosage.
- When using powder or liquid detergent, you can use $\frac{1}{3}$ less detergent if baskets are only half full.

- You can connect the dishwasher to a hot-water supply. A hot water connection is particularly suitable with energy-saving water heating sources, such as solar energy with a circulation system.

If the water is heated by electricity, we would recommend connection to cold water.

General information

Remove coarse food residues from dishes.

There is no need to pre-rinse items under running water.

 Damage can be caused by ash, sand, wax, lubricating grease, or paint.

These substances will contaminate the dishwasher and can then no longer be removed.

Do not wash items soiled with these substances in the dishwasher.

Dishes can be loaded anywhere in the baskets, but the following notes should be observed:

- Do not place dishes and utensils inside other items where they will cover one another.
- Load the dishes so that water can access all surfaces. This ensures that they get properly cleaned.
- Make sure that all items are securely positioned.
- Hollow items such as cups, glasses, pans, etc., must be inverted in the baskets.
- Tall, narrow, hollow items such as champagne glasses should be placed in the center of the basket rather than in the corners. This ensures the hollow items are more easily accessed by the water jets.
- Concave items such as mugs or bowls should be placed at an angle so that the water can run off.

- The spray arms must not be blocked by items which are too tall or hang through the baskets. Test for free movement by manually rotating the spray arms.
- Make sure that small items cannot fall through the holders in the baskets. Small items such as lids should therefore be placed in the cutlery tray.

Some foods such as carrots, tomatoes, or ketchup may contain natural dyes. These dyes can discolor plastic items in the dishwasher if large quantities of these foods are in contact with the dishes inside the appliance. The stability of plastic items is not affected by this discoloration. Washing silverware can also cause plastic items to discolor.

Loading the dishwasher

Wash items not suitable for dishwashers:

- Wooden cutlery and dishes or items with wooden parts. These may discolor and fade. The glue used in these items is not dishwasher-proof and wooden handles may come loose after being washed in a dishwasher.
- Craft items, antiques, valuable vases, and decorative glassware. Such items are not suitable for dishwashers.
- Plastic items that are not heat resistant. The high temperatures in the dishwasher may cause them to melt or lose shape.
- Copper, brass, tin and aluminum items. These may discolor or become dull.
- Colors painted over a glaze. These may fade after a number of washes.
- Delicate glassware and glassware containing lead crystal. Clouding may occur over time.

Silver

Silver that has been in contact with foods containing sulphur can discolor. These include egg yolk, onions, mayonnaise, mustard, fish, and marinades.

Silverware previously cleaned with a **silver polish** may still be damp or spotted at the end of a program, where water has not run off smoothly.

Tip: Rub the silver dry with a cloth.

 Damage due to caustic alkaline detergents.

Aluminum parts (e.g., the grease filters of ventilation hoods) can be damaged by caustic alkaline detergents. In extreme cases, there is a risk of an explosive chemical reaction (such as an explosive oxyhydrogen gas reaction).

Aluminum components must not be cleaned in the dishwasher with caustic alkaline commercial or industrial detergents.

Tip: When purchasing new dishes and cutlery, make sure they are dishwasher-proof if you want to wash them in the dishwasher.

Glass care

- Clouding may occur on glasses after frequent washing in the dishwasher. When washing delicate glassware in the dishwasher, ensure that only a special glass-care program with very low temperatures is selected (see “Program overview”). This will reduce the risk of clouding.
- Purchase glassware that is dishwasher-safe (e.g., Riedel glassware).
- Use detergents with glass protective additives.

Loading the dishwasher

Loading examples

Loading for 10 standard place settings with cutlery tray

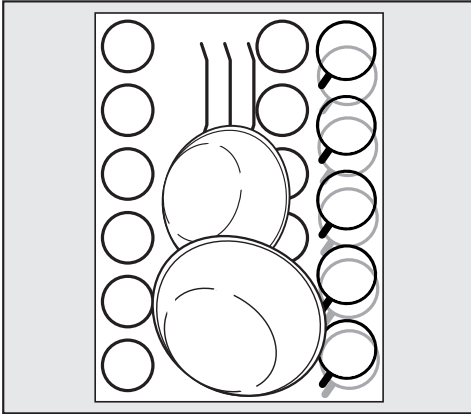

Upper basket

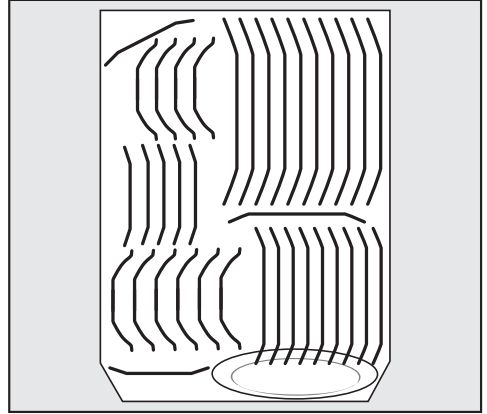

Lower basket

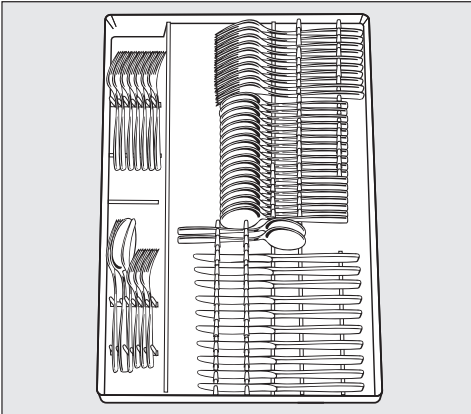

Cutlery tray

Loading the dishwasher

Upper basket

See “Loading examples” under “Loading the dishwasher” for examples of how to load dishware and utensils.

Loading the upper basket

 Risk of damage due to water leakage.

If you run the dishwasher without the upper basket, water can leak out of the dishwasher.

Only run the dishwasher with the upper basket in place (except during the Tall items program, if available).

- Use the upper basket for small, light-weight, and delicate items such as cups, saucers, glasses, dessert bowls, etc.
Shallow pans or casserole dishes can also be placed in the upper basket.
- Long items such as soup ladles and mixing spoons should be placed lying down across the front of the upper basket.

Loading the FlexCare cup rack

You can put cups, small bowls, and flat dishes on the FlexCare cup rack. Glasses can be arranged along the cup rack so they sit securely during the program.

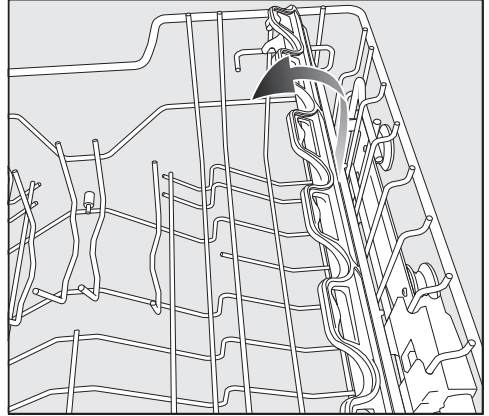

- Lower the cup rack to do so.
- Raise the cup rack upward to make room for tall items.

Adjusting the FlexCare cup rack

You can set the height and depth of the cup rack at 2 different levels so that it can accommodate larger cups and so that taller items can be placed underneath it.

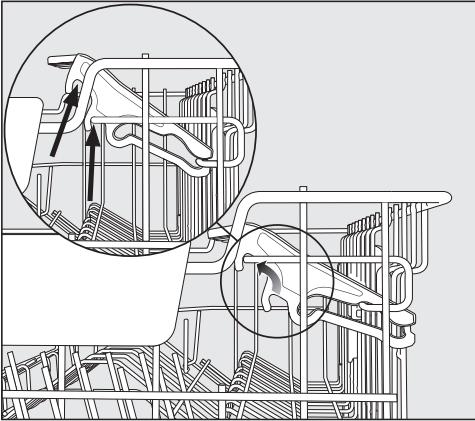

- Pull the cup rack upward and click it into the desired position (see arrows).

Loading the dishwasher

Adjusting the upper basket

In order to gain more space for taller items in the lower basket or upper basket, the upper basket can be adjusted on 3 levels with 3/4" (2 cm) between each level.

The upper basket can also be set at an angle so that water can run off freely from recesses. Make sure, however, that the basket can slide smoothly in and out of the wash cabinet.

- Pull out the upper basket.

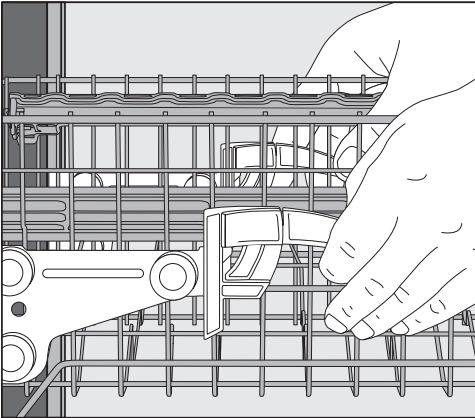

To raise the upper basket:

- Lift the basket until it clicks into place.

To lower the upper basket:

- Pull upwards on the levers at either side of the upper basket.
- Adjust the basket to the desired height and then push the levers securely back down into position.

When adjusting the upper basket, make sure that tall plates in the lower basket do not block the middle spray arm.

Loading the dishwasher

Lower basket

See “Loading examples” under “Loading the dishwasher” for examples of how to load dishware and utensils.

Loading the lower basket

- Place larger and heavier items such as plates, serving platters, saucepans, bowls, etc., in the lower basket.
Glasses, cups, and small plates and saucers can also be placed in the lower basket.

Cutlery tray

See “Loading examples” under “Loading the dishwasher” for examples of how to load dishware and utensils.

- Arrange the utensils in the tray as shown.

Loading the cutlery tray

To make unloading easier, utensils should be grouped in zones, one for knives, one for forks, one for spoons, etc.

Spoon heads should be placed in contact with at least one of the serrated retainers on the base of the cutlery tray to ensure that water runs off them freely.

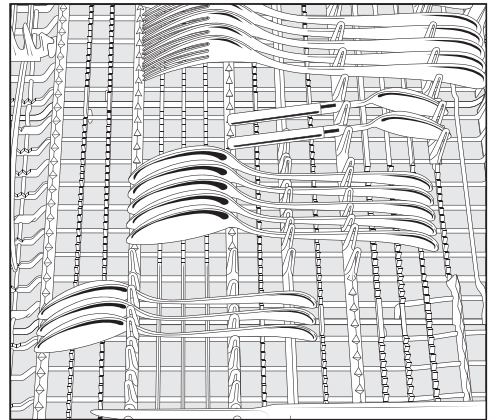

- If spoon handles do not fit between the holders, then lay them the other way round.

Arrange tall items (such as cake server) so that they do not block the upper spray arm.

Detergents

Active ingredients

 Damage caused by using unsuitable detergents.

Detergents that are not suitable for domestic dishwashers can cause damage to the dishwasher or to the wash items.

Only use detergents formulated for domestic dishwashers.

Modern detergents contain various active ingredients, the most important of which are:

- Water softening complexing agents to prevent calcification.
- Alkalis to aid removal of dried-on soiling.
- Enzymes to break down starch and loosen protein.
- Oxygen-based bleaching agents to remove colored stains (e.g., tea, coffee, tomato sauce).

Most dishwasher detergents are mildly alkaline and contain enzymes and oxygen-based bleaching agents.

There are different types of detergent:

- Powder and liquid gel detergents. These detergents allow you to adjust the amount dispensed according to the amount of wash items and the level of soiling.
- Tab detergents. These are suitable for most levels of soiling.

As well as the usual detergents, combination products are also available.

These contain rinse aid and water softener (reactivation salt).

Only use these combination detergents for the water hardness levels recommended by the manufacturer on the packaging.

The cleaning and drying performance of these combination detergents can vary greatly.

For optimum cleaning and drying results, use dishwasher detergent and add salt and rinse aid separately (depending on model).

 Risk of chemical burns from detergent.

Dishwasher detergents can cause burning on the skin and in the eyes, nose, mouth, and throat.

Avoid contact with detergents.

Do not inhale or ingest powder detergents. Do not swallow dishwasher detergents. Seek medical attention immediately if detergent has been swallowed or inhaled.

Keep children away from detergents. Detergent residues could still be present in the machine. Keep children away from the dishwasher when the door is open. Do not fill the detergent dispenser until just before starting the program and activate the door safety lock (depending on model).

Detergent dispensing

The detergent compartment holds a maximum of 3 1/2" tablespoons.

There are marks in the detergent compartment to aid with dispensing: 1 1/4, 2 tablespoons (20, 30 ml). When the door is opened to a horizontal position, they show the approximate fill level in ml and the maximum fill height.

- Follow the detergent dosage recommended by the manufacturer on the packaging.
- Unless directed otherwise, use one detergent tab or add 1 1/4 to 2 tablespoons (20 to 30 ml) of detergent to the detergent compartment, depending on the level of soiling of the dishware.

If you use less than the recommended amount of detergent, the dishware may not get properly clean.

Some tabs may not dissolve completely when the program *QuickIntenseWash* is used.

Detergents

Adding detergent

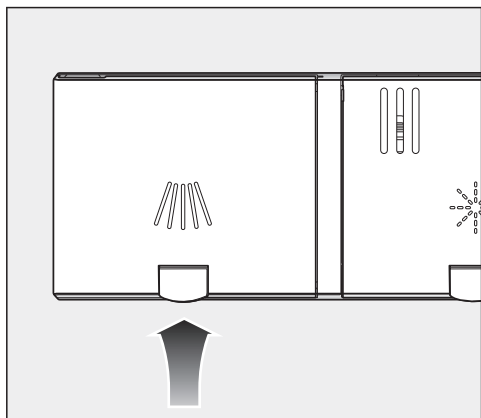

- Press the yellow button  on the lid of the detergent compartment.

The lid will spring open.
The lid will also open at the end of a program.

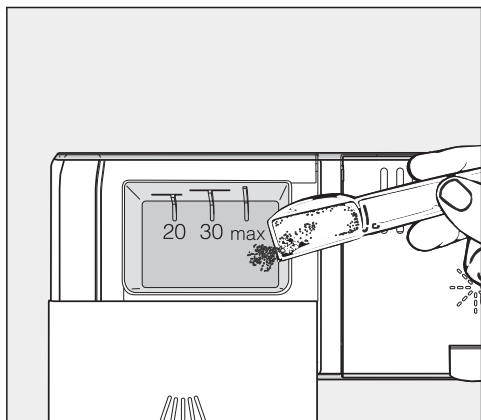

- Add the detergent to the detergent compartment.
- Push the lid shut until you hear it click into place.

The detergent must not cause the detergent-compartment lid to get stuck. This can prevent the lid from opening during the program.
Do not overfill the detergent compartment.

- Ensure that the detergent packaging is properly closed after use. This prevents the detergent from getting damp and clumping together.

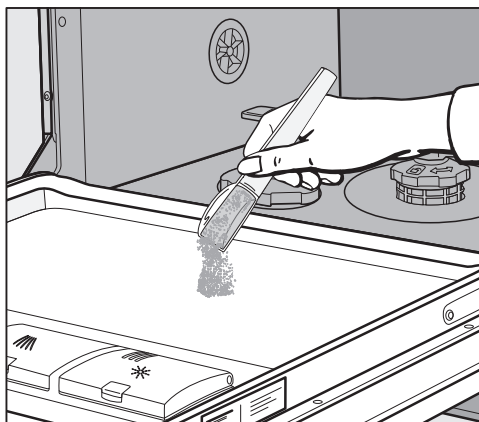

- You can also apply a small amount of detergent to the inner panel of the door in programs that have a pre-wash stage (see “Program overview”).

Turning on the dishwasher

- Turn on the water supply if it is turned off.
- Open the door.
- Make sure the spray arms can rotate freely.
- Press the  button.

The indicator light next to the program selected will come on.

Selecting a program

Choose your program according to the type of load and the degree of soiling.

The different programs and their uses are described under **Program overview**.

- Use the *Program* button to select the program you want.

The indicator light next to the program selected will come on.

The program duration will appear in hours and minutes in the display.

You can now select program options (see “Options”).

If any program options are selected, the appropriate indicator lights will also light up.

Operation

Display of program duration

The duration of the program selected appears in hours and minutes in the display before the program begins. If the door is opened during the program, the time left until the end of the program is displayed.

The displayed duration may vary for the same program. It is influenced by, for example, the temperature of the incoming water, the reactivation cycle of the water softener, the detergent type, the amount of dishware, and how soiled it is.

When a program is selected for the first time, the display will show the average program duration for a cold water connection.

The program durations shown under “Program overview” refer to standard test loads and temperatures.

Each time a program is run, the control module calculates the program duration required depending on the temperature of the water taken into the dishwasher and the amount of dishware.

Starting a program

- Start the program by closing the door.



Risk of scalding due to hot water.

During operation, water in the dishwasher may be very hot.

During operation, only open the door with extreme caution.

End of program

The audible signal might sound at the end of the program.

The program has ended when 0:00 shows in the display.

The drying fan may continue to run for a few minutes at the end of the program.



Risk of damage due to steam.

Steam from the dishwasher could damage the edges of delicate countertops when you open the door at the end of the program if the fan is no longer running.

At the end of a program, you can either open the door fully (do not leave it partially open) or leave it closed until you are ready to unload the dishes.

Energy management

To save energy, the dishwasher will switch off automatically 10 minutes after the last time a button is pressed or after the end of a program.

You can turn the dishwasher back on again with the  button.

The dishwasher will not turn itself off while a program is running or if there is a fault.

Operation

Turning off the dishwasher

- Open the door.
- The dishwasher can be turned off at any time using the  button.

Turning the dishwasher off during a program stops the program.

You can also do this to stop an ongoing timer.



Risk of damage from leaking water.

Leaking water can cause damage. If the dishwasher is not going to be used for a longer period of time, e.g., during vacations, the water shut-off valve should be turned off.

Unloading the dishwasher

Dishes tend to break and chip more easily when they are hot. Allow the dishes to cool until they are comfortable enough to handle before unloading them.

The dishes will cool much faster if you open the door when the program has ended.

- First unload the lower basket, then the upper basket and finally the cutlery tray. This will prevent water drops from the upper basket and cutlery tray from falling onto the dishes in the lower basket.

Interrupting a program

A program will be interrupted as soon as the door is opened.

After 4 seconds, the indicator light of the selected program and the time display will flash.

- Press the *Program* button and close the door within 4 seconds.

The program will continue from the point at which it was interrupted.



Risk of scalding due to hot water.

During operation, water in the dishwasher may be very hot.

During operation, only open the door with extreme caution.

Canceling or changing a program

If a program is canceled, important program stages may be missed.

A program should only be canceled in the first few minutes.

If a program has already started and you wish to cancel it, proceed as follows:

- Open the door.
- Turn the dishwasher off with the  button.

If you would like to select another program:

- Turn the dishwasher on again with the  button.
- If you have dispensed detergent manually, check whether the detergent compartment is still closed. If the lid is already open, fill it with detergent again and close the lid.
- Select the program you want, and then start it by shutting the door.

Options

Timer

You can set the start time of a program. The program start time can be delayed for between 30 minutes and 24 hours. With start-time delays between 30 minutes and 3 hours, the delay can be set in 30 minute stages. It is set in hours for periods longer than this.



During manual detergent dispensing, the detergent will clump together if the detergent compartment is not dry, and this may mean it is not fully rinsed out.

When using the timer function, make sure that the detergent compartment is dry before adding detergent. Wipe dry with a cloth first, if necessary. Do not use any liquid detergents. These can leak out.

 Danger to health due to detergent.



To prevent children coming into contact with dishwasher detergent:
Do not fill the detergent dispenser **until just before starting the program**, i.e., before you activate the timer.

Activating the timer

- Open the door.
- Turn the dishwasher on with the  button.
- Select the program you want to use.
- Press the  *Timer* button.

The most recently set time will be shown on the time display. The  *Timer* indicator light will light up.

- Set the required time after which the program should start automatically using the  button.

If the  button is pressed and held, the time will increase automatically up to 24 hours. To start again with 0:30 hours, press the  button twice.

- Close the door.

After you have activated the timer, all the displays will turn off after a few minutes to save energy.

Press the  button to switch the time display back on again for a few minutes.

- Open the door if you need to check how long the timer has left to run.



The time up until the program starts will count down in the display in hours for durations above 10 hours, and in minutes for durations below 10 hours.

At the end of the delay period, the program selected begins automatically. The time left will appear in the time display and the  *Timer* indicator light will go out.

Starting a program before the time for the timer has elapsed:

A program can be started before the time for the timer has elapsed.

Proceed as follows:

- Open the door.
- Turn the dishwasher off with the  button.
- Turn the dishwasher on again with the  button.
- Select the program you want.
- Start the program by closing the door.

Program overview

| Program | When to use | Program sequence | | | | |
|---------------------|--|------------------|--------------------|---------------|----------------------|--------|
| | | Pre-wash | Main wash °F/°C | Interim rinse | Final rinse °F/°C | Drying |
| Normal ¹ | Program for regular use to completely wash a full load of normally soiled dishes with the ability to adjust energy and water consumption based on the soil load of the dishes. | ✓ | 140–158/60–70 | ✓ | 140–149/60–65 | ✓ |
| Pots & Pans | For heavily soiled dishes and normally soiled pots, pans and utensils with dried on residue; use 20% more detergent than recommended. | ✓ | 167/75 | ✓ | 158/70 | ✓ |
| Quick-Intense-Wash | “Quick program” for standard dishes soiling that has not dried on. | - | 149/65 | ✓ | 140/60 | ✓ |
| SaniWash | To sanitize dishware, e.g. baby bottles, cutting boards and preparation dishes. | - | 167/75 | ✓ | 167/75 | ✓ |
| Rinse & Hold | To rinse dishes when a complete program is not needed. | ✓ | - | - | - | - |

¹ This program is used for energy labeling purposes.

Program overview

| Consumption ² | | | Duration ² | |
|--------------------------------|--------------------------------|----------------|----------------------------------|----------------------------------|
| Energy | | Water | | |
| Cold water 50°F/10°C kWh | Hot water 120°F/49°C kWh | Gallons/Liters | Cold water 50°F/10°C h:min | Hot water 120°F/49°C h:min |
| 1.01 | 1.15 | 3.2/12.1 | 3:02 | 2:44 |
| 1.35 | 1.45 | 2.9/11.0 | 3:16 | 2:56 |
| 1.00 | 1.10 | 2.6/10.0 | 1:12 | 0:58 |
| 1.30 | 1.35 | 2.1/8.0 | 2:40 | 2:24 |
| 0.01 | 0.15 | 0.9/3.5 | 0:21 | 0:21 |

² Values were calculated under standardized testing conditions. In practice there may be variations to these figures due to variable conditions and data recorded by the sensors. Durations shown will reflect your household conditions. Selecting program options will also affect consumption levels and program durations (see “Options”).

The energy consumption with a hot water supply includes the energy used to heat the water (exception: EnergySaver, if available).

Program options

Express

The  *Express* program option reduces the program cycle time.

In order to achieve optimum cleaning results, the temperature, and therefore the energy consumption, will increase with this option.

The time by which the program cycle time is shortened varies according to the selected program.

Selecting the  *Express* program option may take precedence over other selected options.

- Open the door.
- Turn the dishwasher on with the  button.

The indicator light for the program selected will flash.

- Select a different program as required.
- Press the  *Express* button.

The  *Express* indicator light will come on if the program option is available for the program selected.

- Start the program by closing the door.

The selected program option will remain active for that particular program until the setting is changed.





Audible signals

A sequence of audible tones will sound at the end of the program or if there is a fault.

The audible signals at the end of a program and the alarm tone in the event of a fault will sound four times at intervals with a short pause between each set.

The audible signals are switched off as standard.

You can switch on the signals that sound at the end of a program if you wish. The alarm tone that sounds in the event of a fault is always switched on.



- Open the door.
- Turn the dishwasher off with the  button, if it is turned on.
- Press the  button in and, **while holding it in**, turn the dishwasher on using the  button. Keep the  button pressed in for at least 4 seconds until the  indicator light comes on.

If this does not happen, start the procedure from the beginning again.

- Press the *Program* button 4 times.

The top left program indicator light will flash rapidly 4 times at intervals.

The flashing sequence in the time display indicates whether the audible signals at the end of the program are activated or deactivated:

- : audible signals are activated
- : audible signals are deactivated

- Press the  button to change the setting.





The setting is now saved.

- Turn the dishwasher off with the  button.

Program options

Turning off the refill reminders

If you only ever use combination detergent products containing salt and rinse aid in your dishwasher, you can turn off both refill reminders if you wish.

- Open the door.
- Turn the dishwasher off with the  button, if it is turned on.
- Press the  button in and, **while holding it in**, turn the dishwasher on using the  button. Keep the  button pressed in for at least 4 seconds until the  indicator light comes on.

If this does not happen, start the procedure from the beginning again.

- Press the *Program* button 9 times.

The top left program indicator light will flash rapidly 9 times at intervals.

The flashing sequence in the time display will show whether the refill reminders are switched on or off.

- *P 1*: refill reminders are activated
- *P 0*: refill reminders are deactivated

- Press the  button to change the setting.

The setting is now saved.





- Turn the dishwasher off with the  button.

Please make sure that if you stop using combination detergents, you refill the reactivation salt and rinse aid (depending on model). Turn the refill reminders back on.

Extra clean

You can choose this program option to increase the cleaning performance of the programs.

If you activate this program option, the program cycle times and the main wash temperatures will increase. The water and energy consumption may increase.

- Open the door.
- Turn the dishwasher off with the  button, if it is turned on.
- Press the  button in and, **while holding it in**, turn the dishwasher on using the  button.
Keep the  button pressed in for at least 4 seconds until the  indicator light comes on.

If this does not happen, start the procedure from the beginning again.

- Press the *Program* button 10 times.

The top left program indicator light will emit 1 long flash at intervals.

The flashing sequence in the time display indicates whether the Extra clean program option is activated or not:

- P 1: Extra clean is activated
- P 0: Extra clean is deactivated

- Press the  button to change the setting.

The setting is now saved.





- Turn the dishwasher off with the  button.

Program options

Extra Dry

You can select this program option in order to increase the program drying performance.

If you activate this program option, the program cycle times and final rinse temperatures will increase. The energy consumption may increase.

- Open the door.
- Turn the dishwasher off with the  button, if it is turned on.
- Press the  button in and, **while holding it in**, turn the dishwasher on using the  button. Keep the  button pressed in for at least 4 seconds until the  indicator light comes on.

If this does not happen, start the procedure from the beginning again.

- Press the *Program* button 11 times.

The top left program indicator light will emit 1 long flash and 1 short flash at intervals.

The flashing sequence in the time display indicates whether the Extra Dry program option is activated or not:

- P 1: Extra Dry is activated
- P 0: Extra Dry is deactivated





- Press the  button to change the setting.

The setting is now saved.

- Turn the dishwasher off with the  button.

Factory defaults

If you have altered any settings, you can reset them back to the factory default settings.

- Open the door.
- Turn the dishwasher off with the  button, if it is turned on.
- Press the  button in and, **while holding it in**, turn the dishwasher on using the  button. Keep the  button pressed in for at least 4 seconds until the  indicator light comes on.

If this does not happen, start the procedure from the beginning again.

- Press the *Program* button 19 times.

The top left program indicator light will emit 1 long flash and 9 short flash at intervals.

The flashing sequence in the time display indicates whether the setting deviates from the factory default:

- *P 1*: all values are factory default settings.
- *P 0*: at least one setting has been changed.

- To reset the dishwasher to the factory default settings, press the  button.

The setting is now saved.

- Turn the dishwasher off with the  button.

Cleaning and care

Check the condition of your dishwasher regularly (approx. every 4–6 months). This helps to avoid faults and problems.

 Damage due to unsuitable cleaning agents.

All surfaces are susceptible to scratching. Contact with unsuitable cleaning agents can alter or discolor all surfaces.

Only use cleaning agents formulated for use on the relevant surfaces.

Cleaning the wash cabinet

The wash cabinet is largely self-cleaning, provided that the correct amount of detergent is always used.

If, despite this, limescale or grease deposits build up in the cabinet, these can be removed with a proprietary dishwasher cleaner (available from the Miele Customer Service or Miele's online store). Follow the dosage recommended by the manufacturer on the packaging.

The frequent use of low-temperature wash programs increases the risk of contamination and odors inside the wash cabinet. Run the *Pots & Pans* program once per month to clean the wash cabinet and prevent odors from developing.

- Clean the filters in the wash cabinet regularly.

Cleaning the door and the door seal

The door seal and the sides of the dishwasher door are not accessed and cleaned by the spray arm jets. As a result, mold can develop here.

- Wipe the door seals regularly with a damp cloth to remove food deposits.
- Wipe off any food or drink residues which may have dripped onto the sides of the dishwasher door before closing it.

Cleaning the control panel

- The control panel should **only** be wiped with a damp cloth.

Cleaning the front of the machine



Damage due to soiling.

Soiling that is left too long might become impossible to remove and could cause the external surfaces to alter or discolor.

It is therefore best to remove any soiling immediately.

- Clean the appliance front with a clean soft sponge and a solution of warm water and liquid dish soap. After cleaning, wipe the surfaces dry using a soft cloth.

A clean, damp microfiber cloth without detergent can also be used.

To avoid damaging the external surfaces, do not use the following:

- cleaning agents containing soda, ammonia, acids, or chloride
- cleaning agents containing lime scale remover
- abrasive cleaning agents, such as scouring powder, scouring liquid, or pumice stones
- cleaning agents containing solvents
- stainless-steel cleaning agents
- dishwasher cleaner
- oven cleaner
- glass cleaner
- hard, abrasive brushes or sponges, e.g., pot scourers, brushes, or sponges which have been previously used with abrasive cleaning agents
- eraser sponges
- sharp metal scrapers
- steel wool
- steam cleaners

Cleaning and care

Cleaning the spray arms

Particles of food can get stuck in the spray-arm jets and bearings. The spray arms should therefore be inspected regularly (approx. every 2–4 months).

Never run a wash program without using the spray arms.

⚠ Damage due to soiling entering the circulation system.

Without filters, soiling can enter the circulation system and cause a blockage.

Do not run a wash program without the lower spray arm or without the filters.

When cleaning the filters and spray arms, make sure that coarse soiling cannot get into the circulation system.

- Turn off the dishwasher.

Removing the cutlery tray (if present)

In order to be able to remove the upper spray arm, you first have to remove the cutlery tray (if present).

- Pull out the cutlery tray.

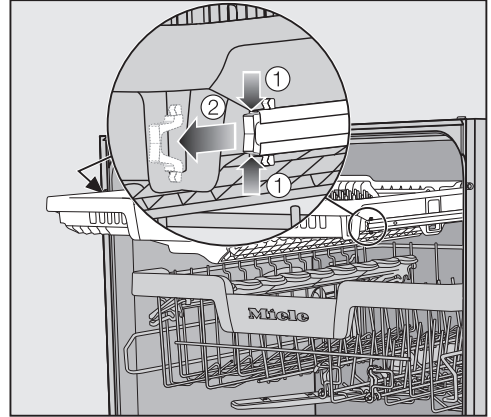

- Press the rail safety clips on both sides of the cutlery tray together ① and remove the safety clips ②.
- Take out the cutlery tray completely.

Removing the upper spray arm

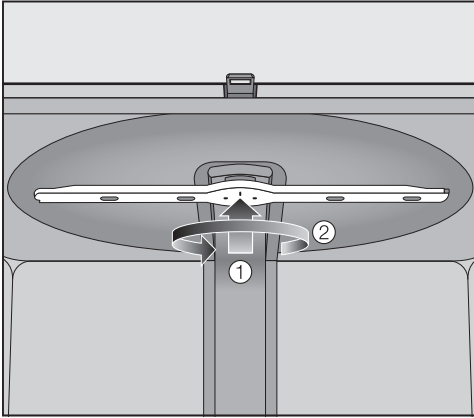

- Push the upper spray arm upward ① to engage the inner ratchet. Then unscrew the spray arm by rotating the screw thread counterclockwise ②.

Removing the middle spray arm

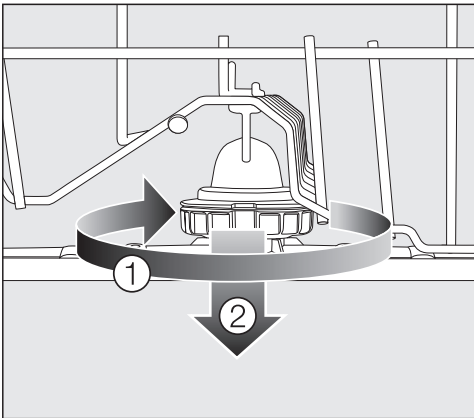

- Rotate the screw thread of the middle spray arm clockwise ① and remove the spray arm ②.

Removing the lower spray arm

- Remove the lower basket.

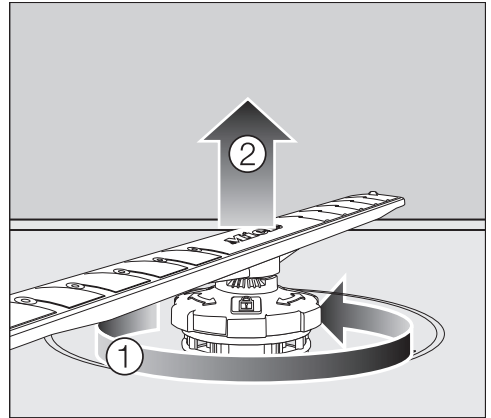

- Rotate the screw thread of the lower spray arm counterclockwise ① and pull the spray arm upward to remove ②.

Cleaning the spray arms

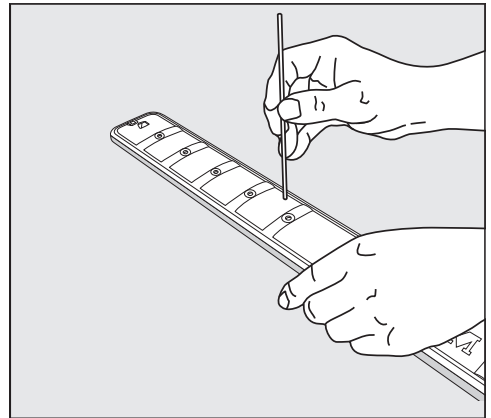



- Use a pointed object to push food particles that are stuck in the spray-arm jets into the spray arm.
- Rinse the spray arm thoroughly under running water.

Cleaning and care

Reinstalling the spray arms

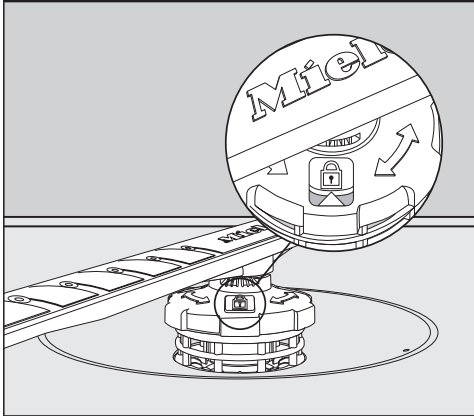
- Reinstall the upper spray arm and tighten it by hand.
- Reinstall the middle spray arm.
- Reinstall the lower spray arm and ensure that the filter combination lies flat in the base of the wash cabinet.



- Rotate the screw thread of the lower spray arm clockwise until the arrow in the viewing window points to the lock symbol .
- Make sure the spray arms can rotate freely.

 Damage due to soiling entering the circulation system.

The lower spray arm is used to secure the filter combination. Without filters, coarse soiling can enter the circulation system and cause a blockage.

Do not run a wash program without the lower spray arm or without the filters.

Inserting the cutlery tray (if present)

- Slide the cutlery tray back onto the rails from the front.
- Replace the safety clips in the rails on both sides of the cutlery tray.

Checking the filters in the wash cabinet

The filter combination in the base of the wash cabinet retains coarse soil from the suds solution. This prevents soiling getting into the circulation system and re-entering the wash cabinet through the spray arms.

 **Damage due to soiling entering the circulation system.**

Without filters, soiling can enter the circulation system and cause a blockage.

Do not run a wash program without the lower spray arm or without the filters.

When cleaning the filters and spray arms, make sure that coarse soiling cannot get into the circulation system.

The filters can become blocked by soiling that collects over time. The level of soiling and time it takes before the filters need cleaning will vary depending on use.

- Monitor the condition of the filter combination regularly and clean it if necessary.

Cleaning the filters

- Turn off the dishwasher.
- Remove the lower spray arm (see “Cleaning the spray arms” under “Cleaning and care”).
- Before removing the filter combination, remove any coarse soiling to prevent it from entering the circulation system.

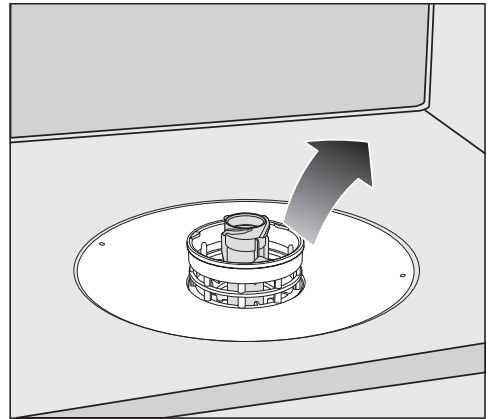

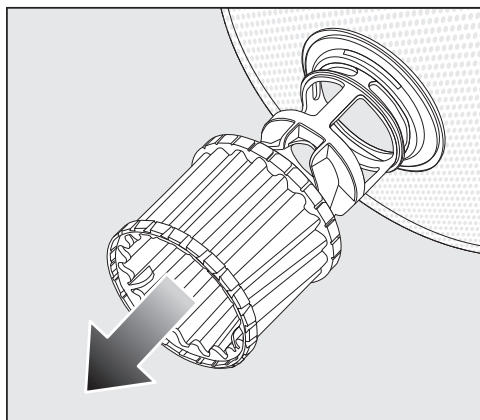

- Remove the filter combination.

Cleaning and care

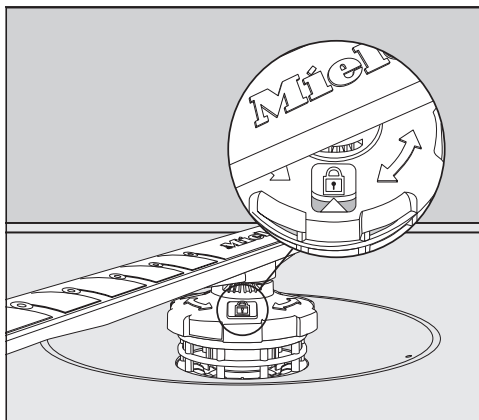

- In order to clean the inside of the filter, pull the microfilter on the plastic ring downwards and away from the filter combination.
- Rinse all of the filters under running water.
If necessary, use a soft cleaning brush to remove soiling.
- Insert the microfilter back into the filter combination.
- Reinstall the filter combination so that it lies flat in the base of the wash cabinet.
- Refit the lower spray arm to the filter combination using the screw thread.



- Rotate the screw thread clockwise until the arrow in the viewing window points to the lock symbol .

 Damage due to soiling entering the circulation system.

The lower spray arm is used to secure the filter combination. Without filters, coarse soiling can enter the circulation system and cause a blockage.

Do not run a wash program without the lower spray arm or without the filters.

Cleaning the water-intake filter

A filter is incorporated in the screw connection to protect the water-intake valve. If the filter is soiled, insufficient water flows into the wash cabinet.

 Risk of electric shock from voltage.

The plastic housing of the water connection contains an electrical valve. The housing must not be dipped in water.

- Disconnect the dishwasher from the power supply.
To do this, turn off at the electrical socket and withdraw the plug.
- Turn off the water-supply faucet.
- Unscrew the water-intake valve.

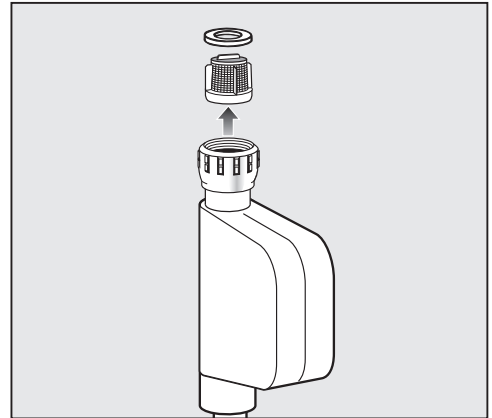

- Take the seal ring out of the screw connection.
- Using pointed pliers, take hold of the plastic filter bar and pull it through the filter.
- Rinse the filter under running water.
- Reassemble in reverse order.

Screw the screw connection securely back onto the faucet. Slowly open the faucet. If water drips out, tighten the connection.

Never forget to put the filter back in place after cleaning.

Cleaning and care

Cleaning the drain pump

If water remains in the wash cabinet after the end of a program, the water has not been pumped away. The drain pump may be blocked by foreign objects. These foreign objects are easy to remove.

- Disconnect the dishwasher from the power supply.
To do this, turn off at the electrical socket and withdraw the plug.
- Take the filter combination out of the wash cabinet (see “Cleaning the filters” under “Cleaning and care”).
- Scoop the water out of the wash cabinet using a suitable small container or utensil.

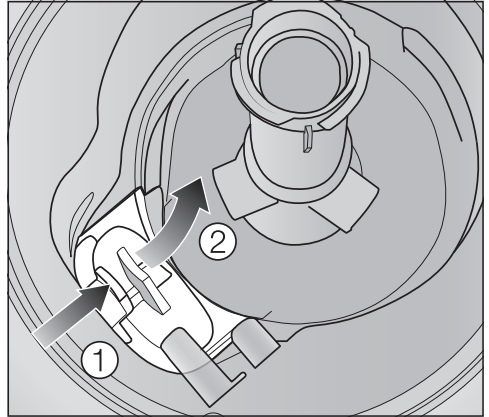

- Press the catch of the drain pump cover inwards ①.
- Tip the cover inwards until it is released ②.
- Rinse the cover thoroughly under running water and remove all foreign objects.

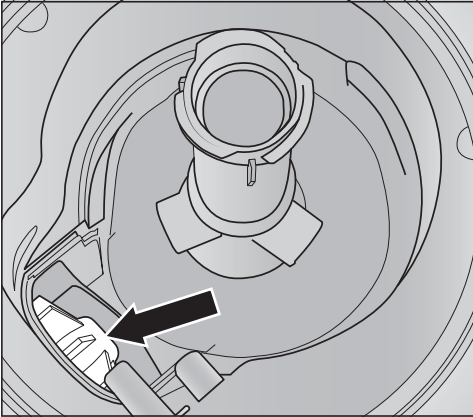

The drain pump (see arrow) is underneath the cover.

! Risk of injury from glass splinters.

It is especially difficult to see glass splinters in the drain pump.

Take care when cleaning the drain pump.

- Carefully remove all foreign objects from the drain pump. Check the drain pump impeller by manually turning it. You will feel a little resistance when you turn the impeller.
- Refit the cover by placing it down vertically from above.

Ensure that the catch engages correctly.

! Damage due to incorrect cleaning.

The components are delicate and can be damaged during cleaning. Take care when cleaning the drain pump.





Frequently Asked Questions

With the help of the following guide minor faults in the performance of the machine, some of which may result from incorrect operation, can be remedied without contacting the Service Department.

This guide may help you to find the reason for the fault, and how to correct it.

This section only lists faults that you can remedy yourself. All other faults are shown in  Fault FXX.

Technical faults



| Problem | Possible cause and solution |
|---|---|
| The dishwasher does not start. | The door is not properly closed. <ul style="list-style-type: none"> ■ Raise the door upward until the catch engages. |
| | The dishwasher is not plugged in. <ul style="list-style-type: none"> ■ Insert the plug. |
| | The circuit breaker has tripped. <ul style="list-style-type: none"> ■ Reset the breaker (see data plate for the correct fuse rating). ■ If the breaker trips again, contact Miele Customer Service. |
| | The dishwasher is not turned on. <ul style="list-style-type: none"> ■ Turn the dishwasher on with the  button. |
| The  button does not respond immediately or only responds once it has been pressed several times. | Energy management: the door was opened or closed shortly before the  button was pressed. As a result, the dishwasher was already switched on. The electronic module requires a few seconds to be ready for operation. <ul style="list-style-type: none"> ■ Wait a few seconds after opening or closing the door. ■ Then press the  button. |
| The dishwasher stops during a program. | The circuit breaker has tripped. <ul style="list-style-type: none"> ■ Reset the circuit breaker (see data plate for the correct fuse rating). ■ If the circuit breaker trips again, contact Miele Customer Service. |

Fault messages

| Problem | Possible cause and solution |
|---|--|
| <p>The alarm tone is sounding. Fault number <i>FXX</i> appears in the time display.</p> | <p>There may be a technical fault.</p> <ul style="list-style-type: none"> ■ Turn the dishwasher off with the  button. ■ Turn the dishwasher back on after a few seconds. ■ Select the program you want to use. ■ Close the door. <p>If the indicator lights flash again, there is a technical fault.</p> <ul style="list-style-type: none"> ■ Turn off the dishwasher. ■ Turn off the water-supply faucet. ■ Contact Miele Customer Service. |
| <p>Fault <i>F70</i>: The drain pump may still be running, even with the door open.</p> | <p>The Waterproof system has reacted.</p> <ul style="list-style-type: none"> ■ Turn off the dishwasher. ■ Turn off the water-supply faucet. ■ Contact Miele Customer Service. |
| <p>The alarm tone is sounding. When the door is open, all of the program selection indicator lights are flashing. Fault number <i>F78</i> appears in the time display.</p> | <p>Circulation-pump fault.</p> <ul style="list-style-type: none"> ■ Turn off the dishwasher. ■ Turn the dishwasher back on. ■ Select the program you want to use. ■ Close the door. <p>If the fault message appears again, there is a technical fault.</p> <ul style="list-style-type: none"> ■ Turn off the dishwasher. ■ Turn off the water-supply faucet. ■ Contact Miele Customer Service. |

Frequently Asked Questions

Water intake fault

| Problem | Possible cause and solution |
|--|--|
| <p>The dishwasher stops working shortly after the program starts. The alarm tone is sounding. The  indicator light flashes on and off. <i>F</i> and 173 appear alternately on the time display.</p> | <p>The water supply is turned off.</p> <ul style="list-style-type: none"> ■ Open the shut-off valve all the way. |
| <p>The dishwasher stops during a program. The alarm tone is sounding. The  indicator light is flashing. The fault number <i>F12</i> or <i>F13</i> appears in the display.</p> | <p>Before remedying the fault:</p> <ul style="list-style-type: none"> ■ Turn the dishwasher off with the  button. <p>Water-intake fault.</p> <ul style="list-style-type: none"> ■ Open the shut-off valve all the way and start the program again. ■ Clean the water-intake filter (see “Cleaning the water-intake filter” under “Cleaning and care”). ■ The water-connection pressure is lower than 7.25 psi (50 kPa). Seek professional advice. ■ The on-site connection for the water drainage may be too low and you will need to vent the water drainage (see “Water drainage” under “Installation”). |
| <p>The dishwasher stops during a program. Fault number <i>F18</i> appears in the time display.</p> | <p>A technical fault has occurred.</p> <ul style="list-style-type: none"> ■ Turn off the dishwasher. ■ Close the shut-off valve. ■ Contact Miele Customer Service. |

Water drainage fault

| Problem | Possible cause and solution |
|---|--|
| The dishwasher stops during a program. The alarm tone is sounding. The  indicator light is flashing. Fault number <i>F11</i> appears in the time display. | Before remedying the fault: ■ Turn off the dishwasher. Water-drainage fault. There might be water in the wash cabinet. ■ Clean the filter combination (see “Cleaning the filters” under “Cleaning and care”). ■ Clean the drain pump (see “Cleaning the drain pump” under “Cleaning and care”). ■ Remove any kink or loop in the drain hose. |

Frequently Asked Questions

General dishwasher problems

| Problem | Possible cause and solution |
|--|---|
| <p>The alarm tone is sounding. The indicator light for the selected program and the time display will flash. The dishwasher does not start or the delay-start time stops running.</p> | <p>The safe mode of the dishwasher was activated. This takes place in the following instances:</p> <ul style="list-style-type: none"> – if you do not close the door within 4 seconds of the last press of a button at program start – if the door is open for longer than 4 seconds during a program or within the delay-start time <p>■ Press the program selection button and close the door within 4 seconds.</p> |
| <p>The indicator lights and time display are dark.</p> | <p>The dishwasher has turned off automatically to save energy.</p> <p>■ Turn the dishwasher on again with the  button.</p> |
| <p>Detergent residue is left in the detergent compartment at the end of a program.</p> | <p>The detergent compartment was still damp when detergent was added.</p> <p>■ Only add the detergent when the detergent compartment is dry.</p> |
| <p>The detergent compartment lid cannot be closed.</p> | <p>Residual detergent is blocking the catch.</p> <p>■ Remove the residual detergent.</p> |
| <p>At the end of a program there is a film of moisture on the inside of the door and possibly on the interior cabinet walls.</p> | <p>This is part of the normal function of the drying system. The moisture will dissipate after a short time.</p> |
| <p>Water remains in the wash cabinet at the end of a program.</p> | <p>Before remedying the fault:</p> <p>■ Turn off the dishwasher.</p> |
| | <p>The filter combination in the wash cabinet is clogged.</p> <p>■ Clean the filter combination (see “Cleaning the filters” under “Cleaning and care”).</p> |
| | <p>The drain pump is blocked.</p> <p>■ Clean the drain pump (see “Cleaning the drain pump” under “Cleaning and care”).</p> |
| | <p>The drain hose is kinked.</p> <p>■ Remove any kinks from the drain hose.</p> |

Frequently Asked Questions

| Problem | Possible cause and solution |
|--|---|
| Build-up of odors in the wash cabinet | <p>The frequent use of low-temperature wash programs (< 122°F/50°C) increases the risk of contamination and odors inside the wash cabinet.</p> <ul style="list-style-type: none">■ Regularly run a high-temperature program. This is to prevent contamination and odors. |

Frequently Asked Questions

Noises

| Problem | Possible cause and solution |
|---|--|
| There is a knocking noise in the wash cabinet. | A spray arm is knocking against a wash item. ■ Carefully open the door and rearrange the wash items that are obstructing the spray arm. |
| There is a rattling noise in the wash cabinet. | Wash items are not secure in the wash cabinet. ■ Carefully open the door and rearrange the wash items so that they sit securely. |
| | There is a foreign object (e.g., glass shard) in the drain pump. ■ Remove the foreign object from the drain pump (see “Cleaning the drain pump” under “Cleaning and care”). |
| Knocking noise in the water pipes | This may be caused by the on-site installation or the cross-section of the piping. ■ However, this will not affect the functioning of the dishwasher in any way. If in doubt, contact a suitably qualified plumber. |

Frequently Asked Questions

Poor cleaning results

| Problem | Possible cause and solution |
|---|---|
| The dishes are not clean. | The dishes were not loaded correctly. ■ See notes under “Loading the dishwasher”. |
| | The program was not powerful enough. ■ Select a more powerful program (see “Program overview”). ■ Activate the Extra clean function (see “Extra clean” under “Options”). |
| | Not enough detergent was dispensed during manual detergent dispensing. ■ Use more detergent or change the brand you are using. |
| | Items are blocking the path of the spray arms. ■ Carry out a rotation check and if needed rearrange the items so that the spray arms can rotate freely. |
| | The filter combination in the wash cabinet is not clean or was incorrectly installed. This may have caused the spray-arm jets to become blocked. ■ Clean and/or install the filter combination correctly. ■ Clean the spray-arm jets if necessary (see “Cleaning the spray arms” under “Cleaning and care”). |
| There are streaks on glassware and utensils. There is a bluish sheen on the surface of glassware. The film can be wiped off. | The rinse-aid dosage is set too high. ■ Reduce the dosage (see “Rinse aid” under “Before using for the first time”). |

Frequently Asked Questions

| Problem | Possible cause and solution |
|--|---|
| <p>The dishware is not dry or utensils and glasses are flecked.</p> | <p>The rinse-aid dosage is set too low or the rinse-aid reservoir is empty.</p> <ul style="list-style-type: none"> ■ Replenish the reservoir, increase the dosage, or change the brand of rinse aid (see “Rinse aid” under “Before using for the first time”). |
| | <p>The dishware was taken out of the wash cabinet too soon.</p> <ul style="list-style-type: none"> ■ Leave the dishware in longer (see “Unloading the dishwasher” under “Operation”). |
| | <p>The duration of the drying phase for the selected program is not sufficient for the dishware (particularly for plastic dishware).</p> <ul style="list-style-type: none"> ■ Select the Extra Dry program option (see “Extra Dry” under “Options”). |
| | <p>You have used combination products that have insufficient drying performance.</p> <ul style="list-style-type: none"> ■ Switch to another detergent or replenish the rinse aid (see “Rinse aid” under “Before using for the first time”). |
| <p>Glassware has a brown or blue tinge. The film cannot be wiped off.</p> | <p>Ingredients from the detergent have formed a deposit.</p> <ul style="list-style-type: none"> ■ Switch to another detergent straight away. |
| <p>Glassware is dull and discolored. The film cannot be wiped off.</p> | <p>The glassware is not dishwasher-safe. The surface has altered.</p> <ul style="list-style-type: none"> ■ No remedy. Purchase glassware which is dishwasher-safe. |
| <p>Tea or lipstick stains have not been completely removed.</p> | <p>The wash temperature of the selected program was too low.</p> <ul style="list-style-type: none"> ■ Select a program with a higher wash temperature. |
| | <p>The bleaching effect of the detergent is too low.</p> <ul style="list-style-type: none"> ■ Switch to another detergent. |

Frequently Asked Questions

| Problem | Possible cause and solution |
|---|--|
| <p>Plastic parts are discolored.</p> | <p>Natural dyes, e.g., from carrots, tomatoes, or ketchup may be the cause. The amount of detergent used or its bleaching effect was not sufficient to deal with natural dyes.</p> <ul style="list-style-type: none"> ■ Use more detergent (see “Detergent”). <p>Parts that are already discolored will not revert to their original color.</p> |
| <p>White residue is visible on the dishes. Clouding has occurred on glassware and utensils. The film can be wiped off.</p> | <p>The rinse-aid dosage is set too low.</p> <ul style="list-style-type: none"> ■ Increase the dosage (see “Rinse aid” under “Before using for the first time”). <p>Unsuitable combination detergents were used.</p> <ul style="list-style-type: none"> ■ Switch to another detergent. If using tabs or powder detergent, do not choose combination products and ensure you refill the rinse aid. |
| <p>There are rust stains on the utensils.</p> | <p>The affected items are not corrosion resistant.</p> <ul style="list-style-type: none"> ■ No remedy. <p>Purchase utensils which are dishwasher-safe.</p> |

Customer Service

Contact in the event of a fault

In the event of a fault which you cannot remedy yourself, please contact your Miele dealer or Miele Customer Service.

You can book a Miele Service Call online at www.miele.com/service.

Contact information for Miele Customer Service can be found at the end of this document.

Please quote the model identifier and serial number of your appliance (SN) when contacting Miele Customer Service. Both pieces of information can be found on the data plate.

The data plate is located on the right side of the door.

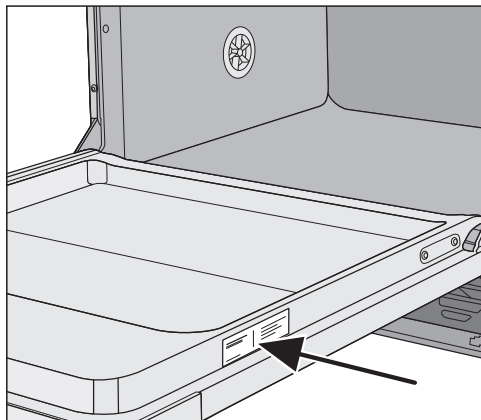

Appliance warranty and product registration

You can register your product and/or view the manufacturer's warranty terms and conditions for Miele appliances and vacuum cleaners at www.mieleusa.com.

Dishwasher detergent, rinse aid, and cleaning and care products are available for this dishwasher, as are optional accessories.

All the products have been designed for Miele appliances.

These and many other useful products can be ordered directly from Miele's on-line store, Miele Customer Service, or from your Miele dealer.

Dishwasher detergent and rinse aid

You have chosen excellent quality and performance with your Miele dishwasher. To achieve optimum results all the time, it is important to use the right dishwasher detergents. Not all off-the-shelf products deliver the same results in all dishwashers.

For this reason Miele offers dishwasher products specifically designed for Miele appliances.

Detergent tabs

- Sparkling results even with stubborn food deposits
- Combination product with other functions such as rinse aid, salt, and glass protection additives
- Phosphate-free – kind to the environment
- Water-soluble wrapping – no need to unwrap

Rinse aid

- For sparkling glasses
- Helps dishes to dry

- With glass-protection formula against corrosion
- Specially designed cap for accurate and easy dispensing

Optional accessories

Appliance care

Miele cleaning and care products provide optimum care for your dishwasher.

Dishwasher cleaner

- For use with the Clean Machine program without detergent dispensing
- Cleans the dishwasher effectively and thoroughly
- Removes grease, bacteria, and associated unpleasant odors
- Ensures excellent dishwashing results

Descaling agent

- Removes heavy limescale deposits
- Mild and gentle with natural citric acid

Dishwasher conditioner

- Removes odors, limescale, and light deposits
- Maintains the elasticity and leak tightness of the seals

Dishwasher freshener

- Neutralizes unpleasant odors
- Fresh, pleasant lime and green tea scent
- Easy and convenient to attach to the dishwasher basket
- Very economical; lasts for 60 rinses

The Miele Waterproof System

Provided your dishwasher has been installed correctly, the Miele Waterproof System will protect you from water damage.

Water intake

 Danger to health due to wash water.

Water in the dishwasher must not be used as drinking water.

Do not drink any water from the dishwasher.

 Health risk and risk of damage due to contaminated incoming water.

The quality of the incoming water must correspond to the drinking water specification of the country in which the dishwasher is being operated.

Connect the dishwasher to a drinking water supply.

The dishwasher may be connected to cold or hot water (up to max. 140°F/60°C) supplies.

We recommend connecting to a cold water supply to reduce energy consumption.

If energy-saving water heating sources, such as solar energy circulation systems, are used, we recommend connecting to the hot water. This saves both time and electrical energy costs. Hot water is used in all programs.

The intake hose is approx. 5 ft (1.5 m) long. A 5 ft (1.5 m) long, flexible metal extension hose (tested to 2030 psi/14,000 kPa) is available as an optional accessory from Miele specialist retailers or Miele Customer Service.

Installation

A water supply with 3/8" **Compression Connection** (thread connection of 9/16" – 24 UNEF) must be provided on site. If this type of faucet is not available, only a qualified installer may connect the dishwasher to the domestic water supply.

A backflow preventer is not required. The appliance meets the requirements of the applicable DIN standards.

The water-connection pressure needs to be between 7.25 and 145 psi (50 and 1,000 kPa). If the water-connection pressure is too high, a pressure reducing valve must be installed.

 Risk of damage from leaking water.

The connection point is subject to water pressure. Water leaking from it can cause damage.

You should therefore open the faucet slowly and check for leaks. Correct the position of the seal and screw thread if appropriate.

 Risk of damage from leaking water.

The intake hose is under water pressure.

The intake hose must not be shortened or damaged in any way.

 Risk of damage due to excessive pressure.

A brief increase in the water pressure can damage components of the dishwasher.

This dishwasher must only be operated when it is connected to a fully primed plumbing system.

Water drainage

The appliance drainage system has a non-return valve, which prevents dirty water from flowing back into the dishwasher via the drain hose.

The dishwasher is supplied with approx. 5 ft (1.5 m) of flexible drain hose with an internal diameter of 7/8" (22 mm).

The hose can be extended using a connection piece to attach a further length of hose. The drainage length must not be longer than 13 ft (4 m) and the delivery head no higher than 3 ft (1 m).

If the hose is to be directly connected to the drainage outlet on site, use the supplied hose clip (see the installation diagram).

The hose can be directed to the left or the right of the appliance.

The on-site connector for the drain hose can be used for various hose diameters. If the connector extends too far into the drain hose, it must be shortened. Otherwise, the drain hose can become clogged.

Only use a Miele approved connection piece when extending the drain line.
Only use a Miele extension drain hose.

The drain hose must not be shortened.

Lay the drain hose so that it does not kink and is not being subjected to pressure or tugged.

 Risk of damage from leaking water.

Leaking water can cause damage.
After servicing the appliance, ensure that the drain does not leak.

Installation

Venting the water drainage

If the on-site drainage connection is situated lower than the guide path for the lower basket rollers in the open door, the drainage system must be vented. Otherwise, a siphoning effect during a program can cause the appliance to empty itself of water.

- Open the dishwasher door fully.

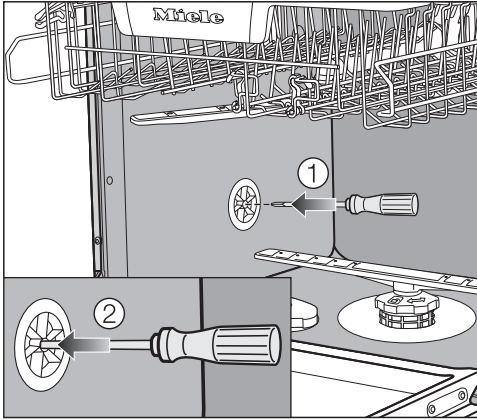

- Remove the lower basket.
- Insert a screwdriver into the middle opening of the vent valve in the left wash cabinet wall ①.
- Press the screwdriver further into the opening and push it through the membrane ② behind.

The vent opening for the water drain is now open.

Electrical connection

 Installation, repairs and other work by unqualified persons could be dangerous.

Check that the voltage, frequency and fuse rating shown on the data plate match the household power supply.

The power outlet must be accessible after installation. Do not use an extension cord to connect the dishwasher to the electrical supply. Danger of overheating! See data plate on the right side of the door.

A damaged power cord must only be replaced with a genuine Miele cord by a Miele service technician.

 Improper connection of the equipment grounding conductor can result in electric shock.

Do not modify the plug provided with the appliance; if it will not fit the outlet, have a proper outlet installed by a qualified electrician.

If there is any question concerning the proper electrical connection or grounding of this appliance to the power supply, please consult a licensed electrician or call Miele's Customer Service Department:
USA: 1-888-99-MIELE(64353)
CDN: 1-800-565-6435

Grounding instructions

THIS APPLIANCE MUST BE GROUNDED.

In the event of a malfunction or breakdown, grounding will reduce the risk of electric shock by providing a path of least resistance for the electrical current. This appliance is equipped with a cord having an equipment grounding conductor and a grounding plug. The plug must be plugged into an appropriate outlet that is installed and grounded in accordance with all local codes and ordinances.

Specifications

The dishwasher comes equipped with a 4 ft (1.2 m) power cord (measured from the rear of the dishwasher) with a molded plug for connection to 120 V, 60 Hz, 15 A grounded receptacle.

Installation

Hardwired electrical connection

It is possible to hardwire this appliance to an existing power cable.

⚠ CAUTION: Before servicing, disconnect the power supply by either removing the fuse, shutting off the power main or manually “tripping” the circuit breaker.

Installation work and repairs should only be performed by a qualified technician in accordance with all applicable codes and standards. Repairs and service by unqualified persons could be dangerous and the manufacturer cannot be held responsible.

Before connecting the appliance to the power supply, make sure that the voltage and frequency listed on the data plate correspond with the household electrical supply. This data must correspond to prevent machine damage. Consult an electrician if in doubt.

GROUNDING INSTRUCTIONS

THIS APPLIANCE MUST BE GROUNDED.

This appliance must be connected to a grounded metal, permanent wiring system, or an equipment-grounding conductor must be run with the circuit conductors and connected to the equipment-grounding terminal or lead on the appliance.

⚠ Prior to making a hardwire connection to the terminal, remove the powercord. Otherwise there will be a risk of electric shock from the attached plug.

An existing flexible supply cord or cable shall have a minimum thickness of AWG 14.

120 V, 60 Hz, 15 A fuse rating

Black wire (live): connect to L

White wire (neutral): connect to N

Green wire (ground): connect to 

⚠ After attaching the permanent power supply cord, check that all wires are correctly and securely placed in the connector and the strain relief is tightened.

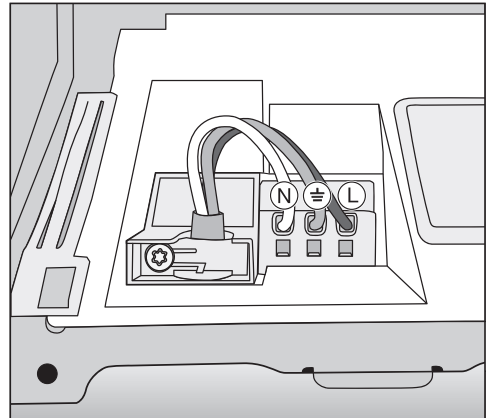

Prerequisites for sound emission tests

Load the dishwasher with **16 standard place settings** and use the *Normal* program.

Setup for sound emission tests

The dishwasher must be set up according to the following specifications.

- Install the dishwasher into an analyzing unit.
- Secure the front panel.

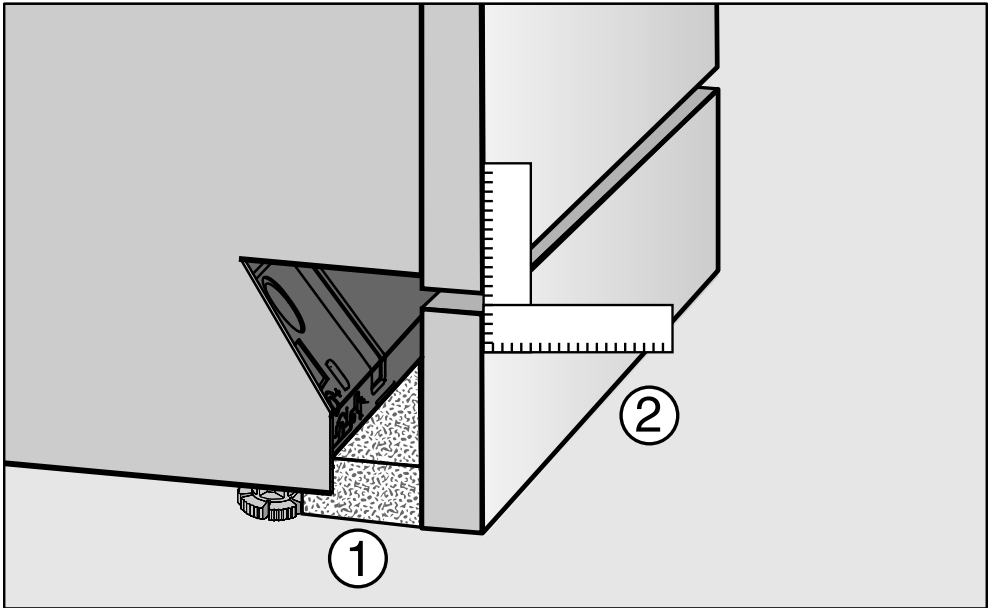

- Push the provided fleece strips (depending on model) under the toe kick until it is flush with the appliance feet ①.
- Push the toe-kick into place in such a way that it is flush with the door panel ②.

Sound emission testing

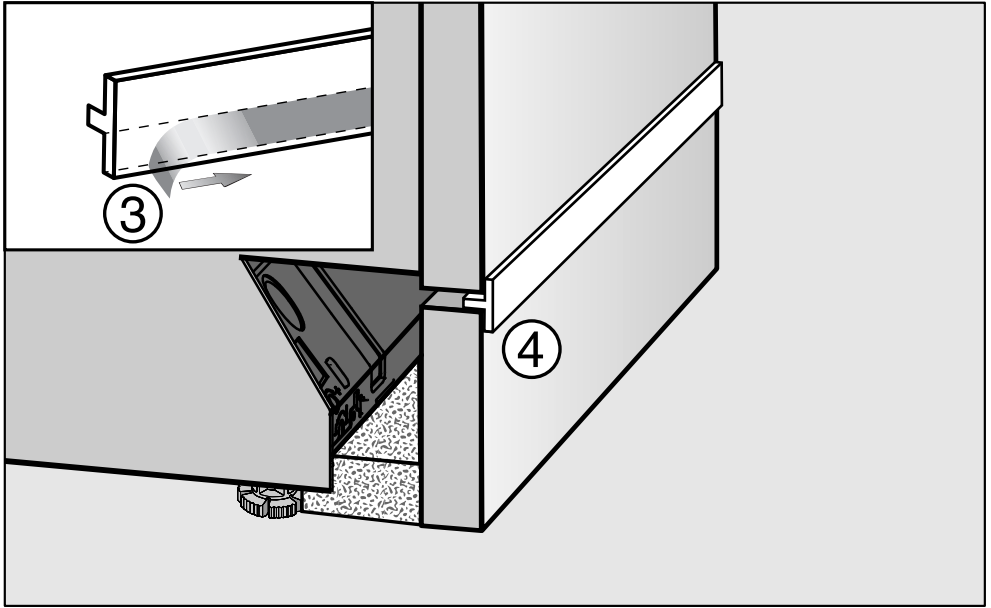

- Remove the protective film from the provided insulating strip (depending on model) ③.
- Stick the insulating strip onto the front top edge of the toe-kick board ④.

**Please have the model and serial number
of your appliance available when
contacting Customer Service.**

U.S.A.

Miele, Inc.

National Headquarters

9 Independence Way
Princeton, NJ 08540
www.mieleusa.com

Customer Support

Phone: 888-99-MIELE (64353)
info@mieleusa.com

International Headquarters

Miele & Cie. KG
Carl-Miele-Straße 29
33332 Gütersloh
Germany

Canada

**Importer
Miele Limited**

Headquarters and Miele Centre

161 Four Valley Drive
Vaughan, ON L4K 4V8
www.miele.ca

Customer Care Centre

Phone: 1-800-565-6435
905-532-2272
customercare@miele.ca

G 5482

en-US

M.-Nr. 11 694 101 / 00