

## Operating Instructions

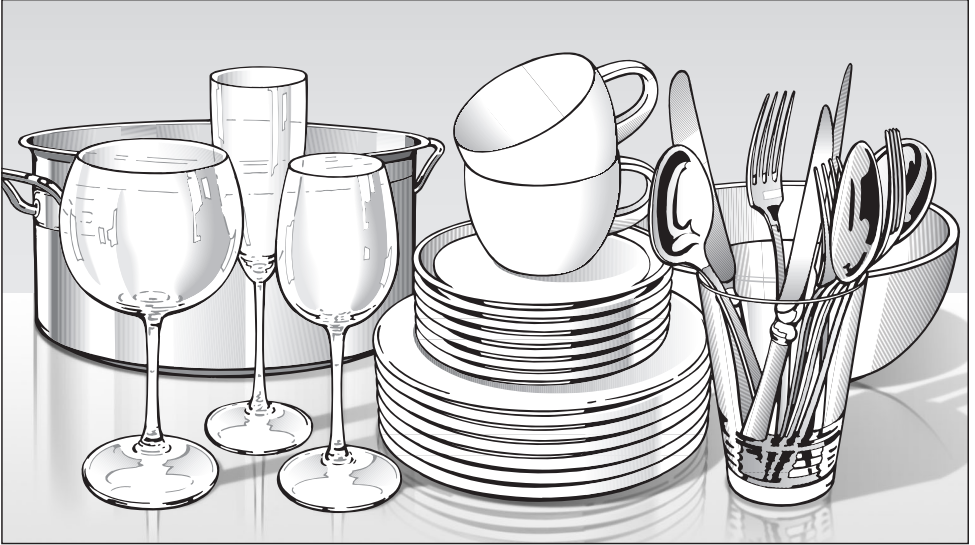

## Dishwasher G 5280 G 5285

To prevent accidents  
and appliance damage  
read these instructions  
**before**  
installation or use.

en - US, CA

M.-Nr. 09 510 220

# Contents

---

<b>IMPORTANT SAFETY INSTRUCTIONS</b> . . . . .	4
<b>Guide to the dishwasher</b> . . . . .	7
Control panel . . . . .	8
<b>Caring for the environment</b> . . . . .	9
<b>Before using for the first time</b> . . . . .	10
To open the door . . . . .	10
To close the door . . . . .	10
Displaying and setting the water hardness . . . . .	12
Filling the salt container . . . . .	13
Salt indicator . . . . .	14
Deactivating refill indicators . . . . .	15
Rinse aid . . . . .	16
Adding rinse aid . . . . .	16
Rinse aid indicator . . . . .	17
Setting the rinse aid dosage . . . . .	18
<b>Loading the dishwasher</b> . . . . .	19
Items not recommended for dishwashing . . . . .	20
Typical load for 10 place settings with cutlery tray . . . . .	21
Typical load for 16 place settings with cutlery tray . . . . .	22
Upper basket . . . . .	23
Lower basket . . . . .	25
MultiComfort zone . . . . .	26
Foldable spikes (depending on the model) . . . . .	26
<b>Optional accessories</b> . . . . .	29
<b>Use</b> . . . . .	30
Detergent . . . . .	30
Adding detergent . . . . .	31
Turning the dishwasher on . . . . .	32
Selecting a program . . . . .	32
Starting a program . . . . .	32
Time display . . . . .	34
Standby . . . . .	34
At the end of a program . . . . .	35
Preparing your appliance for an extended vacation . . . . .	35
Interrupting a program . . . . .	36
Changing a program . . . . .	36

<b>Additional options</b> . . . . .	37
Turbo . . . . .	37
Delay start . . . . .	38
Buzzer . . . . .	39
Optimize Standby . . . . .	40
Factory defaults . . . . .	41
<b>Frequently Asked Questions</b> . . . . .	42
Technical faults . . . . .	42
Faults in the water intake or water drain . . . . .	43
General problems with the dishwasher . . . . .	44
Sounds . . . . .	45
Poor cleaning results . . . . .	46
<b>After sales service</b> . . . . .	49
<b>User Maintenance Instructions</b> . . . . .	51
<b>Cleaning and Care</b> . . . . .	52
Triple filter system . . . . .	53
Cleaning the drain pump and non-return valve . . . . .	56
<b>Installation instructions</b> . . . . .	57
<b>Electrical connection</b> . . . . .	58
<b>Plumbing</b> . . . . .	60
Connection to the water supply . . . . .	60
Drainage . . . . .	61

# IMPORTANT SAFETY INSTRUCTIONS

## WARNING –

**When using your dishwasher, follow basic precautions, including the following:**

Read the operating instructions and installation diagram carefully before installation or use of the dishwasher to prevent injury and machine damage.

Use the dishwasher only for its intended purpose. This appliance is intended for residential use only.

Keep these operating instructions in a safe place and pass them on to any future user.

## Correct usage

▶ The dishwasher is not designed for commercial use. It is intended for use in domestic households and in similar working and residential environments such as, shops, offices and showrooms or guest houses.

▶ The dishwasher is not intended for outdoor use.

▶ It must only be used as a domestic appliance as specified in these operating instructions, for cleaning domestic cookware and cutlery. Any other usage is not supported by the manufacturer and could be dangerous.

▶ Persons who lack physical, sensory or mental abilities, or experience with the appliance should not use the dishwasher without supervision or instruction by a responsible person.

## Electrical Safety

▶ Before installation, make sure that the voltage and frequency listed on the data plate correspond with the household electrical supply. This data must correspond to prevent injury and machine damage. Consult a qualified electrician if in doubt.

▶ Before installation or service, disconnect the power supply to the work area by unplugging the unit, "tripping" the circuit breaker or removing the fuse.

▶ Do not use an extension cord to connect this appliance to electricity. Extension cords do not guarantee the required safety of the appliance (e.g. danger of overheating).

▶ Be certain your appliance is properly installed and grounded by a qualified technician. To guarantee the electrical safety of this appliance continuity must exist between the appliance and an effective grounding system. It is imperative that this basic safety requirement be met. If there is any doubt, have the electrical system of the house checked by a qualified electrician.

▶ If the supplied power cord is damaged it must only be replaced by a Miele Service technician with a genuine Miele power cord.

▶ The outlet must be accessible at all times after installation to disconnect the dishwasher.

# IMPORTANT SAFETY INSTRUCTIONS

## Installation

- ▶ The dishwasher must be installed and connected in accordance with the installation instructions.
- ▶ Installation and repair work should be performed by a Miele authorized service technician. Work by unqualified persons could be dangerous and may void the warranty.
- ▶ Do not install or use a damaged dishwasher. A damaged appliance is dangerous. Unplug the machine and contact Miele Technical Service Department.
- ▶ Ensure that any plastic wrappings, bags, etc. are disposed of safely and kept out of the reach of children. Danger of suffocation!
- ▶ This appliance must not be used in a non-stationary location (e.g. on a boat).
- ▶  **WARNING - Fire hazard!** Do not cover or crush the plug of the appliance. Ensure that the cabinet opening for the dishwasher provides ample space for the plug and cord. Installing the dishwasher in a tight space may crimp the power cord or put pressure on the plug which could cause overheating.
- ▶ This dishwasher should only be installed under a continuous counter top secured to adjacent cabinetry.
- ▶ Do not install this dishwasher beneath a cooking surface, oven or any appliance that radiates heat. High temperatures from these units may damage the dishwasher.
- ▶ A toe-kick must be used with the dishwasher. If the supplied toe-kick is not used, a cabinet matching toe-kick must be installed.
- ▶ Do not install the dishwasher in an area where it will be exposed to temperatures below freezing.
- ▶ Do not cut the intake hose or submerge it in liquid. This hose contains electrical components that could cause injury or property damage if cut or submerged.
- ▶ Only power up the dishwasher when all installation and plumbing work is complete.
- ▶ Do not place hose or power cord next to a heat source e.g. hot water pipes. Do not expose hose or power cord to corrosive substances. Damage of hose or power cord could cause electrical shock or water damage!

# IMPORTANT SAFETY INSTRUCTIONS

---

## Use

- ▶ To reduce the risk of injury, do not allow children to play in, on or near the dishwasher. It is possible for small fingers may be pinched in the door.
- ▶ Only use the dishwasher if all panels are properly in place.
- ▶ Do not tamper with the controls.
- ▶ Do not sit or stand on the door or baskets of the dishwasher. Close the door when not in use.
- ▶ Under certain conditions, hydrogen gas may be produced in a hot water system that has not been used for two weeks or more. HYDROGEN GAS IS EXPLOSIVE. If the hot water system has not been used for such a period, turn on all hot water faucets and let water flow from each for several minutes before using the dishwasher. This will release any accumulated hydrogen gas. Do not smoke or use an open flame during this time.
- ▶ Be sure that all items placed in the dishwasher are "dishwasher safe". For items not labeled, check the manufacturer's recommendations.
- ▶ When loading tableware, place sharp items away from the door to prevent damage to the seal. Load sharp items pointing downwards to prevent injuries.
- ▶ Only use detergents and rinse aids recommended for residential dishwashers. Keep all detergents and rinse aids out of the reach of children.

- ▶ Do not inhale or swallow detergents. Dishwasher detergents contain irritant and corrosive ingredients. They can cause burning in the mouth and throat if swallowed, or inhibit breathing. Consult a doctor immediately if detergent has been swallowed or inhaled.
- ▶ Do not drink water from the dishwasher! Harmful residues could be present.
- ▶ Do not fill the rinse aid reservoir or salt container with detergent. It will destroy the rinse aid compartment and water softener.
- ▶ Dishes can be very hot at the end of a program. Allow the dishes to cool until they are cool enough to handle before unloading them.
- ▶ The water supply must be turned off when the appliance is not used for a longer period of time (e.g. during vacations).

## Disposal of an appliance

- ▶ If the appliance is removed from its installation site and will not be used, remove the doorlock to the wash cabinet to prevent children from locking themselves in the machine.

## SAVE THESE INSTRUCTIONS

# Guide to the dishwasher

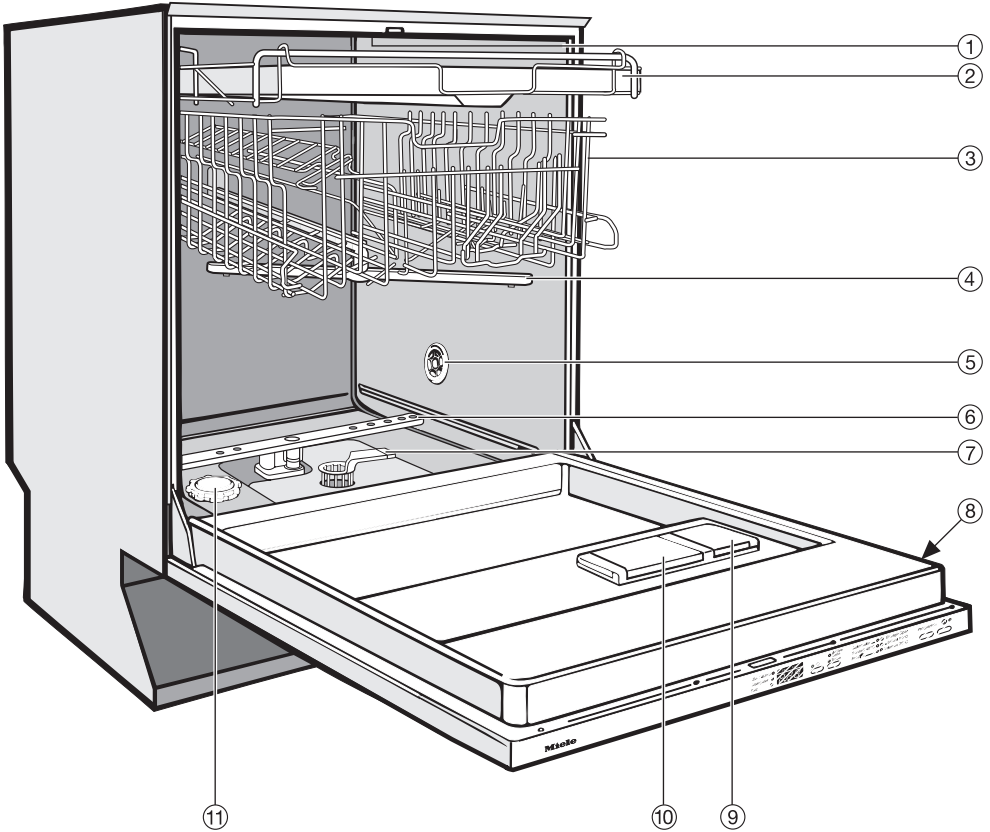

- |   |  |
|---|--|
| ① Upper spray arm (not visible)             | ⑦ Triple filter system                 |
| ② Cutlery tray (depending on model)         | ⑧ Data plate                           |
| ③ Upper basket                              | ⑨ Rinse aid reservoir                  |
| ④ Middle spray arm                          | ⑩ Dual compartment detergent dispenser |
| ⑤ Air inlet for drying (depending on model) | ⑪ Salt container                       |
| ⑥ Lower spray arm                           |  |

# Guide to the dishwasher

## Control panel

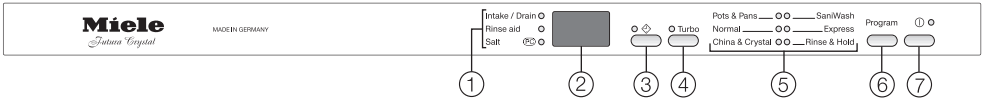

- ① Check / Refill indicators
- ② Time display
- ③ ⇄ button with indicator light  
(Delay start)
- ④ Turbo button with indicator light
- ⑤ Program selection
- ⑥ Program button
- ⑦ ⏻ button (On/Off) with indicator light

This operating instruction manual describes several dishwasher models with different indicated settings.

The different dishwasher models are named :

**Standard** = Dishwasher with 31 11/16" (80.5 cm) height (built-in)  
or 33 1/4" (84.5 cm) height (stand-alone)

**XXL** = Dishwasher with 33 1/4" (84.5 cm) height.

## Energy saving washing

This dishwasher is economical in the use of water and electricity. For best results follow these tips:

- For lowest energy consumption you may connect the dishwasher to a cold water source.
- For fastest possible wash times, with slightly higher energy consumption, connect the dishwasher to a hot water source.
- Make full use of the baskets without overloading for the most economical washing.
- Use the correct amount of detergent and rinse aid. Detergent dosage is dependent upon the amount of soiling and type of dishware being washed. See the "Program Guide" for more information.
- When using powder or liquid detergent, reduce the amount to  $\frac{2}{3}$  of the normal amount when washing a small load.
- Choose a program that best suits the degree of soiling and the type of dishes being washed.

## Disposal of the packing material

The cardboard box and packaging protect the appliance during shipping. These materials are biodegradable and recyclable. Please recycle.

Ensure that any plastic wrappings, bags etc. are disposed of safely and kept out of the reach of children.  
Danger of suffocation!

## Disposal of an old machine

Old appliances may contain materials that can be recycled. Please contact your local recycling authority about the possibility of recycling these materials.

Ensure that the appliance presents no danger to children while being stored for disposal. Before discarding an old appliance, unplug it from the outlet, cut off its power cord and remove any doors to prevent hazards.

## Before using for the first time

---

### To open the door

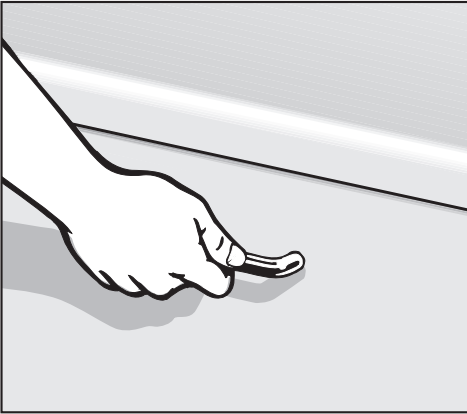

- Pull the handle to open the door.

If the door is opened during operation, the dishwasher will stop running. Once the door is closed the program will continue.

### To close the door

- Push the baskets in.
- Lift the door and push until it clicks into position.

# Before using for the first time

---

## Water hardness

To achieve good cleaning results, the dishwasher needs soft water. Hard water results in calcium deposits on dishware and in the dishwasher.

If your tap water hardness is above 4 °d (4 gr/gal [US]), the water should be softened.

- Your local water authority will be able to advise you of the water hardness level in your area.
- The dishwasher must be programmed to correspond to the water hardness in your area.
- In areas where the water hardness fluctuates (e. g. 37 - 50 °d [39 -52 gr/gal]) always program the machine to the higher value (in this example 50 °d [52 gr/gal]).

It is useful to know your water hardness so that you can provide the service technician with this information in the event of any service calls.

If there is a fault, it will help the service technician to know the hardness of your local water supply.

## The water hardness factory setting is 15°d (16 gr/gal).

If this setting matches your water hardness you need not read any further.



However, if you have a different water hardness you must adjust the water softener to match your water hardness.

Please note your water hardness below:

\_\_\_\_\_ °d (gr/gal)

## Before using for the first time

### Displaying and setting the water hardness

- If the dishwasher is on, press the  button to turn it off.
- Hold down the Program button.
- Press the  button to turn the dishwasher on, and hold the Program button down for at least 4 more seconds until the lower right program indicator lights up.

If it does not come on, start over.

- Press the Turbo button twice.

The Turbo indicator light flashes 2 times at a short interval.

The time display shows the flashing sequence **P 1 5**.

A water hardness of 15°d (16 gr/gal) is set (default setting).

- Using the Program button, select the value that matches your water hardness.

With each press of the button the value will go up one level. Once the highest value is reached the setting will start again from the beginning.

- Press the  button to turn the dishwasher off.

°d	gr/gal	Value to set in the display
1	1	1
2	2	2
3	3	3
4	4	4
5	5	5
6	6	6
7	7	7
8	8	8
9	9	9
10	10	10
11	11	11
12	13	12
13	14	13
14	15	14
<b>15</b>	<b>16</b>	<b>15</b>
16	17	16
17	18	17
18	19	18
19	20	19
20	21	20
21	22	21
22	23	22
23	24	23
24	25	24
25	26	25
26	27	26
27	28	27
28	29	28
29	30	29
30	31	30
31	32	31
32	33	32
33	34	33
34	35	34
35	36	35
36	38	36
37-50	39-52	50
51-60	53-63	60
61-70	64-73	70

## Before using for the first time

---

Every dishwasher is tested before leaving the factory. Any water remaining in the machine is from the final factory test and does not indicate that the machine has been used.

### Filling the salt container

To achieve good cleaning results, the dishwasher needs soft water (water that is low in minerals). Hard water results in calcium deposits on dishware and in the dishwasher.

Therefore, if your tap water hardness is above 4 °d (4 gr/gal) the water should be softened.

 Inadvertently filling the salt container with dishwashing detergent (including liquid detergent) will damage the water softener.

 Only use water softener salt specially formulated for dishwashers. Other salts may contain insoluble additives which can impair the water softener.

If using "Tab" products which include salt, still add salt to the machine to achieve optimal cleaning results and ensure long-term functioning of the water softener.

## Before using for the first time

- Remove the lower basket from the wash cabinet and unscrew the salt container lid.

When opening the salt container, water will run out. Open the container only to refill salt.

**Important:** The salt container must be filled with 2 quarts (2 l) of water **before adding salt for the first time** so the salt can dissolve properly. Water does not have to be added with subsequent refills. First fill the container with approx. 2 liters of water.

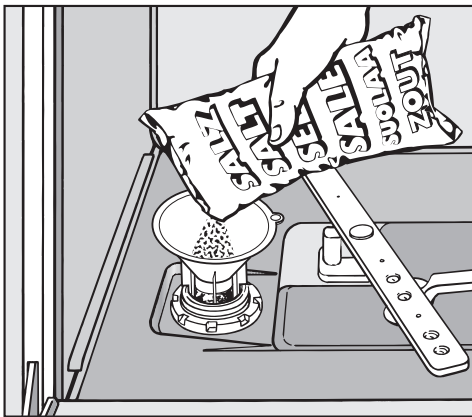

- Place the provided funnel over the salt container and carefully fill it with salt. The salt container holds approx. 4.4 lbs (2 kg) of salt, depending on the type of salt.
- Clean any excess salt from the threads of the container opening. Screw the lid on **firmly**.

- Immediately run the Express program without a load (no Turbo function) to remove any traces of salt or brine from the wash cabinet.

## Salt indicator

- When the Salt indicator comes on, refill the salt container.



The refill salt message may continue to be displayed for a short time after salt has been added. It will go out as soon as a sufficiently high concentration of salt has formed.

The Insufficient salt message is turned off if you have programmed the dishwasher to a water hardness below 4 °d (4 gr/gal).

⚠ Immediately run the Express program without a load (no Turbo function) to remove any traces of salt or brine from the wash cabinet.

### Deactivating refill indicators

If you consistently use Tab detergents, you can deactivate the refill indicators if you wish.

- Press the  button to turn the dishwasher off.
- Hold down the Program button and **simultaneously** turn the dishwasher on using the  button. Keep the Program button pressed for at least four seconds until the lower right program indicator lights up.

If it does not come on, start over.

- Press the Turbo button nine times.

The Turbo indicator light flashes 9 times at a short interval.

The flashing in the time display indicates whether the refill indicators are activated or not.

- "P 1": refill indicators are activated
  - "P 0": refill indicators are deactivated
- Press the Program button if you wish to change the setting.

The setting is immediately saved.

- Press the  button to turn the dishwasher off.

If you switch to a single-function detergent, it is important to remember to add salt and rinse aid and to activate the indicators.

## Before using for the first time

### Rinse aid

Rinse aid helps to prevent spotting on dishes and glassware.

The rinse aid is filled in the reservoir and the set amount will be automatically dosed.

 Filling the rinse aid reservoir with detergent (liquid or powder) will damage the reservoir. Only pour rinse aid formulated for residential dishwashers into the reservoir.

When using "Tab" detergents rinse aid is not needed.

### Adding rinse aid

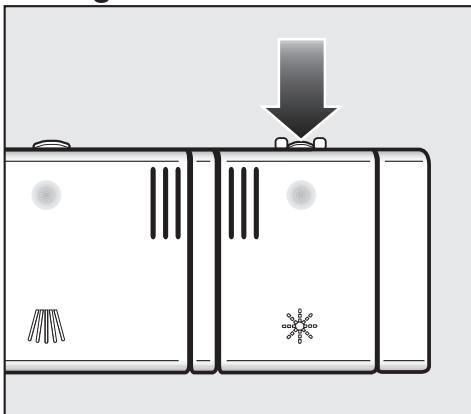

- Press the button on top of the rinse aid reservoir in the direction of the arrow. The flap will pop open.

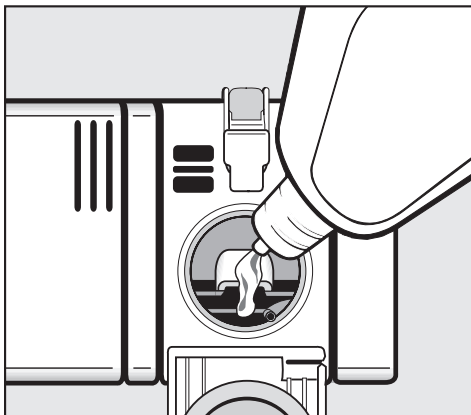

- Pour rinse aid into the reservoir until it is visible in the opening.

The rinse aid reservoir holds approximately 3.7 fl. oz. (110 ml).

- Close the flap until you hear it click shut, otherwise water might enter the reservoir during the wash program.
- Wipe up any spilled rinse aid to prevent over-foaming during the next wash program.

### Rinse aid indicator

When the Rinse aid indicator comes on, the reservoir only contains enough rinse aid for 2 - 3 wash programs.

- Add rinse aid soon.

If you consistently use a detergent that contains salt and rinse aid, you can deactivate the refill indicators if you wish (see Before using for the first time - Deactivating refill indicators).

If you switch to a single-function detergent, it is important to remember to add salt and rinse aid and to activate the indicators.

## Before using for the first time

---

### Setting the rinse aid dosage



The rinse aid dosage can be set at levels between 0 and 6 ml. The factory setting is 3 ml of rinse aid. This is just a recommendation.

If the dishes appear spotty:

- Use a higher setting.

If the dishes appear cloudy or streaky:

- Use a lower setting.

- Press the  button to turn the dishwasher off.
- Hold down the Program button and **simultaneously** turn the dishwasher on using the  button. Keep the Program button pressed for at least four seconds until the lower right program indicator lights up.

If it does not come on, start over.

- Press the Turbo button three times.

The Turbo indicator light flashes 3 times at short intervals.

The time display shows the flashing sequence *P 3*.

The set value is shown in the time display after the *P*.

- Select the desired dosage with the Program button. Every touch of the button increases the level.

The setting is saved immediately.

- Press the  button to turn the dishwasher off.

## Loading the dishwasher

 Do not wash items soiled with ash, sand, wax, grease or paint in the dishwasher.

Ash and sand do not dissolve and will be distributed throughout the inside of the dishwasher.

Wax, grease and paint will cause permanent discoloration and damage to the dishwasher.

- Scrape food from dishes before placing them in the dishwasher, rinsing is not necessary.
  - Some foods contain natural dyes, e.g. carrots or tomatoes. Plastic items may discolor permanently if they come in contact with food dyes.
  - All items can be placed anywhere in the baskets.
  - Load dishes so that water can reach all surfaces. Do not place dishes or cutlery inside other pieces.
  - Make sure that all items are securely positioned.
  - Hollow items such as cups and glasses should be placed upside down in the baskets.
  - To ensure good water coverage, tall, narrow and hollow items, i.e. vases or champagne glasses, should be placed in the center of the basket rather than in the corners.
  - Concave based items such as mugs or bowls, should be placed at an angle so that water does not pool.
- The spray arms must not be blocked by items that are too tall or hang through the baskets. Check clearance by manually rotating the spray arms.
  - Place very small items in the cutlery tray or basket so they do not fall to the bottom of the wash cabinet.
  - Food residue and spilled liquids should be cleaned from the sides of the dishwasher door. These are outside of the wash cabinet and are not cleaned by water from the spray arms.

# Loading the dishwasher

---

## Items not recommended for dishwashing

- Cutlery with wooden handles
- Wooden cutting boards
- Glued items such as old knives with handles glued together around the shank of the blade
- Handmade craft items, antique, metal trimmed or decorative glassware
- Plastic items that are not heat resistant
- Copper, brass, tin or aluminum
- Dishes with color painted over the glaze. These dishes may fade over time
- Fine glassware and crystal items should only be washed using the "China & Crystal" program\*. Otherwise clouding or etching may occur after frequent washing.
- Cast iron pots and pans

\* depending on model

If unsure whether your china and crystal are dishwasher safe, please check with the manufacturer. The China & Crystal program\*, although extremely gentle and thorough can cause the china and crystal to "wear" if they are not dishwasher safe.

## Glassware:

- There are no standard guidelines for washing glassware, when in doubt wash by hand.
- When purchasing new dishes, glasses and cutlery, make sure they are dishwasher safe. Only wash items marked "dishwasher safe" in the dishwasher.
- If fine glassware is washed in the dishwasher select the "China & Crystal" program\*. This will reduce the risk of clouding.

## Silver and aluminum:

- Silver or aluminum items may tarnish.
- Silverware previously cleaned with a silver polish may be damp or spotted at the end of a program where water has adhered to the polish. This can be rubbed off with a soft, dry cloth. Silver that has been cleaned in an immersion dip is usually dry at the end of a program, but may tarnish.
- If left to dry, foods containing sulfur can discolor silver. These include egg yolk, onions, mayonnaise, mustard, fish and marinades.
- Silverware may tarnish or pit if washed next to stainless steel. Leave space between these metals.
- Clean aluminum items, e.g. grease filters, with domestic dishwasher detergent only.

# Loading the dishwasher

## Typical load for 10 place settings with cutlery tray

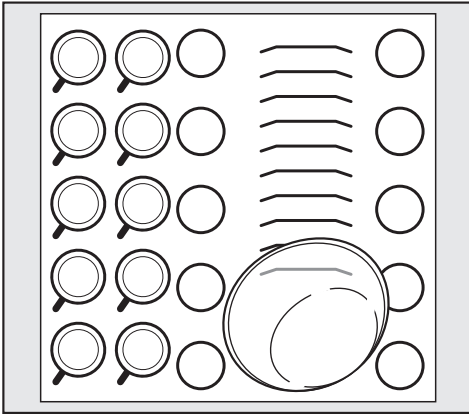

Upper basket

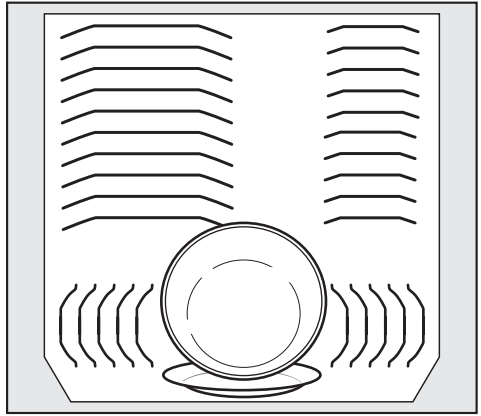

Lower basket

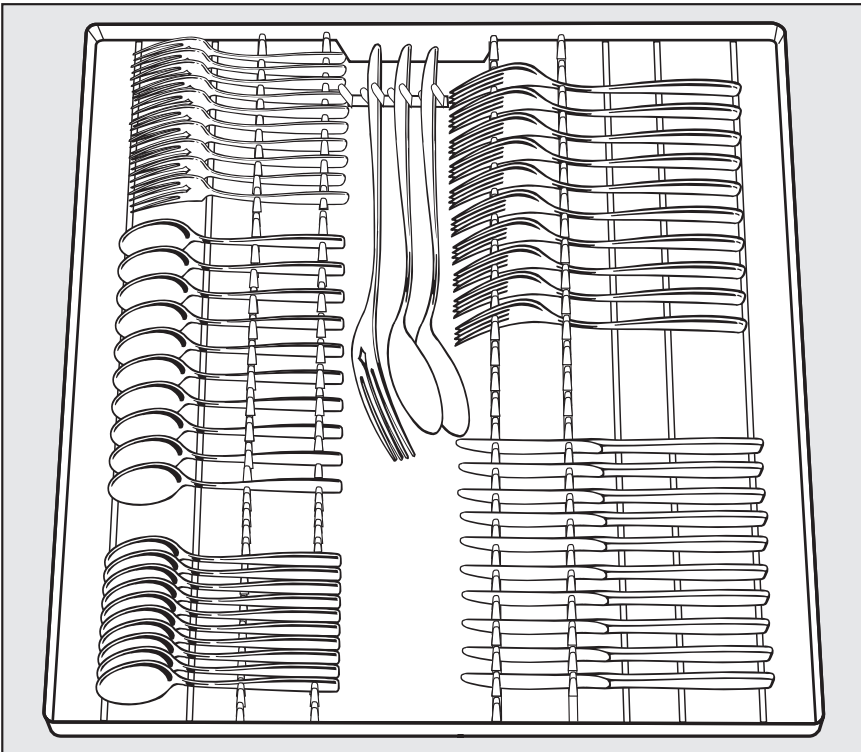

Cutlery tray

# Loading the dishwasher

## Typical load for 16 place settings with cutlery tray

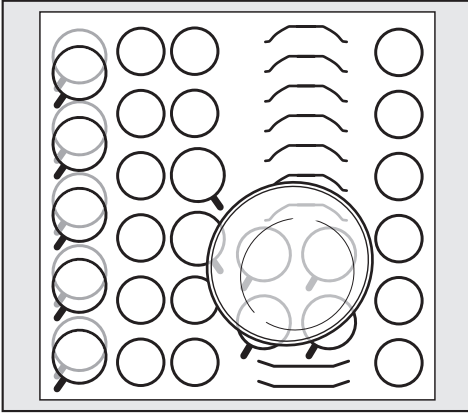

Upper basket

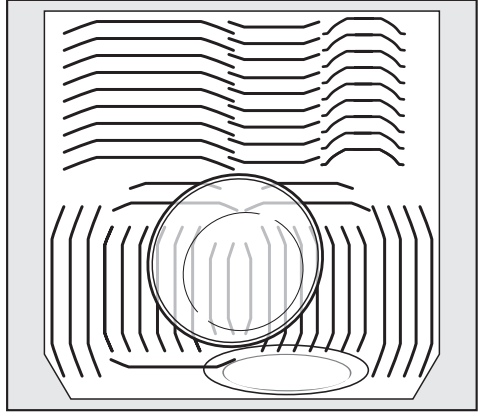

Lower basket

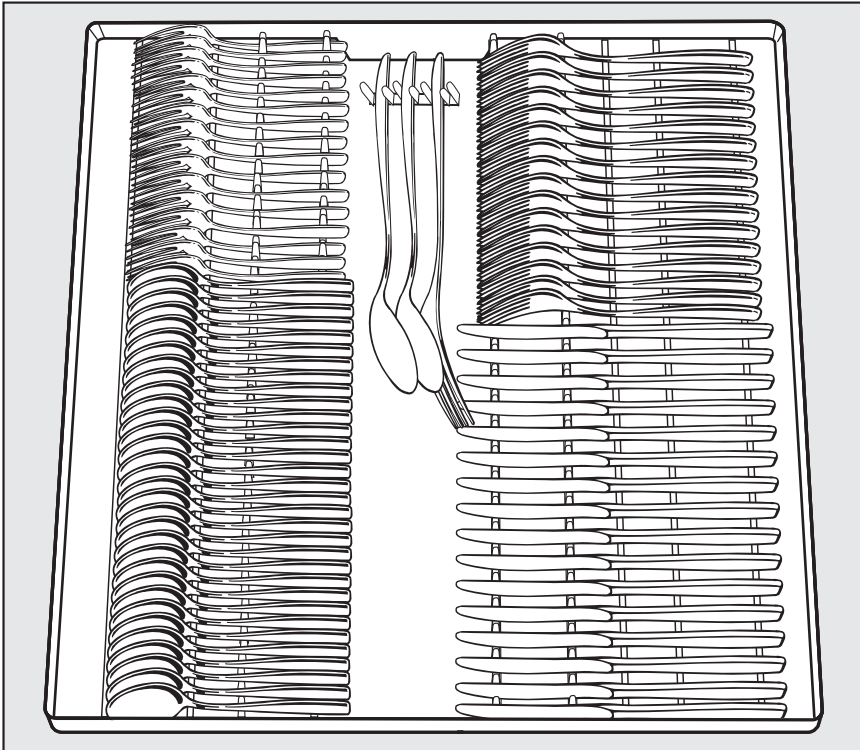

Cutlery tray

# Loading the dishwasher

## Upper basket

 Always use the dishwasher with the upper and lower basket in place.

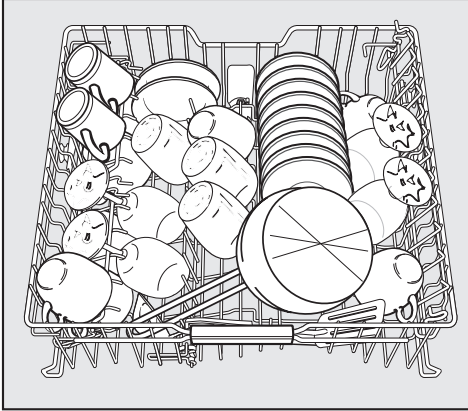

- Load the upper basket with small, lightweight, or delicate items such as cups, saucers, glasses, dessert bowls and flat pans.

Long items such as soup ladles, mixing spoons and long knives should be placed lying down across the front of the upper basket.

## Adjustable cup rack

(depending on model)

- Raise the rack to make room for tall glasses.

Glasses can also be leaned against the cup rack so they are more stable.

- Lower it to double stack smaller pieces.

# Loading the dishwasher

---

## Adjusting the upper basket

In order to gain more space for taller items the upper basket can be adjusted on three levels with 2 cm between each level.

The upper basket can also be set at an angle with one side high and the other side low. Make sure, however, that the basket can slide smoothly in and out of the cabinet.

- Slide out the upper basket.

To adjust the upper basket upwards:

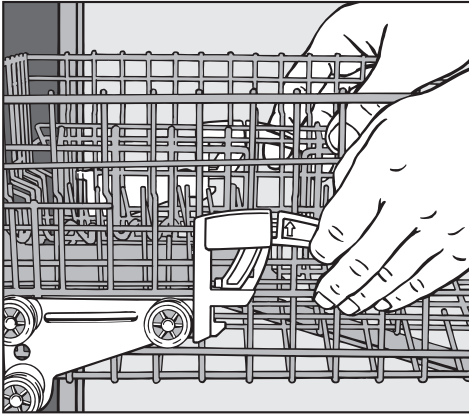

- Lift the basket up until it clicks into place.

To adjust the upper basket downwards:

- Pull up on the levers at the sides of the upper basket.
- Adjust the basket to the desired height and then release the levers to lock the basket in place.

Depending on the setting of the upper basket, the following plate dimensions can be accommodated.

Depending on the setting of the upper basket, a variety of plate dimensions can be accommodated.

# Loading the dishwasher

## Lower basket

- Place larger and heavier items such as plates, serving platters, saucepans, bowls, etc. in the lower basket. It can also be used for glasses, cups, small plates and saucers.

## Dishwasher with cutlery tray

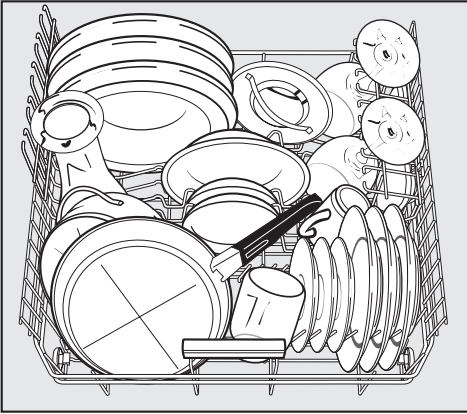

## Dishwasher with cutlery basket

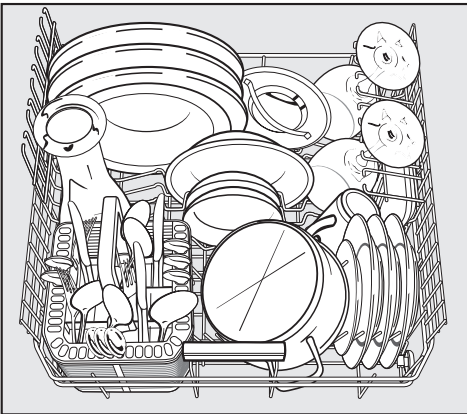

## Heavily soiled items

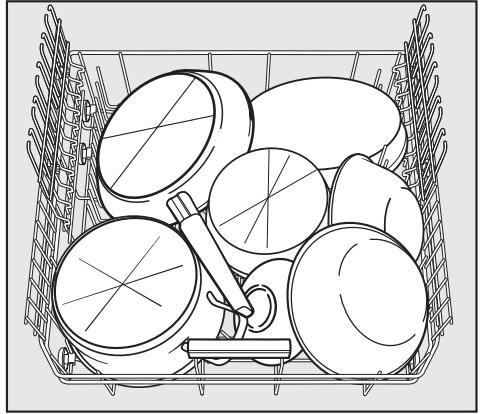

- Place very large plates in the center of the lower basket.

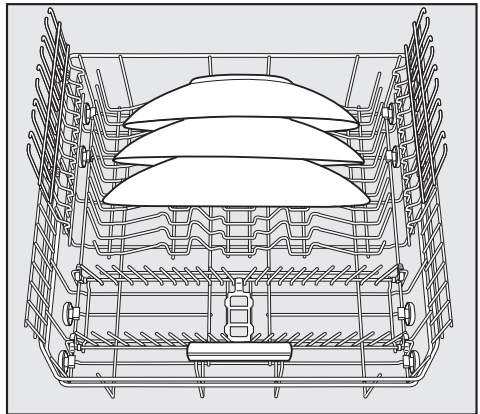

When tilted, plates up to 13 3/4" (35 cm) in diameter can be accommodated.

# Loading the dishwasher

## MultiComfort zone

The rear section of the lower basket is used for cups, glasses, plates, pots and pans.

- The glass rack can be folded up to make more room for tall items.
- Stemware, e.g. wine, champagne and beer glasses, can be leaned against the glass rack or suspended from it.

The height of the glass rack is adjustable.

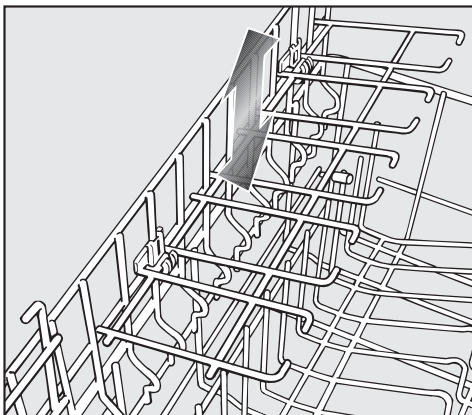

- Slide the glass rack to the desired height until the catches click into place at the top and rest on the bottom.

## Foldable spikes (depending on the model)

The spikes at the front are used for plates, soup bowls, platters, desert bowls, and saucers.

The rows of spikes can be folded down to create more room for larger cookware, e.g. pots, pans and bowls.

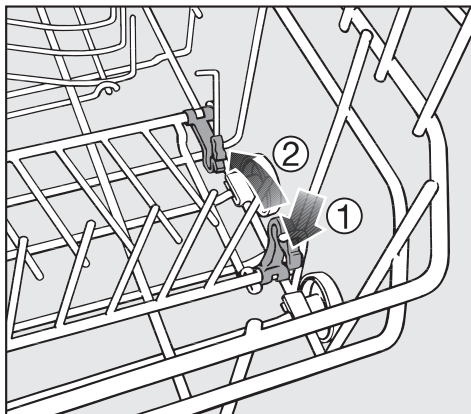

- Press the yellow lever down ① and fold the spikes down ②.

## Cutlery tray

(depending on model)

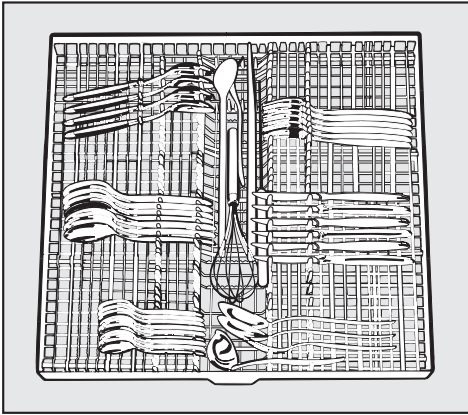

- Arrange the cutlery as shown in the cutlery tray.

For easier unloading cutlery should be grouped in zones, one for knives, one for forks, one for spoons, etc.

Place knives with the cutting edge down and forks with the prongs between the holders. Spoons should be placed in the opposite direction with the handles between the holders so that water can run off more easily.

The upper spray arm must not be blocked by tall cutlery items.

The cutlery tray insert is removable.

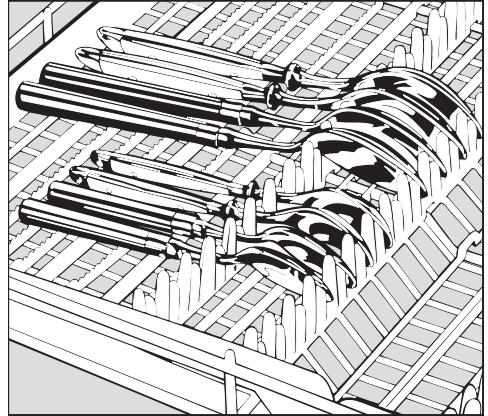

Spoons with thick handles may have to be placed as knives and forks with their heads in the holders.

# Loading the dishwasher

## Cutlery basket

(depending on model)

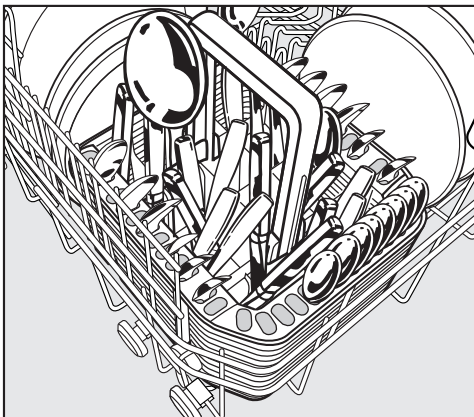

The cutlery basket can be placed anywhere on the front rows of spikes in the lower basket.

- To avoid risk of injury, knives and forks should be placed with the handles upwards in the basket. However, cutlery placed handle down in the basket will come out cleaner and drier.
- Place small items of cutlery in the individual slots on three sides of the cutlery basket.

## Cutlery insert for the cutlery basket

Use the insert supplied for heavily soiled items of cutlery. The insert separates the items so that they can be reached better by the spray jets.

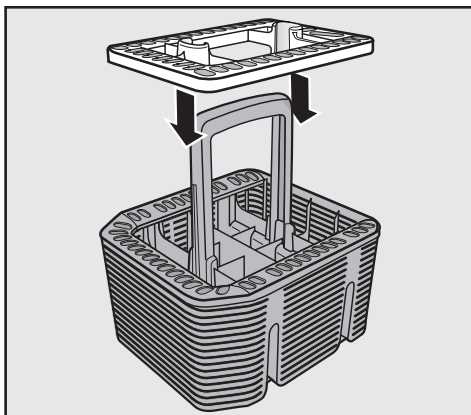

- Fit it onto the cutlery basket if required.

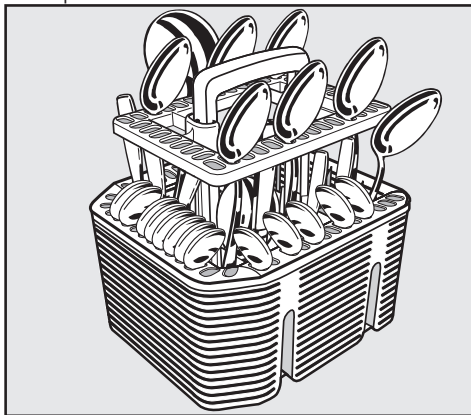

- Insert cutlery with the handles facing downwards, and distribute them evenly along the insert.

## Optional accessories

---

Optional dishwasher accessories are available from your Miele dealer, Miele or Mieleusa.com (depending on your model some may already be supplied with your machine as standard).

---

**If you would like to...****the following accessory will need to be ordered...**

---

...wash a Miele Cappuccinatore

... a Cappuccinatore insert for the upper basket.

---

...wash additional items of cutlery

... a cutlery basket for the lower basket.

---

...wash long-stemmed glassware

... a glassware rack for the lower basket.

### MieleCare Collection

Miele branded cleaning and care products, including dishwasher salt, detergent and rinse aid, are available to order from your Miele dealer, Miele or the on-line Miele store [www.mieleusa.com](http://www.mieleusa.com)

# Use

---

## Detergent

 Dishwasher detergents contain irritant and corrosive ingredients. Avoid inhaling or swallowing dishwasher detergent. Keep children away from detergent. Keep detergent out of the reach of children. Keep children away from the dishwasher when the door is open. There could still be detergent residues in the dishwasher. Only add detergent just before starting the program and lock the door with the child safety lock (depending on model).

 Only use detergents formulated for domestic dishwashers.

Use only the recommended amount of detergent. Continued use of too much detergent may cause machine damage.

When using the "China & Crystal" program (depending on model) reduce the amount of detergent used to at least  $\frac{1}{2}$  of the normal dosage. Also make certain your china and crystal are dishwasher safe.

You can use powder, gel or tab detergents. Follow the dosage information on the detergent packaging.

Detergent tabs are not recommended for use with the program "Express". The tabs may not dissolve completely.

Dishwasher cleaning products are available from Mlele.

## Adding detergent

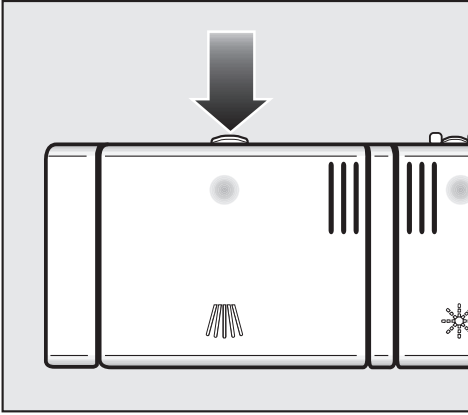

- Press the latch on the detergent dispenser. The flap will spring open.

The flap is always open at the end of a program.

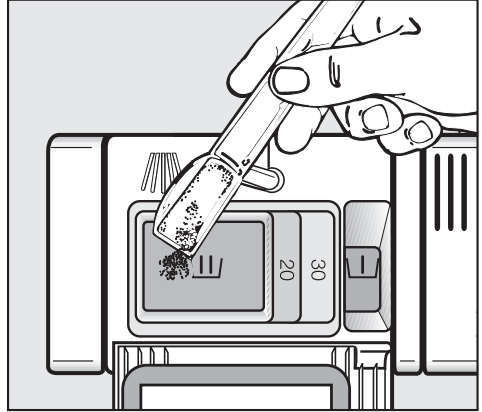

- Add detergent to the compartments and close the container flap.
- Use one tab or add powder or gel detergent to compartment II and close the flap.
- If a Pre-rinse is desired, and available for your chosen program, add 1 teaspoon (5 ml) of detergent to compartment I.

Compartment I holds a maximum of 2 teaspoons (10 ml), compartment II holds a maximum of 3.5 tablespoons (50 ml) of detergent.

The horizontal marks in compartment II indicate the levels of approximately 1 ¼ and 2 tablespoons (20 and 30 ml) respectively. The marks indicate the approximate fill level in ml when the door is open in a horizontal position.

# Use

---

## Turning the dishwasher on

- Open the water supply if it is closed.
- Open the door.
- Make sure the spray arms can rotate freely.
- Press the  button to turn the dishwasher on.

The  indicator light and the indicator light of the last selected program come on.

## Selecting a program

Choose the program according to the type of dishware and soiling.

See **Program guide** for a description of the programs and their applications.

- Use the Program button to select the desired program.

The indicator light for the selected program comes on.

The time display shows the runtime of the selected program in hours and minutes.

You can now select additional options (see Additional options).

If additional options are selected, the corresponding indicator lights will also come on.

## Starting a program

- Close the door to start the program.

Cancel a program only in the first few minutes.  
Otherwise important program steps (e.g. water softening) may be cancelled.

Program guide	When to use	Program sequence						
		Pre-rinse		Main wash	Interim rinse		Final rinse	Drying
		1	2		1	2		
Pots & Pans	For <b>normally soiled pots &amp; pans</b> with <b>dried on food</b> , and heavily soiled dishware, use 120% detergent recommended.	X		X	X		X	X
Normal	Program for completely washing a full load of <b>normally soiled</b> dishware with the ability to adjust energy and water consumption based on the soil load of the dishware.	as required		X	X		X	X
China & Crystal	For temperature sensitive glassware and lightly soiled dishware, <b>use 50% detergent recommended</b> .	as required		X	as required		X	X
SaniWash	To <b>sanitize dishware</b> , e.g. baby bottles, cutting boards and preparation dishware.			X		X	X	X
Express	"Quick program" for <b>lightly soiled</b> dishware, e.g. party dishware, not suitable for detergent tabs.			X	X		X	X
Rinse & Hold	To rinse dishes when a complete program is not needed.	X						

Usage:

Electrical: 0.01 - 1.23 kWh

Water: 1.1 - 5 gal (4 - 19 l)

# Use

---

## Time display

Before the program starts, the time display shows the runtime of the selected program in hours and minutes. The remaining time is displayed during the program.

The time that is displayed may vary for the same program. It depends on the temperature of the incoming water, the reactivation cycle, the type of detergent and the quantity and soiling of the dishes.

When a program is selected for the first time, the display shows an average program time for cold water.

With every program, the electronics correct the time according to the temperature of the incoming water and the size of the load.

## Standby

A few minutes after the last button is pressed or a few minutes after the end of the program the dishwasher will switch to Standby mode to save energy. The time display and the indicator lights are turned off and only the ① indicator light flashes slowly.

- Press the ① button if you want to turn the indicator lights back on.

If the dishwasher is not turned off after the program ends, after a few minutes in standby mode it will turn off completely (see "Additional options - Optimize Standby").

If Salt and/or Rinse aid or a fault is displayed, the dishwasher will not switch to Standby mode.

If you use a Tab detergent, you can deactivate the refill messages and let the dishwasher go into Standby mode (see "Before using for the first time"). However, fault messages cannot be turned off.

## At the end of a program

- Open the door slightly to check whether the program has finished.

The time display shows a **U**.

The program has not yet finished as long as the program indicator light is still flashing. Close the door again so that the program runs to the end.

If the Express program was selected, the drying fan will run for a few minutes after the program has ended.

- Open the door.
- Press the **⏸** button to turn the dishwasher off.
- The dishwasher will continue to use electricity until it is turned off with the **⏸** button.

**⚠** If you would like to open the door at the end of the program, then make sure that you open the door fully. Otherwise steam from the dishwasher could damage the edge of the counter top because the fan is no longer running.

- Unload the dishwasher.

Dishes tend to break and chip more easily when they are hot. Allow the dishes to cool until they are comfortable enough to handle before unloading them.

The dishes will cool much faster if you open the door when the program has ended.

Unload the lower basket first, then the upper basket and then the cutlery tray (depending on the model). This will prevent water from the upper basket and cutlery tray from dripping onto dishes in the lower basket.

## Preparing your appliance for an extended vacation

If you elect to turn off the water to your home for an extended period of time, please note that this may not be enough to reduce the risk of a leak.

To be completely safe, you must turn off the water supply to each individual appliance. This means under the sink for a dishwasher, at the laundry bib for your washer, etc.

# Use

---

## Interrupting a program

A program will be interrupted as soon as the door is opened. When the door is closed again, the program will continue from where it was interrupted.

 Water in the dishwasher is hot.  
Risk of scalding!  
Only open the door if absolutely necessary and be very careful. Before closing the door again, leave it slightly ajar for approx. 20 seconds. This will allow the temperature in the wash cabinet to settle. Then push the door firmly shut until it clicks into place.

## Changing a program

Do not change the program if the detergent dispenser flap is already open.

If a program has already started and you wish to change it:

- Open the door.
- Press the ① button to turn the dishwasher off.
- Press the ① button to turn the dishwasher back on.
- Use the Program button to select the desired program.
- Close the door to start the program.

### Turbo

The "Turbo" function can be used to reduce the program run-times, in programs in which the option is available.

Energy consumption will increase to achieve optimum results.

- Open the door.
- Press the  button to turn the dishwasher on.

The  indicator light comes on.

- Select a program.
- Press the Turbo button.

The Turbo indicator light will come on if the function is available for the program which has been selected.

- Start the program by closing the door.

Once selected, the function will remain active for all programs until the setting is changed.

## Additional options

---

### Delay start

The start time of a program can be delayed. The start time can be delayed from 30 minutes to 24 hours. The delay is set in 30 minute increments.

For a delay start time between 30 minutes and 9 hours 30 minutes, the delay is set in 30 minute increments. For a delay start time of 10 hours or more, the delay is set in increments of one hour.

When using the Delay start function, make sure that the detergent compartment is dry before adding detergent. Wipe dry if necessary. Otherwise the detergent could clump and not be rinsed out completely. Do not use liquid detergent. Liquid detergent could leak out of the compartment.

- Open the door.
  - Press the **⏻** button to turn the dishwasher on.
- The **⏻** indicator light comes on.
- Use the Program button to select the desired program.
  - Press the **⏻** button.

The last Delay start time will appear in the time display. The **⏻** indicator light comes on.

- Set the desired Delay start time using the **⏻** button.

If you keep the **⏻** button pressed, the time will increase automatically to **24h**. To start at 30 minutes again, press the **⏻** button twice.

- Close the door.

The time counts down to the program start: more than 10 hours, in 1 hour increments, less than 10 hours in 1 minute increments.

When the set time is reached, the selected program will start automatically. The remaining time is displayed, the **⏻** indicator goes out and the indicator light of the selected program comes on.

### Delay start time shown in the time display:

up to 59 minutes:  
e.g. 30 minutes = **30**

1 hour to 9 hours 30 minutes:  
e.g. 5 hours = **5.00**

more than 10 hours:  
e.g. 15 hours = **15h**

### Starting a program before Delay start has elapsed:

A program can be started before the Delay start time has elapsed. Do the following:

- Open the door.
- Press the **⏻** button to turn the dishwasher off.
- Press the **⏻** button to turn the dishwasher back on.
- Close the door to start the program.



### Buzzer

A buzzer sounds at the end of a program and when a fault occurs.

The buzzer at the end of a program sounds four times in intervals with a brief break in between.

The fault buzzer sounds four times in intervals without pausing.

The buzzer is activated by default. It can be turned off so that it does not sound at the end of a program. The buzzer for a fault cannot be turned off.

- Open the door.
- Press the  button to turn the dishwasher off.
- Press and hold the Program button and **simultaneously** turn the dishwasher on using the  button. Keep the Program button pressed for at least four seconds until the lower right program indicator lights up.

If it does not come on, start over.

- Press the Turbo button four times.

The Turbo indicator light shows 4 short flashes in intervals.

The flashing in the time display shows whether the program end buzzer is turned on or off:

- "P 1": buzzer is on
- "P 0": buzzer is off.

- Press the Program button if you wish to change the setting.

The setting is immediately saved.

- Press the  button to turn the dishwasher off.

# Additional options

---

## Optimize Standby

A few minutes after the last button is pressed or a few minutes after the end of the program the dishwasher will switch to Standby mode to save energy. The time display and the indicator lights are turned off and only the ① indicator light flashes slowly.

If the dishwasher is not turned off after the program ends, after a few minutes in Standby mode it will turn off completely.

You can also deactivate the Optimize Standby function. The time display and the indicator lights do not go out, and the dishwasher turns off 6 hours after the end of the program.

This results in higher energy consumption.

If Salt and/or Rinse aid or a fault is displayed, the dishwasher will not switch to Standby mode.

- Open the door.
- Press the ① button to turn the dishwasher off.
- Press and hold the Program button and **simultaneously** turn the dishwasher on using the ① button. Keep the Program button pressed for at least four seconds until the lower right program indicator lights up.

If it does not come on, start over.

- Press the Turbo button eight times.

The Turbo indicator light shows 8 short flashes in intervals.

The flashing in the time display shows whether Optimizing Standby is turned on.

- "P 1": Optimize Standby is on.
- "P 0": Optimize Standby is off.

- Press the Program button if you wish to change the setting.

The setting is immediately saved.

- Press the ① button to turn the dishwasher off.

### Factory defaults

If you have changed any settings, you can reset them to the factory defaults.

- Open the door.
- Press the ⏻ button to turn the dishwasher off.
- Press and hold the Program button and **simultaneously** turn the dishwasher on using the ⏻ button. Keep the Program button pressed for at least four seconds until the lower right program indicator lights up.

If it does not come on, start over.

- Press the Turbo button 12 times.

The Turbo indicator shows 1 long flash and 2 short flashes in intervals.

The flashing in the time display shows whether a setting is different from the default setting.

- "P 1": all values are set to the default settings.
- "P 0": at least one setting has been changed.



- Press the Program button to reset the dishwasher to the factory defaults.

The setting is immediately saved.

- Press the ⏻ button to turn the dishwasher off.

## Frequently Asked Questions

 Repairs should only be carried out by a qualified and trained person in accordance with local and national safety regulations. Unauthorized repairs could cause personal injury or machine damage.

<b>Technical faults</b>		
<b>Problem</b>	<b>Possible fault</b>	<b>Solution</b>
<b>The dishwasher will not start.</b>	The door is not properly closed.	Push the door firmly closed.
	The dishwasher is not plugged in.	Insert the plug.
	The circuit breaker has tripped.	<ul style="list-style-type: none"> <li>– Reset the circuit breaker (see data plate for the correct fuse rating).</li> <li>– If the circuit breaker trips again, contact Miele.</li> </ul>
	The dishwasher is not turned on.	Press the  button and select a program.
<b>The dishwasher stops during a program.</b>	The circuit breaker has tripped.	<ul style="list-style-type: none"> <li>– Reset the circuit breaker (see data plate for the correct fuse rating).</li> <li>– If the circuit breaker trips again, contact Miele.</li> </ul>
<b>The buzzer sounds. All the indicator lights of the program selection flash when the door is open. The time display shows fault FXX.</b>	There may be a technical fault.	Press the  button to turn the dishwasher off. After a few seconds: <ul style="list-style-type: none"> <li>– Turn the dishwasher on.</li> <li>– Use the Program button to select the desired program.</li> <li>– Close the door.</li> </ul> If the indicator lights flash again, there is a technical fault. <ul style="list-style-type: none"> <li>– Contact Miele,</li> </ul>
	<b>In addition, the drain pump may run even when the door is open.</b>	Fault F70: The waterproof system reports a fault.

## Frequently Asked Questions

<b>Faults in the water intake or water drain</b>		
<b>Problem</b>	<b>Possible fault</b>	<b>Solution</b>
<b>The dishwasher stops shortly after the program starts. The buzzer sounds. The Intake/Drain indicator light alternates between flashing and remaining steady when the door is open.</b>	The water supply is closed.	<ul style="list-style-type: none"> <li>– Open the water supply all the way.</li> </ul>
<b>The dishwasher has stopped. The buzzer sounds. The Intake/Drain indicator light flashes when the door is open. The time display shows fault FXX.</b>		<p>Before fixing the fault:</p> <ul style="list-style-type: none"> <li>– Press the Ⓛ button to turn the dishwasher off.</li> </ul>
	Fault F12/F13: Water intake fault.	<ul style="list-style-type: none"> <li>– Open the water supply all the way.</li> <li>– Clean the screen in the water supply valve (see User "Maintenance instructions").</li> <li>– The water pressure at the water connection is less than 4.35 psi. Consult a plumber.</li> </ul>
	Fault F11: Water drainage fault. There might be water in the wash cabinet.	<ul style="list-style-type: none"> <li>– Clean the triple filter (see "Cleaning and care").</li> <li>– Clean the drain pump (see "User maintenance instructions").</li> <li>– Clean the non-return valve (see "User maintenance instructions").</li> <li>– Remove any kinks or high loops in the drain hose.</li> </ul>

## Frequently Asked Questions

<b>General problems with the dishwasher</b>		
<b>Problem</b>	<b>Possible fault</b>	<b>Solution</b>
<b>The indicator lights and the time display are dark. Only the indicator light ① flashes slowly.</b>	The indicator lights and the time display turn off automatically to save energy (Standby).	Press the ① button to come out of Standby mode.
<b>There are detergent residues in the dispenser at the end of a program.</b>	The dispenser was wet when detergent was added.	Make sure the dispenser is dry before adding detergent.
<b>The detergent dispenser flap cannot be closed properly.</b>	Detergent residue is blocking the latch.	Remove the detergent residue.
<b>The inside of the door and/or the interior walls are wet after a program has finished.</b>	This is normal.	None. The moisture evaporates after a short time.
<b>There is water in the wash cabinet at the end of a program.</b>		Before fixing the fault: – Press the ① button to turn the dishwasher off.
	The triple filter in the wash cabinet is clogged.	Clean the triple filter (see "Cleaning and care").
	The drain pump or non-return valve is blocked.	Clean the drain pump or the non-return valve (see "User maintenance instructions").
	There is a kink in the drain hose.	Remove the kink.

## Frequently Asked Questions

<b>Sounds</b>		
<b>Problem</b>	<b>Possible fault</b>	<b>Solution</b>
<b>There is a knocking noise in the wash cabinet</b>	The spray arm is hitting an item in the basket.	Interrupt the program, rearrange items blocking the spray arms.
<b>There is a rattling noise in the wash cabinet</b>	Items are not secure in the wash cabinet.	Interrupt the program, and rearrange loose pieces.
	A foreign object has become lodged in the drain pump.	Remove the foreign object from the drain pump (see "Cleaning the drain pump and non-return valve")
<b>There is a knocking noise in the water line</b>	This may be caused by the installation or the diameter of the pipe.	This has no effect on the dishwasher. If in doubt, contact a plumber.

## Frequently Asked Questions

<b>Poor cleaning results</b>		
<b>Problem</b>	<b>Possible fault</b>	<b>Solution</b>
<b>The dishes are not clean.</b>	The dishes were not loaded correctly.	See "Loading the dishwasher".
	The program was not powerful enough.	Select a more intensive program (see "Program Guide").
	Not enough detergent was dispensed.	Use more detergent, or change the detergent.
	The spray arms are blocked.	Turn the spray arms and rearrange the dishes if necessary.
	The triple filter in the wash cabinet is clogged or not correctly inserted. The spray arm jets might be clogged as a result.	Clean the filter and insert it correctly. Clean the spray arm jets, if required (see "Cleaning and care").
	The non-return valve is stuck open and blocked. Wash water will run back into the wash cabinet.	Clean the drain pump and the non-return valve (see "Cleaning and care").
<b>Glasses and cutlery show streaks. There is a bluish sheen on the surface of glasses and a film which can be wiped off.</b>	The rinse aid dosage is set too high.	Reduce the dosage (see "Rinse aid").

## Frequently Asked Questions

<b>Problem</b>	<b>Possible fault</b>	<b>Solution</b>
<b>Dishes are not dry, glasses and cutlery are spotted.</b>	The rinse aid setting may be too low, or the rinse aid reservoir is empty.	Increase the dosage, refill the reservoir or switch the rinse aid product when refilling (see "Rinse aid").
	Dishes were taken out too soon.	Leave dishes in longer (see "Use").
	A "Tab" product was used. These products have a low drying effect.	Change the detergent, or refill the rinse aid (see "Rinse aid").
<b>White residue is visible on cutlery and dishes. Clouding occurs on glassware and cutlery; film can be wiped off.</b>	Not enough rinse aid was used.	Increase the dosage (see "Setting the rinse aid dosage").
	The salt container is empty.	Refill the salt container (see "Filling the salt container").
	The salt container lid was not correctly screwed on.	Reseat it making sure it screws back on correctly.
	Unsuitable "Tab" products were used.	Use a different detergent. Use normal (powder or gel) detergent.
	The water softener is programmed on too low a setting.	Program a higher water softener setting (see "Water softener").

## Frequently Asked Questions

<b>Problem</b>	<b>Possible fault</b>	<b>Solution</b>
<b>Glasses have a brown or blue discoloration; film cannot be wiped off.</b>	Detergent deposits.	Change detergent right away.
<b>Glasses are dull and discolored; film cannot be wiped off.</b>	Glasses are not dishwasher safe. The surface is affected.	There is no remedy. Only use dishwasher safe glasses.
<b>Tea or lipstick stains have not been completely removed.</b>	The wash temperature of the selected program was too low.	Select a program with a higher wash temperature.
	The detergent has a low bleaching effect.	Use a different detergent.
<b>Plastics are discolored.</b>	Natural dyes e.g. from carrots, tomatoes or ketchup may be the cause. Not enough detergent was used to break down natural dyes.	Use more detergent (see "Detergent"). Discoloration is permanent.
<b>There are rust stains on cutlery.</b>	The affected items are not corrosion resistant.	There is no remedy! Use only dishwasher safe cutlery.
	No program was run after refilling salt. Salt residuals got in the wash cycle.	Start the "Express" program without a load after refilling salt.
	The salt container lid was not screwed on properly.	Reseat it making sure it screws back on correctly.

### Repairs

In the event of a fault which you cannot correct yourself please contact the Miele Service Department at the phone number on the back of this booklet.

- Please quote the model type and number of your appliance.

These can be found on the data plate along the right edge of the door.

### PC Update

The Program Correction (PC) allows a technician to update the dishwasher to make use of new technology.

When, for example, technological developments offer advanced modifications to your existing program cycles a service technician will be able to input these into your machine controls via the indicator light marked PC. Miele will provide information when such possibilities become available.

### MieleCare

(USA only)

**MieleCare**, our Extended Service Contract program, gives you the assurance of knowing that your appliance investment is covered by 5 years of worry free ownership.

**MieleCare** is the only Extended Service Contract in the industry that guarantees repairs by a Miele Authorized Service Provider using genuine Miele parts. Only genuine Miele parts installed by factory trained professionals can guarantee the safety, reliability, and longevity of your Miele appliance.

Please note that unless expressly approved in writing by Miele's Service department, Extended Service Contracts offered by other providers for Miele products will not be recognized by Miele. Our goal is to prevent unauthorized (and untrained) service personnel from working on your Miele products, possibly doing further damage to them, you and/or your home.

To learn more about **MieleCare** Extended Service Contracts, please contact your appliance dealer or visit us online at:

**<http://mieleusa.com/mielecare>**



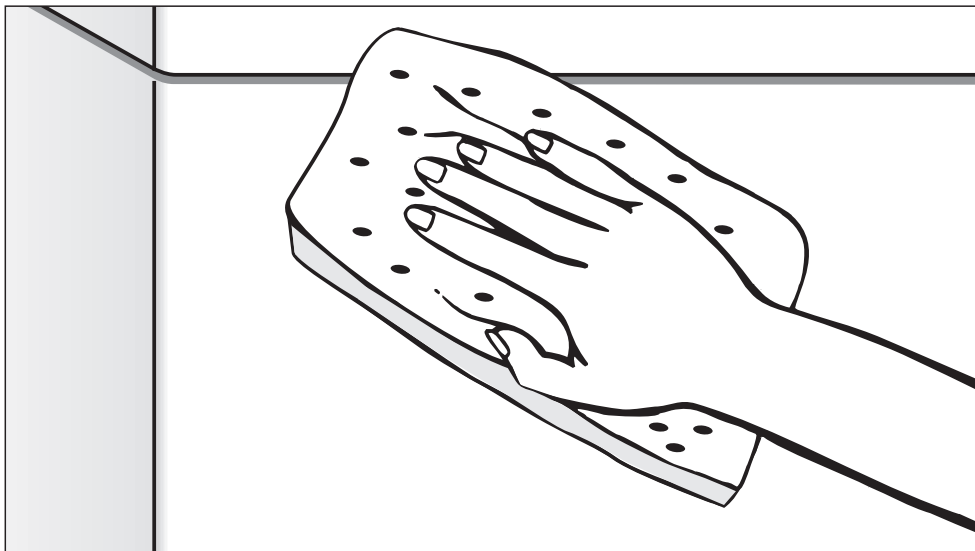

## User Maintenance Instructions

To prevent accidents  
and machine damage,  
read these instructions

**before**  
installation or use.

# Cleaning and Care

---

Check and clean your dishwasher regularly. This will help avoid faults and problems.

 Abrasive cleaning agents, all-purpose cleaners, thinner or ammonium cleaners should not be used on the dishwasher. They **will** damage the surface.

## Wash cabinet

Generally, the wash cabinet is self cleaning if the correct amount of detergent is used.

The wash cabinet can be cleaned with a dishwasher cleaner such as "Dis Cleaner" available from your Miele dealer or online at [www.mieleusa.com](http://www.mieleusa.com).

## Door and the door seal

- Wipe the door seals regularly with a damp cloth to remove food deposits.
- Food residue and spilled liquids should be wiped from the sides of the dishwasher door. These are outside of the wash cabinet and are not cleaned by water from the spray arms.

## Control panel

- The plastic control panels should only be wiped with a damp cloth or suitable cleaning agent designed for use on plastic.

 The appliance and front controls are not scratch proof. Remove spills immediately.

## Exterior

- Only use a conditioner suitable for your kitchen cabinetry.
- Clean wood with a damp cloth and wipe dry.

Clean the exterior with a solution of warm water and liquid soap applied with a soft sponge. Dry with a soft cloth.

Glass cleaners may be used to clean the exterior. However **do not** allow them to sit or puddle, this can cause damage to the surface.  
**Remove the cleaner promptly.**

## To prevent damage to your appliance avoid the following:

- cleaners containing soda, ammonia, thinners, or chlorides
- cleaners containing descaling agents or lime removers,
- abrasive cleaners,
- stainless steel cleaners,
- dishwasher soap (powder),
- caustic (oven) cleaners,
- scouring pads, steel wool, hard brushes,
- metal scrapers,
- steam cleaning products.

## Triple filter system

The triple filter system in the base of the wash cabinet prevents food from being redeposited on dishes. It also protects the circulation pump from damage caused by foreign objects (e.g. broken glass, bones). During normal use, the filter system is self-cleaning.

 The machine must not be used without all the filters in place!

- Check and clean the filter system periodically for any trapped or foreign objects.

The level of soiling and time it takes before the filters need cleaning will vary depending on your household usage.

- Turn off the dishwasher before cleaning.

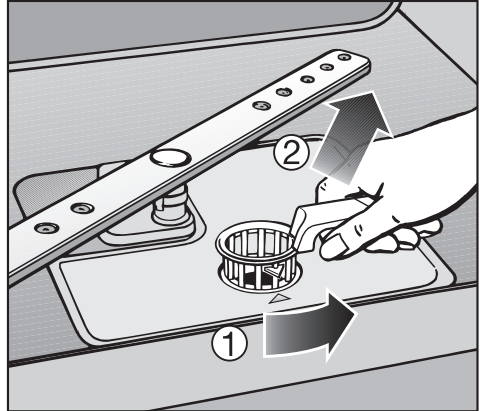

- Turn the handle counterclockwise to release the triple filter system ①.
- Lift the filter combination out of the machine ②. Remove any solid particles and rinse under running water. Scrub with a nylon brush if necessary.

## Cleaning and Care

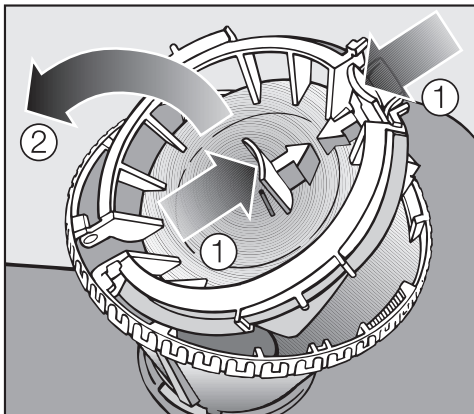

To clean the inside of the filter, the flap must be opened.

- Push the clips together ① and open the flap ②.
- Rinse under running water.
- Close the flap so that the clip engages.

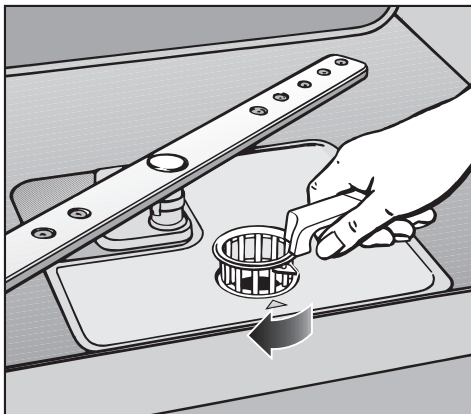

- Return the filter so it lies flat in the base of the wash cabinet.
- Lock the filter by turning the handle clockwise.

 The triple filter system must be inserted and locked into place. Large particles could get in the circulation system and cause a blockage.

## Cleaning the spray arms

Sometimes particles of food get stuck in the spray arm jets. The spray arms should be inspected and cleaned every 4 - 6 months.

- Turn off the dishwasher before cleaning.

## Removing the spray arms

- Remove the cutlery tray (if present).
- Push the **upper** spray arm up to engage the inner ratchet and unscrew the spray arm.

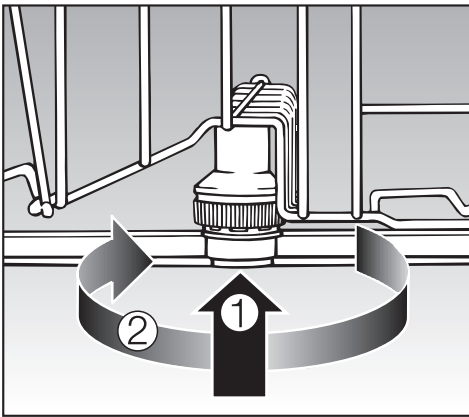

- Lift up the **middle** spray arm, ①, to engage the ratchet and unscrew the spray arm, ②.
- Remove the lower basket.

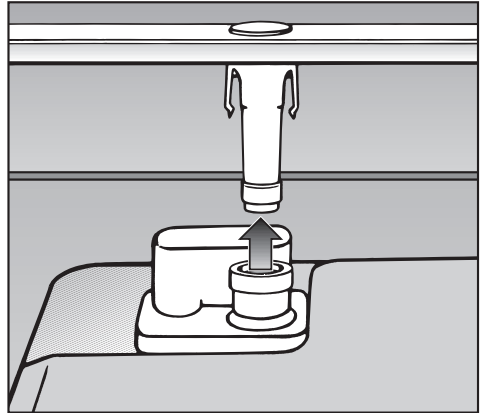

- Pull the **lower** spray arm firmly upwards to remove.

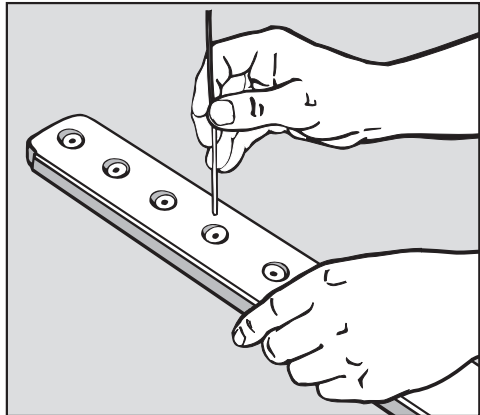

- Use a pointed object such as a toothpick to push food particles into the spray arm jets.
- Rinse thoroughly under running water.
- Return the spray arms and check that they rotate freely.

## Cleaning and Care

### Cleaning the drain pump and non-return valve

If the dishwasher is not completely drained at the end of a program, the drain pump or non-return valve may be blocked.

- Turn off the dishwasher and pull the plug.
- Remove the triple filter (see "Triple filter system").
- Use a cup or bowl to scoop water out of the wash cabinet.

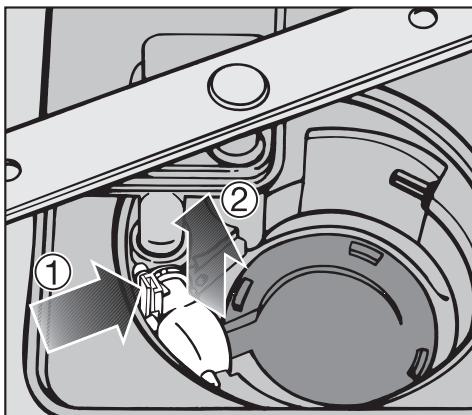

- Tilt the locking clamp to the side ①.
- Pull out the non-return valve ② and rinse it under running water.
- Remove all foreign objects from the non-return valve.

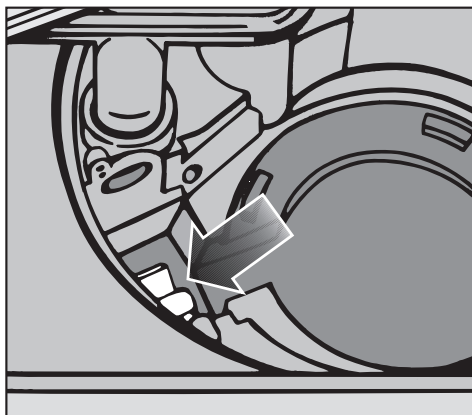

The drain pump is beneath the non-return valve (see arrow).

- Remove all foreign objects from the drain pump (glass or bone splinters).
- Before returning the non-return valve, check that the drain pump is not blocked. Spin the propeller several times in both directions to check for obstructions.
- Carefully reinsert the non-return valve and secure it with the locking clamp.

 Make sure the locking clamp clicks into place!

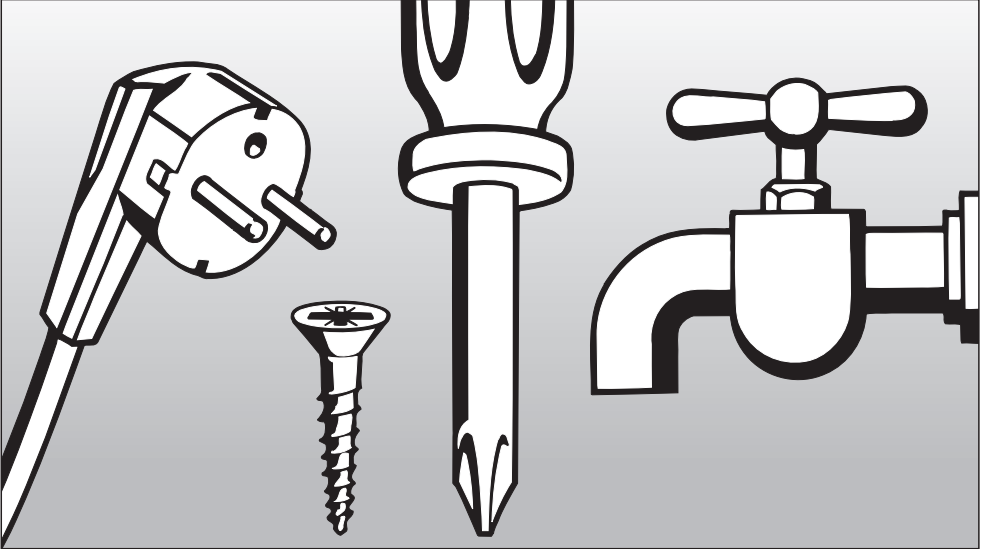

## Installation Instructions

Please refer to the Installation Diagram supplied with these instructions.

To comply with IEC sound testing protocols, please contact Miele for additional instructions.

Information is subject to change. Please refer to our website to obtain the most current product specification, technical & warranty information.

## Electrical connection

 Installation, repairs and other work by unqualified persons could be dangerous.

Check that the voltage, frequency and fuse rating shown on the data plate match the household mains supply.

The power outlet must be accessible after installation. Do not use an extension cord to connect the dishwasher to the mains. Danger of overheating! See data plate on the right side of the door.

A damaged power cord must only be replaced with a genuine Miele cord by a Miele service technician.

 **Improper connection of the equipment grounding conductor can result in electric shock. Do not modify the plug provided with the appliance; if it will not fit the outlet, have a proper outlet installed by a qualified electrician. If there is any question concerning the proper electrical connection or grounding of this appliance to the power supply, please consult a licensed electrician or call Miele's Technical Service Department:**

 1-800-999-1360

 1-800-565-6435

### GROUNDING INSTRUCTIONS

**THIS APPLIANCE MUST BE GROUNDED.**

In the event of a malfunction or breakdown, grounding will reduce the risk of electric shock by providing a path of least resistance for the electrical current. This appliance is equipped with a cord having an equipment grounding conductor and a grounding plug. The plug must be plugged into an appropriate outlet that is installed and grounded in accordance with all local codes and ordinances.

### Specifications

The dishwasher comes equipped with a 4 ft (1.2 m) power cord with a molded plug for connection to 120 V, 60 Hz, 15 A grounded receptacle.

# Electrical connection

## Hardwired electrical connection

It is possible to hardwire this appliance to an existing power cable.

**⚠ CAUTION:** Before servicing, disconnect the power supply by either removing the fuse, shutting off the power main or manually "tripping" the circuit breaker.

Installation work and repairs should only be performed by a qualified technician in accordance with all applicable codes and standards. Repairs and service by unqualified persons could be dangerous and the manufacturer cannot be held responsible.

Before connecting the appliance to the power supply, make sure that the voltage and frequency listed on the data plate correspond with the household electrical supply. This data must correspond to prevent machine damage. Consult an electrician if in doubt.

## GROUNDING INSTRUCTIONS

### **THIS APPLIANCE MUST BE GROUNDED.**

This appliance must be connected to a grounded metal, permanent wiring system, or an equipment-grounding conductor must be run with the circuit conductors and connected to the equipment-grounding terminal or lead on the appliance.

**⚠** Prior to making a hardwire connection to the terminal, remove the power cord. Otherwise there will be a risk of electric shock from the attached plug.

An existing flexible supply cord or cable shall have a minimum thickness of AWG 14.

120 V, 60 Hz, 15 A fuse rating

Black wire (live): connect to L

White wire (neutral): connect to N

Green wire (ground): connect to 

**⚠** After attaching the permanent power supply cord, check that all screws on the terminal block and the strain relief are tightened.

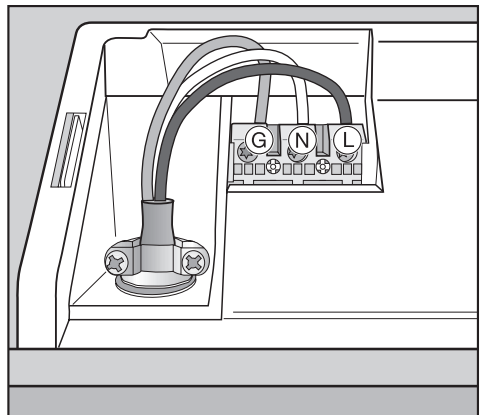

# Plumbing

---

## Connection to the water supply

 Installation, repairs and other work by unqualified persons could be dangerous.

 Do not drink water from the dishwasher!

- The dishwasher can heat its own water to the temperature required by the wash program. This allows for connection of the machine to either a hot (max. 140°F / 60°C) or cold water source.  
For lowest energy consumption and fastest possible wash times connect the dishwasher to a hot water source. All programs use hot water in the rinse cycles.
- The inlet hose is approximately 5 ft. (1.5 m) long.
- The water inlet hose comes equipped with an inlet hose ending with a 3/8" female compression fitting. This can be directly connected to a water supply valve or to an appropriate coupling.

If not connected directly to a water supply valve, an appropriate adapter (not included) is required.

- Water pressure: Must be between 4.5 - 145 psi (0.3 - 10 bar).
- If the water pressure is lower, a "Water Intake" notification will be shown. See "Frequently Asked Questions" for more information.
- If the water pressure is higher than shown, a pressure reducing valve must be used.

Ensure that the water connection is secure after the first use.

 To prevent damage to the dishwasher, it must only be connected to a fully vented drainage system.

 Do not cut the intake hose. If the hose is cut, the dishwasher will not work. There will be a water leak. If the hose is too long, coil it neatly and place it behind or under the machine.

## Drainage

- The machine comes equipped with a built-in non-return valve on the discharge side to prevent waste water from flowing back into the dishwasher.
- The dishwasher is equipped with a 5 ft (1.5 m) flexible drain hose with an internal diameter of 7/8" (22 mm).
- Drain hose extensions and adapters can be ordered from Miele. The maximum drain hose length is 13 ft. (4 m), max. drain height: 39" (1 m).
- Use the clamp provided to attach the hose to the dishwashers P trap or disposal connection (see the "Installation Diagram").

The hose must always be attached on the sink side of the P trap.

When attaching the hose to a garbage disposal fitting, make sure the plug which is normally blocking the fitting is knocked out or removed.

- The hose can be angled to the left or right side at the rear of the machine.
- The existing nipple that the drain hose is connected to may be designed for various hose diameters. If the nipple diameter is too large or too small it should be replaced or an adapter may be used. If the nipple extends more than 2" (50 mm) into the drain hose it should be shortened, or the hose could clog.

- The drain hose must not be shortened.

⚠ Make sure the hose is not kinked or cut when pushing the machine under the countertop.

## Venting the drainage system

If the dishwasher drain hose is connected to a floor drain or to a drain pipe that is less than 8" (20 cm) above the floor, the drain must be vented. Otherwise the water inside the dishwasher may siphon out during the wash program.

- Open the dishwasher door and remove the lower basket.
- Pull the lower spray arm firmly upwards to remove.

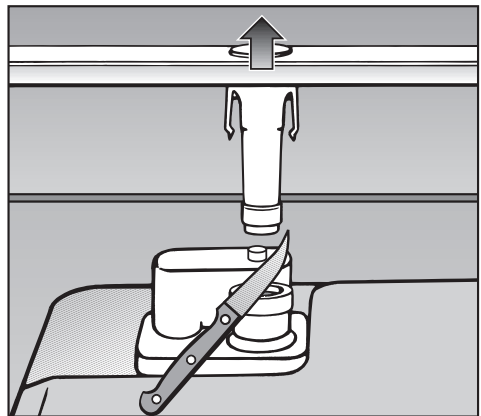

- Cut off the vent cap located at the right rear of the triple filter system, as illustrated.





**Please have the model and serial number  
of your appliance available before  
contacting Technical Service.**

---

The Miele logo is displayed in a bold, white, sans-serif font against a solid black rectangular background.

## **U.S.A. Miele, Inc.**

### **National Headquarters**

9 Independence Way  
Princeton, NJ 08540  
Phone: 800-843-7231  
609-419-9898  
Fax: 609-419-4298  
[www.mieleusa.com](http://www.mieleusa.com)

### **Technical Service & Support Nationwide**

Phone: 800-999-1360  
Fax: 888-586-8056

[TechnicalService@mieleusa.com](mailto:TechnicalService@mieleusa.com)

## **Canada Miele Limited**

### **Headquarters and Showroom**

161 Four Valley Drive  
Vaughan, ON L4K 4V8  
Phone: 800-643-5381  
905-660-9936  
Fax: 905-532-2290  
[www.miele.ca](http://www.miele.ca)  
[professional@miele.ca](mailto:professional@miele.ca)  
(commercial enquiries)

### **MieleCare National Service**

Phone: 800-565-6435  
905-532-2272  
Fax: 905-532-2292  
[customercare@miele.ca](mailto:customercare@miele.ca)  
(general and technical enquiries)



[www.miele-shop.com](http://www.miele-shop.com)

---

Alteration rights reserved / 4212  
G5280/G5285 /

Mi.-Nr. 09 510 220 / 01



INFORMATION IS SUBJECT TO CHANGE. PLEASE REFER TO OUR WEBSITE TO OBTAIN THE MOST CURRENT PRODUCT SPECIFICATIONS, TECHNICAL & WARRANTY INFORMATION.