

Product and Cut-out Dimensions G2000 Series Dishwashers

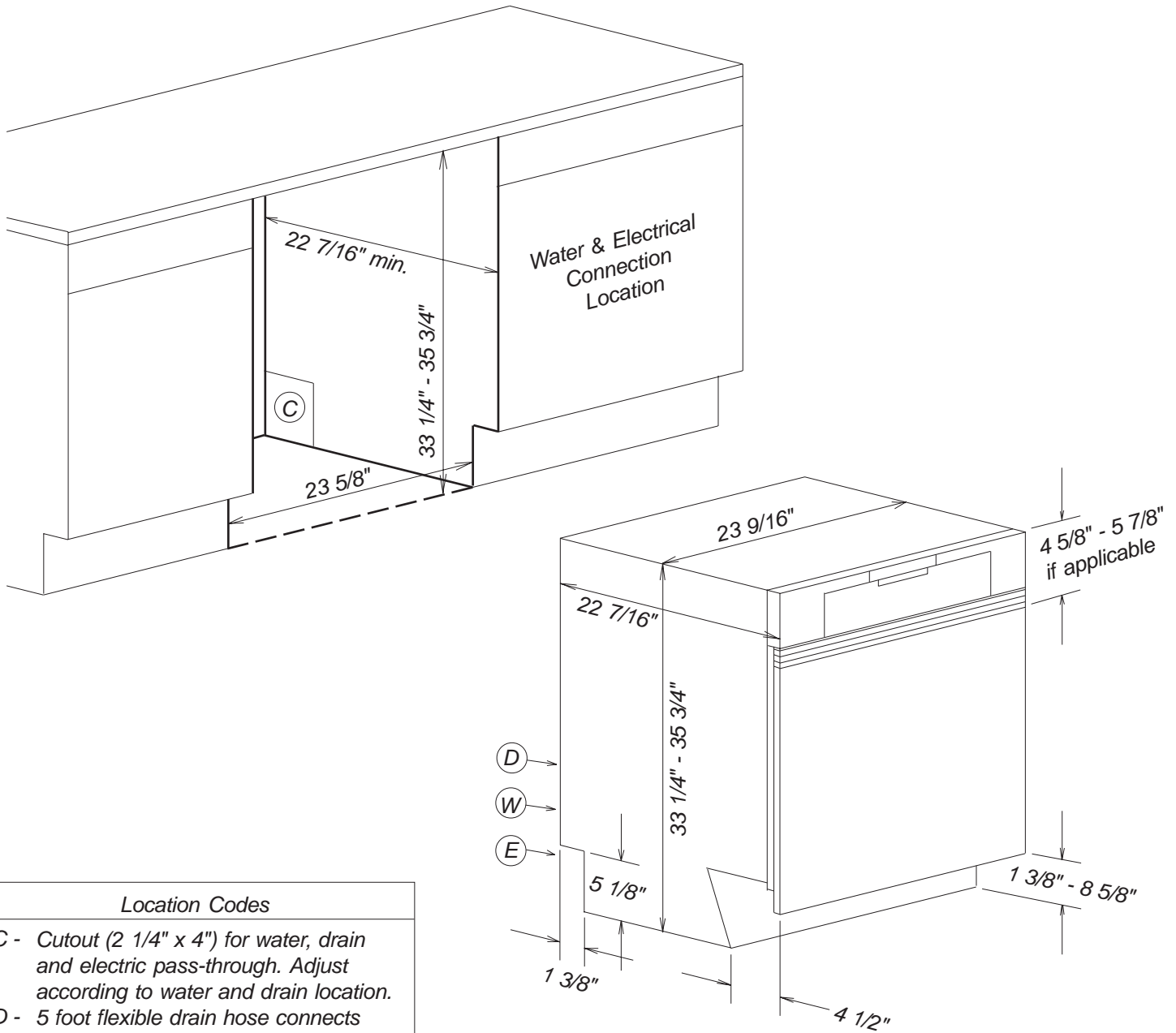

Location Codes
C - Cutout (2 1/4" x 4") for water, drain and electric pass-through. Adjust according to water and drain location.
D - 5 foot flexible drain hose connects lower center rear.
E - 5 foot - 120 Volt - 15 Amp 3-wire molded plug power supply connects lower left rear.
W - 5 foot "Double Waterproof" flexible water intake hose connects lower center rear.
Notes
• All installations must be done in accordance with local codes

NOTE: Drawing is not to scale.
SPECIFICATION SHEETS 010106

Front Panel Information

G2000 Integrated Models



Custom Panel Installations

Some Miele dishwashers do not come equipped with a front panel. These dishwashers are designed to accept a custom door panel supplied by the cabinet maker. Miele has a unique panel integration system which allows the dishwasher to align with the surrounding cabinets.

Panel size is determined in the following manner:

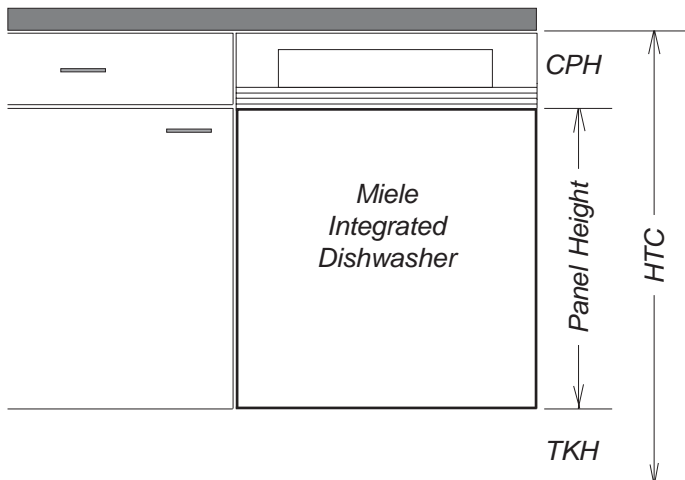

Width: 23 7/16" in all cases

Thickness: 3/4" in all cases

Height: Determined using the following calculation:

$$\text{Panel Height} = \text{HTC} - \text{CPH} - \text{TKH}$$

HTC = Height to the underside of countertop

CPH = Control panel height (Note 1)

TKH = Toe-kick height

Note 1: Control Panel Height is determined by the height of the drawers in the cabinets. This height is adjustable between 4 5/8" and 5 7/8" with spacer strips provided.

Maximum panel height: 27 1/4"

Minimum panel height: 21 1/4"

Maximum panel weight:

White / Black 23 Pounds

Stainless Steel 19 Pounds

GDU Kit Installations

In lieu of a custom front, Miele offers a decorative panel system called a GDU kit. GDU kits vary depending upon the model chosen. Each GDU kit contains a front panel and a toe-kick cover.

GDU 60/65-1

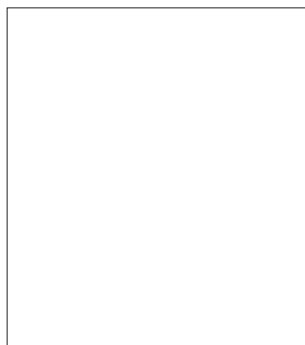

Exposed toe-kick

This GDU accepts a custom insert:

Height: 25 11/16"

Width: 23 1/8"



Thick: 1/8"

NOTE: Drawing is not to scale.
SPECIFICATION SHEETS 010106

Installation Information

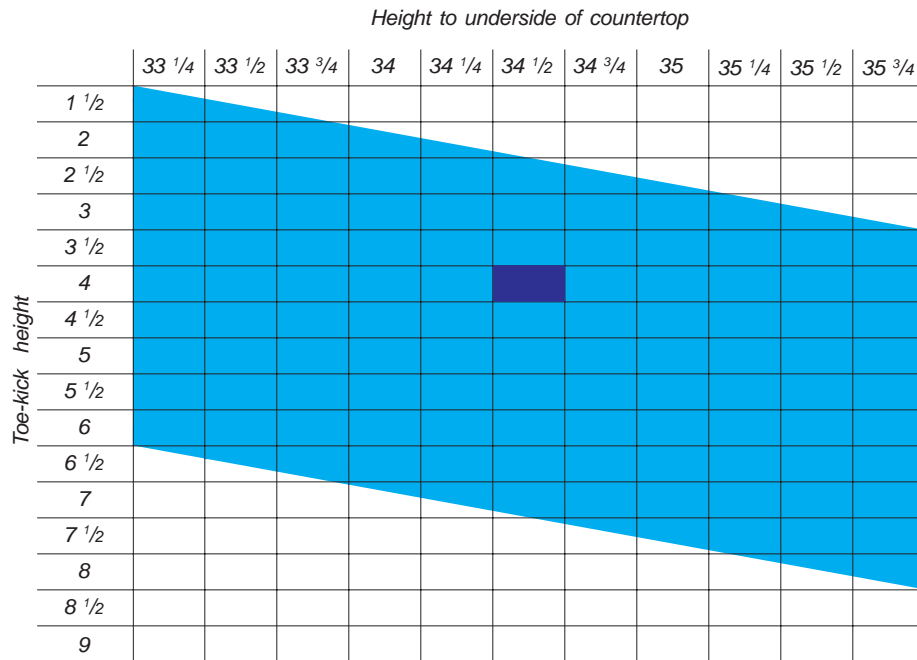
G2000 Dishwashers



 Acceptable combinations
 Typical American installation

Water Connection

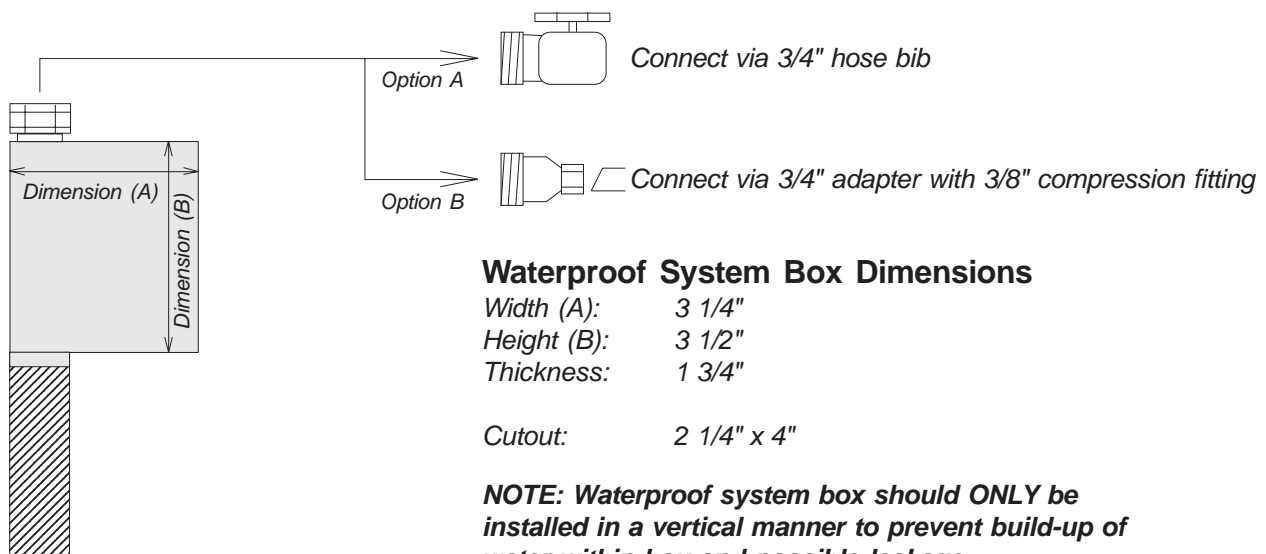

Waterproof System

Temperature: 110° - 130° F
 Pressure: 4.5 - 145 PSI
 Drain hose: 7/8" ID - 5 feet long

NOTE: Drawing is not to scale.
 SPECIFICATION SHEETS 010106