

FRIGIDAIRE

All about the

Use & Care

of your

Split Type Room Air Conditioner

AjMadison
Your Appliance Authority™

800-570-3355

Refer to Page 2 for table of contents.

Welcome to the world of simple handling and no worries

Thank you for choosing Frigidaire. This manual contains all of the information required to guarantee your safety and the appropriate use of your air conditioner.

Please read all of the instructions before using the air conditioner and keep this manual for future reference.

We know you will enjoy your new air conditioner and thank you for choosing our product.

We hope you will consider us for future purchase.

Environmental advices

The packaging material used is recyclable. We recommend that you separate plastic, paper and cardboard and give them to recycling companies. If you need to dispose of this appliance in the future, do NOT throw it away with the rest of your domestic garbage.



Attention

The air conditioner that you have bought may be slightly different from the one illustrated in this manual. Please refer to the information related to the model you have.

This air conditioner is for domestic use only. It is not recommended for commercial or industrial use.

Contents

01. Welcome.....	01
02. Environmental advices.....	01
03. Contents.....	02
04. Safety precautions.....	04
05. Installation:	
5.1 Choosing the installation site.....	07
5.2 Parts list.....	09
5.3 Indoor unit installation.....	11
5.4 Outdoor unit installation.....	15
5.5 Refrigerant piping connection.....	17
5.6 Electrical work.....	19
5.7 Air Purge.....	22
5.8 Electrical safety.....	25
5.9 Gas leak check.....	25
5.10 Test running.....	26
06. Operation:	
6.1 Preparing the device for operation.....	27
6.2 Product description.....	28
6.3 Remote control.....	30
- Remote control operation	
- Remote control specifications	
- Remote control battery	
- When should the batteries be replaced	
- To replace batteries	
- Remote control instructions	
6.4 Remote control description.....	32
- On/Off	
- Mode	
- +	
- -	
- Fan	
- 	
- TIMER ON	
- TIMER OFF	
- Clock	
- Blow	
- TEMP	
- Turbo	
- Sleep	
- LIGHT	
6.5 INTRODUCTION FOR SPECIALFUNCTION.....	33

6.6	How the air conditioner works.....	34
	- Automatic operation	
	- Cool/heat and fan only operation	
	- Dry operation	
	- Airflow direction adjustment	
	- Sleep mode	
	- Timer operation	
	- Optimal operation	
6.7	How to use the indoor unit.....	38
	- Adjusting air flow direction	
	- Adjusting the vertical air flow direction (up/down)	
	- To set the horizontal air flow direction (left/right)	
	- To automatically swing the air flow direction (up/down)	
6.8	Manual operation.....	40
07.	Maintenance.....	41
08.	Operation tips.....	43
09.	Solution for problems.....	45
10.	Major appliance 5 year parts only limited warranty.....	46



800-570-3355

Safety precautions

This appliance must be installed by a qualified licensed HVAC technician in accordance with all applicable codes. All electrical connections should be performed by a licensed electrician.

DANGER! Avoid Serious Injury or Death

1. Do not attempt to install the split air conditioner by yourself.
2. This air conditioner contains no user-serviceable parts. Always call an authorized Electrolux servicer for repairs.
3. When moving the air conditioner, always call an authorized Electrolux servicer for disconnection and re-installation.
4. Do not insert or place fingers or objects into the air discharge area in the front of the indoor unit.
5. Do not insert or place fingers or objects into the air discharge area in the outdoor unit.
6. Do not start or stop the air conditioner by unplugging the power cord or turning off the power at the electrical box.
7. Do not cut or damage the power cord.
8. If the power cord is damaged it should only be replaced by an authorized Electrolux servicer.
9. In the event of a malfunction (sparks, burning smell, etc.) immediately stop the operation, disconnect the power cord, and call an authorized Electrolux servicer.
10. Do not operate the air conditioners with wet hands
11. Do not pull on the power cord.
12. Do not drink any water that is drained from the air conditioners.

CAUTION! Avoid Injury or damage to the unit or other property

1. Provide occasional ventilation during use. Do not direct airflow at fireplaces or other heat related sources as this could cause flare ups or make units run excessively.
2. Do not climb on or place objects on the outdoor unit.
3. Do not hang objects off the indoor unit.
4. Do not place containers containing water on the indoor and/or outdoor units.
5. Turn off the air conditioner at the power source when it will not be used for an extended period of time.
6. Periodically check the condition of the outdoor unit's installation base for any damage.
7. Do not apply heavy pressure to the radiator fins of the indoor and/or outdoor units.
8. Operate the indoor unit with air filters in place.
9. Do not block or cover the intake grille, discharge area and outlet ports.
10. Ensure that any electrical/electronic equipment is one yard away from the indoor unit and outdoor unit.
11. Do not use or store flammable gases near the indoor and/or outdoor units.

To prevent injury to the user or other people and property damage, the following instructions must be followed.

Incorrect operation due to ignoring of instructions may cause harm or damage. The seriousness is classified by the following indications.

1. Connect with the power properly. Otherwise, it may cause electric shock or fire due to excess heat generation.
2. Always ensure effective grounding. No grounding may cause electric shock.
3. Disconnect the power if strange sounds, smell, or smoke comes from it. It may cause fire and electric shock.
4. Do not operate or stop the unit by switching on or off the power. It may cause electric shock or fire due to heat generation.
5. Do not operate with wet hands or in damp environment. It may cause electric shock.
6. Do not allow water to run into electric parts. It may cause failure of machine, electric shock or fire.
7. Do not use the power cord near flammable gas or combustibles, such as gasoline, benzene, thinner, etc. It may cause an explosion or fire.
8. Do not use the power cord close to heating appliances. It may cause fire and electric shock.



9. Do not damage or use an unspecified power cord. It may cause electric shock or fire.
10. Do not place heavy object on the power cord and ensure that the cord will not be compressed. There is danger of fire or electric shock.

11. Do not open the unit during operation. It may cause electric shock or injury.

12. Do not drink water drained from air conditioner. It contains contaminants and could make you sick.

13. Do not disassemble or modify unit. It may cause failure of appliance and electric shock.

14. When the air filter is to be removed, do not touch the metal parts of the unit. It may cause an injury.

15. When the unit is to be cleaned, switch off, and turn off the circuit breaker. Do not clean unit when power is on as it may cause fire, electric shock or injury.

16. Avoid direct exposure of occupants to air flow.

17. Turn off the main power switch when not using the unit for a long time.

18. The air conditioner may be dusted with an oil free cloth, or washed with a cloth dampened in a solution of warm water and mild dishwashing detergent. Rinse thoroughly and wipe dry. Wring excess water from cloth before wiping around controls.

19. Ensure that the installation bracket of the outdoor unit will not damage due to prolonged exposure. If bracket damages, there will be concern of damage due to falling of unit.

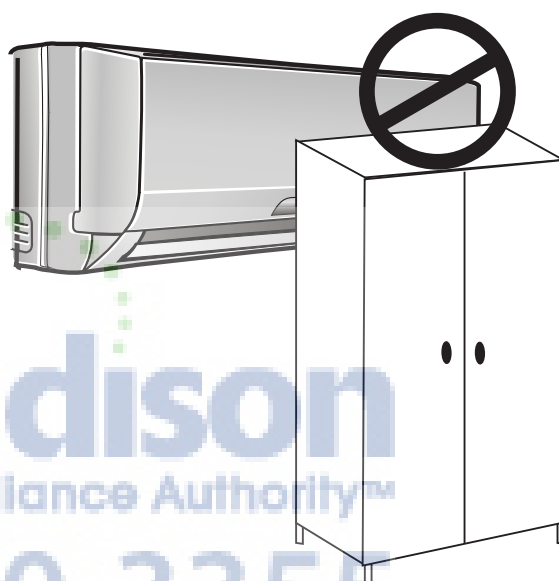
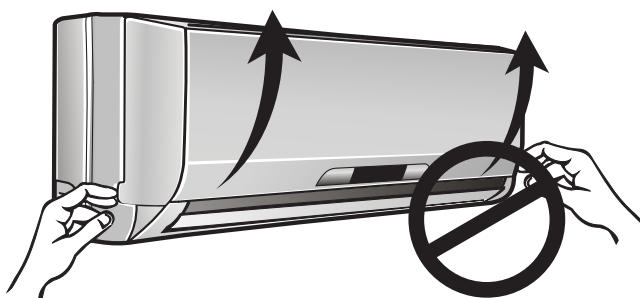

20. Always insert the filters securely. Clean filter once every two weeks. Operation without filters may cause failure.

21. Always install circuit breaker and a dedicated power circuit. No installation may cause fire and electric shock.

22. Do not place obstacles around air-inlets or inside of air-outlet. It may cause failure of appliance or accident.

Madison
Your Appliance Authority™
800-570-3355

Product description

- 1 Front panel
- 2 Air filter
(beneath front panel)
- 3 Horizontal airflow grille
- 4 Vertical airflow grille
- 5 Temperature sensor
(inside the indoor unit)
- 6 Panel
- 7 Infrared signal receiver
- 8 Refrigerant gas connector
- 9 Remote control
- 10 Connecting cable
- 11 Detection valve
- 12 Drain hose and refrigerant connecting pipe

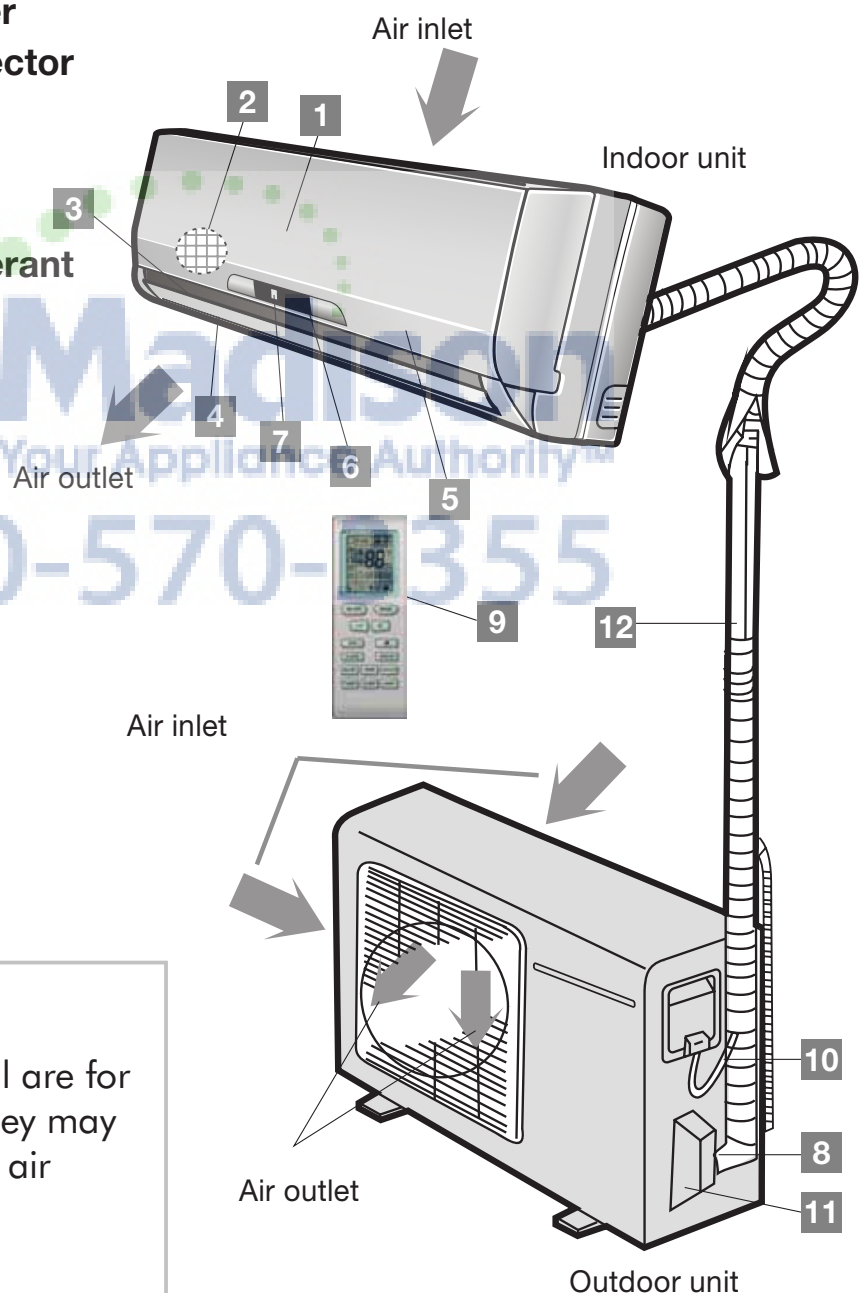

Attention

All the pictures in this manual are for explanation purpose only. They may be slightly different from the air conditioner you purchased.

Display panel (indoor unit)

13 HEAT indicator: This indicator illuminates when the air conditioner is in Heat operation

14 COOL indicator: This indicator illuminates when the air conditioner is in cool operation

15 DIGITAL SCREEN: Show the present adjustments to temperature when air conditioner is operating.

16 OPERATION indicator: This indicator illuminates red after power is on and illuminates green when the unit is in operation.

17 DRY indicator: This indicator illuminates when the air conditioner is in Dry operation

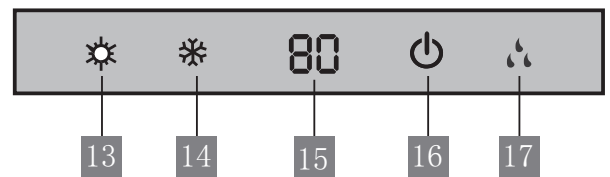
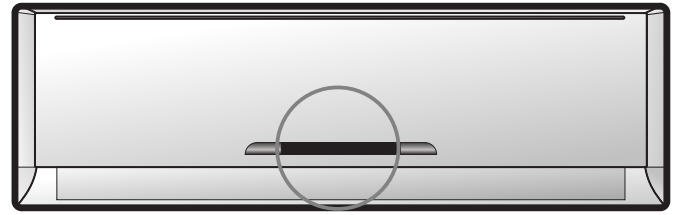

AjMadison
Your Appliance Authority™

800-570-3355

Attention

The description of the control is based on a typical model. The functions are the same in your air conditioner, even if there are some differences in the appearance.

Remote control

Remote control operation

1. Operation mode: Cool, Heat (Only for models with heating function), DRY, FAN, and AUTO (Automatic).
2. 24 hrs Timer.
3. Internal temperature range selection: 61°F - 86°F
4. LCD



REMOTE CONTROL SPECIFICATIONS

Rated voltage	3 V
Lowest voltage of CPU emitting signal	2.4 V
Transmission distance	32.8'*
Environment	23°F ~ 140°F
* With 3 V, reaches 40'	

Attention

1. The air conditioner will not operate when curtains, doors or other materials block the signals between the remote control and the indoor unit.
2. Avoid spilling any liquid in the remote control. Do not expose to sunlight or any heat source.
3. If the infrared signal receiver in the indoor unit is exposed to sunlight, the air conditioner unit might not work properly. Use curtains or shades to avoid having sunlight directly to the receiver.
4. If other electrical equipments react to the signals sent by the remote control, change their position or consult with you local dealer.

Remote control battery: To use the remote control, it is necessary to install two (R03/Ir03x2) alkaline AAA batteries.

When should the batteries be replaced

1. There is not a "beep" anymore from the indoor unit when using the control remote or the signal light indicator does not light.
2. The indoor unit does not respond to the remote control commands to activate the programs.

To replace batteries

1. Slide out the battery compartment cover (located at the back of the remote control).
2. Install two AAA batteries in the compartment (indicated in the drawing located inside the compartment).
3. Slide in the cover.
4. If the remote control is not operated for long period of times, batteries should be discarded.

Remote control instructions

1. The signal reach distance of the remote control to the receiver that is inside the indoor unit of the air conditioner is 32.8 ft. Any obstruction placed between the receiver and the remote control can cause interference, limiting the capacity of the programming.
2. Any time when a button is pressed on the remote control, the air conditioner emits a "beep" that indicates that a command has been received and transmitted to the indoor unit.

3. When selecting the function of timer, the remote control sends (automatically) a signal to the indoor unit at the specific period. If the remote control is left in a position that the signal is blocked, a 15 minute delay can be produced.

Attention

1. When replacing batteries, do not use old batteries or a different type battery. This may cause the remote control to malfunction.
2. If you do not use the remote controller for several weeks, remove the batteries. Otherwise battery leakage may damage the remote controller.
3. The average battery life under normal use is about 6 months.
4. Replace the batteries when there is no answering beep from the indoor unit or if the transmission indicator fails to light.

Remote control description

Cooling and heating model

1 ON/OFF: Press this button to start the unit operation. Push the button again to stop the unit operation.

2 MODE: Each time you press the button, a mode is selected in a sequence that goes from AUTO, COOL, DRY, FAN, and HEAT*, as the following figure indicates:



* Note: Only for models with heating function

3 +: Press the button to increase the indoor temperature setting.

4 -: Press the button to decrease the indoor temperature setting.

5 FAN: This button is used for setting Fan Speed in the sequence that goes from AUTO,

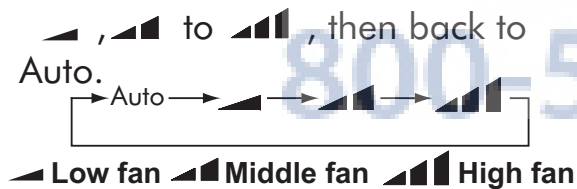

6 Fan Speed: Press this button, to set up swing angle and swing range, which circularly changes as below:

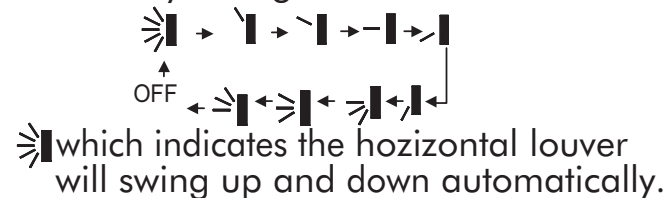





7 TIMER ON: Press this button to initiate the auto-on timer. To cancel the auto-timer program, simply press this button again.



8 TIMER OFF: Press this button to initiate the auto-off timer. To cancel the auto-timer program, simply press the button again.

9 CLOCK: Press this button, the clock can be set up, icon (⌚) blinks. Within 5 seconds, the value can be adjusted by pressing "+" or "-" button, if continuously press this button for 2 seconds above, in every 1/2 seconds, one minute will be increased, if you are still pressing the button after ten minutes increased, ten minutes will be increased every 1/2 seconds. During blinking, repress the Clock button, icon (⌚) will be constantly displayed and it denotes the setting succeeded

10 BLOW: When in cool or dry mode, press "BLOW" button to active or deactivate blow function ,the icon  will display and the indoor fan will continually run for 10 minutes in order to dry the indoor unit even though you have turned off the unit.

11 TEMP:When pressing "TEMP" button, there may be 3 optional icon display: , , .But only  is effective. The display panel will indicate ambient temperature for 5 seconds.

12 TURBO:Press this button to activate /deactivate the Turbo function which enables the unit to reach the preset temperature in the shortest time. In cooling mode, the unit will blow strong cooling air with super high fan speed. In heating mode, the unit will blow strong heating air with super high fan speed.

13 SLEEP: Press this button to go into the SLEEP operation mode. Press it again to cancel. This function only can be used in COOL, HEAT (Only for models with heating function) or DRY mode, and maintain the most comfortable temperature for you. To cancel SLEEP program,press this button again.

14 LIGHT:Turn the unit LED light on or off only.

INTRODUCTION FOR SPECIAL FUNCTION

1.ABOUT LOCK

Press "+" and "-" buttons simultaneously to lock or unlock the keypad. If the remote controller is locked, the icon will be displayed on it, in that case, press any button, the mark will  flicker for three times. Repress the combination to unlock.

2.About switch between Fahrenheit and Centigrade

Under status of unit off, press "MODE" and "-" buttons simultaneously to switch $^{\circ}\text{C}$ and $^{\circ}\text{F}$.

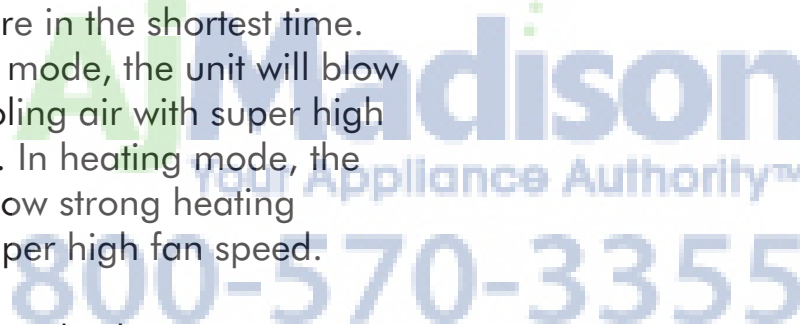
 Madison
Your Appliance Authority™
800-570-3355

How the air conditioner works

Automatic operation



When the Air Conditioner is ready for use, switch on the power and the OPERATION indicator lamp on the display panel of the indoor unit starts illuminating.

1. Use the MODE button to select AUTO.
2. Use the "MODE" button to select Auto. The unit will automatically select Cool, Fan and Heat operation depending on the difference ambient temperature and system difference temperature .When in Cool Operation the panel will display 77°F. In Fan Operation the panel will display 77°F In Heat Operation the panel will display 68°F.
3. Press the ON/OFF button again to stop the unit operation.

Attention

1. When you set the air conditioner in AUTO mode, it will automatically select cooling, heating(only for models with heating function) or fan only operation depending on the room temperature.
2. If the AUTO mode is uncomfortable, you can select desired conditions manually.

COOL / HEAT and FAN ONLY operation

1. If the AUTO mode is not comfortable, you may manually override the settings by using COOL, HEAT* or FAN ONLY** mode.
2. Press the "+"/"-" button to set the desired room temperature. When in COOL mode, the most comfortable settings are 70°F or above. When in HEAT mode, the most comfortable settings are 82°F or below.
3. Press the FAN to select the FAN mode of AUTO,  ,  or .
4. Press the ON/OFF button, the operation lamp lights and the air conditioner start to operate as your settings. Press the ON/OFF button again to stop this unit operation.

* Note: Only for models with heating function

**Note: The FAN ONLY mode can not be used to control the temperature. While in this mode, only steps 1,3 and 4 may be performed.

DRY operation

The dry mode will automatically select the drying operation based on the difference between the set temperature and the actual room temperature.

The temperature is regulated while dehumidifying by repeating turning on and off of the cooling operation or fan only. The fan speed is mainly LOW.

1. Press the MODE button to select DRY.
2. Press the "+" / "-" button to set the desired temperature from 61°F to 86°F.
3. Press the ON/OFF button, the operation lamp lights and the air conditioner starts to operate in the DRY mode. FAN SPEED is Low. Push the ON/OFF button again to stop this unit operation.

Attention

Due to the difference between the set temperature of the unit and the actual indoor temperature, the Air Conditioner in DRY mode will automatically switch the operation modes between COOL and FAN ONLY many times.

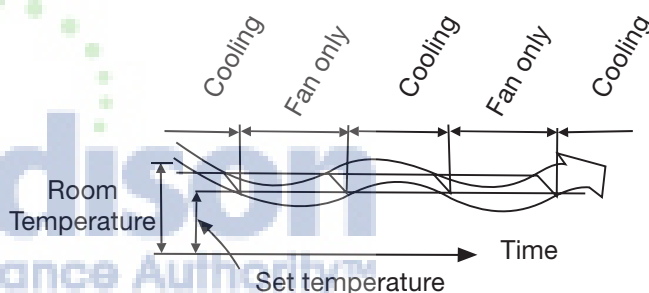

DRY FUNCTION

Air flow direction adjustment

Use  button to adjust the airflow direction up and down.

When  button is pressed, the horizontal louver moves up and down automatically. Press again to stop operation.

Attention

If the louver oscillates or moves in a position that could affect the cooling or heating (only for models with heating function) of the air conditioner, the direction of the oscillation/movement would alter automatically.

SLEEP mode(Only for > 12000 Btu's)

Press the sleep button to activate the sleep mode. To deactivate, press the button again.

In cooling mode:

- The fan speed will be automatically controlled
- The air conditioner will automatically increase 2°F per hour in a 2 hour period. The set temperature will be steady for the next 5 hours, then this mode will be terminated.

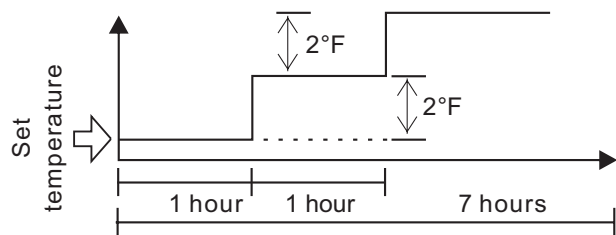

SLEEP FUNCTION (Cooling mode)

In heating mode (only for models with heating function):

- The fan speed will be automatically controlled
- The air conditioner will automatically decrease 2°F per hour in a 2 hour period. The set temperature will be steady for the next 5 hours, then this mode will be terminated.

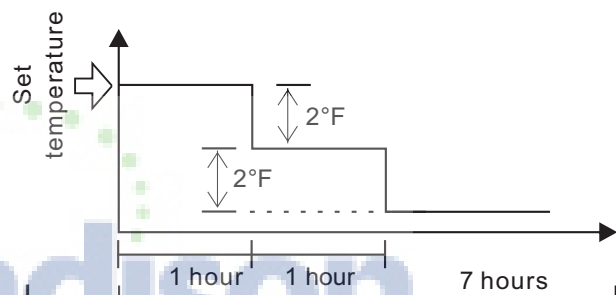

SLEEP FUNCTION (Heating mode)

TIMER Operation

TIMER button can set the auto-on time of the unit.

To set the starting time

1. Press the "TIMER ON" button to activate the auto start timer function . Auto start can be set from 0~24 hours. After pressing "TIMER ON" button, "ON" on the display will blink, and during 5 seconds blinking ,the value can be adjusted by pressing "+" or "-" button. Every press of this button, 1 minute will be increased or decreased, but continuously press the "+" or "-" button, 2 seconds later the value will be increased or decreased automatically ,and after 10 minutes increase or decreased, the value will be changed 10 minutes every 0.5 second; Press the "TIMER ON" button to conform the time.
2. when repressing the "TIMER ON" button , the "TIMER ON" setting will be canceled.

To set the stopping time

1. Press the "TIMER OFF" button to activate the auto start timer function.
2. The method of setting is the same as above of "TIMER ON".

Examples:

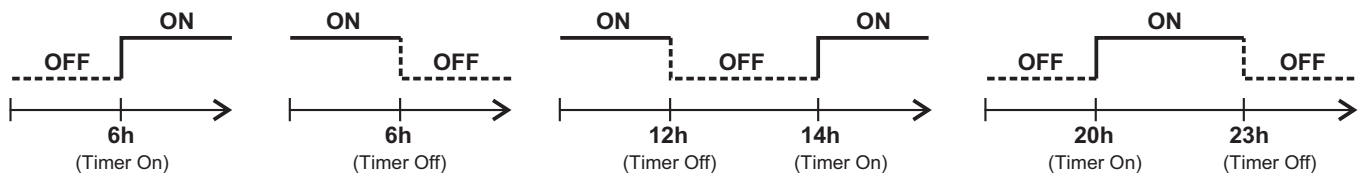

Optimal operation

To achieve optimal performance, please note the following:

1. Adjust the air flow direction correctly so that it is not directed on people.
2. Adjust the temperature to achieve the highest comfort level. Do not adjust the unit to excessive temperature levels.
3. Close doors and windows on COOL or HEAT(only for models with heating function)mode, or performance may be reduced.
4. Use TIMER ON button on the remote controller to select a time you want to start your air conditioner.
5. Do not put any object near air inlet or air outlet, as the efficiency of the air conditioner may be reduced and the air conditioner may stop running.
6. Clean the air filter periodically, otherwise cooling or heating(only for models with heating function) performance may be reduced.
7. Do not operate unit with horizontal louvre in closed position.

800-570-3355

How to use the indoor unit

Adjusting air flow direction

Adjust the air flow direction properly otherwise, it might cause discomfort or cause uneven room temperatures. Adjust the horizontal louver using the remote controller. Adjust the vertical louver manually.

To set the horizontal air flow direction (left/ right)

Adjust the vertical louver manually using the lever on the left or right side of the vertical louver arm (Depending on the specific model you choose), or move the lever at the left(or right, or middle which is only for 21500 Btu's, depending on the specific model you choose) end of the air outlet to the desired position. Perform these adjustments before you start the unit because once it has been started, there is risk of your fingers getting caught on the fan.



To automatically swing the air flow direction (up/down)

Perform this function while the air conditioner is in operation.

Press the  button on the remote controller.

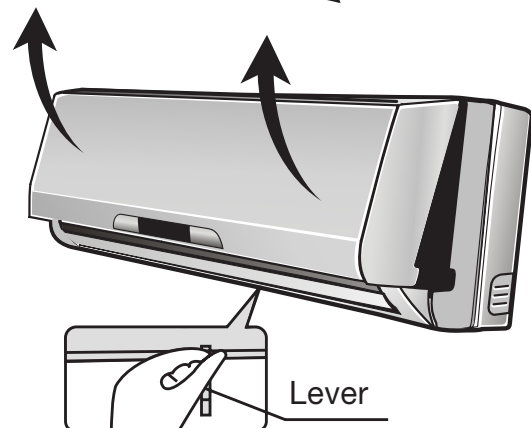
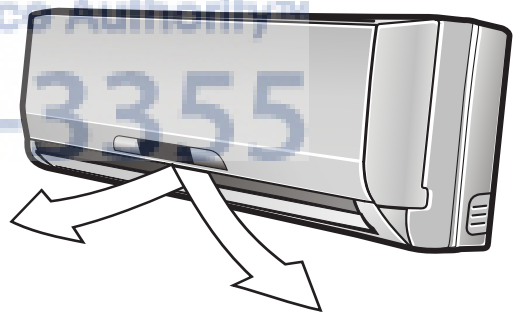
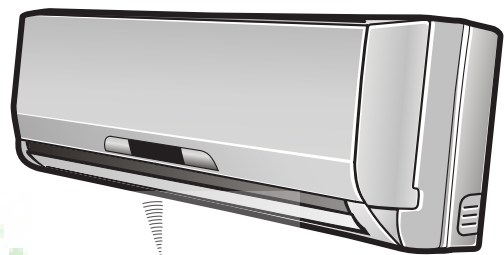
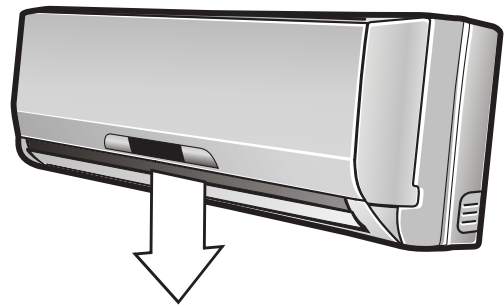
To stop the function, press the  button again.



- Press  to lock louver in desired position.
- The  button will be disabled when the air conditioner is not in operation (including when the TIMER ON is set).
- Do not operate the air conditioner for long periods with the air flow direction set downward in cooling or dry mode. Otherwise, condensation may occur on the surface of the horizontal louver and drop on to the floor or on furnishings.
- Do not move the horizontal louver manually. Always use the  button. If you move this louver manually, it may malfunction during operation. If the louver malfunctions, stop the air conditioner and restart it.
- Open angle of the horizontal louver should not be set too small, as COOLING or HEATING (only for models with heating function) performance may be impaired due to too restricted air flow area.
- Do not operate unit with horizontal louver in closed position.
- When the air conditioner is connected to power (initial operation), the horizontal louver may generate a sound for 10 seconds, this is a normal operation.

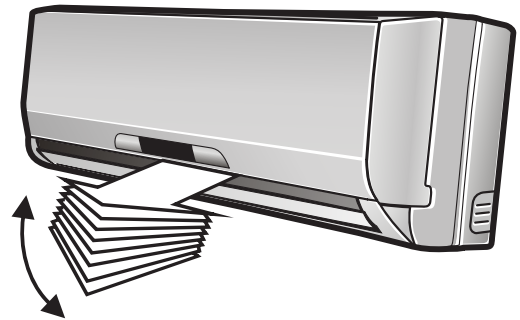

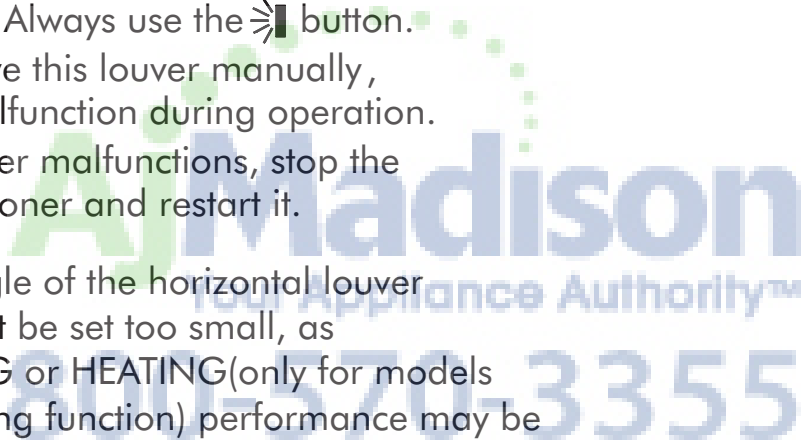

 AirMadison

 The Appliance Authority™

 800-570-3355

Manual operation (without remote control)

Manual operation can be used temporarily in case you can not find the remote controller or its batteries are exhausted.

1. Open and lift the front panel up to an angle until it remains fixed with a clicking sound.
2. One press of the manual control button will lead to the forced AUTO operation.
3. Close the panel firmly to its original position.

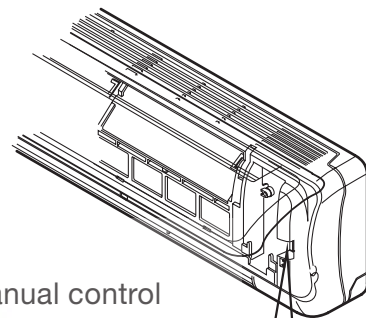
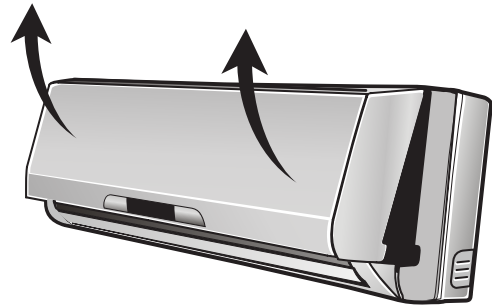

Manual control button

Auto/OFF ○

Attention

Once you press the manual button, the operation mode is shifted in an order as: AUTO and OFF.

The manual operation is mainly used for testing purpose. Do not choose it unless it is necessary. To return to the remote controller operation, use the remote controller

Maintenance

Cleaning the indoor unit and remote controller

1. It is necessary to stop the air conditioner and disconnect the power supply before cleaning.
2. Use a dry cloth to wipe the indoor unit and remote controller.
3. A cloth dampened with cold water may be used on the indoor unit if it is very dirty.
4. The front panel of the indoor unit can be removed and cleaned with water. Then wipe it with a dry cloth.
5. Do not use a chemically treated cloth or duster to clean the unit.
6. Do not use benzine, thinner, polishing powder, or similar solvents for cleaning. These may cause the plastic surface to crack or deform.

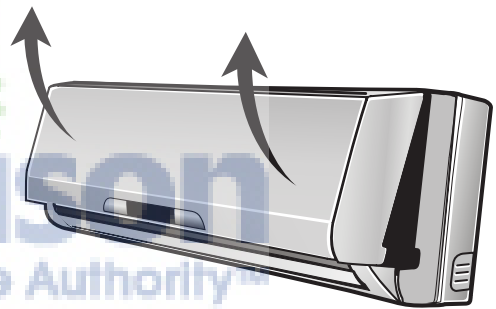

Cleaning the air filter

A clogged air filter reduces the cooling efficiency of this unit. Please clean the filter once every 2 weeks.

1. Lift the indoor unit panel up to an angle until it stops with a clicking sound.
2. Take hold of the handle of the air filter and lift it up slightly to take it out from the filter holder, then pull it downwards.
3. Remove the air filter (Fresh air filter if so equipped + support frame) from the unit.
4. If so equipped, remove fresh air filter from the support frame.
5. Clean the fresh air filter (if so equipped) at least once a month, and replace every 4 to 5 months. Use a vacuum cleaner, then dry.
6. Clean the support frame using a vacuum cleaner or water. Then dry

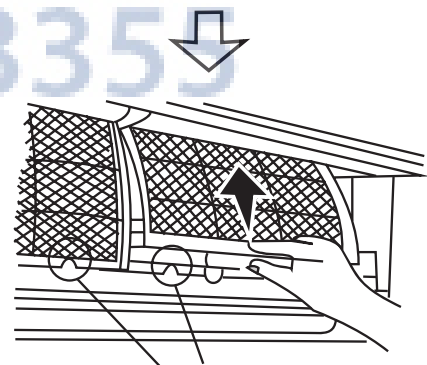

air filter

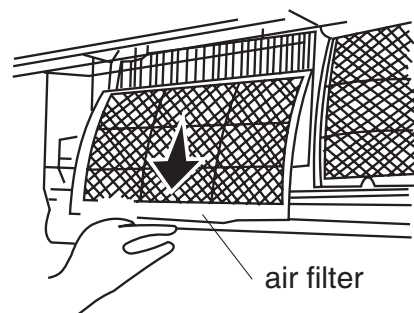

air filter

for a couple of hours.

7. Insert the fresh air filter(if so equipped) in its original place.
8. Insert the upper part of the air filter (Fresh air filter if so equipped + support frame) back into the unit keeping in mind that the outside border (right and left) are lined up correctly, then place the whole filter in its initial position.

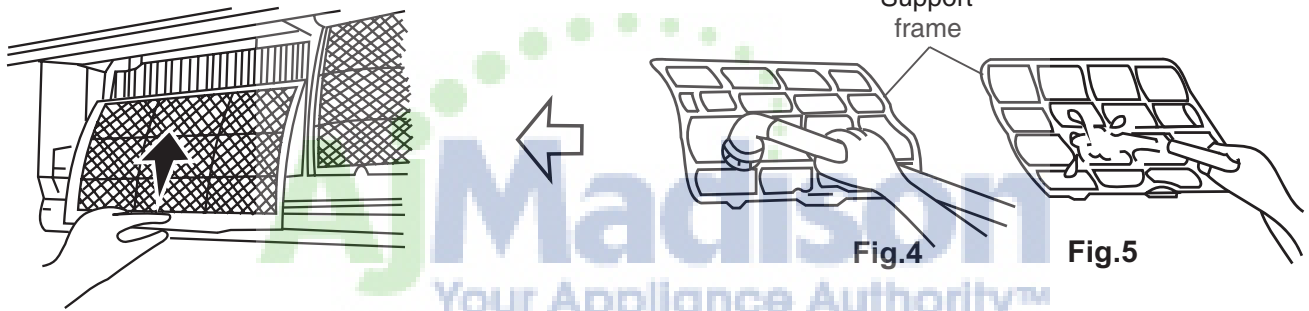
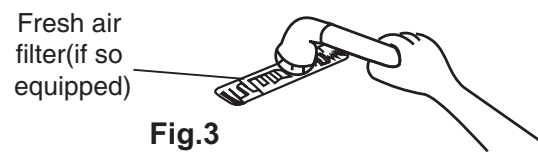
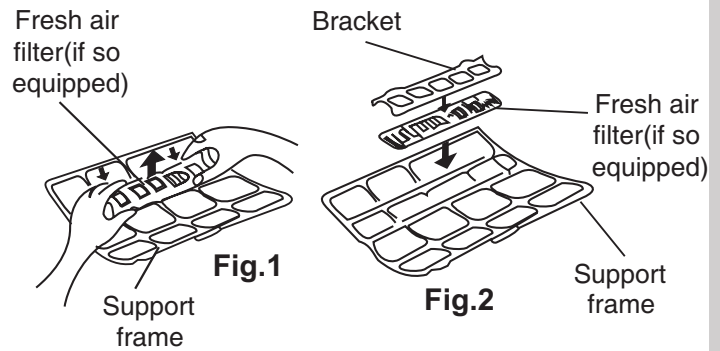

Madison
Your Appliance Authority™

800-570-3355

Maintenance

If you plan to idle the unit for a long time, perform the following:

1. Operate in fan mode for about half a day to dry the inside of the unit.
2. Stop the air conditioner and disconnect power. Remove the batteries from the remote controller.
3. The outdoor unit requires periodic maintenance and cleaning. Do not attempt to do this yourself. Contact your dealer or servicer.

Check before operation

1. Check that the wiring is not broken or disconnected.
2. Check that the air filter is installed.
3. Check whether the air outlet or inlet is blocked after the air conditioner has not been used for a long time.

Operation tips

The following events may occur during normal operation.

Protection of the air conditioner.

Compressor protection

The compressor can't restart for 3 minutes after it stops.

Anti-cold air (Only for models with heating function)

The unit is designed not to blow cold air in HEAT mode, when the indoor heat exchanger is in one of the following three situations and the set temperature has not been reached.

1. When heating has just starting.
2. Defrosting.
3. Low temperature heating.

Defrosting (Only for models with heating function)

Frost may be generated on the outdoor unit during heat cycle when outdoor temperature is low and humidity is high resulting in lower heating efficiency of the air conditioner. During this condition, air conditioner will stop heating operation and start defrosting automatically.

The time of defrosting may vary from 0 to 8 minutes according to the outdoor temperature and the amount of frost buildup on the outdoor unit.

The indoor or outdoor fan stop running when defrosting (Only for models with heating function).

A white mist coming out from the indoor unit

A white mist may generate due to a large temperature difference between air inlet and air outlet in COOL mode in an indoor environment that has a high relative humidity.

A white mist may generate due to moisture generated from defrosting process when the air conditioner restarts in HEAT mode operation after defrosting.

Low noise of the air conditioner

You may hear a low hissing sound when the compressor is running or has just stopped running. This sound is the sound of the refrigerant flowing or coming to stop.

You can also hear a low "squeak" sound when the compressor is running or has just stopped running. This is caused by heat expansion and cold contraction of the plastic parts in the unit when the temperature is changing.

A noise may be heard due to louver returning to its original position when power is first turned on.

Dust is blown out from the indoor unit.

This is a normal condition when the air conditioner has not been used for a

long time or during first use of the unit.

A peculiar smell comes out from the indoor unit.

This is because the indoor unit gives off smells permeated from building material, furniture or smoke.

The air conditioner turns to FAN only mode from COOL or HEAT (Only for models with heating function) mode.

When indoor temperature reaches the temperature setting on air conditioner, the compressor will stop automatically, and the air conditioner turns to FAN only mode. The compressor will start again when the indoor temperature rises in COOL mode or falls in HEAT mode (Only for models with heating function) to the set point.

Dripping water condenses on the surface of indoor unit

Dripping water may generate on the surface of the indoor unit when cooling in a high relative humidity (relative humidity higher than 80%). Adjust the horizontal louver to the maximum air outlet position and select HIGH fan speed.

Heating mode (Only for models with heating function)

The air conditioner draws in heat from the outdoor unit and releases it via the indoor unit during heating operation. When the outdoor temperature falls, heat drawn in by the air conditioner decreases accordingly. At the same time, heat loading of the air conditioner increases due to larger difference between indoor and outdoor temperature. If a comfortable temperature can't be achieved by the air conditioner, we suggest you use a supplementary heating device.

Auto-restart function

Power failure during operation will stop the unit completely.

For the unit without Auto-restart feature, when the power restores, the OPERATION indicator on the indoor unit starts illuminating. To restart the operation, press the ON/OFF button on the remote controller. For the unit with Auto-restart feature, when the power restores, the unit restarts automatically with all the previous settings preserved by the memory function.

Lightning or a car wireless telephone operating nearby may cause the unit to malfunction.

Disconnect the unit with power and then re-connect the unit with power again. Push the ON/OFF button on the remote controller to restart operation.

Solutions for problems

If your air conditioner malfunctions, check the following information to find solutions or probable causes of the failure. Do not try to repair the unit by yourself, if these solutions do not solve the failures, call your local service repair team.

Poor Equipment performance

1. The air outlet or inlet of outdoor unit is obstructed.
2. The air outlet or inlet of indoor unit is obstructed.
3. The outdoor temperature is high due to direct sunlight or another heat source.
4. Heater or a cooking stove is being used in the same room.
5. Room is full of people.
6. The air filter is obstructed by dust or is dirty.
7. Inappropriate temperature adjustment.
8. The capacity of the equipment is not adequate for the size of the room.
9. Air conditioner was just turn on.
10. Windows or doors are open.

The unit does not start

1. No power supply.
2. The voltage is different.
3. Temperature is not adjusted properly.
4. Fuse have blown.
5. The remote control batteries need to be replaced.
6. The time you have set with timer is incorrect.

Attention

Stop the air conditioner immediately if one of the following malfunctions occur

1. The operation indicator or other indicator flash(5 times per second) and the flashing is not stop by disconnecting the power and and then connecting it again.
2. Fuse blows frequently or circuit breaker trips frequently.
3. Water spills over the equipment.
4. Remote control does not work.
5. Any other abnormal situations.

Major Appliance 5 Year Parts Only Limited Warranty

Your appliance is covered by a five year parts only limited warranty. For five years from your original date of purchase, Electrolux will pay for the cost of replacement parts used in the repair of the appliance if the original parts prove to be defective in materials or workmanship when such appliance is installed, used and maintained in accordance with the provided instructions.

Exclusions **This limited warranty does not cover the following:**

1. Products with original serial numbers that have been removed, altered or cannot be readily determined.
2. Product that has been transferred from its original owner to another party or removed outside the USA or Canada.
3. Rust on the interior or exterior of the unit.
4. Products purchased "as-is" are not covered by this warranty.
5. Food loss due to any refrigerator or freezer failures.
6. Products used in a commercial setting.
7. Service calls to correct the installation of your appliance or to instruct you how to use your appliance.
8. Service calls which do not involve malfunction or defects in materials or workmanship, or for appliances not in ordinary household use or used other than in accordance with the provided instructions.
9. Expenses for making the appliance accessible for servicing, such as removal of trim, cupboards, shelves, etc., which are not a part of the appliance when it is shipped from the factory.
10. Service calls to repair or replace appliance light bulbs, air filters, water filters, other consumables, or knobs, handles, or other cosmetic parts.
11. Surcharges including, but not limited to, any after hour, weekend, or holiday service calls, tolls, ferry trip charges, or mileage expense for service calls to remote areas, including the state of Alaska.
12. Damages to the finish of appliance or home incurred during installation, including but not limited to floors, cabinets, walls, etc.
13. Damages caused by: services performed by unauthorized service companies; use of parts other than genuine Electrolux parts or parts obtained from persons other than authorized service companies; or external causes such as abuse, misuse, inadequate power supply, accidents, fires, or acts of God.
14. The consumer will be responsible for diagnostic, labor, and parts costs as well as any removal, transportation and reinstallation expenses which are incurred during service.
15. Labor costs for any and all repairs.

Major Appliance 5 Year Parts Only Limited Warranty

DISCLAIMER OF IMPLIED WARRANTIES; LIMITATION OF REMEDIES

CUSTOMER'S SOLE AND EXCLUSIVE REMEDY UNDER THIS LIMITED PARTS ONLY WARRANTY SHALL BE THE COST OF REPLACEMENT PARTS AS PROVIDED HEREIN. CLAIMS BASED ON IMPLIED WARRANTIES, INCLUDING WARRANTIES OF MERCHANTABILITY OR FITNESS FOR A PARTICULAR PURPOSE, ARE LIMITED TO ONE YEAR OR THE SHORTEST PERIOD ALLOWED BY LAW, BUT NOT LESS THAN ONE YEAR. ELECTROLUX SHALL NOT BE LIABLE FOR CONSEQUENTIAL OR INCIDENTAL DAMAGES SUCH AS PROPERTY DAMAGE AND INCIDENTAL EXPENSES RESULTING FROM ANY BREACH OF THIS WRITTEN LIMITED WARRANTY OR ANY IMPLIED WARRANTY. SOME STATES AND PROVINCES DO NOT ALLOW THE EXCLUSION OR LIMITATION OF INCIDENTAL OR CONSEQUENTIAL DAMAGES, OR LIMITATIONS ON THE DURATION OF IMPLIED WARRANTIES, SO THESE LIMITATIONS OR EXCLUSIONS MAY NOT APPLY TO YOU. THIS WRITTEN WARRANTY GIVES YOU SPECIFIC LEGAL RIGHTS. YOU MAY ALSO HAVE OTHER RIGHTS THAT VARY FROM STATE TO STATE.

If You Need Service

Keep your receipt, delivery slip, or some other appropriate payment record to establish the warranty period should service be required. If service is performed, it is in your best interest to obtain and keep all receipts. Service under this warranty must be obtained by contacting Electrolux at the addresses or phone numbers below.

This limited warranty only applies in the USA and Canada. In the USA, your appliance is warranted by Electrolux Major Appliances North America, a division of Electrolux Home Products, Inc. In Canada, your appliance is warranted by Electrolux Canada Corp. Electrolux authorizes no person to change or add to any obligations under this warranty. Obligations for service and parts under this warranty must be performed by Electrolux or an authorized service company. Product features or specifications as described or illustrated are subject to change without notice.

USA

1.866.942.1567

Electrolux Major Appliances
North America
P.O. Box 212378
Augusta, GA 30907

 **Electrolux**

Canada

1.866.942.1567

Electrolux Canada Corp.
5855 Terry Fox Way
Mississauga, Ontario, Canada
L5V 3E4