

# FRIGIDAIRE

All about the

# Use & Care

of your Convertible  
Freezer/Refrigerator



800-570-3355



## TABLE OF CONTENTS

Product Registration.....	2	Energy-Saving Tips.....	9
Important Safety Instructions.....	2	Care and Cleaning.....	9
First Steps.....	4	Power/Freezer Failure .....	10
Setting the Temperature Control.....	6	Before You Call.....	10
Optional Features.....	7	Major Appliance Warranty.....	13

## PRODUCT REGISTRATION

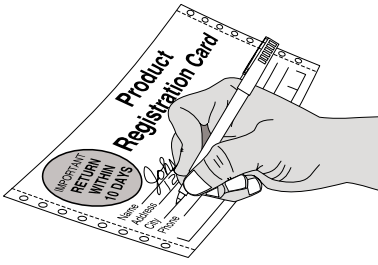

### Read and Save These Instructions

This Owner's Guide provides specific operating instructions for your model. Use your appliance only as instructed in this guide. These instructions are not meant to cover every possible condition and situation that may occur. Common sense and caution must be practiced when installing, operating, and maintaining any appliance.

### Record Your Model and Serial Numbers

Record the model and serial numbers in the space provided below.

**Model Number:** \_\_\_\_\_

**Serial Number:** \_\_\_\_\_

**Purchase Date:** \_\_\_\_\_

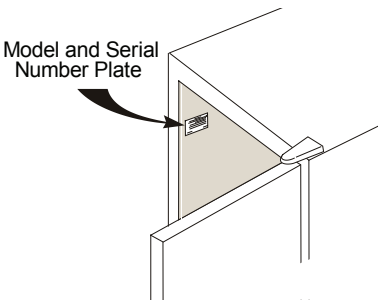

### Register Your Product

The self-addressed **PRODUCT REGISTRATION CARD** (shown above) should be filled in completely, signed and returned to Electrolux Home Products.

This Use and Care Guide provides operating instructions for your model. Use your unit only as instructed in this Use and Care Guide.

## IMPORTANT SAFETY INSTRUCTIONS

### **WARNING**

Please read all instructions before using this unit.

### Definitions

 This is the safety alert symbol. It is used to alert you to potential personal injury hazards. Obey all safety messages that follow this symbol to avoid possible injury or death.

### **DANGER**

DANGER indicates an imminently hazardous situation which, if not avoided, will result in death or serious injury.

### **WARNING**

WARNING indicates a potentially hazardous situation which, if not avoided, could result in death or serious injury.

### **CAUTION**

CAUTION indicates a potentially hazardous situation which, if not avoided, may result in minor or moderate injury.

### **IMPORTANT**

IMPORTANT indicates installation, operation or maintenance information which is important but not hazard-related.

### **WARNING**

#### For your safety

- Do not store or use gasoline or other flammable vapors and liquids in the vicinity of this unit or any other appliance. Read product labels for flammability and other warnings.
- Do not operate the unit in the presence of explosive fumes.
- Remove and discard any spacers used to secure the shelves during shipping. Small objects are a choke hazard to children.
- Remove all staples from the carton. Staples can cause severe cuts, and also destroy finishes if they come in contact with other appliances or furniture.

# IMPORTANT SAFETY INSTRUCTIONS

## WARNING

### Child Safety

- Destroy carton, plastic bags, and any exterior wrapping material immediately after the unit is unpacked. Children should never use these items for play. Cartons covered with rugs, bedspreads, plastic sheets or stretch wrap may become airtight chambers and can quickly cause suffocation.
- An empty, discarded icebox, refrigerator, or freezer is a very dangerous attraction to children.
- Remove the door(s) of any appliance that is not in use, even if it is being discarded.

## WARNING

### Risk of child entrapment

Child entrapment and suffocation are not problems of the past. Junked or abandoned appliances are still dangerous – even if they will sit for “just a few days”. If you are getting rid of your old appliance, please follow the instructions below to help prevent accidents.

We strongly encourage responsible appliance recycling/disposal methods. Check with your utility company or visit [www.recyclemyoldfridge.com](http://www.recyclemyoldfridge.com) for more information on recycling your old appliance.

### Before you throw away your old appliance:

- Remove door.
- Leave shelves in place so children may not easily climb inside.
- Have the refrigerant removed by a qualified technician.

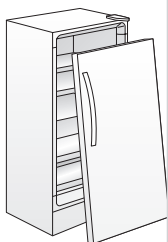

## WARNING

Avoid fire hazard or electric shock. Do not use an extension cord or an adapter plug. Do not remove any prong from power cord.

Grounding type wall receptacle

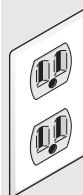

**Do not, under any circumstances, cut, remove, or bypass the grounding prong.**

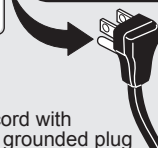

Power cord with 3-prong grounded plug

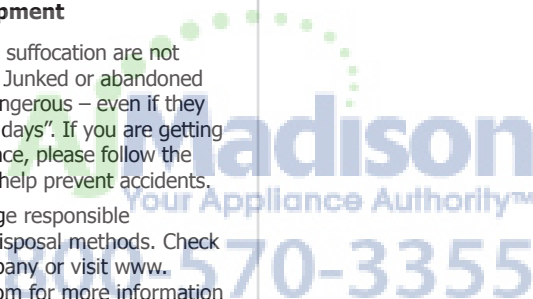
 Madison  
Your Appliance Authority™  
570-3355

## IMPORTANT SAFETY INSTRUCTIONS

## FIRST STEPS

### WARNING

#### Electrical Information

These guidelines must be followed to ensure that safety mechanisms in the design of this appliance will operate properly.

- Refer to the serial plate for correct electrical rating. The power cord of the appliance is equipped with a three-prong grounding plug for your protection against electrical shock hazards. It must be plugged directly into a properly grounded three-prong receptacle, protected with a 15-amp time delay fuse or circuit breaker. The receptacle must be installed in accordance with the local codes and ordinances. Consult a qualified electrician. Receptacles protected by Ground Fault Circuit Interrupters (GFCI) are NOT RECOMMENDED. Do NOT use an extension cord or adapter plug.
- If voltage varies by 10 percent or more, appliance performance may be affected. Operating the unit with insufficient power can damage the compressor. Such damage is not covered under the warranty. If you suspect your household voltage is high or low, consult your power company for testing.
- To prevent the appliance from being turned off accidentally, do not plug unit into an outlet controlled by a wall switch or pull cord.
- Do not pinch, knot, or bend power cord in any manner.

### WARNING

#### Other Precautions

- To defrost, always unplug unit first.
- Never unplug the unit by pulling on the power cord. Always grip the plug firmly and pull straight out from the receptacle.
- Turning the control to "OFF" turns off the compressor but does not disconnect power to other electrical components.

This Use & Care Guide provides general operating instructions for your model. Use the unit only as instructed in this Use & Care Guide. **Before starting the unit, follow these important first steps.**

#### Location

Choose a place that is near a grounded electrical outlet.

For the most efficient operation, the appliance should be located where surrounding temperatures will not exceed 110°F (43°C). Temperatures of 32°F (0°C) and below will NOT affect freezer operation. Additional compressor heaters are not recommended. Allow space around the unit for good air circulation. Leave a 3 inch (75 mm) space on all sides of the unit for adequate circulation.

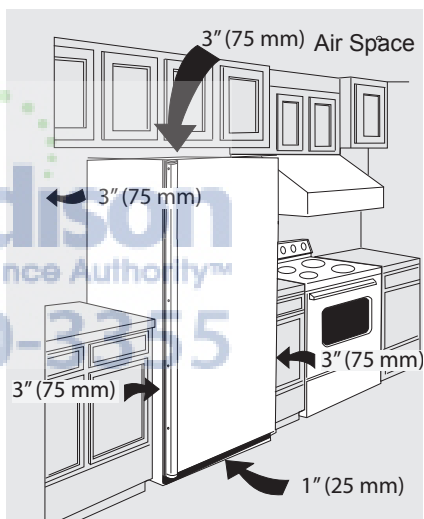

#### Leveling

The appliance must have all bottom corners resting firmly on a solid floor. The floor must be strong enough to support a fully loaded unit.

### NOTE

It is very important for your appliance to be level in order to function properly. If the unit is not leveled during installation, the door may be misaligned and not close or seal properly, causing cooling, frost, or moisture problems.

## To Level Upright Units:

After discarding crating screws, use a carpenter's level to level the appliance from front-to-back. Adjust the plastic leveling feet in front, ½ bubble higher, so that the door closes easily when left halfway open.



## CAUTION

To allow door to close and seal properly, DO NOT let food packages extend past the front of shelves.

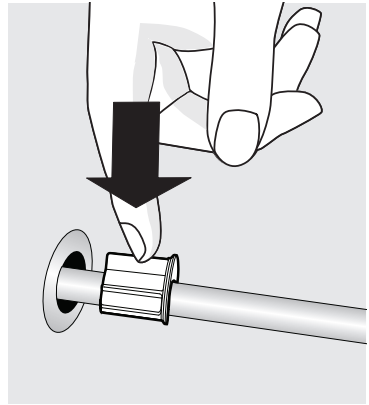
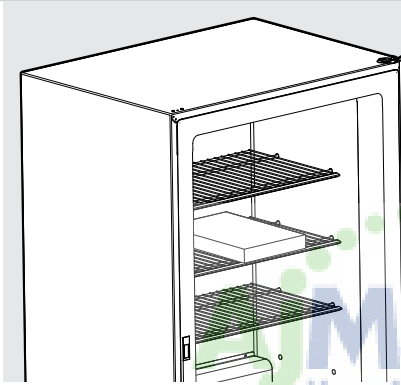

- Slide the shelf grommet into the grommet already in the freezer wall until it is flush.

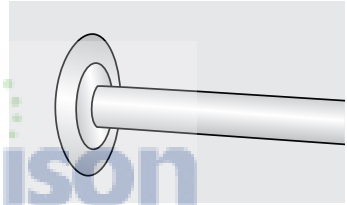

## To install the shelf grommet to the shelf:

- With the wire shelf installed, press the shelf grommet down onto the wire that is anchored into the freezer wall. Be sure to keep the larger end of the shelf grommet away from the wall.

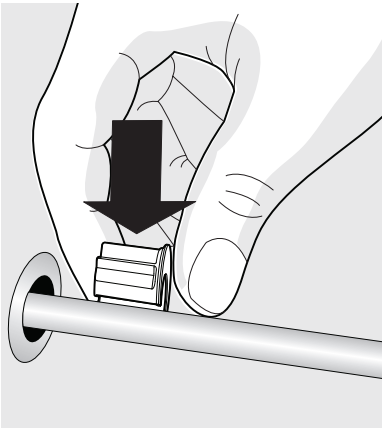

- Push the shelf grommet onto the wire until it snaps in place.

## To install the handle clips to the basket:

- Place the basket on a firm, flat surface.
- With the narrow side of the handle clip on the inside of the basket, snap the handle clip to the recessed area in the basket.

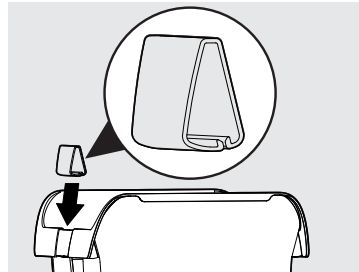

## FIRST STEPS

3. Once the inside surface snaps in place, continue the process by rolling the handle clip slightly outward and pressing down firmly to snap onto the outside surface. If installed incorrectly, the handle clip will not lay flat.

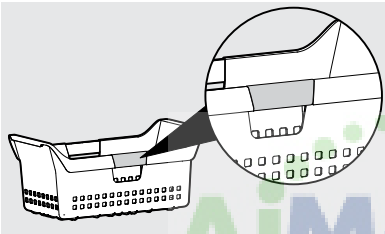
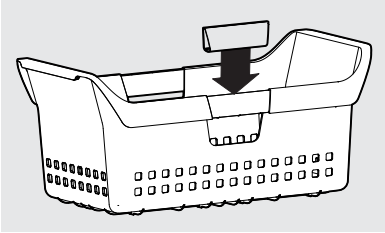

## SETTING THE TEMPERATURE CONTROL

### Cool Down Period

For safe food storage, allow 4 hours for the unit to cool down completely. The appliance will run continuously for the first several hours. Foods that are already frozen may be placed in the freezer after the first few hours of operation. Unfrozen foods should **NOT** be loaded into the freezer until freezer has operated for four (4) hours.

When loading freezer, freeze only three (3) pounds of fresh food per cubic foot of freezer space at one time. Distribute packages to be frozen evenly throughout the freezer. It is not necessary to turn the control knob to a colder setting while freezing food.

### Door Removal

If door must be removed, unplug the unit.

1. Gently lay appliance on its back, on a rug or blanket.
2. Remove two base screws and base panel.
3. Remove wire from clips on bottom of cabinet if required.
4. Unplug connector, if required, by holding the cabinet connector in place, and pulling door connector out.
5. Remove bottom hinge screws.
6. Remove plastic top hinge cover.
7. Remove screws from top hinge.
8. Remove top hinge from cabinet.
9. Remove door and bottom hinge from cabinet.
10. To replace door, reverse the above order and securely tighten all screws to prevent hinge slippage.

## OPTIONAL FEATURES

### NOTE

Your appliance may have some, or all of the features listed below. Become familiar with these features, and their use and care.

### Temperature Control

#### Electromechanical Temperature Control (some models)

The convertible model can operate as either a freezer or a refrigerator. The electromechanical temperature control provides this adjustment and is located inside the appliance. The temperature is factory preset to provide satisfactory food storage temperatures. However, the temperature control is adjustable to provide a range of temperatures for your personal satisfaction.

To adjust the temperature setting, turn the temperature control knob clockwise or counterclockwise. When the dial indicator is in the "fridge" section, the unit is in refrigerator mode. Turning past that section into the "freezer" portion, selects the freezer mode. Allow several hours for the temperature to stabilize between adjustments.



## Electronic Temperature Control (some models)

The convertible model can operate as either a freezer or a refrigerator. The selection is made by pressing and holding the “-” and “SET” keys on the control panel. The display will indicate whether it is in the refrigerator or freezer mode.

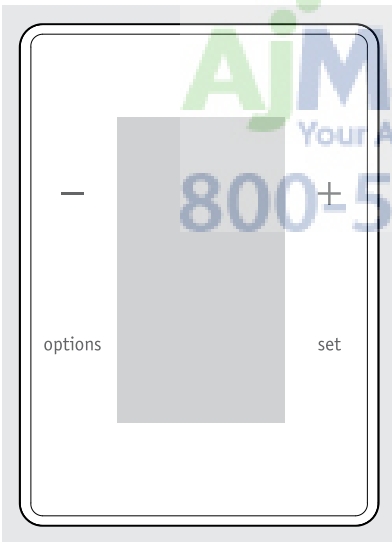

The temperature is factory preset to provide satisfactory food storage temperatures. To adjust the temperature setting, press the “+” button for warmer temperatures and the “-” button for colder temperatures. Allow several hours for the temperature to stabilize between adjustments.

## Automatic Freeze Control

When in the refrigerator mode the Freeze Control Feature will maintain proper interior refrigerator temperature even when the refrigerator is placed in an area where the surrounding temperature drops to 10°F (-12°C).

## Electronic Temp Alarm

If a malfunction causes an unsafe temperature inside the freezer, the high temp will display on the control panel and the alarm will sound. To silence the alarm, press the set button next to the “alarm off” indicator on the display or any key on the control panel.

## Quick Freeze

Quick freeze can be enabled by entering into the options menu on the control panel and by pressing the “set” button once the indicator is highlighted next to “quick freeze”. The unit will be in quick freeze mode for 72 hours and will show a snowflake indicator on the control panel to indicate that it is in quick freeze mode. To exit quick freeze mode, enter into the options menu on the control panel and press the “set” button once the indicator is highlighted next to “quick freeze,” after which the snowflake indicator will be removed from the control panel. Or quick freeze will end automatically after 72 hours.

## Control lock

Control lock can be enabled by entering into the options menu on the control panel and by pressing the “set” button once the indicator is highlighted next to “control lock”. A control lock icon will be displayed on the control panel to indicate that the control panel has been locked. To unlock, press and hold the set button for 3 seconds, after which the lock indicator will be removed from the control panel and the control panel has been unlocked.

## Power Off

To shut cooling off to the unit and to turn off the interior lights of the unit, enter into the options menu on the control panel and press and hold the “set” button for 3 seconds once the indicator is highlighted next to “power off”. “Power off” will be displayed on the control panel to indicate that the unit is in the powered off mode. To turn power back on to the unit, press and hold the “set” key for 3 seconds. After which the power off indicator will be removed from the control panel and the set point of the unit will be displayed again.

## OPTIONAL FEATURES

### Power Fail

If your unit has lost power, the control panel will display "power fail" and the number of hours that your unit has been without power up to a maximum of 50 hrs. The alarm will sound until the condition is acknowledged by pressing the set button or any other button on the control panel.

### Door Ajar

If your door has been left open for more than 5 minutes, the control panel will display "door ajar" and will sound an alarm until the door has been closed or any button is pressed on the control panel. If a button on the control panel has been pressed but the door has not been closed, "door ajar" will continue to be displayed on the control panel until the door has been closed.

### Sabbath Mode

The Sabbath mode is a feature that disables portions of the appliance and its controls in accordance with observance of the weekly Sabbath and religious holidays within the Orthodox Jewish community.

To turn Sabbath mode on, press and hold the "Options" button and "+" button for 5 seconds, after which "Sb" will be displayed on the control panel indicating that the unit is in Sabbath mode. To exit Sabbath mode, press and hold the "Options" button and "+" button for 5 seconds, after which the display will return to displaying the set point of the unit.

In the Sabbath mode, the High Temp alarm is active for health reasons. If a high temperature alarm is activated during this time, for example due to a door left ajar, the alarm will sound for about 10 minutes. The alarm will then silence on its own and a "high temp" icon will be displayed on the control panel. The high temp icon will continue to display even if the door is closed until Sabbath mode is exited and the icon reset.

 For further assistance, guidelines of proper usage and a complete list of models with the Sabbath feature, please visit the web at <http://www.star-k.org>.

### NOTE

While in Sabbath mode, neither the lights nor the control panel will work until Sabbath mode has been deactivated.

The unit stays in Sabbath mode after a power failure recovery. It must be deactivated with the buttons on the control panel.

### Adjustable Interior Shelves

Multi-position adjustable interior shelves can be moved to any position for larger or smaller packages. The shipping spacers that stabilize the shelves for shipping should be removed and discarded.

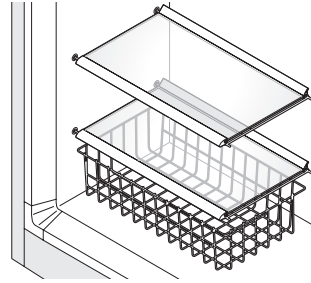

### Door storage

Door bins, shelves, and racks are provided for convenient storage of jars, bottles, and cans. Frequently used items can be quickly selected.

Some models have door racks or bins that can accommodate gallon-sized plastic drink containers and economy-sized jars and containers.

The dairy compartment, which is warmer than the general food storage section, is intended for short term storage of cheese, spreads, or butter.

### Adjustable door bins

Some models have adjustable door bins that can be moved to suit individual needs.

To move door bins:

1. Lift bin straight up.
2. Remove bin.
3. Place bin in desired position.
4. Lower bin onto supports until locked in place.

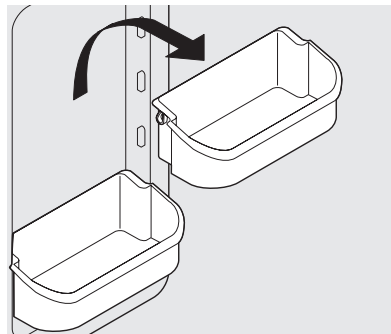



## Crispers (some models)

The crispers, located under the bottom refrigerator shelf, are designed for storing fruits, vegetables, and other fresh produce. Wash items in clear water and remove excess water before placing them in the crispers. Items with strong odors or high moisture content should be wrapped before storing.

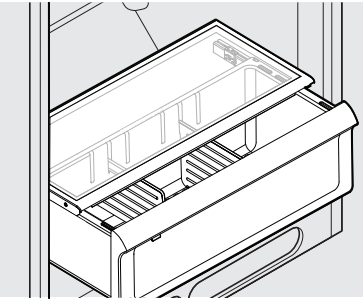

## CAUTION

- Damp objects stick to cold metal surfaces. Do not touch interior metal surfaces with wet or damp hands.
- Appliance must be unplugged (to avoid electrical hazard) from power source when defrosting unit.

Convertible model is frost free and will defrost automatically, but should be cleaned occasionally.

## Cleaning the Inside

Wash inside surfaces of the unit with a solution of 2 tbsp. (25 g) of baking soda in 1 qt. (1 l) warm water. Rinse and dry. Wring excess water out of the sponge or cloth.

Wash the removable parts with the baking soda solution mentioned above or mild detergent and warm water. Rinse and dry. **Never** use metallic scouring pads, brushes, abrasive cleaners, or alkaline solutions on any surface. Do not wash removable parts in a dishwasher.

## Cleaning the Outside

Wash the cabinet with warm water and mild liquid detergent. Rinse well and wipe dry with a clean soft cloth. Replace parts and food.

Do not use razor blades or other sharp instruments, which can scratch the surface when removing adhesive labels. Any glue left from the tape can be removed with a mixture of warm water and mild detergent, or touch the residue with the sticky side of the tape already removed.

**DO NOT REMOVE THE SERIAL PLATE.**



## WARNING

If leaving door open while on vacation, make certain that children cannot get into the appliance and become entrapped.

## ENERGY-SAVING TIPS



- The appliance should be located in the coolest area of the room, away from heat-producing appliances or heating ducts, and out of direct sunlight.
- Let hot foods cool to room temperature before

placing in the unit. Overloading the unit forces the compressor to run longer. Foods that freeze too slowly may lose quality or spoil.

- Be sure to wrap foods properly and wipe containers dry before placing them in the appliance. This cuts down on frost build-up inside the unit.
- Appliance shelves and baskets should not be lined with aluminum foil, wax paper, or paper toweling. Liners interfere with cold air circulation, making the unit less efficient.
- Organize and label food to reduce door openings and extended searches. Remove as many items as needed at one time, and close door as soon as possible.

## NOTE

**DO NOT** open appliance door unnecessarily if unit is off for several hours.

## Vacation and Moving Tips

**Short Vacations:** Leave the unit operating during vacations of less than three weeks.

**Long Vacations:** If the appliance will not be used for several months, remove all food and unplug the power cord. Clean and dry the interior thoroughly. To prevent odor and mold growth, leave the appliance door open slightly, blocking it open if necessary.

**Moving:** Disconnect the power cord plug from the wall outlet. Remove food, defrost, and then clean the unit. Secure all loose items such as base panel, baskets, and shelves by taping them securely in place to prevent damage. In the moving vehicle, secure the appliance in an upright position, and secure to prevent movement. Also protect outside of the unit with a blanket, or similar item.

**If a power failure occurs,** frozen foods will stay frozen for at least 24 hours if the appliance is kept closed. If the power failure continues, pack seven or eight pounds of dry ice into the unit every 24 hours. Look in the Yellow Pages under "Dry Ice", "Dairies", or "Ice Cream Manufacturers" for local dry ice suppliers. Always wear gloves and use caution when handling dry ice.

**If the appliance has stopped operating,** see the "Freezer does not run" section in the Avoid Service Checklist section of this use and care guide. If you cannot solve the problem, call an authorized service personnel immediately.

**If the unit remains off for several hours,** follow the directions above for the use of dry ice during a power failure. If necessary, take the food to a local locker plant until the appliance is ready to operate. Look in the Yellow Pages under "Frozen Food Locker Plants".

## BEFORE YOU CALL

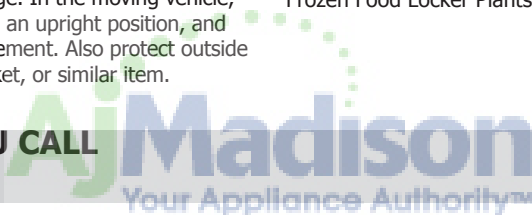

**1-800-944-9044** (United States)  
**1-800-265-8352** (Canada)

Visit our web site at  
[www.frigidaire.com](http://www.frigidaire.com)

Before calling for service, review this list. It may save you time and expense. This list includes common occurrences that are not the result of defective workmanship or materials in this appliance.

PROBLEM	CAUSE	CORRECTION
<b>APPLIANCE OPERATION</b>		
<b>Appliance does not run.</b>	<ul style="list-style-type: none"> <li>Appliance is plugged into a circuit that has a ground fault interrupt.</li> <li>Temperature Control is in the OFF position.</li> <li>Appliance may not be plugged in or plug is loose.</li> <li>House fuse blown or tripped circuit breaker.</li> <li>Power outage</li> </ul>	<ul style="list-style-type: none"> <li>Use another circuit. If you are unsure about the outlet, have it checked by a certified technician.</li> <li>See <b>Setting the Temperature Control</b> section.</li> <li>Ensure plug is tightly pushed into outlet.</li> <li>Check/replace fuse with a 15-amp time-delay fuse. Reset circuit breaker.</li> <li>Check house lights. Call local electric company.</li> </ul>

## BEFORE YOU CALL

PROBLEM	CAUSE	CORRECTION
<b>Appliance runs too much or too long.</b>	<ul style="list-style-type: none"> <li>• Room or outside weather is hot.</li> <li>• Appliance has recently been disconnected for a period of time.</li> <li>• Large amounts of warm or hot food have been stored recently.</li> <li>• Door is opened too frequently or too long.</li> <li>• Appliance door may be slightly open.</li> <li>• Temperature control is set too low.</li> <li>• Appliance gaskets are dirty, worn, cracked, or poorly fitted.</li> </ul>	<ul style="list-style-type: none"> <li>• It's normal for the appliance to work longer under these conditions.</li> <li>• It takes 24 hours for the appliance to cool down completely.</li> <li>• Warm food will cause appliance to run more until the desired temperature is reached.</li> <li>• Warm air entering the appliance causes it to run more. Open door less often.</li> <li>• See "DOOR PROBLEMS".</li> <li>• Turn control knob to a warmer setting. Allow several hours for the temperature to stabilize.</li> <li>• Clean or change gasket. Leaks in door seal will cause appliance to run longer in order to maintain desired temperatures.</li> </ul>
<b>Pressing the "-" or "+" buttons on the control panel does not change the set points</b>	<ul style="list-style-type: none"> <li>• Verify the control panel is not locked or in Sabbath mode</li> </ul>	<ul style="list-style-type: none"> <li>• To unlock, press and hold the "set" button for 3 seconds; to exit Sabbath mode, press and hold "set" and "Options" for 5 seconds.</li> </ul>
<b>APPLIANCE TEMPERATURES</b>		
<b>Interior appliance temperature is too cold.</b>	<ul style="list-style-type: none"> <li>• Temperature control is set too low.</li> <li>• The unit is in quick freeze mode.</li> </ul>	<ul style="list-style-type: none"> <li>• Set control to a warmer setting. Allow several hours for temperature to stabilize.</li> <li>• Exit quick freeze mode by entering into the options menu on the control panel and pressing the "set" button once the indicator is highlighted next to "quick freeze".</li> </ul>
<b>Temperature inside appliance is too warm.</b>	<ul style="list-style-type: none"> <li>• The unit is in Freezer mode.</li> <li>• Door is opened too frequently or too long.</li> <li>• Door may not be seating properly.</li> <li>• Large amounts of warm or hot food has been stored recently.</li> <li>• Appliance has recently been disconnected for a period of time.</li> </ul>	<ul style="list-style-type: none"> <li>• Set control to a warmer setting. Allow several hours for temperature to stabilize.</li> <li>• Warm air enters the appliance every time the door is opened. Open door less often.</li> <li>• See "DOOR PROBLEMS".</li> <li>• Wait until the appliance has had a chance to reach its selected temperature.</li> <li>• Appliance requires 24 hours to cool down completely.</li> </ul>
<b>Temperature of external appliance is too warm.</b>	<ul style="list-style-type: none"> <li>• The external walls can be as much as 30° F warmer than room temperature.</li> </ul>	<ul style="list-style-type: none"> <li>• Turn control to a colder setting. Allow several hours for for the temperature to stabilize.</li> </ul>
<b>SOUND AND NOISE</b>		
<b>Louder sound levels when appliance is on.</b>	<ul style="list-style-type: none"> <li>• Modern appliance have increased storage capacity and more stable temperatures. They require a high efficiency compressor.</li> </ul>	<ul style="list-style-type: none"> <li>• This is normal. When the surrounding noise is low, you might hear the compressor running while it cools the interior.</li> </ul>

## BEFORE YOU CALL

PROBLEM	CAUSE	CORRECTION
<b>Longer sound levels when compressor comes on.</b>	<ul style="list-style-type: none"> <li>Appliance operates at higher pressures during the start of the ON cycle.</li> </ul>	<ul style="list-style-type: none"> <li>This is normal. Sound will level off or disappear as appliance continues to run.</li> </ul>
<b>Popping or cracking sound when compressor comes on.</b>	<ul style="list-style-type: none"> <li>Metal parts undergo expansion and contraction, as in hot water pipes.</li> </ul>	<ul style="list-style-type: none"> <li>This is normal. Sound will level off or disappear as appliance continues to run.</li> </ul>
<b>Bubbling or gurgling sound, like water boiling.</b>	<ul style="list-style-type: none"> <li>Refrigerant (used to cool the appliance) is circulating throughout the system.</li> </ul>	<ul style="list-style-type: none"> <li>This is normal.</li> </ul>
<b>Vibrating or rattling noise.</b>	<ul style="list-style-type: none"> <li>Appliance is not level. It rocks on the floor when it is moved slightly.</li> <li>Floor is uneven or weak.</li> <li>Appliance is touching the wall.</li> </ul>	<ul style="list-style-type: none"> <li>Level the unit. Refer to "Leveling" in the <b>First Steps</b> Section.</li> <li>Ensure floor can adequately support appliance. Level the appliance by putting wood or metal shims under part of the freezer.</li> <li>Re-level the appliance or move appliance slightly. Refer to "Leveling" in the <b>First Steps</b> Section.</li> </ul>
<b>Alarm is sounding from the control panel</b>	<ul style="list-style-type: none"> <li>Look on the control panel to determine which indicator light is on (High Temp, Power Fail, or Door Ajar).</li> </ul>	<ul style="list-style-type: none"> <li>Press the "set" button to acknowledge the alarm or close the door if the door ajar indicator is shown.</li> </ul>
<b>WATER/MOISTURE/FROST INSIDE APPLIANCE</b>		
<b>Moisture forms on inside appliance walls.</b>	<ul style="list-style-type: none"> <li>Weather is hot and humid.</li> <li>Door is opened too often or too long.</li> </ul>	<ul style="list-style-type: none"> <li>This is normal.</li> <li>Open door less often.</li> </ul>
<b>ODOR IN APPLIANCE</b>		
<b>Odor in appliance.</b>	<ul style="list-style-type: none"> <li>Interior needs to be cleaned.</li> <li>Foods with strong odors are in the appliance.</li> </ul>	<ul style="list-style-type: none"> <li>Clean interior with sponge, warm water, and baking soda.</li> <li>Cover the food tightly.</li> </ul>
<b>LIGHTING PROBLEMS</b>		
<b>Light bulb is not on.</b>	<ul style="list-style-type: none"> <li>No electric current is reaching the appliance</li> <li>Control is in Sabbath mode (Sb is displayed on control)</li> </ul>	<ul style="list-style-type: none"> <li>See "APPLIANCE DOES NOT RUN".</li> <li>Depress TEMP MODE key and CONTROL LOCK key for 3 seconds.</li> </ul>

# MAJOR APPLIANCE WARRANTY

Your appliance is covered by a one year limited warranty. For one year from your original date of purchase, Electrolux will pay all costs for repairing or replacing any parts of this appliance that prove to be defective in materials or workmanship when such appliance is installed, used and maintained in accordance with the provided instructions.

**Exclusions**    **This warranty does not cover the following:**

1. Products with original serial numbers that have been removed, altered or cannot be readily determined.
2. Product that has been transferred from its original owner to another party or removed outside the USA or Canada.
3. Rust on the interior or exterior of the unit.
4. Products purchased "as-is" are not covered by this warranty.
5. Food loss due to any refrigerator or freezer failures.
6. Products used in a commercial setting.
7. Service calls which do not involve malfunction or defects in materials or workmanship, or for appliances not in ordinary household use or used other than in accordance with the provided instructions.
8. Service calls to correct the installation of your appliance or to instruct you how to use your appliance.
9. Expenses for making the appliance accessible for servicing, such as removal of trim, cupboards, shelves, etc., which are not a part of the appliance when it is shipped from the factory.
10. Service calls to repair or replace appliance light bulbs, air filters, water filters, other consumables, or knobs, handles, or other cosmetic parts.
11. Surcharges including, but not limited to, any after hour, weekend, or holiday service calls, tolls, ferry trip charges, or mileage expense for service calls to remote areas, including the state of Alaska.
12. Damages to the finish of appliance or home incurred during installation, including but not limited to floors, cabinets, walls, etc.
13. Damages caused by: services performed by unauthorized service companies; use of parts other than genuine Electrolux parts or parts obtained from persons other than authorized service companies; or external causes such as abuse, misuse, inadequate power supply, accidents, fires, or acts of God.

**DISCLAIMER OF IMPLIED WARRANTIES; LIMITATION OF REMEDIES**

CUSTOMER'S SOLE AND EXCLUSIVE REMEDY UNDER THIS LIMITED WARRANTY SHALL BE PRODUCT REPAIR OR REPLACEMENT AS PROVIDED HEREIN. CLAIMS BASED ON IMPLIED WARRANTIES, INCLUDING WARRANTIES OF MERCHANTABILITY OR FITNESS FOR A PARTICULAR PURPOSE, ARE LIMITED TO ONE YEAR OR THE SHORTEST PERIOD ALLOWED BY LAW, BUT NOT LESS THAN ONE YEAR. ELECTROLUX SHALL NOT BE LIABLE FOR CONSEQUENTIAL OR INCIDENTAL DAMAGES SUCH AS PROPERTY DAMAGE AND INCIDENTAL EXPENSES RESULTING FROM ANY BREACH OF THIS WRITTEN LIMITED WARRANTY OR ANY IMPLIED WARRANTY. SOME STATES AND PROVINCES DO NOT ALLOW THE EXCLUSION OR LIMITATION OF INCIDENTAL OR CONSEQUENTIAL DAMAGES, OR LIMITATIONS ON THE DURATION OF IMPLIED WARRANTIES, SO THESE LIMITATIONS OR EXCLUSIONS MAY NOT APPLY TO YOU. THIS WRITTEN WARRANTY GIVES YOU SPECIFIC LEGAL RIGHTS. YOU MAY ALSO HAVE OTHER RIGHTS THAT VARY FROM STATE TO STATE.

**If You Need Service**    Keep your receipt, delivery slip, or some other appropriate payment record to establish the warranty period should service be required. If service is performed, it is in your best interest to obtain and keep all receipts. Service under this warranty must be obtained by contacting Electrolux at the addresses or phone numbers below.

This warranty only applies in the USA and Canada. In the USA, your appliance is warranted by Electrolux Major Appliances North America, a division of Electrolux Home Products, Inc. In Canada, your appliance is warranted by Electrolux Canada Corp. Electrolux authorizes no person to change or add to any obligations under this warranty. Obligations for service and parts under this warranty must be performed by Electrolux or an authorized service company. Product features or specifications as described or illustrated are subject to change without notice.

**USA**  
**1.800.944.9044**  
Frigidaire  
10200 David Taylor Drive  
Charlotte, NC 28262



**Electrolux**

**Canada**  
**1.800.265.8352**  
Electrolux Canada Corp.  
5855 Terry Fox Way  
Mississauga, Ontario, Canada  
L5V 3E4