

FRIGIDAIRE

All about the

Use & Care

of your Wall Oven

AjMadison
Your Appliance Authority™

800-570-3355

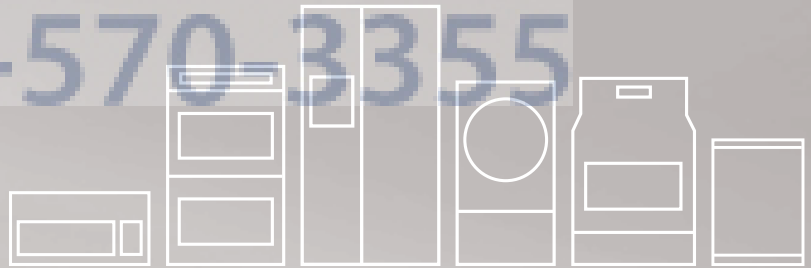

TABLE OF CONTENTS

Product Record and Registration	2	care and cleaning	26
Important Safety Instructions	3	Warranty	32
Before Setting Oven Controls	7		
Oven Controls	8		

PRODUCT RECORD AND REGISTRATION

Need Help?	2
Product Registration	2
Product Record and Registration	2
Important Safety Instructions	3
Before Setting Oven Controls	7
Oven Controls	8
care and cleaning	26
Warranty	32

Thank you for choosing Frigidaire.

Important: This Use and Care Guide is part of our commitment to customer satisfaction and product quality throughout the service life of your new appliance. We view your purchase as the beginning of a relationship. To ensure our ability to continue serving you, please use this page to record important product information.

Need Help?

Visit the Frigidaire web site at www.frigidaire.com

Before you call for service, there are a few things you can do to help us serve you better.

Read this Use & Care Manual

This manual contains instructions to help you use and maintain your range properly.

If You Received a Damaged Range...

Immediately contact the dealer (or builder) that sold you the range.

Save Time and Money

Check the section title "Before You Call". This section helps step you through some common problems that might occur.

If you do need service, help is only a phone call away. Call Frigidaire Customer Services at **1-800-944-9044**.

Product Registration

Registering your product with Frigidaire enhances our ability to serve you. Register online at www.frigidaire.com or by dropping your Product Registration Card in the mail.

Record model & serial numbers here

Purchase Date

Frigidaire model number

Frigidaire serial number

Serial Plate Location

Open lower oven door (some models) or storage drawer (some models). Serial plate is on the door frame.

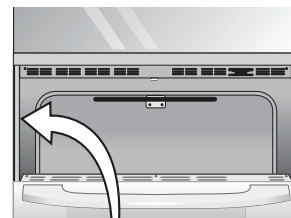

Questions?

For toll-free telephone support in the U.S. and Canada call **1-800-944-9044** (is Canada just for Electrolux?)

For online support and Internet production information visit <http://www.frigidaire.com>.

IMPORTANT SAFETY INSTRUCTIONS

CAUTIONS AND WARNINGS

Read all instructions before using this appliance.

This manual contains important safety symbols and instructions. Please pay attention to these symbols and follow all instructions given.

Do not attempt to install or operate your appliance until you have read the safety precautions in this manual. Safety items throughout this manual are labeled with a WARNING or CAUTION statement based on the risk type.

DEFINITIONS

 This is the safety alert symbol. It is used to alert you to potential personal injury hazards. Obey all safety messages that follow this symbol to avoid possible injury or death.

WARNING

Indicates a potentially hazardous situation which, if not avoided, may result in death or serious injury.

CAUTION

Indicates a potentially hazardous situation which, if not avoided, may result in minor or moderate injury.

IMPORTANT

Indicates installation, operation, maintenance, or valuable information that is not hazard related.

NOTE

Indicates a short, informal reference—something written down to assist the memory or for future reference.

WARNING



Tip Over Hazard

- A child or adult can tip the oven and be killed.
- Install the anti-tip device to oven and/or structure per installation instructions.
- Ensure the anti-tip device is re-engaged when the oven is moved.
- Do not operate the oven without the anti-tip device in place and engaged.
- Failure to follow these instructions can result in death or serious burns to children and adults.

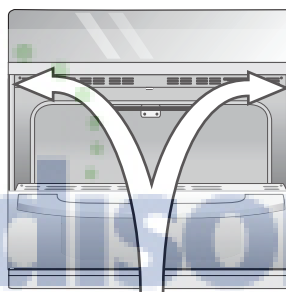

Anti-tip mounting holes

Refer to the installation instructions supplied with your appliance for proper installation.

Check for proper installation with a visual check that the anti-tip screws are present. Test the installation with light downward pressure on the open oven door. The oven should not tip forward.

WARNING

Storage In or On Appliance—Flammable materials should not be stored in an oven, in the storage drawer, warmer drawer, or lower oven. This includes paper, plastic, and cloth items, such as cookbooks, plastic ware, and towels, as well as flammable liquids. Do not store explosives, such as aerosol cans, on or near the wall oven.

IMPORTANT SAFETY INSTRUCTIONS

WARNING

- Do Not Leave Children Alone - Children should not be left alone or unattended in the area where appliance is in use. They should never be allowed to sit or stand on any part of the appliance, including the storage drawer, lower broiler drawer, warmer drawer, or lower double oven.
- Stepping, leaning, or sitting on the door or drawers of an oven can result in serious injuries and also cause damage to the appliance. Do not allow children to climb or play around the oven. The weights of a child on an open oven door may cause the oven to tip, resulting in serious burns or other injury.
- Never cover any slots, holes, or passages in the oven bottom or cover an entire oven rack with materials, such as aluminum foil. Aluminum foil linings may trap heat, causing a fire hazard.
- Do not touch heating elements or interior surfaces of oven. Heating elements may be hot even though they are dark in color. Interior surfaces of ovens become hot enough to cause burns. During and after use, do not touch, or let clothing or other flammable materials contact heating elements or interior surfaces of oven until they have sufficient time to cool. Other surfaces of the appliance may become hot enough to cause burns such as the oven door, windows, and the oven vent.

CAUTION

- When heating fat or grease, watch it closely. Grease may catch fire if it becomes too hot.
- Do not use water or flour on grease fires. Cover the fire with a pan lid, use baking soda, or use a dry chemical or foam type extinguisher.
- Use dry potholders. Moist or damp potholders on hot surfaces may result in burns from steam. Do not let potholders touch hot cooking areas. Do not use towels or other bulky cloths.
- Wear proper apparel. Loose fitting or hanging garments should never be worn while using the appliance.
- Do not heat unopened food containers. Build-up of pressure may cause container to burst and result in injury.

IMPORTANT

Important Safety Notice - The California Safe Drinking Water and Toxic Enforcement Act requires the governor of California to publish a list of substances known to cause cancer, birth defects, or other reproductive harms, and requires businesses to warn customers of potential exposures to such substances.

IMPORTANT

Read and follow all important instructions and precautions for unpacking, installing, and servicing your appliance.

Remove all tape and packaging before using the oven. Destroy the carton and plastic bags after unpacking the oven. Never allow children to play with packaging material.

IMPORTANT SAFETY INSTRUCTIONS

IMPORTANT INSTRUCTIONS FOR USING OVEN

- Never use your appliance for warming or heating the room.
- Use care when opening oven door, lower oven door, or warmer drawer (some models). Stand to the side of the oven when opening the door of a hot oven. Let hot air or steam escape before you remove or replace food in the oven.
- Keep oven vent ducts clear. Touching surfaces in this area when the oven is on may cause severe burns. Do not place plastic or heat-sensitive items on or near the oven vent. These items can melt or ignite.
- Always handle oven racks when the oven is cool. Place oven racks in desired positions while the oven is cool. If a rack must be moved while the oven is hot, use extreme caution. Use potholders and grasp the rack with both hands to reposition. Do not let potholders contact the hot heating elements in the oven. Remove all bakeware and utensils before moving the rack.
- Do not use a broiler pan without its insert. Broiler pans and inserts allow dripping fat to drain away from the high heat of the broiler. Do not cover the broiler insert with aluminum foil; exposed fat and grease could ignite.
- Do not use aluminum foil or other protective liners to line the oven bottom. Only use aluminum foil as recommended in this manual. Improper installation of these liners may result in risk of electric shock or fire.
- Do not cook food on the oven bottom. Always cook in proper bakeware and always use the oven racks

IMPORTANT

Proper Installation—Be sure your appliance is properly installed and grounded by a qualified technician in accordance with the National Electrical Code ANSI/NFPA No. 70 latest edition and local electrical code requirements. In Canada, install in accordance with CSA Standard C22.1, Canadian Electrical code, Part 1, and local electrical code requirements. Install only per installation instructions provided in the literature package for this oven.

User Servicing—Do not repair or replace any part of the appliance unless specifically recommended in the manuals. All other servicing should be done only by a qualified technician. This reduces the risk of personal injury and damage to the oven.

Ask your dealer to recommend a qualified technician and an authorized repair service. Know how to disconnect the power to the oven at the circuit breaker or fuse box in case of an emergency.

Never modify or alter the construction of an oven by removing the leveling legs, panels, wire covers, anti-tip brackets/screws, or any other part of the oven.

Remove the oven door from any unused oven if it is to be stored or discarded.

Do not attempt to operate the oven during a power failure. If the power fails, always turn off the oven. If the oven is not turned off and the power resumes, the oven will begin to operate again. Once the power resumes, reset the clock and oven function.

Cold temperatures can damage the electronic control. When using this appliance for the first time, or when the appliance has not been used for an extended period of time, be sure the appliance has been in temperatures above 32°F (0°C) for at least 3 hours before turning on the power to the appliance.

Be sure to have an appropriate foam-type fire extinguisher available, visible, and easily accessible located near the appliance.

IMPORTANT SAFETY INSTRUCTIONS

IMPORTANT INSTRUCTIONS FOR CLEANING YOUR OVEN

CAUTION

Before manually cleaning any part of the oven, be sure all controls are turned off and the oven is cool. Cleaning a hot oven can cause burns.

- Clean the oven regularly to keep all parts free of grease that could catch fire. Do not allow grease to accumulate.
- Always follow the manufacturer's recommended directions for use of kitchen cleaners and aerosols. Be aware that excess residue from cleaners and aerosols may ignite causing damage and injury.
- Clean ventilating hoods frequently. Grease should not be allowed to accumulate on the hood or filter. Follow the manufacturer's instructions for cleaning hoods.

SELF CLEANING OVENS

- Use the self clean cycle to clean only the parts listed in this manual. Before using self clean, remove the broiler pan, any food, utensils, and bakeware from the oven. Remove oven racks unless otherwise instructed.
- Do not use oven cleaners. No commercial oven cleaner, oven liner, or protective coating of any kind should be used in or around any part of the oven.
- Do not clean the oven door gasket. The door gasket is essential for a good seal. Do not rub, damage, or move the gasket.
- Some birds are extremely sensitive to the fumes given off during the self clean cycle of any oven. Move birds to another well-ventilated room.

WARNING

Avoid fire hazard or electrical shock. Do not use an adapter plug or an extension cord, or remove grounding prong from the power cord. Failure to follow this warning may cause serious injury, fire, or death.

See the installation instructions packaged with this appliance for complete installation and grounding instructions.

GROUNDING INSTRUCTIONS

Do not use an adapter plug or an extension cord, or remove grounding prong from the power cord. Failure to follow this warning may cause serious injury, fire, or death.

For personal safety, this appliance must be properly grounded.

For models factory-equipped with a power cord:

For maximum safety, the power cord must be plugged into an electrical outlet that is the correct voltage, is correctly polarized, and properly grounded in accordance with local codes.

For ovens to be wired into a junction box:

It is the personal responsibility of the consumer to have the appropriate outlet with the correct, properly grounded wall receptacle (junction box) installed by a qualified electrician. Follow carefully the installation instructions packaged with this appliance for complete installation and grounding instructions.

BEFORE SETTING OVEN CONTROLS

Oven vent location

The oven vent is located under the control panel. When the oven is on, warm air passes through this vent. This venting is necessary for proper air circulation in the oven and good baking results. Steam or moisture may appear near the oven vent, this is normal. Do not block oven vent.

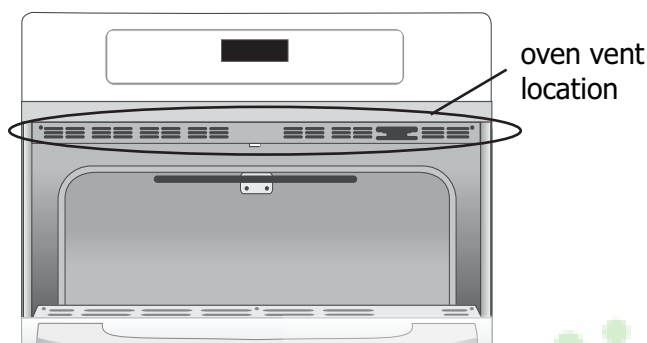

Figure 1: Do not block oven vent location

! CAUTION

Always use pot holders or oven mitts when using the oven. When cooking, the oven interior and exterior, as well as the oven racks, will become very hot which can cause burns.

! WARNING

Protective Liners — Do not use aluminum foil to line the oven bottom. Only use aluminum foil as recommended in this manual. Improper installation of these liners may result in risk of electric shock or fire.

Removing, replacing, and arranging flat or offset oven racks

To arrange - Always arrange the oven racks when the oven is cool (prior to operating the oven).

To remove - Pull the oven rack straight forward until it reaches the stop position. Lift up front of oven rack slightly and slide out.

To replace - Place the oven rack on the rack guides on both sides of oven walls. Tilt the front of oven rack upward slightly and slide the oven rack back into place. Be sure oven racks are level before using.

Type of oven racks

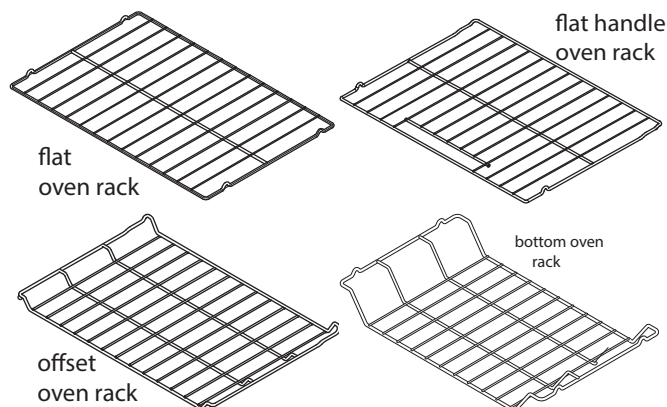

Figure 2: Oven rack types

Oven Rack Descriptions:

- Flat oven racks (or the flat handle oven rack) may be used for most cooking needs and may be placed in most oven rack positions.
- The offset oven rack (some models) provides additional stepdown positions from the standard flat rack design. The offset design positions the base of the rack about half of a rack position lower than the flat rack and may be used in most oven rack positions.

Air circulation in the oven

For best air circulation when baking, allow a space of 2 inches (5 cm) around the cookware for proper air circulation. Be sure pans and cookware do not touch each other, the oven door, sides, or back of the oven cavity.

Hot air must be able to circulate evenly around the bakeware to reach the food and give the best baking results.

OVEN CONTROLS



Frigidaire Professional (shown above) Frigidaire Gallery (shown below)



1. **Bake** — Use to select the bake cooking feature.
2. **Broil** — Use to select broil cooking feature.
3. **Convect** — Use to select between Convection Bake, Convection Roast, and Convection Broil (some models)
4. **Warm** — Use setting to keep food and dishes warm.
5. **Slow Cook** — Use for cooking foods requiring long cooking times with lower temperatures. **(Professional model)**
6. **Power Plus Preheat/Quick preheat** — Use to quickly raise oven to preheat temperature.
7. **Delay Start** — Use to program a Delayed Time Bake or Delayed Self Cleaning Cycle start time.
8. **Convect Convert** — Use to convert regular recipe temperature to a convection temperature.
9. **Bake Time** — Use to enter the length of baking time.
10. **Probe** — Use to monitor internal temperature of food.
11. **Steam Clean** — Use to start steam cleaning feature.
12. **Self Clean** — Use to set a 2, 3, or 4 hour self clean.
13. **Oven Light** — Use to turn the oven light on and off.
14. **Oven Lockout** — Use to lock the oven door and the control panel.
15. **Start** — Use for starting all cooking features.
16. **Off** — Use to cancel any baking function.
17. **Timer On-Off** — Use to set or cancel timer. The timer does not start or stop the cooking process.
18. **My Favorites** — Use to set and record favorite recipe times and temperatures. **(Professional model)**
19. **Set Clock** — Use to set the time of day.
20. **Numeric keys** — Use to enter temperatures and times.

OVEN CONTROLS

Setting The Clock

The **set clock** key is used to set the clock. The clock may be set for 12 or 24 hour time of day operation. The clock was preset at the factory for 12 hour operation. When the range is first plugged in, or when the power supply to the range has been interrupted, the timer in the display will flash. To set the clock (example below for 1:30)

1. Press **set clock**. **CLO** will appear in the display.
2. Press **1 3 0** to set the time of day to 1:30. **CLO** will stay in the display.
3. Press **start**. **CLO** will disappear and the clock will start.

The clock must be set for the oven to operate. If you have a power interruption of any kind remember to set the clock when power is restored. When programming a delay start make sure the clock is set to the correct time of day.

Changing Between 12 or 24 Hour Time of Day Operation

1. Press and hold **set clock** for 6 seconds. **CLO** will appear in the display.
2. Continue holding the key until **12Hr dAY** or **24Hr dAY** appears in the display and the control beeps once.
3. Press **self clean** to switch between the 12 and 24 hour time of day display. The display will show either **12Hr dAY** or **24Hr dAY**.
4. Press **start** to accept the change or press **off** to reject the change.
5. Reset the correct time as described above in **Setting the Clock** instructions. If the 24 hour time of day mode was chosen, the clock will display time from 0:00 through 23:59 hours.

Setting Continuous Bake or 6 Hour Energy Saving

The **timer** and **self clean** keys control the Continuous Bake or 6 Hour Energy Saving features. The oven control has a factory preset 6 Hour Energy Saving feature that will shut off the oven if the oven control is left on for more than 6 hours. The oven can be programmed to override this feature for Continuous Baking.

Setting the control for Continuous Bake or 6 Hour Energy Saving:

1. Press and hold **timer** for 6 seconds. After 6 seconds **6Hr OFF** or **StAY On** will appear in the display and the control will beep once.
2. Press **self clean** to switch between the 6 Hour Energy Saving and Continuous Bake features.

3. Press **start** to accept the change (display will return to time of day) or press **off** to reject the change.

6Hr OFF indicates the control is set for the 6 Hour Energy Saving mode. **StAY On** indicates the control is set for the Continuous Bake feature.

Setting Temperature Display in Fahrenheit or Celsius

The **broil** and **self clean** keys control the Fahrenheit or Celsius temperature display modes. The oven has been preset at the factory to display in Fahrenheit.

To change display from Fahrenheit to Celsius or Celsius to Fahrenheit:

1. To tell if the display is set for Fahrenheit or Celsius press **broil** and hold it for 6 seconds; **550°** will appear and **broil** will flash in the display and a beep will sound. If **FAHrht** appears, the display is set to show temperatures in Fahrenheit. If **CELSIUS** appears, the display is set to show temperatures in Celsius.
2. Press **self clean** to switch between Fahrenheit or Celsius display modes. The display will show either **FAHrht** or **CELSIUS**.
3. Press **start** to accept the change or press **off** to reject the change.

Setting Silent Control Operation

The **delay start** and **self clean** keys control the Silent Control operation feature. This feature allows the oven control to be operated with or without out sounds or beeps.

To change control from normal sound operation to silent control operation

1. To set range for normal or silent operation press and hold **delay start**. **-- --** will appear and **DELAY** will flash in the display. After 6 seconds **bBEEP On** or **bBEEP OFF** will appear in the display.
2. Press **self clean** to switch between normal sound operation and silent operation mode. The display will show either **bBEEP On** or **bBEEP OFF**. If **bBEEP On** appears, the control will operate with normal sounds and beeps. If **bBEEP OFF** appears, the control is in the silent operation mode.
3. Press **start** to accept the change or press **off** to reject the change. **Note:** The control will always beep at the end of a minute timer and will beep when a set temperature has been reached, even if the control is set to silent operation.

OVEN CONTROLS

Setting My Favorite Recipe (Professional model)

The **my favorite** feature allows the user to save a recipe to be recalled at any time. The recipe may be for any baking temperature between 170°F (77°C) to 550°F (288°C). Once saved, the user need only to select **my favorite** and the baking function will start automatically with the pre-programmed recipe. The oven can recall a cooking sequences from its internal memory, which is easily accessible from one touch of **my favorite**. This feature can be used with bake, convection bake, convection roast and preheat.

To save a My Favorite (example is a 450°F Bake for 30 minutes):

1. Press **bake**. The default temperature will appear in the display.
2. Enter temperature needed; **4 5 0**. Press **start**.
3. Press **bake time**.
4. Enter time needed; **3 0**. Press **start**.
5. Press and hold for 3 seconds **my favorite**. The ♥ icon will be shown to confirm your setting has been saved.

Setting Minute Timer

The **timer on-off** key controls the minute timer and serves as an extra timer in the kitchen that will beep when the set time has run out. It does not start or stop cooking. The minute timer can be used during any of the other oven control functions.

To set the Minute Timer (example for 5 minutes)

1. Press **timer on-off**. -- -- will appear and **TIMER** will flash in the display.
2. Press the number keys to set the desired time in the display. Press **start**. The time will begin to count down and **TIMER** will stay in the display.

Note: If **start** is not pressed the timer will return to the time of day after 25 seconds.



When the time expires, **End** and **TIMER** will show in the display. The clock will sound with 3 beeps every 30 seconds until **timer on-off** is pressed.

To cancel the Minute Timer before the set time expires, Press **timer on-off**.

Setting Oven Lockout Feature

The  key controls the Oven Lockout. When active, this feature automatically locks the oven door, preventing the oven from being turned on. It does not affect the clock, Timer, or the interior oven lights.

To activate the Oven Lockout feature:

1. Press and hold  for 3 seconds.
2. After 3 seconds **Loc** will appear, a tone will sound and  icon will flash in the display. Once locked, the lock icon will stop flashing and remain visible with the **Loc**.

To reactivate normal oven operation:

1. Press and hold  for 3 seconds. After 3 seconds a tone will sound and the lock icon will flash in the display until the oven door has completely unlocked.
2. The oven is now fully operational.

Oven Light

The oven is equipped with two oven lights. The oven lights will turn on automatically, when the oven door is opened.

The oven light may be turned on when the door is closed by using the oven light key located on the control panel. The oven light key will toggle the lights at full intensity.

To toggle the Oven Lights on and off:

1. Press **oven light** .

The interior oven lights are covered with a glass shield held by a wire holder. The glass shield must be in place whenever the oven is in use.

To change the interior oven lights, see "Changing the oven light" in the **Care & Cleaning** section.

Setting Bake

The **bake** key controls normal baking. If rapid preheating is preferred, refer to the **Preheat** feature for instructions. The oven can be programmed to bake at any temperature from 170°F to 550°F.

Baking Tips:

- Preheat your oven before using the bake mode.
- During preheat, the 3 elements and the convection fan are used in cycle to quickly heat the oven.
- Use only one rack and center the pans as much as possible on rack 2 or 3.
- If using two racks, place the oven racks in positions 2 and 4.
- Allow 2" to 4" (5,1 to 10,2cm) around the utensil(s) for proper air circulation.
- Be sure the pans do not touch each other, the door, sides or back of the oven.

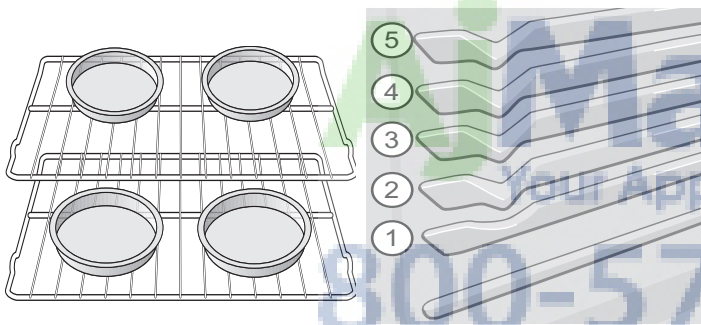

Figure 3: Pan spacing and rack positions

To set the Bake Temperature to 375°F:

1. Arrange interior oven racks.
2. Press **bake**, **350** will appear in the display.
3. Press **3 7 5**.
4. Press **start**. The actual temperature will be displayed. A beep will sound once the oven temperature reaches 375°F and the display will show **375°**.
5. Place food in the oven.

NOTE

Pressing **off** will stop the feature at any time.

During the first rise of temperature, the convection fan will activate to allow the oven to reach its target temperature faster.

To change the bake temperature (example: changing from 375°F to 425°F):

1. After the oven has already been set to bake at 375°F and the oven temperature needs to be changed to 425°F, press **bake** and **375** will appear in the display.
2. Press **4 2 5**. **BAKE** will continue to flash and **425°** will appear in the display.
3. Press **start**. The actual temperature will be displayed.

Setting Preheat

The **preheat** keys control the **PowerPlus™ preheat/Quick preheat** features. Use this feature when recipes call for preheating. The oven can be programmed to preheat at any temperature between 170°F to 550°F.

To set the preheat temperature for 375°F:

1. Arrange the interior oven racks.
2. Press **preheat**. **350** will appear in the display. If a preheat of 350°F is needed, press **start**.
3. Press **3 7 5**.
4. Press **start**. **PREHEAT** will be displayed while the oven is preheating along with the set temperature.
5. Press **off** when baking is complete or to turn off the preheat feature.

NOTE

After the oven has reached the desired temperature (this example, 375°F) the control will beep and the **PREHEAT** light will turn off, the bake feature will activate and oven target temperature will be displayed. The preheat temperature can only be changed while the **PREHEAT** message is displayed.

To change preheat temperature while oven is preheating (ex: changing from 375°F to 425°F):

If it is necessary to change the preheat temperature while the oven is preheating to the original temperature:

1. While preheating, press **preheat**. **375** will appear in the display.
2. Enter the new preheat temperature. Press **4 2 5**.
3. Press **start**. **PREHEAT** will appear in the display.

Note: A beep will sound once the oven temperature reaches 425°F and the display will show **425°**.

When baking is complete press **off**.

OVEN CONTROLS

Setting Convection Bake

This mode of cooking enables you to obtain the best culinary results when baking with multiple pans and racks. Multiple rack baking may cook faster and more evenly with convection baking by using the three elements and a fan to circulate the oven's heat evenly and continuously within the oven. The oven can be programmed for convection baking at any temperature between 170°F to 550°F with a default temperature of 350°F.

Convection Baking Tips:

- Always preheat your oven before using the convection bake mode.
- During preheat, the 3 elements and the convection fan are used in cycle to quickly heat the oven.
- If your recipe cooking temperature has already been converted for convection baking there is no need to reduce your oven temperature. If your recipe has not had the temperature converted for convection baking you can easily reduce using the Convect Convert feature.
- Use tested recipes with times adjusted for convection baking when using this mode. Time reductions will vary depending on the amount and type of food to be cooked.
- When using convection bake with a single rack, place oven rack in position 2 or 3. Cooking on multiple racks, place in positions 2 and 4 or 1, 3 (offset rack) and 4.
- Most bake goods (except cakes) should be baked on pans with no sides or very low sides to allow heated air to circulate around the food.
- Food baked on pans with a dark finish will cook faster.

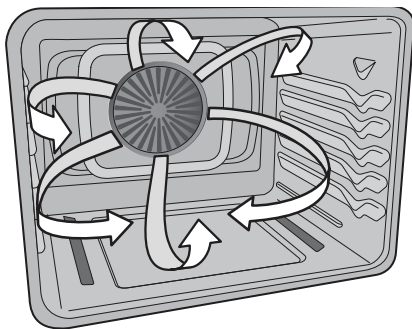

Figure 4: Air circulation in convection function

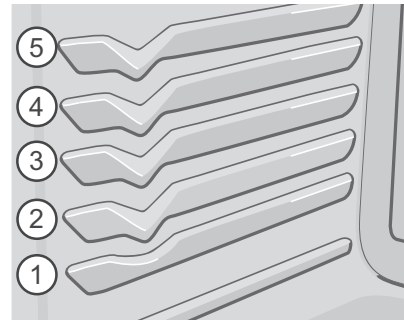

Figure 5: Oven rack positions

To set the oven for Convection Bake and temperature to 375°F:

1. Arrange interior oven racks.
2. Press **convect**. **CONVECT** and **BAKE** will flash and **350** will appear in the display.
3. Press **3 7 5**. **CONVECT** and **BAKE** will keep flashing and **375°** will appear in the display.
4. Press **start**. The actual oven temperature and the fan icon will be displayed. A beep will sound once the oven temperature reaches 375°F and the display will show **375°**, **CONVECT**, **BAKE** and the fan icon.
5. Place food in the oven.

NOTE

The convection fan will start when the oven is set for **convect bake**. The display will show an icon of rotating fan within a square. This rotating fan icon indicates when the convection fan is operating. The bake, broil and convection elements will cycle for better heat distribution.

OVEN CONTROLS

Setting Broil

This mode is best for meats, fish and poultry up to 1" thick. Broiling is a method of cooking tender cuts of meat by direct heat under the broil element of the oven.

WARNING

Should an oven fire occur, leave the oven door closed and turn off the oven. If the fire continues, throw baking soda on the fire or use a fire extinguisher. Do not put water or flour on the fire. Flour may be explosive and water can cause a grease fire to spread and cause personal injury.

The **broil** key controls the broil feature. The oven can be programmed to broil at any temperature from 400°F to 550°F with a default temperature of 550°F.

To set a Broil of 500°F:

1. Place the broiler pan insert on the broiler pan. Then place the food on the broiler pan insert. Do not use the broiler pan without the insert. Do not cover the broiler insert with foil. The exposed grease could ignite.
2. Arrange the interior oven rack and place the broiler pan on the rack. Be sure to center the broiler pan directly under the broiler element.
3. Preheat for 2 minutes before broiling.
4. Press **broil**. **550** will appear in the display
5. Press **5 0 0**. If a lower broil temperature is desired (minimum broil temperature setting is 400°F), press the desired temperature before continuing to step 5.

6. Press **start**. The oven will begin to broil. **500°** will appear in the display.
7. Broil on one side until food is browned; turn and cook on the second side. Season and serve.
8. To stop broiling press **off**.

The optional broil pan and broil pan insert used together allow dripping grease to drain and be kept away from the high heat of the oven broiler. Available at frigidaire.com.

For Broiling recommendations see [Table 1](#)

Broiling Tips:

- For optimum browning, preheat the broil element for 5 minutes. Broil one side until the food is browned; turn and cook on the second side. Season and serve.
- Always use a broiler pan and its cover when broiling. It allows the dripping grease to be kept away from the high heat of the broil element ([Figure 6](#)).
- Always pull the rack out to the stop position before turning or removing food.
- If using a Searing Grill (frigidaire.com), preheat the grill for 5 to 10 minutes before placing your meat.
- Do not use the broil pan without an insert.
- Do not cover the broil pan insert with foil. The exposed grease could catch fire.

Table 1: Recommended broil settings

Food item	Rack Position	Temperature	Cook time		Doneness
			1st side	2nd side	
Steak 1" thick	3rd or 4th	550°F	6:00	4:00	Rare
	3rd or 4th	550°F	7:00	5:00	Medium
Pork Chops 3/4 "thick	3rd or 4th	550°F	8:00	6:00	Well
Chicken - Bone In	3rd	450°F	20:00	10:00	Well
Chicken Boneless	3rd or 4th	450°F	8:00	6:00	Well
Fish	3rd	500°F	13:00	-	Well
Shrimp	3rd	550°F	5:00	-	Well
Hamburger 1" thick	3rd or 4th	550°F	9:00	7:00	Medium
	3rd or 4th	550°F	10:00	8:00	Well

OVEN CONTROLS

⚠ WARNING

If an oven fire occurs, leave oven door closed and turn off oven. If fire continues throw baking soda on fire or use a fire extinguisher. Do not put water or flour on the fire. Flour may be explosive and water could cause a grease fire to spread and cause injury.

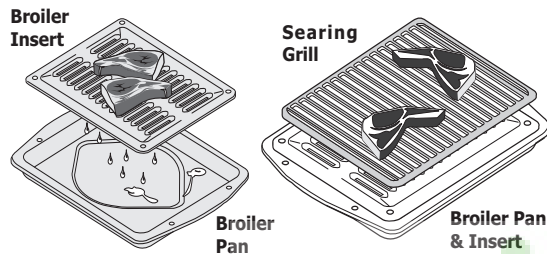

Figure 6: Optional broiling accessories

Setting Convection Broil

Use this mode for thicker cuts of meat, fish and poultry. Convection broiling gently browns the exterior and seals in the juices. Convection broiling uses the broil element and a fan to circulate the oven's heat evenly and continuously within the oven. The oven can be programmed for convection broiling at any temperature between 300°F to 550°F with a default temperature of 550°F.

Convection Broiling Tips:

- For optimum browning, preheat the broil element for 5 minutes.
- Broil one side until the food is browned; turn and cook on the second side. Season and serve..
- Always use a broiler pan and its grid when broiling (available by mail order). It allows the dripping grease to be kept away from the high heat of the broil element.
- Do not use the broil pan without the insert (available by mail order). Do not cover the broil pan insert with foil. The exposed grease could catch fire.
- If using a searing grill (available by mail order), preheat the grill for 5 to 10 minutes before placing your meat.
- Convection broiling is generally faster than conventional broiling. Check for doneness at the minimum recommended time.

To set a Convection Broil Temperature of 500°F:

1. Arrange oven racks first. Press **convect**; **350** will be displayed; **CONVECT** and **BAKE** will flash.
2. Press **convect** again; **350** will be displayed; **CONVECT** and **ROAST** will flash.
3. Press **convect** again; **550** will be displayed; **CONVECT** and **BROIL** will flash.
4. Enter **5 0 0** using the number keys
5. Press **start**; **500**, **CONVECT**, **BROIL** and the fan icon will be displayed. After 5 minutes of preheat, place food in the oven.

⚠ CAUTION

Always use this cooking mode with the oven door closed or the convection fan will not turn on.

Setting Bake Time

Use **bake time** when setting the oven to cook for a specific length of time and shut off automatically when the time has elapsed. When cooking time ends, the oven will shut off and will beep. This feature can be used with bake, slow cook, convection bake, and convection roast cooking modes.

To program the oven to begin baking immediately and to shut off automatically (example: Bake at 350°F for 30 minutes):

1. Be sure the clock is set for the correct time of day.
2. Arrange interior oven rack(s) and place the food in then oven.
3. Press **bake**, **350** will appear in the display.
4. Press **start**. The actual oven temperature will appear in the display.
5. Press **bake time**. -- -- will appear in the display.
6. Enter the desired baking time by pressing **3 0**.
7. Press **start**. Once the Timed Bake feature has started, the current time of day will appear in the display.

When the timed bake finishes:

End and the time of day will show in display. The oven will shut off automatically. The control will beep 3 times. The control will continue to beep 3 times every 30 seconds until **off** is pressed

Setting Convection Convert

The **convect convert** key is used to automatically convert a standard baking recipe for convection baking. When set properly, this feature is designed to display the actual converted (reduced) temperature in the display. Convection convert may only be used with convection bake cooking. It can be used with **delay start** and **bake time**.

If convection conversion is used with the bake time and delay start features, **CF** (check food) will be displayed when 75% of the bake time is complete. At this time the oven control will sound 3 long beeps at regular intervals until baking had finished. When the bake time has completely finished the control will display **End** and beep at regular intervals until **off** is pressed.

NOTE

To use this feature with the bake time option, **bake time** must be pressed before **convect convert** is pressed.

To set the oven for Convection Bake with a standard baking recipe temperature of 400°F:

1. Arrange interior oven racks.
2. Press **convect**. **CONVECT** and **BAKE** will flash and **350** will appear in the display.
3. Press **4 0 0**. **CONVECT** and **BAKE** will keep flashing and **400°** will appear in the display.
4. Press **convect convert**. When the convection convert key is pressed, the oven will start heating. The temperature displayed will be 25°F lower than what it used to be. The actual oven temperature and the fan icon will be displayed. A beep will sound once the oven temperature reaches 375°F and the display will show **375°**, **CONVECT**, **BAKE** and the fan icon.
5. Place food in the oven.

Setting Convection Roast

This mode is best for cooking tender cuts of beef, lamb, and pork. Use this mode when cooking speed is desired. Convection roasting gently browns the exterior and seals in the juices. Convection roasting uses the hidden bake element, the hidden convection element, the broil element and a fan to circulate the oven's heat evenly and continuously within the oven. The oven can be programmed for convection roasting at any temperature between 170°F to 550°F with a default temperature of 350°F.

Convection Roasting Tips:

- Use a broiler pan, grid, and roasting rack (available by mail order). The broiler pan will catch grease spills and the grid will help prevent spatters. The roasting rack will hold the meat.
- Place an offset oven rack on rack position 1.
- No preheat is needed in convection roast.
- Make sure the roasting rack is securely seated on the grid in the broiler pan. The roasting rack fits on the grid allowing the heated air to circulate under the food for even cooking and helps to increase browning on the underside.
- There is no need to reduce the convection temperature or to use the convect convert feature with this cooking mode.
- Do not use the broiler pan without the grid or cover the grid with aluminum foil.
- Always pull the rack out to the stop position before removing food.
- Position food (fat side up) on the roasting rack.

To set a Convection Roast Temperature of 375°F:

1. Arrange oven racks and place food in the oven.
2. Press **convect**. **350** will be displayed; **CONVECT** and **BAKE** will flash.
3. Press **convect** again. **350** will be displayed; **CONVECT** and **ROAST** will flash.
4. Enter the desired roasting temperature using the number keys **3 7 5**.
5. Press **start**. The actual oven temperature will be displayed, **CONVECT**, **ROAST** and the fan icon will be displayed. The bake, broil and convection elements will also cycle for a better heat distribution.

OVEN CONTROLS

Setting Delay Start

Bake, convection bake, bake time and delay start keys control the delayed time bake feature. The automatic timer of the delayed time bake will turn the oven **on and off** at the time you select in advance.

CAUTION

Use caution with the **delay start** features. Foods that can easily spoil such as milk, eggs, fish, meat or poultry, should be chilled in the refrigerator first. Even when chilled, they should not stand in the oven for more than 1 hour before cooking begins, and should be removed promptly when cooking is completed. Eating spoiled food can result in sickness from food poisoning.

To program the oven for a delayed Bake start time (example: baking at 375°F, starting at 5:30):

1. Be sure that the clock is set with the correct time of day.
2. Arrange interior oven rack and place the food in the oven.
3. Press **bake**. **350** will appear in the display.
4. Enter the desired temperature; pressing **3 7 5**.
5. Press **start**. The actual oven temperature will appear in the display.
6. Press **delay start**.
7. Enter the desired start time; pressing **5 3 0**.
8. Press **start**. When delayed time bake starts, the set oven temperature will appear, **delay, BAKE** and the current time of day will appear in the display. When the desired start time is reached, the actual oven temperature appears in display and **delay** disappears. Oven starts to bake at the previously selected temperature.

Setting Warm

Warm is best for keeping oven baked foods warm for serving after cooking has finished. The **warm** feature will maintain an oven temperature of 170°F (77°C) and will keep oven baked foods warm for serving up to 3 hours after cooking.

After 3 hours the warm feature will shut the oven off. The warm feature may be used without any other cooking operations or can be set to turn on automatically after a **bake time** or **delayed bake time**.

Warm Tips:

- Always start with hot food. Do not use the **warm** feature to heat cold food.
- Food in heat-safe glass and glass ceramic containers may need higher temperature settings compared to food in regular containers.
- Avoid repeated openings of the oven, it will allow hot air to escape and the food to cool.
- Aluminum foil may be used to cover food to increase moisture content.

To set warm:

1. Arrange interior oven racks and place food in oven.
2. Press **warm**. **HLd** will appear in the display. Press **start**. The oven icon will appear in the display. If no key is touched within 25 seconds the request to turn on Keep Warm feature will be cancelled.
3. To turn off the **warm** at any time press **off**.

To set warm to turn on automatically:

1. Arrange interior oven racks and place food in oven. Set the oven properly for Bake Time (see "Setting Bake Time" on [page 14](#)) or Delay Start (see "Setting Delayed Start" on [page 16](#))
2. Press **warm**. If no key is touched within 25 seconds, the request to turn on warm feature will be cleared.
3. Press **start**. **HLd** will disappear and the temperature will be displayed. The warm mode is set to turn on automatically after timed bake has finished.
4. To turn the warm feature off at any time press **off**.

Note: Pressing **off** will stop the feature at any time.

Table 2: Minimum and Maximum Control Settings

All of the features listed below have minimum and maximum time or temperature settings that may be entered into the control. An ENTRY acceptance beep will sound each time a control key is touched (the acceptance beep on the Oven Lockout key is delayed 3 seconds).

An ENTRY ERROR tone (3 short beeps) will sound if the entry of the temperature or time is below the minimum or above the maximum settings for the feature.

FEATURE		MINIMUM TEMP. /TIME	MAXIMUM TEMP. /TIME
PREHEAT		170°F/77°C	550°F/288°C
BAKE		170°F/77°C	550°F/288°C
BROIL		400°F/205°C	550°F/288°C
CONVECTION BAKE		170°F/77°C	550°F/288°C
CONVECTION ROAST		170°F/77°C	550°F/288°C
CONVECTION BROIL		400°F/205°C	550°F/288°C
SLOW COOK		Lo (225°F/108°C)	Hi (275°F/135°C)
PROBE		140°F/60°C	210°F/99°C
TIMER	12 Hr. Mode	0:01 Min.	11:59 Hr./Min.
	24 Hr. Mode	0:01 Min	11:59 Hr./Min.
CLOCK TIME	12 Hr. Mode	1:00 Hr./Min.	12:59 Hr./Min.
	24 Hr. Mode	0:00 Min	23:59 Hr./Min.
DELAY START	12 Hr. Mode	1:00 Hr./Min.	12:59 Hr./Min.
	24 Hr. Mode	0:00 Min	23:59 Hr./Min
BAKE TIME	12 Hr. Mode	0:01 Min	5:59 Hr./Min.
	24 Hr. Mode	0:01 Min	5:59 Hr./Min.
SELF CLEAN TIME		2 hours	4 hours

OVEN CONTROLS

Cooking With Meat Probe

Use the probe feature for best results when cooking foods such as roasts, hams or poultry. This feature also works well with other foods such as meat loaf and casseroles.

For meats like poultry and roasts, using a probe to check internal temperature is the safest method to ensure properly cooked food.

The probe feature, when set correctly, will signal an alert when the internal food temperature reaches the desired set "target" temperature.

When active, the probe displays the internal food temperature which is visible in the display during the cooking process. This eliminates any guesswork or the need to open the oven door to check the thermometer.

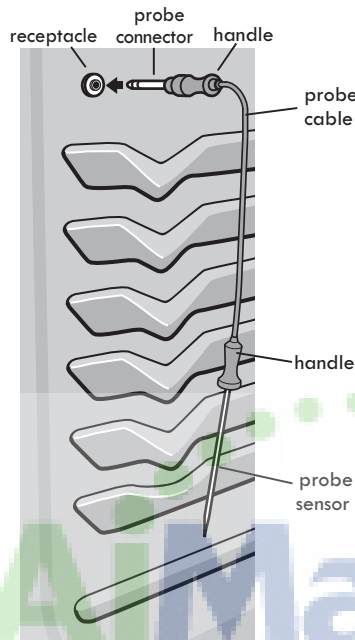

Figure 7: Probe shown with its components

NOTE

On some models the probe receptacle can be found on the top of the oven cavity near the front.

CAUTION

To avoid the possibility of burns after cooking with the probe, use care when disconnecting the probe from the receptacle or food. The probe may be hot. Be sure to always use a pot holder to protect hands.

IMPORTANT

- To avoid damaging the probe, do not use kitchen utensils such as tongs to pull on the probe cable or handles. Always insert and remove the probe using the provided handles (Figure 7) and always use a pot holder to protect hands from possible burns.
- Do not store the probe inside the oven. Always remove the probe from the oven when finished.
- Use only the original probe provided with this appliance. Connecting any other probe or device into the probe receptacle could result in damage to the oven control, electronics and the receptacle.
- Before starting self clean, double check that the probe is removed from the oven interior. The high temperatures generated by self clean may damage or destroy the probe.
- To avoid damaging the probe, defrost frozen foods completely before inserting the probe.

Proper placement of probe in food:

- Always insert the probe so that the probe tip rests inside at the center of the thickest part of meat or food (Figure 8). For best results, do not allow the probe temperature sensor to contact bone, fat, gristle or the cookware.

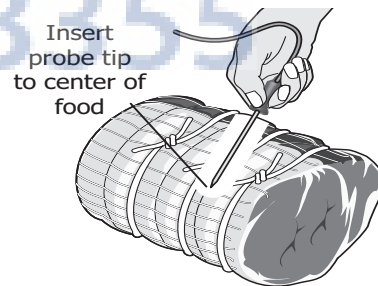

Figure 8: Probe in thickest area of food

- For bone-in ham or lamb, insert the probe into the center of lowest large muscle or joint. For dishes such as meat loaf or casseroles, insert the probe into center of food. When cooking fish, insert meat probe just above the gill.
- For whole poultry or turkey, fully insert the probe sensor into the thickest part of inner thigh, just below the leg

OVEN CONTROLS

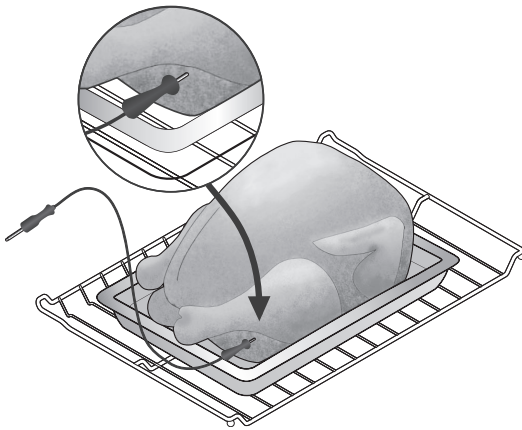

Figure 9: Probe in thickest part of thigh

Choosing a setting for how the oven will operate once the probe reaches the target temperature:

The oven is preset to automatically stop cooking and start the keep warm feature when probe sensor reaches the target temperature. This may be set to continue cooking if desired. Setting your options once the probe reaches the target temperature must be done when the oven is inactive. The probe is not required to be connected to the probe receptacle when setting this option.

To set the oven to continue cooking after reaching the target temperature:

1. Press **probe** key and hold for 6 seconds.
2. Press **self clean** key and toggle until **Continu:** appears (Figure 10) then press **start** to accept.



Figure 10: Probe set to continue cooking

To set the oven to automatically stop cooking and start keep warm once reaching target temperature:

1. Press **probe** key and hold for 6 seconds.
2. Press **self clean** key and toggle until **CAnCEL** appears (Figure 11) then press **start** to accept.



Figure 11: Probe set to cancel cooking

To set probe:

1. Insert the probe into the food. Place prepared food on the desired oven rack position and slide into the oven.
2. Plug the connector end of the probe all the way into the probe receptacle while the oven is cool. The receptacle is located on the upper left front oven cavity wall (Figure 7). On some models the receptacle is located on the top of the oven cavity near the front.
3. When the probe is set, an acceptance tone will sound, the probe icon will illuminate and the actual probe temperature appears in the display (Figure 12). Close the oven door.



Figure 12: Probe displaying actual temperature

4. Press **probe** key once. Enter the desired target food temperature using the numeric keys and set temperature for food type. The minimum setting is 140°F/ 60°C; the maximum is 210°F/99°C. Default is 170°F/77°C.
5. Press **start** to accept the target temperature.
6. Set for quick preheat, bake, convection bake, convection roast or convection convert and if necessary adjust the oven temperature accordingly.
7. The control will provide 3 beeps when the internal target temperature is reached. The oven will automatically change to a keep warm setting (**HLd** and the actual probe temperature will alternate in the display). **Warm** will maintain the oven temperature at 170° F(77°C) for 3 hours unless otherwise cancelled. To stop cooking at any time press **off**.

OVEN CONTROLS



Figure 13: Display showing probe error

If the error message **Prob ERR** displays (Figure 13), check to be sure that the probe connector is fully inserted into the receptacle. If the probe is fully inserted and the error message continues, the probe may be defective and need to be replaced. When **Prob ERR** displays, the oven control will not permit any oven feature to activate until corrected or the probe is removed. If the error message continues, remove the probe from the receptacle and oven.

Probe too hot message:

When the message **Prob... Too... Hot...** flashes in the display, the probe temperature has exceeded 250°F (121°C). If the probe is not removed this message may continue until the sensor reaches 300°F (149°C) or higher, at which time the oven will automatically turn off and display **Prob ERR** message. This message may be generated if the probe sensor is exposed to direct oven heat or the food internal temperature is over 250°F (121°C). Be sure the probe sensor is fully covered by the food or if the food is done, press cancel and remove food and probe from the oven.

NOTE

During cooking the internal food temperature will display by default. To review the target temperature press the **probe** key once. After 6 seconds the display will revert to the internal food temperature. To assure accuracy, do not remove the probe from the food or receptacle until the desired internal temperature is reached.

If the probe is active and the probe is removed from the receptacle only, the probe feature will cancel but the oven will continue to cook. If the probe is removed from the food only, the probe feature will remain active, and may eventually generate a **Probe Too Hot** message.

To change the target temperature while cooking, press the **probe** key once. Use the numeric keys to change the target temperature. Press the **start** key to accept any change. The probe feature can not be used with broil or self clean.

Table 3: USDA recommended minimum internal cooking temperatures

Food Type	Internal Temp.
Ground meat & meat mixtures	
Beef, Pork, Veal, Lamb	160°F (71°C)
Turkey, Chicken	165°F (74°C)
Fresh beef, veal, lamb	
Medium rare +	145°F (63°C)
Medium	160°F (71°C)
Well Done	170°F (77°C)
Poultry	
Chicken & Turkey, whole	165°F (74°C)
Poultry Breasts, Roasts	165°F (74°C)
Poultry Thighs, Wings	165°F (74°C)
Duck & Goose	165°F (74°C)
Stuffing (cooked alone or in bird)	165°F (74°C)
Fresh Pork	160°F (71°C)
Ham	
Fresh (raw)	160°F (71°C)
Pre-cooked (to reheat)	140°F (60°C)
Eggs & egg dishes	
Eggs	Cook until yolk and white are firm
Egg dishes	160°F (71°C)
Leftovers & Casseroles	165°F (74°C)

+ The U.S. Department of Agriculture states, "**Rare fresh beef is popular, but you should know that cooking it to only 140°F/60°C means some food poisoning organisms may survive.**" (Source: Safe Food Book, Your Kitchen Guide, USDA Rev. June 1985.)

Visit the USDA Food Safety and Inspection website at www.fsis.usda.gov

OVEN CONTROLS

Setting Slow Cook

The **slow cook** feature is best for cooking certain foods at lower temperatures for longer periods of time and works best for beef (ribs and brisket), pork roasts, and poultry dishes.

Slow Cook has two settings: Lo (225°F/108°C) and Hi (275°F/135°C). Both settings can be used with the following options:

- Cook Time
- Cook Time with End Time

Slow Cook Tips:

- Slow cooking meats may result in the outside of the meat turning dark; this is normal.
- Completely thaw all frozen foods before cooking
- When using a single oven rack, place in oven rack position 2 or 3.
- Position multiple racks to accommodate size of cooking utensils when cooking multiple food items.
- Add any cream or cheese sauces during the last hour of cooking.
- Do not frequently open the oven door or leave the oven door open when checking food items. The more heat that is lost, the longer the food will need to cook.
- Cover foods to keep them moist or use a loose or vented cover to allow foods to turn crisp or brown.
- Roasts may be left uncovered so browning can occur. Cook times will vary depending on the weight, fat content, bone & the shape of the roast.
- Preheating the oven is not necessary.

To set slow cook:

1. Position oven racks and cookware in oven. Close the oven door.
2. Press **slow cook**. **HI** will appear in the oven display indicating the default setting is for high heat. If a low setting is needed, press **Slow Cook** again to select the **LO** setting and release.
3. Press **start**
4. To stop cooking at any time press **off**.
5. Slow cook can be changed between **Hi** and **Lo** by pressing **slow cook** to toggle between the two settings.

Adjusting The Oven Temperature

The temperature in the oven is pre-set at the factory. When first using the oven, be sure to follow recipe times and temperatures. If you think the oven is cooking too hot or too cool for the temperature you select, you can adjust the actual oven temperature to be more or less than what is displayed. Before adjusting, test a recipe by using a temperature setting higher or lower than the recommended temperature. The baking results should help you to decide how much of an adjustment is needed.

To adjust the oven temperature higher:

1. Press **bake** for 6 seconds. **UPO 0** will appear in the display.
2. To increase the temperature use the number keys to enter the desired change (Example 30°F) **3 0**. The temperature may be increased as much as 35°F (19°C).
3. Press **start** to accept the temperature change and the display will return to the time of day. Press **off** to reject the change if necessary.

To adjust the oven temperature lower:

1. Press **bake** for 6 seconds. **UPO 0** will appear in the display.
2. To decrease the temperature use the number keys to enter the desired change (Example -30°F) **3 0** and then press **self clean**. The temperature may be decreased as much as 35°F (19°C).
3. Press **start** to accept the temperature change and the display will return to the time of day. Press **off** to reject the change if necessary.

NOTE

The oven temperature adjustments made with this feature will not change the self clean cycle temperature or the broil temperature.

The oven temperature adjustments are permanent and will stay forever in the unit memory unless you manually change it again. Even a power outage will not reset these changes. Follow the same procedure again if you wish to change it to a different setting.

OVEN CONTROLS

Setting the Sabbath Feature (For use on the Jewish Sabbath and Holidays)



The **bake time** and **delay start** keys are used to set the Sabbath feature. The Sabbath feature may only be used with the **bake** key. The oven temperature may be set higher or lower after setting the Sabbath feature (the oven temperature adjustment feature should be used only during Jewish Holidays), however the display will not visibly show or provide any audible tones indicating whether the change occurred correctly. Once the oven is properly set using Bake with the Sabbath feature active, the oven will remain continuously on until cancelled. This will override the factory preset 6-Hour Energy Saving feature.

If the oven light will be needed during the Sabbath, press **oven light** before activating the Sabbath feature. Once the oven light is turned on and the Sabbath feature is active, the oven light will remain on until the Sabbath feature is turned off. If the oven light needs to be off, be sure to turn the oven light off before activating the Sabbath feature.

To program the oven to begin baking immediately and activate the Sabbath feature (example: baking at 350°F):

1. Be sure that the clock is set with the correct time of day and place the food in the oven.
2. Press **bake**. **350°** appears in the display. Press **start**. The actual oven temperature appears in the display.
3. If you desire to set the oven control for a Bake Time or Delayed Bake Time do so at this time. Refer to **Bake Time / Delay Start** section for complete instructions. Remember the oven will turn off after using Bake Time or Delay Start and may only be used once during the Sabbath/Jewish Holidays. The maximum delayed start bake time is 11 hours & 59 minutes.
4. The oven will turn on and begin heating.
5. Press and hold both the **bake time** and **delay start** keys for at least 3 seconds. **SAb** will appear in the display. Once **SAb** appears in the display the oven control will no longer beep or display any further changes and the oven is properly set for the Sabbath feature. The oven may be turned off at any time by first pressing **off** (this will turn the oven off only). To turn off the Sabbath feature press and hold both the **bake time** and **delay start** keys for at least 3 seconds. **SAb** will disappear from the display.

▶ IMPORTANT

It is not advised to attempt to activate any other program feature other than **bake** while the Sabbath feature is active. Only the following keys will function after setting the Sabbath feature; **0 to 9, bake, start & off**. All other keys should not be used once the Sabbath feature is properly activated.

📌 NOTE

You may change the oven temperature once baking has started by pressing **bake**, the numeric keys for the temperature you want (example for 425°C press **4 2 5**) and then pressing **start** twice (for Jewish Holidays only). Remember that the oven control will no longer beep or display any further changes once the oven is set for the Sabbath feature.

Should you experience a power failure or interruption, the oven will shut off. When power is returned, **SF** (Sabbath Failure) will be displayed and the oven will not turn back on automatically. If your food was nearly fully cooked, you may allow the trapped heat in the oven to finish the cooking process. Otherwise, you should remove the food when the power failure occurs, because you may only start the oven once during the Sabbath/Jewish Holidays. After the Sabbath observance turn off the Sabbath feature and the oven may be used with all normal functions.

After the Sabbath observance turn off the Sabbath feature. Press and hold both the **bake time** and **delay** keys for at least **3 seconds**. **SAb** will disappear from the display and the oven may be used with all normal functions. For further assistance, guidelines for proper usage, and a complete list of models with the Sabbath feature, please visit the web at star-k.org.

OVEN CONTROLS

Steam Clean

The **steam clean** feature offers a chemical-free and time-saving method to assist in the routine cleaning of your oven. Steam clean may be used before manually cleaning the oven to help loosen soils on the oven bottom.

CAUTION

Do not add ammonia, oven cleaners, or any other household cleaners or chemicals to the water used in the steam clean cycle.

CAUTION

Before manually cleaning any part of the range, be sure all controls are turned off and the range is cool. The range may be hot and can cause burns.

To set a steam clean cycle:

1. Oven should be at room temperature. Remove all racks and oven accessories.
2. Scrape or wipe loose debris from the oven bottom.
3. Pour 8 oz (235 ml) distilled or filtered water onto the oven bottom. Close the oven door.

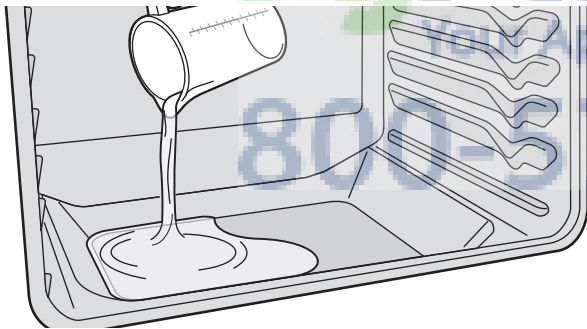

Fig. 14 Adding water for steam clean feature

4. Press **steam clean**. **StC** will show in the display.
5. Press **start**.



Figure 15: Display showing active steam clean

6. If the door is not completely closed a door open message (**d-O**) will appear and the steam clean will not start until the door is fully closed. The door should remain closed during the steam clean operation.

7. Steam clean is a 20 minute cycle. Remaining time will show in the display. An alert tone will sound at the end of the steam clean cycle. Press **off** to return display to the clock.
8. When the steam clean cycle is over, stand to the side of the door to avoid any steam escaping the oven. The cycle includes a cool down period allowing you to immediately use a soft cloth or sponge to remove any remaining water. Wipe oven cavity bottom. Do not clean the oven door gasket (Figure 16).

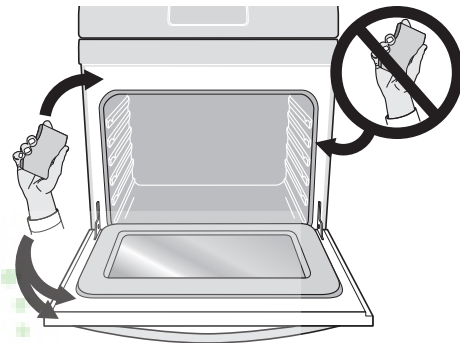

Figure 16: Areas to clean and area (gasket) to avoid

To turn **steam clean** off at any time, press **off**.

Important:

- For best results, clean oven immediately after cycle is complete.
- Steam clean works best for soils on oven bottom. For removal of baked on soils oven may require a deeper cleaning. See Self Cleaning Operation (page 24).
- It is normal if some water vapor or condensation appears close to the oven vent. Wipe with soft cloth or sponge when steam clean cycle is complete.
- The oven gasket may become damp. Do not wipe dry. Open door and allow gasket to air dry.
- Steam clean cannot be programmed with a Delay Start.
- If the door is opened during the steam clean cycle, a beep will sound and **d-O** will appear in the display. Keep oven door closed during the Steam Clean cycle.
- Local water sources can contain minerals (hard water) and will leave deposits on the oven cavity. If this occurs, wipe cavity with vinegar or lemon juice.
- For best results use only distilled or filtered water in a Steam Clean cycle.

OVEN CONTROLS

Self Cleaning Operation

A self cleaning oven cleans itself with high temperatures (well above normal cooking temperatures) which eliminate soils completely or reduces them to a fine powdered ash you can wipe away with a damp cloth.

What to expect during cleaning:

While the oven is in operation sounds of metal expansion and contraction are normal. Odor is also normal as the food soil is being removed. Smoke may appear through the oven vent. If heavy spills are not wiped up before cleaning, they may flame and cause more smoke and odor than usual. This is normal and safe and should not cause alarm. If available, use an exhaust fan during the self cleaning cycle.

CAUTION

When opening the oven after self clean cycle stand to side to allow heat to escape and avoid possible burns.

In self clean the outside of the range can be very hot. Do not leave small children unattended near the oven.

Some birds are extremely sensitive to fumes given off by the self clean cycle. Move birds to a well ventilated room.

Do not line the oven walls, racks, bottom or any part of the range with aluminum foil. This ruins heat distribution, produces poor baking results, and causes permanent damage to the oven interior.

Do not force the oven door open. This can damage the automatic door locking system. Wait until the self clean cycle is finished and the door fully unlocks.

IMPORTANT

- Do not use oven cleaners or oven protective coatings in or around any part of the oven interior.
- Do not clean the oven door gasket. The woven material of the oven door gasket is essential for a good seal. Be careful not to rub, damage or remove the gasket. Do not use any cleaning materials on the oven door gasket. Doing so could cause damage.
- Completely remove all oven racks and any accessories including the broiler pan and insert and any aluminum foil. These items cannot withstand high cleaning temperatures and will melt. If the oven racks are not removed, they will lose their special coating properties and will no longer slide in and out of the oven cavity effortlessly.
- Remove any excessive spills in the oven cavity before starting the Self Cleaning cycle. To clean, use hot, soapy water and a cloth. Large spills can cause heavy smoke or fire when subjected to high temperatures. Do not allow food spills with a high sugar or acid content (such as milk, tomatoes, sauerkraut, fruit juices or pie filling) to remain on the surface as they may leave a dull spot even after cleaning.
- Clean any soil from the oven frame, the door liner outside the oven door gasket and the small area at the front center of the oven bottom. These areas heat sufficiently to burn soil on. Clean with soap and water.

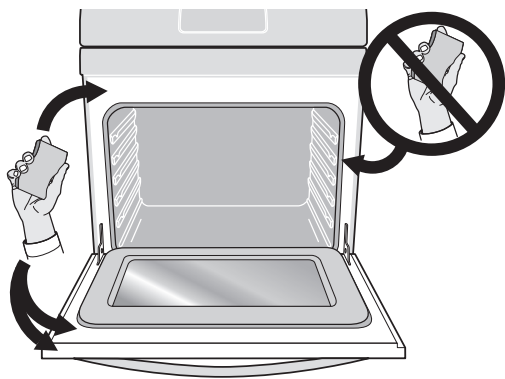



Figure 17: Areas to hand clean and areas to avoid

Setting Self Clean Cycle Duration

The **self clean** key controls the self cleaning feature. If you are planning to use the oven directly after a self clean cycle remember to allow time for the oven to cool down and the oven door to unlock. This normally takes about one hour. So a 3 hour self clean cycle will actually take about 4 hours to complete.

It is recommend to use a 2 hour self clean cycle for light soils, a 3 hour cycle for average soils, and a 4 hour cycle for heavy soils (to assure satisfactory results).

To set the controls for a 3 hour self cleaning cycle to start immediately and shut off automatically:

1. Be sure the clock is set with the correct time of day and the oven door is closed.
2. Press **self clean**. **CLn** and **3:00 HR** will show in the display. The control will automatically clean for a 3 hour period (default self cleaning cycle time). If a 2 or 4 hour clean time is desired, press **self clean** multiple times to toggle between 2, 3 or 4 hours.
3. Press **start**. A beep will sound and the **DOOR** and  icon will flash; **CLn** will remain on in the display.
4. As soon as the control is set, the motor driven oven door lock will begin to close automatically. Once the door has been locked the **DOOR** indicator light and icon  will remain on. Also, the oven icon will appear in the display. Allow about 15 seconds for the oven door to lock completely.

When the Self Clean cycle is completed:

1. **HOT** will appear in the display. The time of day, the **DOOR** and  icon will remain in the display.
2. Once the oven has cooled for approximately 1 HOUR, the **DOOR** icon will flash until the door unlocks, The door can be opened and timer will revert back to the time of the day.



Stopping a Self Clean Cycle

If it becomes necessary to stop or interrupt a self cleaning cycle due to excessive smoke or fire in the oven:

1. Press **off**.
2. The oven door can only be opened after the oven has cooled down and the **DOOR** icon will flash until the door is unlocked, the oven door can then be opened and the timer will revert back to the time of the day.

The **self clean** and **delay start** keys control the Delayed Self Clean operation. The automatic timer will turn the oven on and off at the time you select in advance.

To set the control for the self cleaning cycle to start at a delayed time and shut off automatically (example: 3 hour self clean cycle to start at 4:30):

1. Be sure the clock is set with the correct time of day and the oven door is closed.
2. Press **self clean**. **CLn** and **3:00 HR** will show in the display. The control will be set for a 3 hour clean period. If a 2 or 4 hour clean time is desired, press **self clean** multiple times to toggle between 2, 3 or 4 hours.
3. Press **start**. A beep will sound and the **DOOR** and  lock icon will flash; the letters **CLn** will remain on in the display.
4. Press **delay start**. Enter the desired start time using the number keys **4 3 0**.
5. Press **start**.
6. **delay**, **DOOR** and  icons will remain on.
7. As soon as the control is set, the motor driven oven door lock will begin to close automatically. Once the door has been locked the **DOOR** and  indicator light will remain on.
8. The control will start the self cleaning at the set start time, for the period of time previously selected. At that time, the **delay** message will go out; **CLn** and oven icon will appear in the display.

When the self clean cycle is completed:

1. **HOT** will appear in the display. The time of day, the **DOOR** and  icon will remain in the display.
2. When oven cools approximately 1 HOUR, the **DOOR** icon will flash until the door is unlocked, the oven door can then be opened and the timer will revert back to the time of the day.

CARE AND CLEANING

Cleaning Various Parts of Your Wall Oven

Before cleaning any part of the oven, be sure all controls are turned off and the oven is cool. Remove spills and any heavy soiling as soon as possible. Regular cleaning will reduce the number of major cleaning later.

Surface Type	Recommendation
Aluminum and Vinyl	Use hot, soapy water and a cloth. Dry with a clean cloth.
Painted and plastic control knobs Painted body parts Painted decorative trims	Using a soft cloth and clean with mild dish detergent and water or a 50/50 solution of vinegar and water. Follow by rinsing the area with clean water; dry and polish with a soft cloth. Glass cleaners may be used if sprayed on a soft cloth first. Do not spray liquids directly on the oven control and display area. Do not use large amounts of water on the control panel - excess water on the control area may cause damage to the appliance. Do not use other liquid cleaners, abrasive cleaners, scouring pads, or paper towels - they will damage the finish. To remove control knobs, turn to the OFF position; grasp firmly and pull straight off the shaft. To replace knobs after cleaning, line up the flat sides of both the knob and the shaft; then push the knob into place.
Stainless Steel	Your oven finish may be made with stainless steel (some models). Clean the stainless with warm soapy water using a clean sponge or cloth. Rinse with clean water and dry with a soft clean cloth. Do not use any store bought cleaners like stainless steel cleaners or any other types of cleaners containing any abrasive, chlorides, chlorine or ammonia. It is recommended to use mild dish soap and water or a 50/50 solution of water and vinegar.
Porcelain enamel broiler pan and insert (available by mail order) Door liner and body parts	Gentle scouring with a soapy scouring pad will remove most spots. Rinse with a 1:1 solution of clear water and ammonia. If necessary, cover difficult spots with an ammonia-soaked paper towel for 30 to 40 minutes. Rinse with clean water and a damp cloth, and then scrub with a soap-filled scouring pad. Rinse and wipe dry with a clean cloth. Remove all cleaners or the porcelain may become damaged during future heating.
Oven racks	Oven racks must be removed from oven cavity. Clean by using a mild, abrasive cleaner following manufacturer's instructions. Rinse with clean water and dry.
Oven door	Use soap and water to thoroughly clean the top, sides, and front of the oven door. Rinse well. You may use a glass cleaner on the outside glass of the door. Do not immerse the door in water. Do not spray or allow water or the glass cleaner to enter the door vents. Do not use oven cleaners, cleaning powders, or any harsh abrasive cleaning materials on the outside of the oven door. Do not clean the oven door gasket. On self-clean models, the oven door gasket is made of a woven material which is essential for a good seal. Care should be taken not to rub, damage, or remove this gasket.

Removing and Replacing the Oven Door

⚠ CAUTION

The door is heavy. For safe, temporary storage, lay the door flat with the inside of the door facing down.

➔ IMPORTANT

Special door care instructions - Most oven doors contain glass that can break. Do not close the oven door until all the oven racks are fully in place. Do not hit the glass with pots, pans, or any other object. Scratching, hitting, jarring, or stressing the glass may weaken its structure causing an increased risk of breakage at a later time.

To remove oven door:

1. Open oven door completely, horizontal with floor (See [Figure 18](#)).
2. Pull the door hinge locks on both left and right door hinges down from the oven frame completely towards the oven door (See [Figure 19](#)). A tool such as a small flat-blade screwdriver may be required.
3. Firmly grasp both sides of oven door along the door sides. Do not use the oven door handle (See [Figure 20](#)).
4. Close the door to the broil stop position (the oven door will stop into this position just before fully closing).
5. Lift the oven door hinge arms over the roller pins located on each side of the oven frame (See [Figure 20](#)).

To replace oven door:

1. Firmly grasp both sides of oven door along the door sides. Do not use the oven door handle (See [Figure 20](#)).
2. Holding the oven door at the same angle as the removal position, seat the hook of the hinge arm over the roller pins located on each side of the oven door frame (See [Figure 20](#) and [Figure 21](#)). The hook of the hinge arms must be fully seated onto the roller pins.
3. Fully open the oven door, horizontal with floor See [Figure 18](#)).
4. Push the door hinge locks up towards and into the oven frame on both left and right oven door hinges to the locked position (See [Figure 19](#)).
5. Close the oven door.

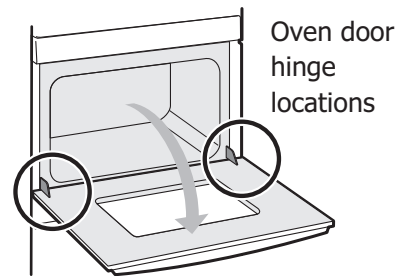

Figure 18: Door hinge location

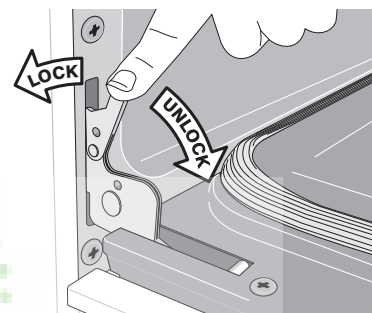

Figure 19: Door hinge locks



Figure 20: Holding door for removal

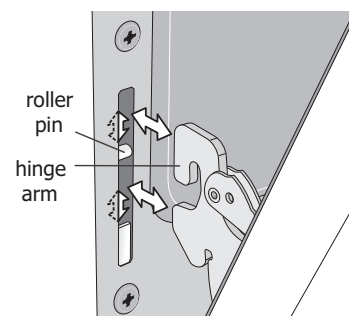

Figure 21: Replacement and location of hinge arm and roller pin

CARE AND CLEANING

Replacing the Oven Light

CAUTION

Be sure the oven is unplugged and all parts are cool before replacing oven light.

The interior oven lights are located at the rear of the oven cavity and are covered with a glass shield. The glass shield must be in place whenever the oven is in use (See [Figure 22](#)).

Replacing the oven interior light bulb:

1. Turn electrical power off at the main source or unplug the appliance.
2. Remove interior oven light shield by turning a quarter turn.
3. Replace bulb with a new T-4 type Halogen 25 watt appliance bulb.

NOTE

Do not allow your fingers to touch the new bulb when replacing. This will shorten the life of the bulb. Use a paper towel or cotton glove while handling the new bulb when installing.

4. Replace glass oven light shield.
5. Turn power back on again at the main source (or plug the appliance back in).
6. Be sure to reset the time of day on the clock.

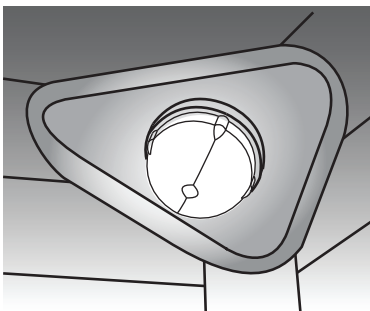







Figure 22: Wall oven Halogen light

Solutions to Common Baking Problems

For best cooking results, heat the oven before baking cookies, breads, cakes, pies or pastries, etc. There is no need to preheat the oven for roasting meat or baking casseroles.

The cooking times and temperatures needed to bake a product may vary slightly from your previously owned appliance.

Baking Problems and Solutions Chart

Baking Problems	Causes	Corrections
<p>Cookies and biscuits burn on the bottom.</p> 	<ul style="list-style-type: none"> • Cookies and biscuits put into oven before the preheating time is completed. • Oven rack is overcrowded. • Dark pans absorb heat too fast. 	<ul style="list-style-type: none"> • Allow oven to preheat to desired temperature before placing food in oven. • Choose pan sizes that will permit 2" to 4" of air space (5.1 cm to 10.2 cm) on all sides when placed in the oven. • Use a medium weight baking sheet.
<p>Cakes too dark on top or bottom.</p> 	<ul style="list-style-type: none"> • Cakes put in oven before preheating time is completed. • Rack position too high or too low. • Oven too hot. 	<ul style="list-style-type: none"> • Allow oven to preheat to the selected temperature before placing food in the oven. • Use proper rack position for baking needs. • Set oven temperature 25°F/12°C lower than recommended.
<p>Cakes not done in center.</p> 	<ul style="list-style-type: none"> • Oven too hot. • Incorrect pan size. • Pan not centered in oven. 	<ul style="list-style-type: none"> • Set oven temperature 25°F/12°C lower than recommended. • Use pan size suggested in recipe. • Use proper rack position and place pan to allow for 5.1 cm to 10.2 cm (2" to 4") of space on all sides of pan.
<p>Cakes not level.</p> 	<ul style="list-style-type: none"> • Range not level. • Pan too close to oven wall or rack overcrowded. • Pan warped. 	<ul style="list-style-type: none"> • Place a marked glass measuring cup filled with water on the center of the oven rack. If the water level is uneven, refer to the installation instructions for leveling the range. • Be sure to allow 5.1 cm to 10.2 cm (2" to 4") of clearance on all sides of each pan in the oven. • Do not use pans that are dented or warped.
<p>Foods not done when cooking time is over.</p> 	<ul style="list-style-type: none"> • Oven too cool. • Oven overcrowded. • Oven door opened too frequently. 	<ul style="list-style-type: none"> • Set oven temperature 25°F/12°C higher than suggested and bake for the recommended time. • Be sure to remove all pans from the oven except the ones to be used for baking. • Open oven door only after shortest recommended baking time.

BEFORE YOU CALL

Solutions to Common Problems

Before you call for service, review the following list. It may save you time and expense. Possible solutions are provided with the problem listed:

Problem	Solution
Poor baking results	Many factors effect baking results. Use proper oven rack position. Center food in the oven and space pans to allow air to circulate. Preheat oven to the set temperature before placing food in the oven. Try adjusting the recipe's recommended temperature or baking time. See "Adjusting oven temperatures" on page 23 if you feel the oven is too hot or cold.
Appliance is not level	Be sure floor is level, strong and stable enough to adequately support range. If floor is sagging or sloping, contact a carpenter to correct the situation. Poor installation. Place oven rack in center of oven and place a level on the oven rack. Adjust leveling legs at base of appliance until the rack is level. Kitchen cabinet alignment may make range appear not level. Be sure cabinets are square and have sufficient room for appliance clearance.
Cannot move appliance easily. Appliance must be accessible for service.	Cabinets not square or are built in too tight to allow clearance for appliance. Contact builder or installer to make appliance accessible. Carpet interferes with appliance. Provide sufficient space so appliance can be lifted over carpet.
Entire appliance does not work.	For models with a power cord, make sure power cord is plugged properly into outlet. If electricity to home is working, check fuse box or breaker. Call your local electric company for service outage information. Service wiring is not complete. Call 1-800-4-MY-HOME® for assistance.
Oven portion does not operate.	The time of day is not set. The oven clock must first be set in order to operate the oven. See "Setting the Clock" on ^a Be sure oven controls are set properly. See "Oven Control Functions" on page 14 and review instructions for the desired cooking function in this manual or see "Entire appliance does not operate" in this checklist.
Oven light does not work.	Be sure the oven light is secure in the socket. See "Replacing the Oven Light" on page 28
Cooking zones do not glow when heating.	Induction cooking zones will not glow when in use. Induction cooking uses electromagnetic energy to induce heat directly to the cookware.
Flames inside oven or smoking from oven vent.	Excessive spills in oven. Grease or food spilled onto oven bottom or oven cavity. Wipe up excessive spills before starting oven. If flames or excessive smoke are present when using Broil, see "Setting Broil" page 13 .
Self Clean does not work.	Oven control not set properly. Review instructions in Self Clean section.
Oven racks discolored or do not slide easily.	Oven racks left in oven cavity during Self Clean. Always remove oven racks from oven cavity before starting a self-clean cycle. Clean by using a mild abrasive cleaner following manufacturer's instructions. Rinse with clean water, dry, and replace in oven.

BEFORE YOU CALL

Oven smokes excessively when broiling.	<p>Incorrect setting. Follow broiling instructions in Setting Oven Controls section.</p> <p>Meat too close to the broil element. Reposition broil rack to provide proper clearance between the meat and broil element. Remove excess fat from meat. Cut remaining fatty edges to prevent curling, but do not cut into lean.</p> <p>Grease build up on oven surfaces. Regular cleaning is necessary when broiling frequently. Grease or food splatters will cause excessive smoking.</p>
Oven control panel beeps and displays any F or E code error.	<p>Oven control has detected a fault or error condition. Press Clear off key to clear the error code. Try Bake or Broil function. If the F or E code error repeats, turn OFF power to appliance, wait 5 minutes and then repower appliance. Set clock with correct time of day. Try Bake or Broil function again. If fault recurs, press Clear off to clear and call 1-800-4-MY-HOME® for assistance.</p>
Soil not completely removed after Self Clean.	<p>Self Clean was interrupted. Review instructions in Self Clean section.</p> <p>Excessive spills on oven bottom. Clean before starting Self Clean.</p> <p>Failure to clean soil from the oven frame, the door liner outside the oven door gasket and the small area at the front center of the oven bottom. These areas are not in the self-cleaning area, but get hot enough to burn on residue. Clean these areas before starting the self-cleaning cycle. Burned-on residue can be cleaned with a stiff nylon brush and water or a nylon scrubber. Be careful not to damage the oven gasket.</p>
Convection fan does not rotate.	<p>Oven door is open. Convection fan will turn off if oven door is opened when Convection is active. Close oven door.</p>
Oven racks discolored or do not slide easily.	<p>Oven racks left in oven cavity during Self Clean. Always remove oven racks from oven cavity before starting a self-clean cycle. Clean by using a mild abrasive cleaner following manufacturer's instructions. Rinse with clean water, dry, and replace in oven.</p>
Self Clean does not work.	<p>Oven control not set properly. Review instructions in Self Clean section.</p>

800-570-3355

WARRANTY

Your appliance is covered by a one year limited warranty. For one year from your original date of purchase, Electrolux will pay all costs for repairing or replacing any parts of this appliance that prove to be defective in materials or workmanship when such appliance is installed, used and maintained in accordance with the provided instructions.

Exclusions

This warranty does not cover the following:

1. Products with original serial numbers that have been removed, altered or cannot be readily determined.
2. Product that has been transferred from its original owner to another party or removed outside the USA or Canada.
3. Rust on the interior or exterior of the unit.
4. Products purchased "as-is" are not covered by this warranty.
5. Food loss due to any refrigerator or freezer failures.
6. Products used in a commercial setting.
7. Service calls which do not involve malfunction or defects in materials or workmanship, or for appliances not in ordinary household use or used other than in accordance with the provided instructions.
8. Service calls to correct the installation of your appliance or to instruct you how to use your appliance.
9. Expenses for making the appliance accessible for servicing, such as removal of trim, cupboards, shelves, etc., which are not a part of the appliance when it is shipped from the factory.
10. Service calls to repair or replace appliance light bulbs, air filters, water filters, other consumables, or knobs, handles, or other cosmetic parts.
11. Surcharges including, but not limited to, any after hour, weekend, or holiday service calls, tolls, ferry trip charges, or mileage expense for service calls to remote areas, including the state of Alaska.
12. Damages to the finish of appliance or home incurred during installation, including but not limited to floors, cabinets, walls, etc.
13. Damages caused by: services performed by unauthorized service companies; use of parts other than genuine Electrolux parts or parts obtained from persons other than authorized service companies; or external causes such as abuse, misuse, inadequate power supply, accidents, fires, or acts of God.

DISCLAIMER OF IMPLIED WARRANTIES; LIMITATION OF REMEDIES

CUSTOMER'S SOLE AND EXCLUSIVE REMEDY UNDER THIS LIMITED WARRANTY SHALL BE PRODUCT REPAIR OR REPLACEMENT AS PROVIDED HEREIN. CLAIMS BASED ON IMPLIED WARRANTIES, INCLUDING WARRANTIES OF MERCHANTABILITY OR FITNESS FOR A PARTICULAR PURPOSE, ARE LIMITED TO ONE YEAR OR THE SHORTEST PERIOD ALLOWED BY LAW, BUT NOT LESS THAN ONE YEAR. ELECTROLUX SHALL NOT BE LIABLE FOR CONSEQUENTIAL OR INCIDENTAL DAMAGES SUCH AS PROPERTY DAMAGE AND INCIDENTAL EXPENSES RESULTING FROM ANY BREACH OF THIS WRITTEN LIMITED WARRANTY OR ANY IMPLIED WARRANTY. SOME STATES AND PROVINCES DO NOT ALLOW THE EXCLUSION OR LIMITATION OF INCIDENTAL OR CONSEQUENTIAL DAMAGES, OR LIMITATIONS ON THE DURATION OF IMPLIED WARRANTIES, SO THESE LIMITATIONS OR EXCLUSIONS MAY NOT APPLY TO YOU. THIS WRITTEN WARRANTY GIVES YOU SPECIFIC LEGAL RIGHTS. YOU MAY ALSO HAVE OTHER RIGHTS THAT VARY FROM STATE TO STATE.

If You Need Service

Keep your receipt, delivery slip, or some other appropriate payment record to establish the warranty period should service be required. If service is performed, it is in your best interest to obtain and keep all receipts. Service under this warranty must be obtained by contacting Electrolux at the addresses or phone numbers below.

This warranty only applies in the USA and Canada. In the USA, your appliance is warranted by Electrolux Major Appliances North America, a division of Electrolux Home Products, Inc. In Canada, your appliance is warranted by Electrolux Canada Corp. Electrolux authorizes no person to change or add to any obligations under this warranty. Obligations for service and parts under this warranty must be performed by Electrolux or an authorized service company. Product features or specifications as described or illustrated are subject to change without notice.

USA
1.800.944.9044
Electrolux Home Products, Inc.
10200 David Taylor Drive
Charlotte, NC 28262



Canada
1.800.265.8352
Electrolux Canada Corp.
5855 Terry Fox Way
Mississauga, Ontario, Canada
L5V 3E4