

SERVICE DATA SHEET

Electric Ranges with ES 330/330i Electronic Oven Controls

NOTICE - This service data sheet is intended for use by persons having electrical and mechanical training and a level of knowledge of these subjects generally considered acceptable in the appliance repair trade. The manufacturer cannot be responsible, nor assume any liability for injury or damage of any kind arising from the use of this data sheet.

SAFESERVICINGPRACTICES

To avoid the possibility of personal injury and/or property damage, it is important that safe servicing practices be observed. The following are examples, but without limitation, of such practices.

1. Before servicing or moving an appliance remove power cord from electrical outlet, trip circuit breaker to OFF, or remove fuse.
2. Never interfere with the proper installation of any safety device.
3. **GROUNDING:** The standard color coding for safety ground wires is GREEN or GREEN WITH YELLOW STRIPES. Ground leads are not to be used as current carrying conductors. It is extremely important that the service technician reestablish all safety grounds prior to completion of service. Failure to do so will create a potential safety hazard.

COOKTOP LOCKOUT PCB (some models)

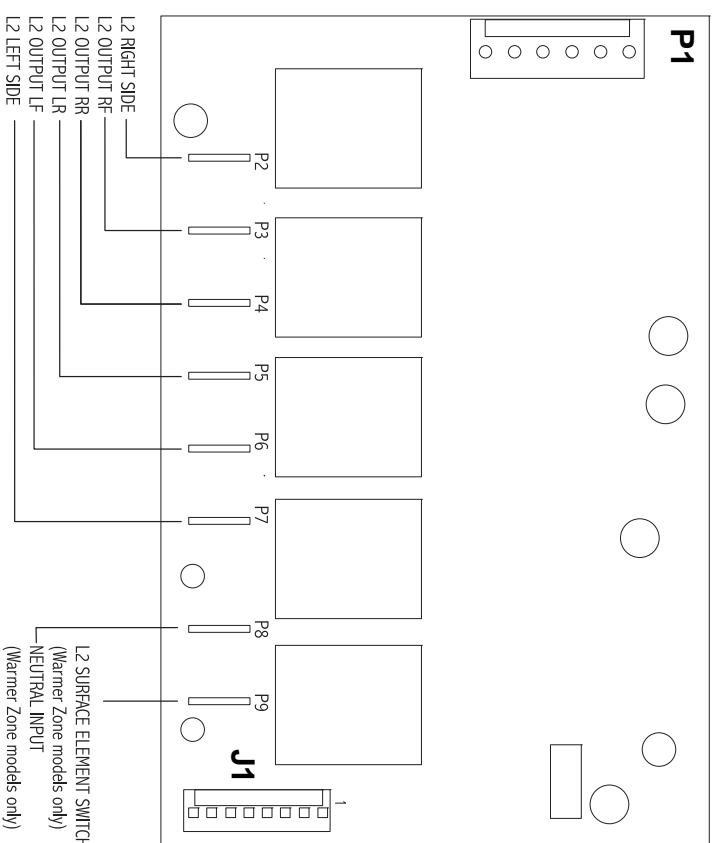

4. Prior to returning the product to service, ensure that:
 - All electrical connections are correct and secure.
 - All electrical leads are properly dressed and secured away from sharp edges, high-temperature components, and moving parts.
 - All uninsulated electrical terminals, connectors, heaters, etc. are adequately spaced away from all metal parts and panels.
 - All safety grounds (both internal and external) are correctly and securely reassembled.

OVEN CALIBRATION

Set the electronic oven control for normal baking at 350°F. Obtain an average oven temperature after a minimum of 5 cycles. Press **Cancel** to end bake mode.

TEMPERATURE ADJUSTMENT

1. Set EOC to bake at 550°F.
2. Within 5 seconds of setting 550°F, press and hold the bake pad for approximately 15 seconds until a single beep is heard (longer may cause F11 shorted keypad alarm).
3. Calibration offset should appear in the display.
4. Use the slew keys to adjust the oven temperature up or down 35°F in 5°F increments.
5. Once the desired (-35° to 35°) offset has been applied, press **Cancel**.

Note: Changing calibration affects normal Bake mode. The adjustments made will not change the Self-Cleaning cycle temperature.

SIMMER SELECT PCB (some models)

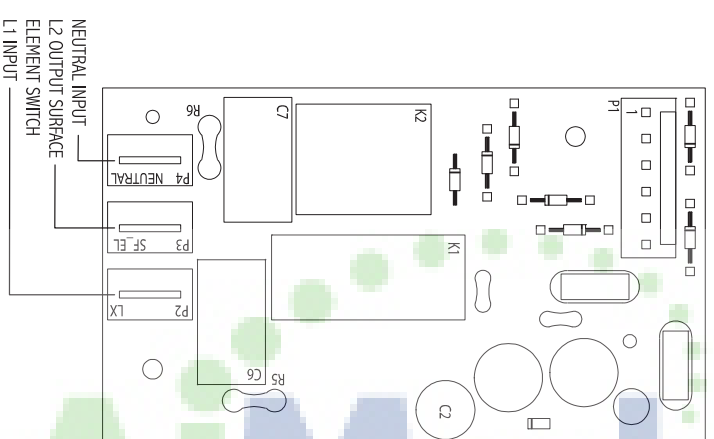

IMPORTANT
DO NOT REMOVE THIS BAG
OR DESTROY THE CONTENTS
WIRING DIAGRAMS AND SERVICE
INFORMATION ENCLOSED
REPLACE CONTENTS IN BAG

**RESISTANCE
TEMPERATURE
DETECTORS**

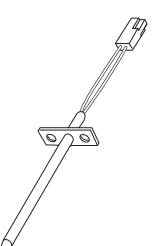

RTD SCALE	
Temperature (°F)	Resistance (ohms)
32 ± 1.9	1000 ± 4.0
75 ± 2.5	1091 ± 5.3
250 ± 4.4	1453 ± 8.9
350 ± 5.4	1654 ± 10.8
450 ± 6.9	1852 ± 13.5
550 ± 8.2	2047 ± 15.8
650 ± 9.6	2237 ± 18.5
900 ± 13.6	2697 ± 24.4

ELECTRONIC OVEN CONTROL (REAR VIEW)

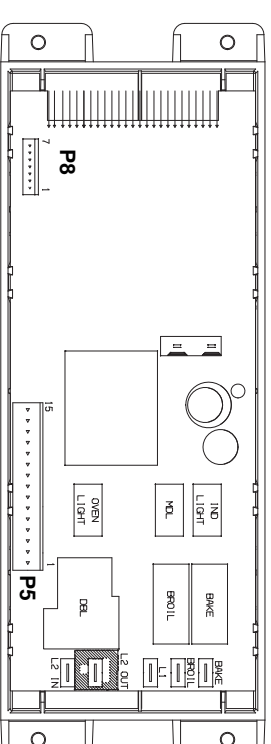

E.O.C. ELECTRICAL CONNECTIONS

P5 Connections

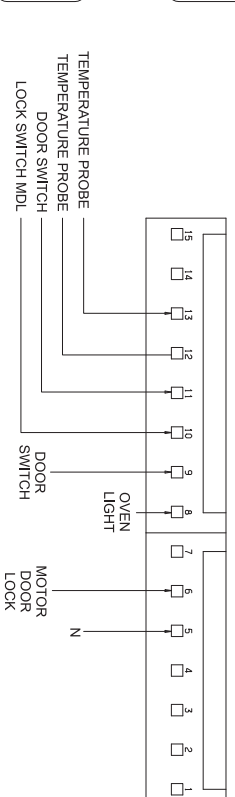

P8 Cooktop Lockout Connections (some models)

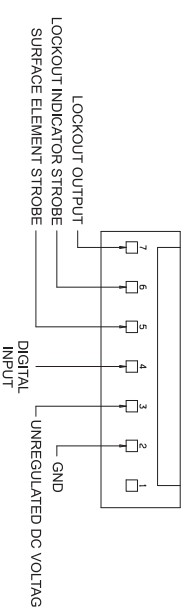

ELECTRONIC OVEN CONTROL FAULT CODE DESCRIPTIONS

Fault Code	Likely Failure Condition/Cause	Suggested Corrective Action
F10	Runaway Temperature.	1. (F10 only) Check RTD Sensor Probe & replace if necessary. If oven is overheating, disconnect power. If oven continues to overheat when the power is reappplied, replace EOC. Severe overheating may require the entire oven to be replaced should damage be extensive.
F11	Shorted Keypad.	2. (F11, 12 & 13) Disconnect power, wait 30 seconds and reapply power.
F12	Bad Micro Identification.	3. (F11, 12 & 13) If fault returns upon power-up, replace EOC.
F13	Bad EEPROM Identification/Checksum error.	
F30	Open probe connection.	1. (F30 or F31) Check resistance at room temperature & compare to RTD Sensor resistance chart. If resistance does not match the RTD chart replace RTD Sensor Probe. Check Sensor wiring harness between EOC & Sensor Probe connector.
F31	Shorted Probe connection.	2. (F30 or F31) Check resistance at room temperature, if less than 500 ohms, replace RTD Sensor Probe. Check for shorted Sensor Probe harness between EOC & Probe connector.
F40	Cooktop Lockout error (some models).	1. (F40) Check the wiring. 2. (F40) Replace the Cooktop Lockout Control Board. 3. (F40) Replace EOC.
F90	Maximum oven door unlock time exceeded.	1. (F90, 91, 92, 93 & 94) Check the wiring between EOC & Lock Motor Micro Switch.
F91	Maximum oven door unlock attempts exceeded.	2. (F90, 91, 92, 93 & 94) Replace the Motor Door Latch assembly if necessary.
F92	Maximum oven door open time exceeded.	3. (F90, 91, 92, 93 & 94) Check for binding of the Latch Cam, Lock Motor Rod & Lock Motor Cam Assembly.
F93	Maximum oven door lock time exceeded.	4. (F90, 91, 92, 93 & 94) Check to see if Lock Motor Coil is open. If open, replace Lock Motor Assembly.
F94	Maximum oven door lock attempts exceeded.	5. (F90, 91, 92, 93 & 94) Lock Motor continuously runs - if Micro Switch is open, replace Lock Motor Assembly. 6. (F92, 93 & 94) Check oven door Light Switch - if open, replace Switch. 7. If all situations above do not solve problem, replace EOC.

CIRCUIT ANALYSIS MATRIX

	EOC Relays					Door Switch COM-NO	Warmer Drawer Lock Switch MDL (some models)	Cooktop Lockout (some models)
	L1 to Bake	L1 to Broil	L1 to Motor Door Latch	L1 to Conv/Speed Bake Fan (some models)	L1 to Conv/Speed Bake Ind Light (some models)			
Bake/Time Bake	X	X*					X	
Conv/Speed Bake	X	X*		X	X		X	
Broil		X					X	
Clean	X							
Unlocked							X	
Locking			X				X	
Locked						X		
Unlocking					X		X	
Door Open								
Door Closed						X		
Cooktop Active								X

Note: X=Check listed circuits. *-Alternates with Bake element.

GENERAL TROUBLESHOOTING DIAGRAM

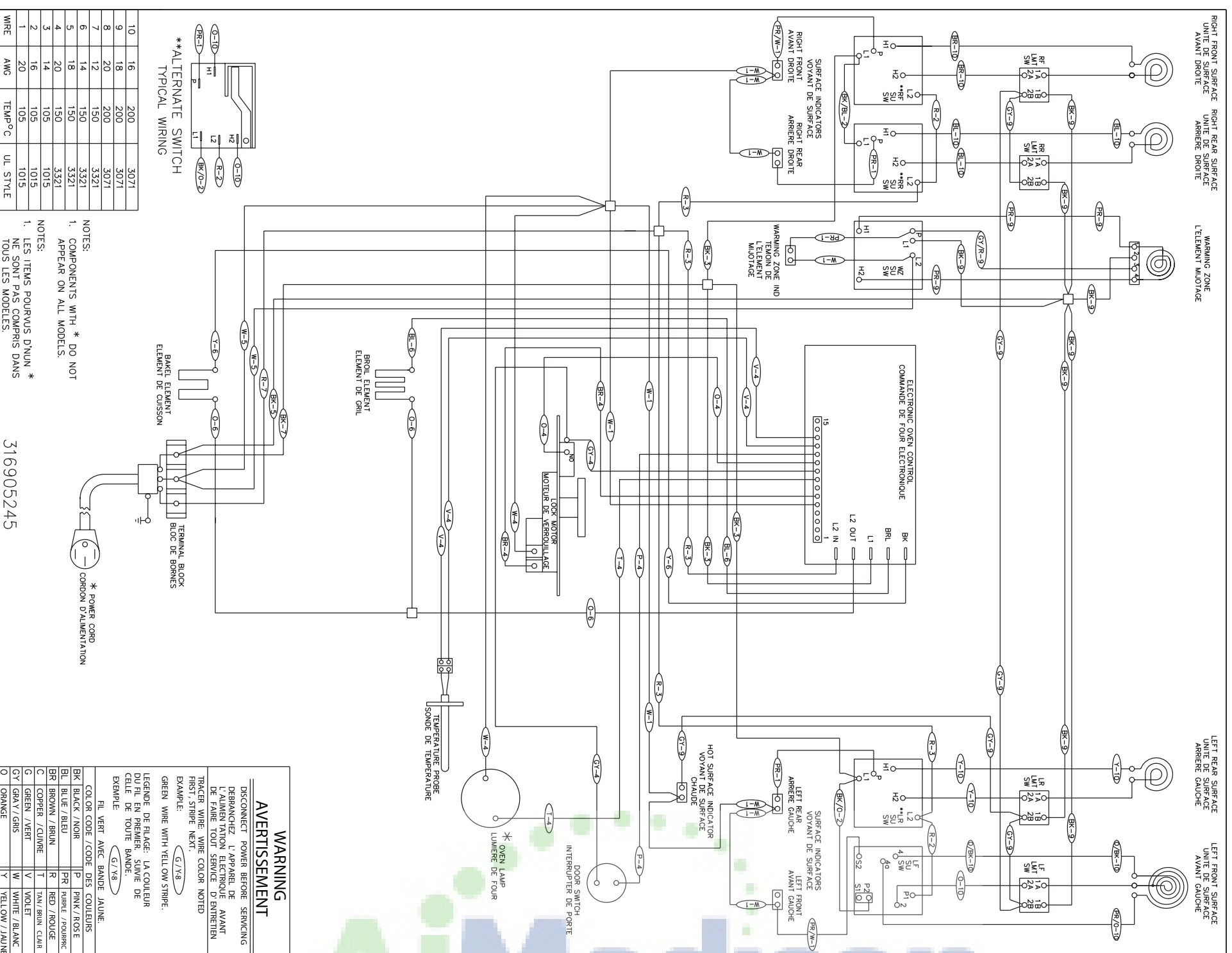

WARNING
AVERTISSEMENT

DISCONNECT POWER BEFORE SERVICING
 DEBRANCHEZ L'APPAREIL DE L'ALIMENTATION ELECTRIQUE AVANT DE FAIRE TOUT SERVICE D'ENTRETIEN

TRACER WIRE: WIRE COLOR NOTED
 PMSI, STRIPE: NEUT.

EXAMPLE: G/Yx8

LEGENDE DE RILAGE: LA COULEUR DU FIL EN PREMIER, SUIVIE DE CELLE DE TOUTE BANDE.

EXEMPLE: FIL VERT AVEC BANDE JAUNE.

COLOR CODE / CODE DES COULEURS	
BR	BLACK / NOIR
BL	BLUE / BLEU
BRN	BROWN / BRUN
C	COPPER / CUIVRE
G	GREEN / VERT
GY	GRAY / GRIS
O	ORANGE
P	PINK / ROSE
PR	SILVER / ARGENT
R	RED / ROUGE
TAN	TAN / BRUN CLAIR
V	VIOLET
W	WHITE / BLANC
Y	YELLOW / JAUNE

GENERAL TROUBLESHOOTING SCHEMATIC

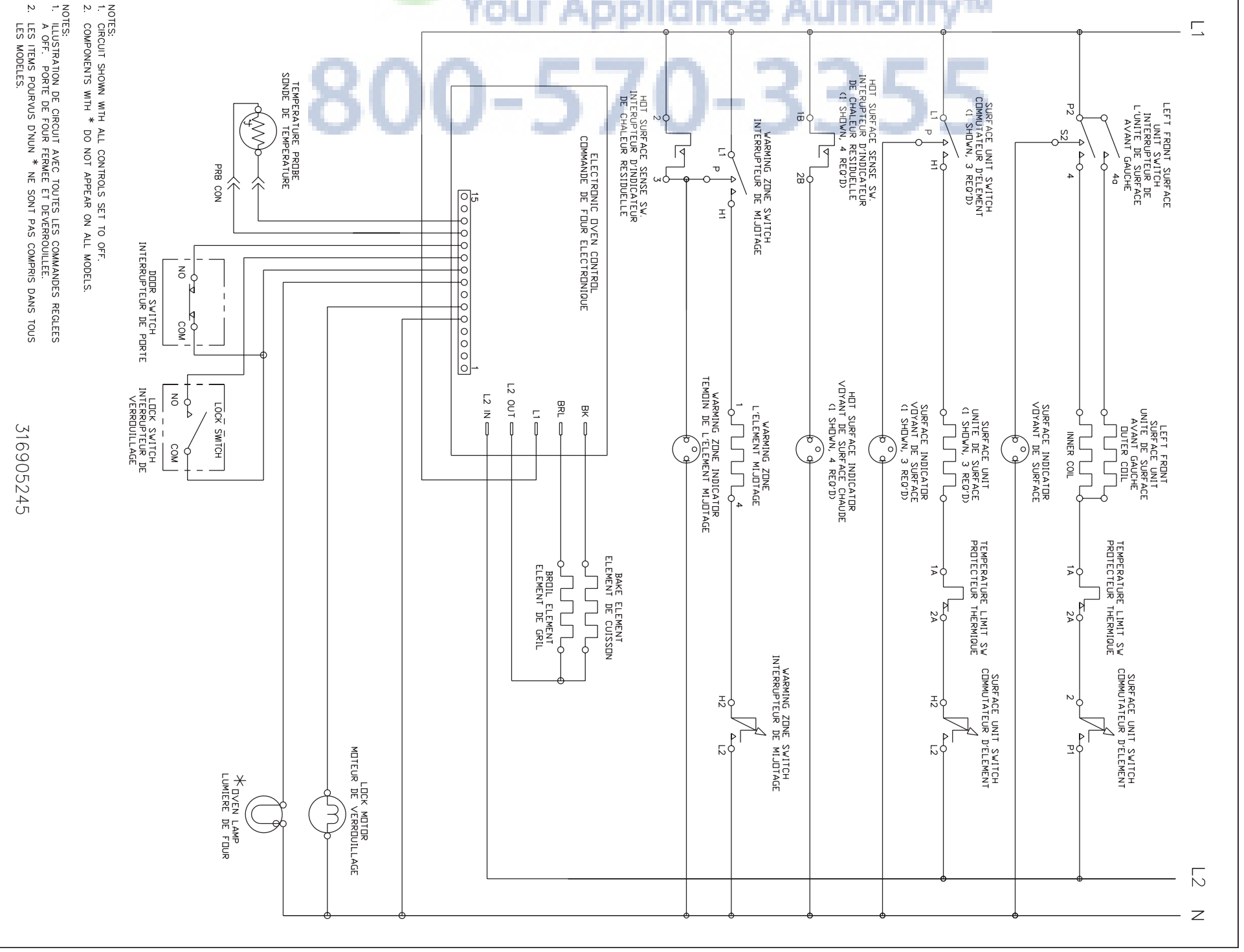

800-570-3355

AjMadison
 Your Appliance Authority™

316905245