



ECHELON

DIAMOND SERIES

OUTDOOR STAND-ALONE GAS GRILL E660s, E790s, and E1060s

INSTALLATION INSTRUCTIONS AND OWNER'S MANUAL

INSTALLER: Leave these instructions with consumer.
CONSUMER: Retain for future reference.



E790s shown

IMPORTANT: READ THESE INSTRUCTIONS CAREFULLY BEFORE STARTING INSTALLATION OR USE.

WARNINGS AND SAFETY CODES

⚠ DANGER:

IF YOU SMELL GAS:

1. Shut off the gas to the appliance.
2. Extinguish any open flame.
3. Open lid.
4. If odor continues, keep away from the appliance and **immediately** call your gas supplier or the fire department.

⚠ WARNING:

1. Do not store or use gasoline or other flammable vapors and liquids in the vicinity of this or any other appliance.
2. An LP cylinder not connected for use shall not be stored in the vicinity of this or any other appliance.

CODE AND SUPPLY REQUIREMENTS: This outdoor gas grill must be installed in accordance with local codes and ordinances, or, in the absence of local codes, with the latest *National Fuel Gas Code (ANSI Z223.1/NFPA 54)*, or *Natural Gas and Propane Storage and Handling Installation Code (CSA-B149.1)*.

This appliance and its dedicated manual shutoff valve must be disconnected from the gas-supply piping system when testing the system at pressures in excess of ½ psig (3.5 kPa).

This appliance must be isolated from the gas-supply piping system by closing its dedicated manual shutoff valve during any pressure testing of the gas-supply system at pressures up to and including ½ psig (3.5 kPa).

⚠ WARNING:

Improper installation, adjustment, alteration, service, or maintenance can cause injury or property damage. For proper installation, refer to the installation instructions. For assistance or additional information, consult a qualified professional installer, service agency, or the gas supplier.

All electrical outlets in the vicinity of the grill must be properly grounded in accordance with local codes, or, in the absence of local codes, with the *National Electrical Code, ANSI/NFPA 70*, or the *Canadian Electrical Code, CSA C22.1*, whichever is applicable.

Keep all electrical-supply cords and fuel-supply hoses away from any heated surface.

Proper operation of your grill requires prompt and periodic maintenance. See the CARE & CLEANING section for details.



Certified to: **ANSI Z21.58a-2008**
CSA 1.6a-2008

- INSTALLATION INSTRUCTIONS ET MANUEL DU PROPRIÉTAIRE -

ECHELON GRIL EXTÉRIEUR DE GAZ DU PORTATIF

IMPORTANT: LISEZ CES INSTRUCTIONS SOIGNEUSEMENT AVANT DE COMMENCER L'INSTALLATION OU L'UTILISATION

SÛRETÉ ET CODES D'AVERTISSEMENT

▲ DANGER:

SI VOUS SENTEZ LE GAZ :

1. Coupez l'admission de gaz de l'appareil.
2. Éteindre toute flamme nue.
3. Ouvrir le couvercle.
4. Si l'odeur persiste, éloignez-vous de l'appareil et appelez immédiatement le fournisseur de gaz ou le service d'incendie.

CONDITIONS DE CODE ET D'APPROVISIONNEMENT:

Ce gril doit être installé selon des codes et des ordonnances locaux, ou, en l'absence des codes locaux, avec l'un ou l'autre le plus défunt *Code national de gaz de carburant* (norme ANSI Z223.1/NFPA 54), et *Stockage de gaz naturel et de propane et manipulation du code d'installation* (CSA-B149.1).

Cet appareil et ses différents robinets d'isolement doivent être démontés du gaz-fournissent le système sifflant en examinant le système aux pressions au-dessus du ½ psig (kPa 3.5).

Cet appareil doit être isolé dans gaz-fournissent le système sifflant par fermeture que ses différents robinets d'isolement manuels pendant tous les essais sous pression du gaz-fournissent le système aux pressions jusques et y compris le ½ psig (kPa 3.5).

- Ce gril est pour utilisation à l'extérieur seulement. Si l'appareil est entreposé à l'intérieur, enlever les bouteilles et les laisser à l'extérieur.
- Ne pas ranger le gril immédiatement après l'avoir utilisé. le laisser refroidir avant de le déplacer ou de la ranger. Le non respect de cette mesure de sécurité pourrait entraîner un incendie causant des dommages à la propriété, des blessures ou la mort.
- Ne pas utiliser cet appareil sous une surface combustible.
- Ne pas utiliser cet appareil sous un auvent. Le non respect de cette mesure de sécurité pourrait entraîner un incendie ou des blessures.
- Dégagement minimal entre les parois latérales et l'arrière de l'appareil et la construction combustible (45.7 cm à partir des parois latérales et 45.7cm à partir de l'arrière).
- Le régulateur de pression de gaz prévu avec cet appareil de cuisson à gaz pour l'extérieur doit être utilisé. Ce régulateur est réglé pour une pression de sortie de 5 pouces de colonne de l'eau pour le gaz naturel, et 10 pouces pour le propane.
- LE RÉGULATEUR INCLUS D'APPAREILS EST ÉVALUÉ POUR LE MAXIMUM DE 1/2 (LIVRES PAR POUCE CARRÉ). SI VOTRE OFFRE DE GAZ EST 1/2 PLUS GRAND QUE (LIVRES PAR POUCE CARRÉ), UN

▲ AVERTISSEMENT:

1. Ne stockez pas ou n'employez pas l'essence ou d'autres vapeurs et liquides inflammables à proximité de ceci ou d'aucun autre appareil.
2. Un cylindre de propane non relié pour l'usage ne sera pas stocké à proximité de ceci ou d'aucun autre appareil.

▲ AVERTISSEMENT:

L'installation inexacte, l'ajustement, le changement, le service, ou l'entretien peuvent causer des dommages ou des dégâts matériels. Référez-vous à ce manuel. Pour l'aide ou l'information additionnelle, consultez un installateur professionnel qualifié, l'agence de service, ou le fournisseur de gaz.

Toutes les sorties électriques à proximité du gril doivent être correctement fondues selon des codes locaux, ou en l'absence de local code, avec le code électrique national, ANSI/NFPA 70, ou le code électrique canadien, CSA C22.1, celui qui est applicable.

Maintenez tout électrique-fournissent des cordes et carburant-fournissent des tuyaux partis de n'importe quelle surface de chauffage.

RÉGULATEUR ADDITIONNEL DOIT ÊTRE INSTALLÉ AVANT LE GRIL. VOIR LA SECTION DE CONDITIONS D'OFFRE DE GAZ POUR LA PRESSION APPROPRIÉE D'OFFRE DE GAZ.

- Ne couvrez jamais la surface entière de cuisine ou de gril de gauffreuses ou de casseroles. La surchauffe se produira et les brûleurs ne seront pas très performants quand la chaleur de combustion est emprisonnée au-dessous de la surface à cuire.
- Ne pulvérisez jamais l'eau sur une unité chaude de gaz, comme ceci peut endommager des composants de porcelaine ou de fer de fonte.
- Une fuite de GPL peut causer un incendie ou une explosion si enflammée entraînant des blessures corporelles graves ou la mort.
- Communiquez avec le fournisseur de GPL pour les réparations ou pour disposer de qules bouteille ou du GPL non utilisé.

Certifié à la norme ANSI : Z21.58a-2008 / CSA 1.6a-2008

INSTALLATEUR : Laissez ces instructions avec le consommateur.
CONSOMMATEUR : Maintenez pour la future référence.

CONTENTS

4	REPLACEMENT COMMON PARTS LIST
6	SINGLE SIDEBURNER UNIQUE PARTS LIST
7	DOUBLE SIDEBURNER UNIQUE PARTS LIST
8	POWER BURNER UNIQUE PARTS LIST
9	ELECTRICAL CONNECTIONS
9	GRILL SAFETY INFORMATION
9	MASTER SWITCH
10	MODEL SPECIFICATIONS TABLE
11	INSTALLATION REQUIREMENTS
12	INSTALLING THE STAND-ALONE UNIT
13	SAFE USE & MAINTENANCE OF PROPANE GAS CYLINDERS
15	INSTALLING THE SIDEBURNER SHELF
16	IDENTIFICATION OF GRILL CONTROLS
17	OPTIONAL POWERHOOD
19	LIGHTING (IGNITION) INSTRUCTIONS
19	SHUTTING OFF THE UNIT
21	DIGITAL THERMOMETER / INTERIOR AND KNOB LIGHTS
23	REMOTE RECEIVER (optional)
25	ROTISSERIE INSTRUCTIONS
26	USING THE FOLDING SHELF
26	PAPER TOWEL HOLDER
26	REMOVING DRAWERS
27	POWER BURNER
28	OPTIONAL INFRARED BURNER OPERATION
29	GRILLING TIPS
30	ACCESSORIES
31	FIRE MAGIC® DRIP TRAY
32	REPLACING HALOGEN BULBS
33	POWER SUPPLY FUSE REPLACEMENT
34	CARE & CLEANING
35	TROUBLESHOOTING
36	CONVERTING THE GAS TYPE
39	BURNER AIR SHUTTER ADJUSTMENT
42	DOUBLE SIDEBURNER
44	WARRANTY

ELECTRICAL SAFETY

To protect against electric shock, do not immerse cord or plugs in water or other liquid;

Unplug from the outlet when not in use and before cleaning. Allow to cool before putting on or taking off parts;

Do not operate any outdoor cooking gas appliance with a damaged cord, plug, or after the appliance malfunctions or has been damaged in any manner. Contact the manufacturer for repair;

Do not let the cord hang over the edge of a table or touch hot surfaces;

Do not use an outdoor cooking gas appliance for purposes other than intended;

When connecting, first connect plug to the outdoor cooking gas appliance then plug appliance into the outlet;

Use only a Ground Fault Interrupter (GFI) protected circuit with this outdoor cooking gas appliance;

Never remove the grounding plug or use with an adapter of 2 prongs.

Use only extension cords with a 3 prong grounding plug, rated for the power of the equipment, and approved for outdoor use with a W-A marking.

REPLACEMENT COMMON PARTS LIST

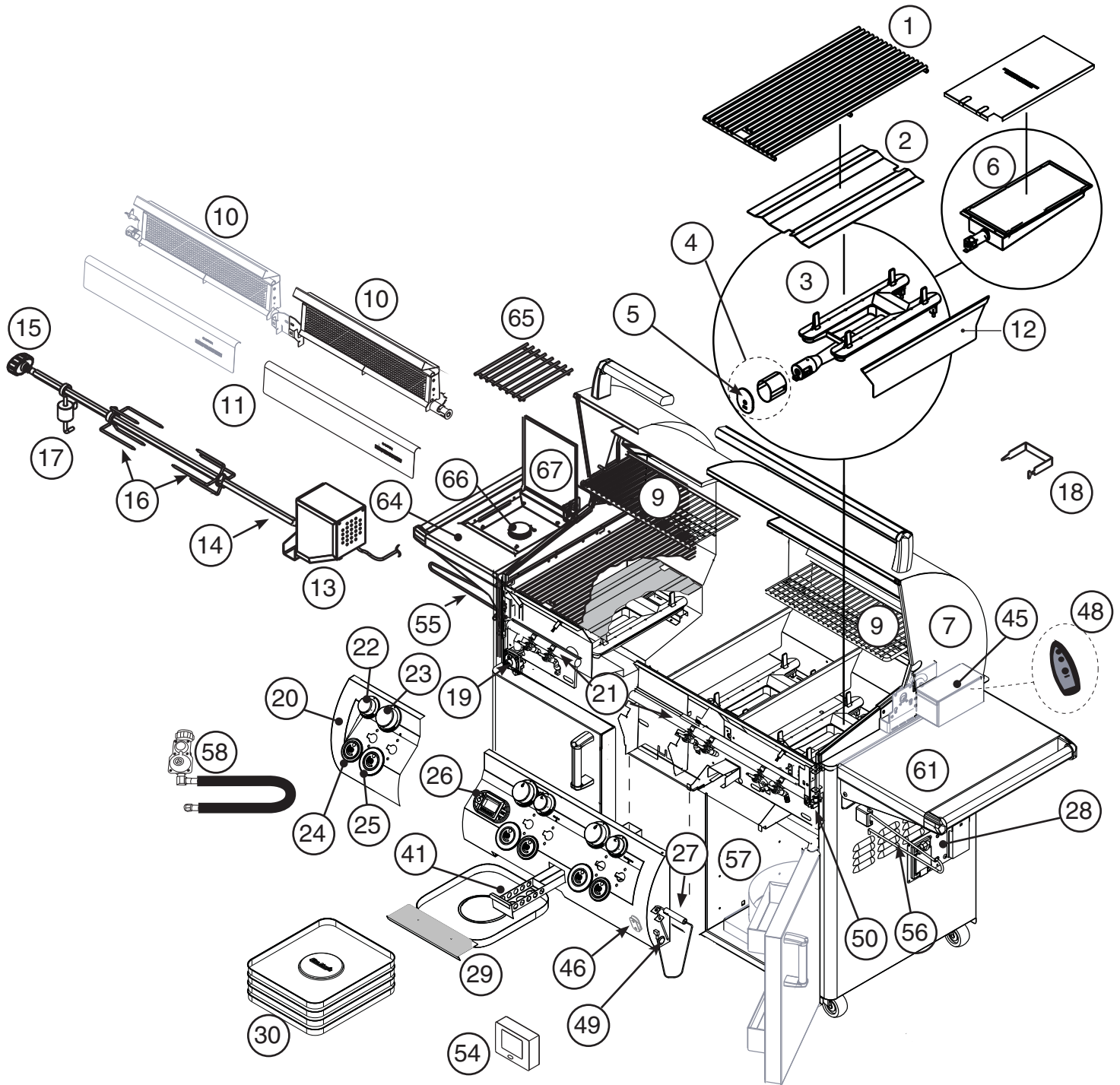

Fig. 4-1

Items in light gray are not available on all models.

To order replacement parts, contact your local Fire-Magic dealer.

E660s & E790s grills are equipped with two drawers on the right side of the unit.

REPLACEMENT COMMON PARTS LIST (cont.)

Item	Description	E660s		E790s		E1060s	
		Part No.	Qty.	Part No.	Qty.	Part No.	Qty.
1.	Stainless cooking grid (set of 3 or 4)	3544-S-3	1	3539-S-3	1	3539-S-2	2
2.	Flavor grid (set of 3 or 4)	3057-S-3	1	3056-S-3	1	3056-S-4	1
3.	Main burner	3041-50	3	3041-50	3	3041-50	4
4.	Heatshield kit	24177-05	3	24177-05	3	24177-05	4
5.	Silicone gasket	24177-06	3	24177-06	3	24177-06	4
6.	Infrared burner (optional)	3050	1	3050	1	3050	1
7.	Oven lid	23738-53	1	23745-53	1	23747-53	1
or	Oven lid w/ window	24193-54	1	24188-54	1	24183-54	1
8.	Window (only)*‡	24187-45	1	24187-45	1	24187-45	1
9.	Warming rack	36735-M	1	36755-M	1	36745-M	1
10.	Back burner	24739-02	1	24745-02	1	24747-02R/L	1
11.	Back burner cover	24739-010	1	24745-010	1	24747-010	2
12.	Zone separator	3061-S	2	3061-S	2	3061-S	3
13.	Heavy-duty rotisserie motor	3600-05M	1	3600-05M	1	3600-05M	1
14.	Heavy-duty rod	3606-40	1	3609-40	1	3607-40	1
15.	Heavy-duty rod knob	24187-16	1	24187-16	1	24187-16	1
16.	Meat holder (pair)	3613	1	3613	1	3613	1
17.	Counterbalance	3620E	1	3620E	1	3620E	1
18.	Grid lifter	3519	1	3519	1	3519	1
19.	Convertible regulator	PR-4	1	PR-4	1	PR-4	1
20.	Control panel w/ back burner †	24393-11	1	24388-11	1	24383-11	1
21.	Valve manifold w/ back burner	24393-22	1	24388-22	1	24383-22	1
22.	Small knob	24182-42	2	24182-42	2	24182-42	3
23.	Large knob	24182-41	3	24182-41	3	24182-41	4
24.	LED disk (small)	24182-44	2	24182-44	2	24182-44	3
25.	LED disk (large)	24182-43	3	24182-43	3	24182-43	4
26.	Digital thermometer	24182-12	1	24182-12	1	24182-12	1
27.	Meat probe	24187-14	1	24187-14	1	24187-14	1
28.	Power supply w/ outlet	24387-18	1	24387-18	1	24387-18	1
29.	Drip tray	3084	1	3084	1	3084	1
30.	Drip tray liner (set of 4)	3557	1	3557	1	3557	1
31.	Wire harness assembly‡	24187-24	1	24187-24	1	24187-24	1
32.	Back burner electrode*‡	4199-52	1	4199-52	1	4199-52	2

* If equipped

‡ Not shown

† Add (M) to part number for powerhood control panel

REPLACEMENT COMMON PARTS LIST (cont.)

Item	Description	E660s		E790s		E1060s	
		Part No.	Qty.	Part No.	Qty.	Part No.	Qty.
33.	Electrode‡	3199-64	3	3199-64	3	3199-64	4
34.	Thermometer wire harness‡	24187-13	1	24187-13	1	24187-13	1
35.	Natural gas orifice(s)‡	3001-42-3	1	3001-38-3	1	3001-40-4	1
36.	Natural back burner gas orifice(s)‡	3001-49-1	1	3001-44-1	1	3001-49-2	1
37.	Propane gas orifice(s)‡	3001-54-3	1	3001-53-3	1	3001-53-4	1
38.	Propane back burner gas orifice(s)‡	3001-57-1	1	3001-56-1	1	3001-56-2	1
39.	Natural smoker orifice‡	3003-68-1	1	3003-68-1	1	3003-68-1	1
40.	Propane smoker orifice‡	3003-77-1	1	3003-77-1	1	3003-77-1	1
41.	Wood chip box assembly	24182-45	1	24182-45	1	24182-45	1
42.	12v / 10 watt halogen bulb‡	24187-15	2	24187-15	2	24187-15	3
43.	Light lens‡	24187-26	2	24187-26	2	24187-26	3
44.	Lamp assembly‡	24187-28	2	24187-28	2	24187-28	3
45.	Power hood motor assembly*	24183-18	1	24183-18	1	24183-18	1
46.	Power hood rocker switch*	24187-39	1	24187-39	1	24187-39	1
47.	Power hood receiver*‡	24187-41	1	24187-41	1	24187-41	1
48.	Power hood transmitter*	24187-42	1	24187-42	1	24187-42	1
49.	Lighted master shut-off switch	24182-46	1	24182-46	1	24182-46	1
50.	Light microswitch	24187-20	1	24187-20	1	24187-20	1
or	Power hood light & motor microswitch	24187-44	1	24187-44	1	24187-44	1
51.	Flash tube (left)‡	24187-29	2	24187-29	2	24187-29	3
52.	Flash tube (right)‡	24187-35	1	24187-35	1	24187-35	1
53.	Flex connector‡	3030-08	1	3030-08	1	3030-08	1
54.	Digital thermometer receiver*	3566	1	3566	1	3566	1
55.	Tool holder	25387-12	1	25387-12	1	25387-12	1
56.	Paper towel holder	25387-11	1	25387-11	1	25387-11	1
57.	Propane tank tray (propane models only)	25386-21	1	25386-21	1	25386-21	1
58.	Propane regulator with hose (propane models only)	5110-15	1	5110-15	1	5110-15	1
59.	Quick-disconnect hose‡ (natural models only)	5110-03	1	5110-03	1	5110-03	1
60.	Power cord‡	25387-13	1	25387-13	1	25387-13	1
61.	Folding shelf	24336-15	1	24336-15	1	24336-15	1
62.	Fire Magic® cookbook‡	3595	1	3595	1	3595	1

* If equipped

‡ Not shown

SINGLE SIDEBURNER UNIQUE PARTS LIST

Item	Description	E660s		E790s		E1060s	
		Part No.	Qty.	Part No.	Qty.	Part No.	Qty.
63.	Sideburner (burner only) ‡	3279-32	1	3279-32	1	3279-32	1
64.	Sideburner assembly w/ shelf	24336-16	1	24336-16	1	24336-16	1
65.	Sideburner grid	3552	1	3552	1	3552	1
66.	Sideburner cap	3275-36	1	3275-36	1	3275-36	1
67.	Sideburner lid	24336-31	1	24336-31	1	24336-31	1

‡ Not shown

DOUBLE SIDEBURNER UNIQUE PARTS LIST

Item	Description	E660s		E790s		E1060s	
		Part No.	Qty.	Part No.	Qty.	Part No.	Qty.
20.	Main control panel†	34393-12	1	34388-12	1	34383-12	1
21.	Main valve manifold	24193-22	1	24188-22	1	24383-28	1
63.	Double sideburner valve manifold	3281-22	1	3281-22	1	3281-22	1
64.	Double sideburner (only)‡	3279-32	2	3279-32	2	3279-32	2
65.	Double sideburner grid	3529-S	1	3529-S	1	3529-S	1
66.	Sideburner cap	3275-36	2	3275-36	2	3275-36	2
67.	Double sideburner cover	3281-07	1	3281-07	1	3281-07	1
68.	Convertible regulator (for double sideburner valve manifold)	PR-4	1	PR-4	1	PR-4	1
69.	Double sideburner control panel	N/A		N/A		23281-12	1

* If equipped

‡ Not shown

† Add (M) to part number for powerhood control panel

Note: See page 4-6 for common part and number identification.

Grills equipped with a double sideburner are available for 660s, 790s, and 1060s series.
1060s shown here.

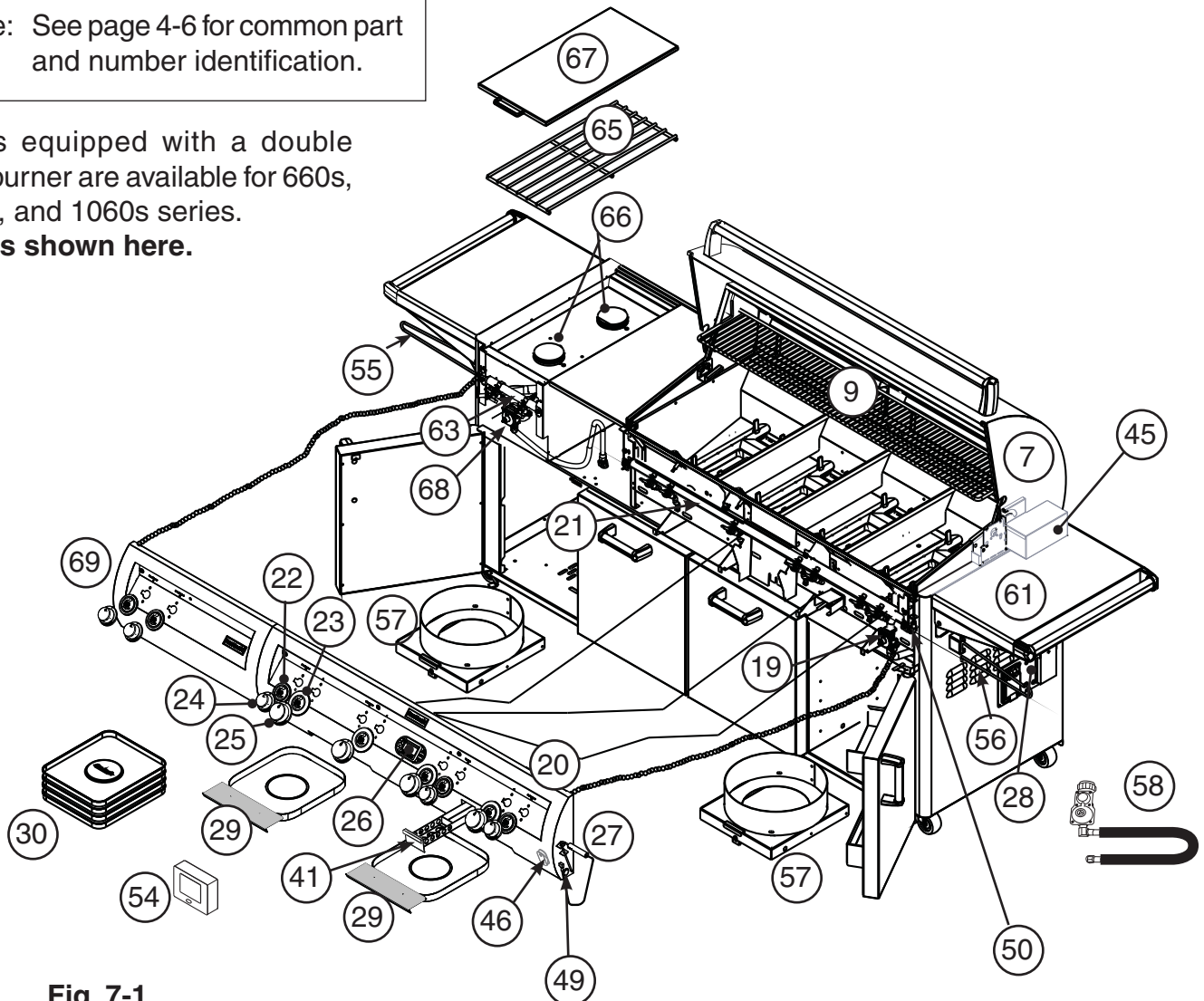

Fig. 7-1

POWER BURNER UNIQUE PARTS LIST

		E1060s	
Item	Description	Part No.	Qty.
20.	Main control panel†	24383-10	1
21.	Main valve manifold	24383-28	1
63.	Power burner valve manifold	3278-14	1
64.	Power burner (only)	3278-01B	1
65.	Power burner grid - stainless steel	3545-S	1
or	Power burner grid - porcelain cast	3545	1
66.	Power burner collimator	3279-09	1
67.	Power burner cover	3278-06	1
68.	Convertible regulator (for power burner valve manifold)	PR-4	1
69.	Power burner control panel	23278-10	1

* If equipped

‡ Not shown

† Add (M) to part number for powerhood control panel

Note: See page 4-6 for common part and number identification.

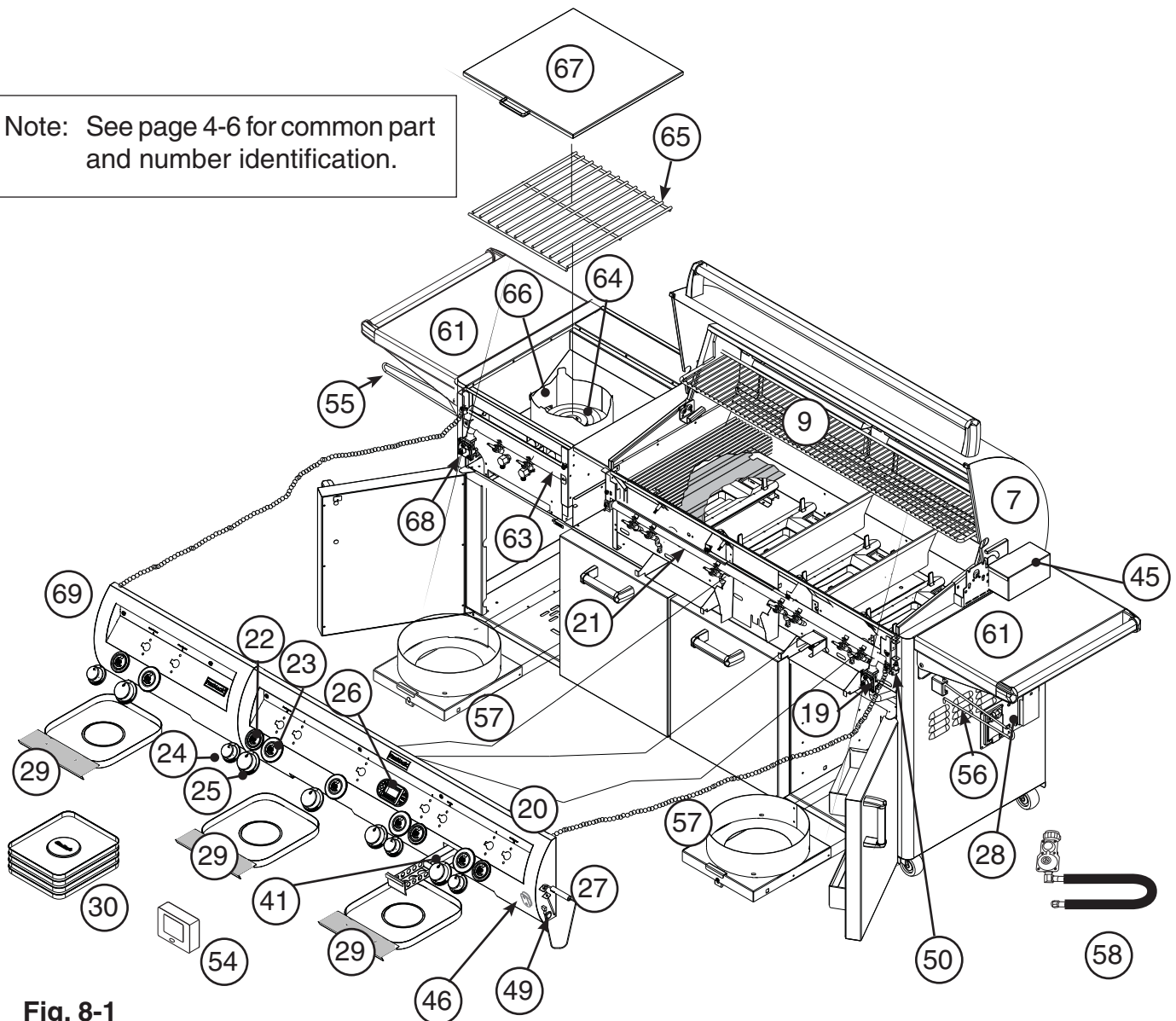

Fig. 8-1

GRILL SAFETY INFORMATION

1. The outdoor grill and surrounding area **MUST** remain clear of flammable substances such as gasoline, yard debris, wood, etc.
2. The airflow through the vent space located below the control panel must remain unobstructed.
3. When using propane gas:
 - a. **The required ventilation openings in the enclosure must be clear of debris.**
 - b. **The propane cylinder, regulator, and rubber hose must be in a location not subject to temperature above 125° F (51° C).**
4. The flames on each burner burn evenly along the entire burner with a steady flame (mostly blue). If burner flames are not normal, check and clean the orifice and burner/venturi tubes for insects and insect nests. A clogged tube can lead to a fire beneath the grill. A proper flame pattern will ensure safe operation and optimal performance. Adjust the air shutter as needed (see AIR SHUTTER ADJUSTMENT).
5. The in-line gas valve or gas cylinder valve must always be shut OFF when the grill is not in use.
6. The drip collector holes must be clear and unobstructed. Excessive grease deposits can result in a grease fire.
7. The backburner, sideburner, or IR burner cover must be removed before using the burner.

WARNING: NEVER cover the *entire* cooking or grill surface with griddles or pans. Overheating will occur, and burners will not perform properly when combustion heat is trapped below the cooking surface.

CAUTION: NEVER spray water on a hot gas unit.

Important: When reviewing this unit's wiring connections; please refer to the wiring diagram label affixed to the inside of the control panel.

ELECTRICAL CONNECTIONS

This grill requires 110 volt AC power to operate.

Use a grounded electrical extension cord rated for outdoor use to connect the grill to line power.

WARNING

Electrical Grounding Instructions

For your protection against shock hazard, this outdoor-cooking gas-appliance is equipped with a three-pronged (grounding) electrical connector. This appliance should be connected to a properly grounded three-prong receptacle using a grounding extension cord rated for outdoor use. Do not cut or remove the grounding prong from the connector.

Important: ONLY REPLACE THE OVEN LIGHTS WITH 12V / 10WATT HALOGEN BULB(S).

MASTER SWITCH

The master switch is push button operated, and is located on the right side of the control panel (see Fig. 9-1). It controls the power to all lights, igniters, and the thermometer. It allows the power to be turned on or off for safety and convenience. The switch will need to be turned on prior to each grill use, and turned off after each use.

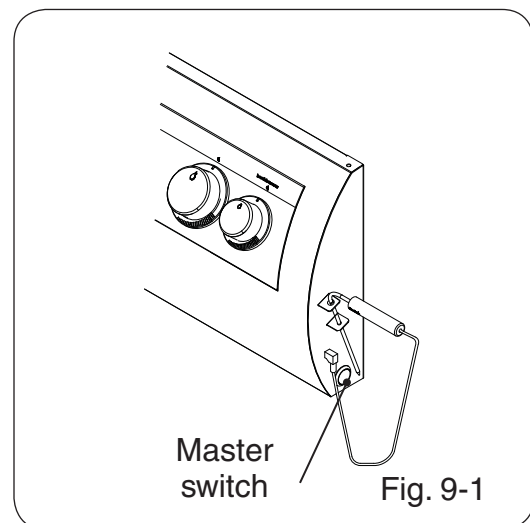

MODEL SPECIFICATIONS TABLE

Fire-Magic® Model Specifications Table

Table 1	E660s	E790s	E1060s
Main burner BTU (per burner) N/P orifice drill size	25,000 #42/#54	32,000 #38/#53	28,000 #40/#53
Backburner BTU (per burner) N/P orifice drill size	19,000 #49/#57	23,000 #44/#56	15,000 #51/#58
Single sideburner BTU N/P orifice drill size	15,000 #50/#58	15,000 #50/#58	15,000 #50/#58
Double sideburner BTU (per burner) N/P orifice drill size	15,000 #50/#58	15,000 #50/#58	15,000 #50/#58
Smoker drawer burner BTU N/P orifice drill size	2,500 #68/#77	2,500 #68/#77	2,500 #68/#77
Infrared searing burner BTU (per burner) N/P orifice drill size	24,000 #45/#55	24,000 #45/#55	24,000 #45/#55
Power burner BTU Left N/P orifice drill size Right N/P orifice drill size	-	-	60,000 #30/#50 #46/#1.25
GFI Receptacle Rating	120V / 10 AMP Max		
Oven Lights Rating	12V / 10 watt halogen bulb		

INSTALL ZONE DIVIDERS

Place the zone dividers as shown (Fig. 10-1) into the grooves in the inner firewall of the grill to allow for maximum heat control and thermometer accuracy in each zone. Remove and store during rotisserie use.

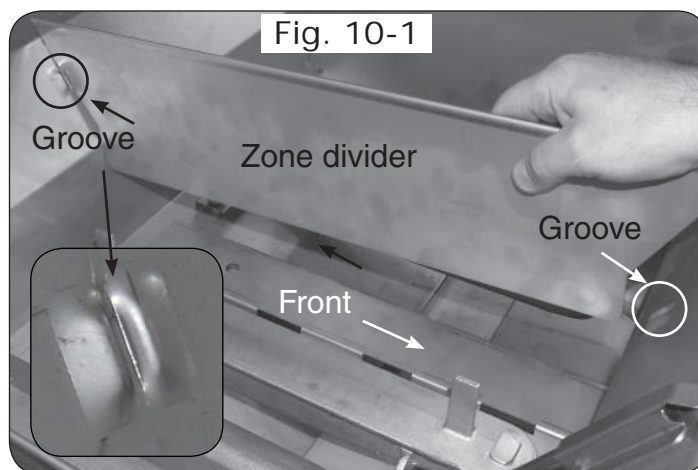

INSTALLATION REQUIREMENTS

This grill is designed for outdoor use only. **DO NOT** use this grill under unprotected flammable surfaces. **DO NOT** use this grill inside a building, garage, enclosed area, or an unprotected covered area (see EXHAUST REMOVAL below). **DO NOT** use this grill in or on a recreational vehicle or boat.

IMPORTANT: This grill is NOT insulated, and therefore the unit, when in operation, must be located with a minimum of 20" (50.7 cm) of side and back clearance from unprotected combustible materials such as wood, plastic, or stucco with wood framing.

The control panel **MUST** remain removable for servicing and air shutter adjustment (see PARTS LIST).

ENSURING PROPER COMBUSTION AIR AND COOLING AIRFLOW

Proper airflow (Fig. 11-1) **MUST** be maintained for the grill to perform as it was designed. If airflow is blocked, overheating and poor combustion will result. Do not block the 1" (2.5 cm) front air inlet along the bottom of the control panel or more than 75% of the cooking grid surface with pans or griddles.

Note: The 1" (2.5 cm) front air space also allows access to the drip tray.

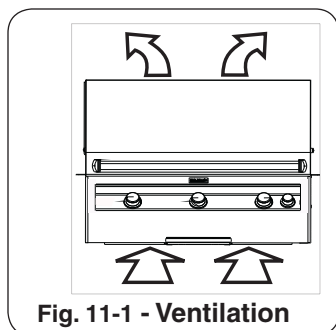

EXHAUST REMOVAL

If installed or used under a patio roof, the cooking grid area must be fully covered by an exhaust hood with a vent. An exhaust fan with a rating of 1,000 CFM (cubic feet per minute) (472 liters per second) or more may be necessary to effectively remove smoke and other cooking by-products from the area under the hood. **Fire Magic Vent Hoods are available to meet this requirement.** This outdoor grill must not be used under unprotected overhead combustible construction. **THIS UNIT MUST NOT BE LOCATED IN A FULLY ENCLOSED AREA OF ANY KIND.**

INCORRECT

Rear oven lid vent



YOU MUST PROTECT REAR OVEN VENT FROM PREVAILING WIND

Fig. 11-2

CORRECT



PLACE GRILL SO PREVAILING WIND BLOWS TOWARD FRONT OF GRILL

Fig. 11-3

CAUTION: Wind blowing into or across the rear oven lid vent (Fig. 11-2) can cause poor performance and/or dangerous overheating. Orient the grill so that the prevailing wind blows toward the front of the grill (Fig. 11-3).

CAUTION: To prevent dangerous overheating, the rear of the unit must have a minimum clearance of 4" (10.2 cm) from any backsplash/wall.

GAS SUPPLY AND MANIFOLD PRESSURES:

For **natural gas** - normal 7" (17.78 cm) water column (w.c.), minimum 5" (12.7 cm), maximum 10 1/2" (26.7 cm). For **propane gas** - normal 11" w.c., minimum 10" (25.4 cm), maximum 13" (33 cm).

INSTALLING THE STAND-ALONE UNIT

LOCATION PREPARATION

Prepare a flat, level surface capable of supporting the weight of the stand-alone grill and convenient to the gas supply if connecting to a gas line.

WHEELS AND CASTERS

To lock a caster press down on the side of the lever with the word "OFF" stamped on it until it stops and the caster will not turn. To unlock, press down on the side stamped "ON."

Caster in locked position

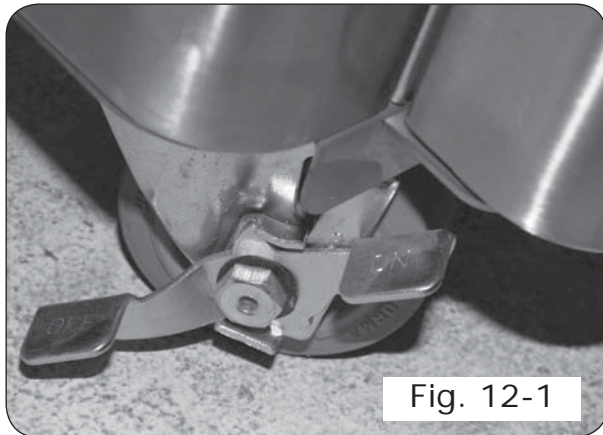

CONNECTING THE GAS SUPPLY

For connecting a propane unit to a portable propane tank, read the safety warnings and follow the instructions in the section SAFE USE AND MAINTENANCE OF PROPANE GAS CYLINDERS.

For household propane or natural gas units:

- a. **Turn OFF the gas supply at the source.** The quick disconnect hose is pre-installed on the valve manifold at the manufacturer. Run the hose through the hole in the bottom rear of the stand-alone unit, to the gas supply. Connect the $\frac{1}{2}$ " NPT socket at the end of the hose to the gas supply. Use pipe joint compound that is resistant to all gasses on the male pipe fitting and tighten securely. **DO NOT use pipe joint compound to connect the flare fittings.**
- c. Turn all burner valves to the **OFF** position. Turn the gas supply on. Then carefully check *all* gas connections for leaks with a brush and soapy water before lighting. **NEVER USE A MATCH OR OPEN FLAME TO TEST FOR LEAKS.**

INSTALL THE TOOL HOLDER AND PAPER TOWEL HOLDER

The rectangular mounting bracket for the tool holder and the paper towel holder come pre-attached to the sides of the cart.

Unpack the holder portion, squeeze the open ends together slightly, and install them into the mounting bracket (see Fig. 12-2). Next, release the hanger so that the ends extend out through the holes in the top and bottom of the mounting bracket (Fig. 12-3, 12-4).

When not in use, the racks may be folded back against the wall of the grill (Fig. 12-3, 12-4).

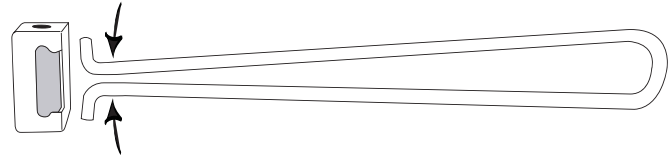

Fig. 12-2

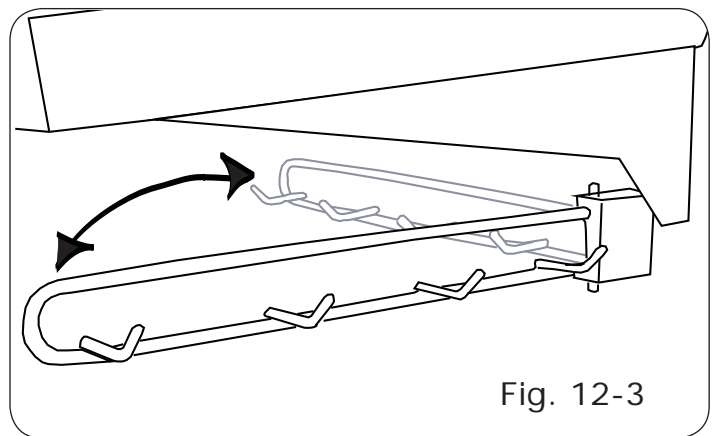

Fig. 12-3

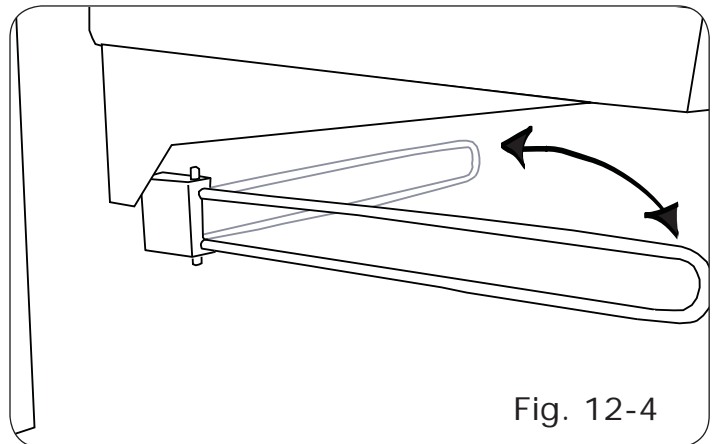

Fig. 12-4

SAFE USE & MAINTENANCE OF PROPANE GAS CYLINDERS

IMPORTANT FOR YOUR SAFETY

READ AND FOLLOW ALL WARNINGS PROVIDED WITH THE PROPANE-GAS CYLINDER.

When operating this appliance with a propane-gas cylinder, these instructions and warnings **MUST** be observed.

FAILURE TO DO SO MAY RESULT IN A SERIOUS FIRE OR EXPLOSION.

CYLINDER/CONNECTOR REQUIREMENTS

- Propane-gas cylinders, valves, and hoses must be maintained in good condition and must be replaced if there is visible damage to either the cylinder or valve. If the hose is cut or shows excessive abrasion or wear, it must be replaced before using the gas appliance (see e.).
- This unit, when used with a cylinder, should be connected to a standard 5-gallon (20 lb.) propane-gas cylinder equipped with an OPD (Overfill Prevention Device). The OPD has been required on all cylinders sold since October 1, 1998, to prevent overfilling.
- Cylinder dimensions should be approximately 12" (30.5 cm) in diameter and 18" (45.7 cm) high. Cylinders must be constructed and marked in accordance with the *Specifications for Propane Gas Cylinders of the U.S. Department of Transportation (D.O.T.)* or the National Standard of Canada, *CAN/CSA-B339, Cylinders, Spheres, and Tubes for Transportation of Dangerous Goods*.
- The cylinder used must include a collar to protect the cylinder valve, and the cylinder supply system must be arranged for vapor withdrawal.
- The pressure regulator and hose assembly (Fig. 13-1) supplied with this outdoor-cooking gas appliance must be used. Original and replacement pressure regulator and hose assemblies must be those specified by the manufacturer for connection with a cylinder connecting device identified as Type I by the *ANSI Z 21.58-2005/CGA 1.6-2005* (see PARTS LIST for ordering information).
- The propane-gas cylinder valve must be equipped with a cylinder connection coupling device, described as Type I in the standard defined in paragraph e. above. This device is commonly described as an Acme thread quick coupler.
- If the propane-gas cylinder comes with a dust plug, place the dust cap on the cylinder valve outlet whenever the cylinder is not in use.

The use of pliers or a wrench should not be necessary. Only cylinders marked "propane" may be used.

To disconnect: Turn the hand nut counterclockwise until detached (Fig. 13-1).

Important: Before using the unit, and after each time the cylinder is removed and reattached, check the hose for wear (see a.) and check all connections for leaks. Turn off the unit valves and open the main cylinder valve, then check connections with soapy water. Repair any leaks before lighting the unit.

CAUTION: Always turn the propane cylinder main valve off after each use, and before moving the unit and cylinder or disconnecting the coupling. This valve must remain closed and the cylinder disconnected while the appliance is not in use, even though the gas flow is stopped by a safety feature when the coupler is disconnected.

Carefully inspect the hose assembly each time before the gas is turned on. A cracked or frayed hose should be replaced immediately.

If the appliance is stored indoors, the cylinder must be disconnected and removed. Disconnected cylinders must be stored outdoors, out of the reach of children, with threaded valve plugs tightly installed, and must not be stored in a building, garage, or any other enclosed area.

FOR YOUR SAFETY

- DO NOT store a spare propane-gas cylinder under or near this appliance.
- NEVER fill the cylinder beyond 80-percent full.
- IF THE INFORMATION IN a. AND b. IS NOT FOLLOWED EXACTLY, A FIRE CAUSING DEATH OR SERIOUS INJURY MAY OCCUR.

Fig. 13-1 Type I Acme thread quick coupler

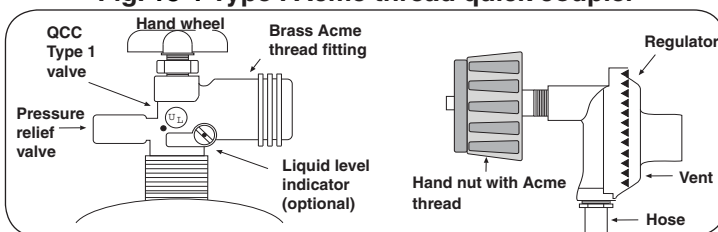

QUICK COUPLER OPERATION

To connect the regulator/hose assembly to the propane-gas cylinder valve fitting: Press the hand nut on the regulator over the Acme thread fitting on the cylinder valve. Turn the hand nut clockwise to engage the threads and tighten until snug.

SECURING THE PROPANE-GAS CYLINDER



Fig. 13-2

- Lift latch handle to unlock tray and pull outward.

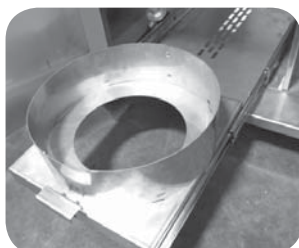

Fig. 13-3

- Set propane-gas cylinder into the sleeve of the extended tray with base inserted into center hole and collar opening to back. Follow instructions above to connect supply.

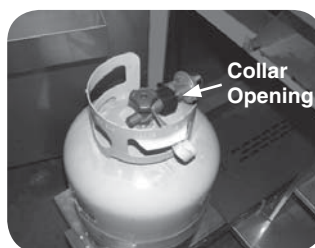

Fig. 13-4

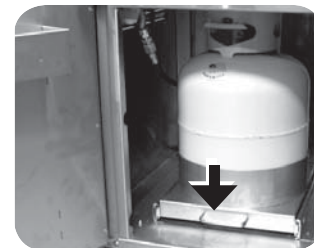

Fig. 13-5

- With gas cylinder in place and connected, slide tray back into cart and lock latch handle by pushing firmly downward.

UTILISATION SÛRE ET ENTRETIEN DES CYLINDRES DE GAZ

IMPORTANT POUR VOTRE SÛRETÉ

LISEZ ET SUIVEZ TOUS LES AVERTISSEMENTS ÉQUIPÉS DE VOTRE CYLINDRE DE GAZ DE PROPANE.

En actionnant cet appareil avec un cylindre de gaz de propane ON DOIT observer ces instructions et avertissements.

LE MANQUE DE FAIRE AINSI PEUT AVOIR COMME CONSÉQUENCE UNE INCENDIE OU UNE EXPLOSION SÉRIEUSE.

CYLINDRE ET CONDITIONS ET

CARACTÉRISTIQUES DE CONNECTEUR

- Des cylindres et les valves de gaz de propane doivent être maintenus en bon état et doivent être remplacés s'il y a des dommages évidents au cylindre ou à la valve.
- Ce gril, une fois utilisé avec un cylindre, devrait être relié à un gallon de la norme 5 (20lb.) cylindre de gaz de propane équipé d'un OPD (remplissez au-dessus du niveau le dispositif d'empêchement). L'OPD a été exigé sur tous les cylindres vendus depuis octobre 1.1998 pour empêcher le remplissage excessif.
- Les dimensions de cylindre devraient être approximativement 12" (30.5cm) de diamètre et 18" (45.7cm) hauts. Des cylindres doivent être construits et marqués selon les caractéristiques pour des cylindres de gaz de propane du département des ETATS-UNIS du transport (D.O.T.) ou le niveau national du Canada, du CAN/CSA-B339, des cylindres, des sphères et des tubes pour le transport des marchandises dangereuses.
- Le cylindre doit inclure un collier pour protéger la valve de cylindre et le circuit d'alimentation de cylindre doit être assuré le retrait de vapeur.
- Le régulateur de pression et l'ensemble de tuyau (fig. 14-1) fourni avec cet appareil à cuire extérieur de gaz doivent être utilisés. Les régulateurs d'original et de pression de remplacement et les ensembles de tuyau doivent être ceux indiqués par le fabricant pour le raccordement avec un dispositif se reliant de cylindre identifié comme type I par la norme ANSI Z 21.58-2007/CGA 1.6-2007 avec la norme ANSI Z 21.58a -1998 d'addenda et CGA 1.6a - M98.
- La valve de cylindre de gaz de propane doit être équipée d'un dispositif d'accouplement de raccordement de cylindre, décrit comme type I dans la norme définie dans le e. de paragraphe ci-dessus. Ce dispositif est généralement décrit comme coupleur rapide de fil de point culminant.
- Si votre cylindre de gaz de propane vient avec une prise de la poussière, placez le bouchon anti-poussière sur la sortie de valve de cylindre toutes les fois que le cylindre n'est pas en service.

OPÉRATION DE COUPLEUR RAPIDE

Pour relier le régulateur/hose à l'ajustage de précision de valve de cylindre de gaz de propane: Serrez l'écrou de main sur le régulateur au-dessus de l'ajustage de précision de fil de point culminant sur la valve de cylindre. Tournez l'écrou de

main dans le sens des aiguilles d'une montre pour engager les fils et pour serrer jusqu'à ce que douillettement. L'utilisation des pinces ou de la clé ne devrait pas être nécessaire. Seulement le propane marqué par cylindres doit être employé.

Pour débrancher: Tournez l'écrou de main dans le sens contraire des aiguilles d'une montre jusqu'à isolé (fig. 14-1).

Important: Avant d'employer le gril, et ensuite chaque fois que le cylindre est enlevé et rattaché, examinez tous les raccordements pour déceler les fuites. Arrêtez les valves de gril et ouvrez la valve principale de cylindre, puis vérifiez les raccordements avec de l'eau savonneuse. Réparez toutes les fuites avant d'allumer le gril.

ATTENTION: Tournez toujours la valve principale de cylindre de propane au loin après chaque utilisation, et avant de déplacer le gril et le cylindre, ou débrancher l'accouplement. Cette valve doit rester fermée et le cylindre a débranché alors que l'appareil n'est pas en service, quoique l'écoulement de gaz soit arrêté par un dispositif de sûreté quand le coupleur est débranché.

Inspectez soigneusement l'ensemble de tuyau chaque fois avant que le gaz soit allumé. Un tuyau criqué ou frangé devrait être remplacé immédiatement.

Si l'appareil est stocké à l'intérieur, le cylindre doit être disconnected et a enlevé. Des cylindres Disconnected doivent être stockés dehors, hors de la portée des enfants, avec les prises de valve filettées étroitement installées, et ne doivent pas être stockés dans un bâtiment, le garage, ou n'importe quel autre secteur inclus.

POUR VOTRE SÛRETÉ

- Ne stockez pas un cylindre de gaz disponible de propane dessous ou ne vous approchez pas de cet appareil.
- Ne remplissez jamais cylindre au delà de 80 pour cent de plein.
- SI L'INFORMATION DANS "A" ET "B" N'EST PAS SUIVIE EXACTEMENT, UN FEU CAUSANT LA MORT OU DES DOMMAGES SÉRIEUX PEUT SE PRODUIRE.

Fig. 14-1 type coupleur rapide de fil de point culminant d'I

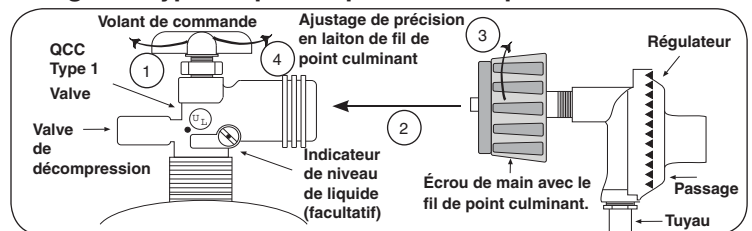

FIXATION DU CYLINDRE DE GAZ DE PROPANE

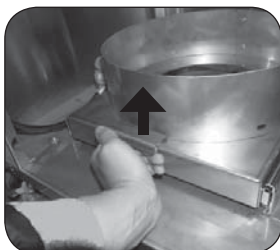

Fig. 14-2

1. Soulevez la poignée de verrouillage pour ouvrir le plateau et pour tirer à l'extérieur.

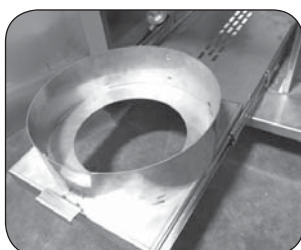

Fig. 14-3

2. Placez le cylindre de gaz de propane gainant fermement sur le plateau avec la base insérée dans le trou central et le collier s'ouvrant au dos. Suivez les instructions de relier ci-dessus l'approvisionnement.



Fig. 14-4



Fig. 14-5

3. Avec le cylindre de gaz en place et relié, glissez le plateau de nouveau dans la poignée de verrouillage de chariot et de serrure en poussant fermement en bas.

INSTALLING THE SIDEBURNER SHELF

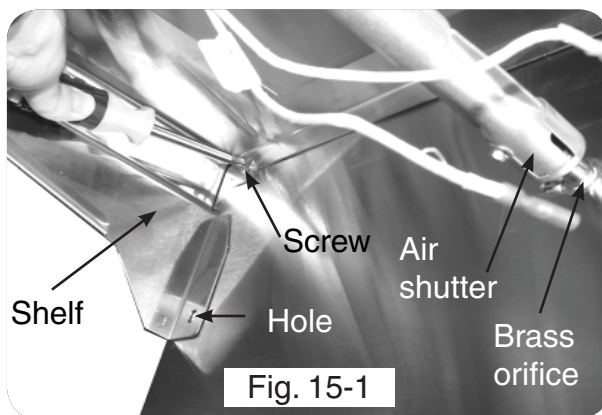

Air-shutter orifice placement - under shelf

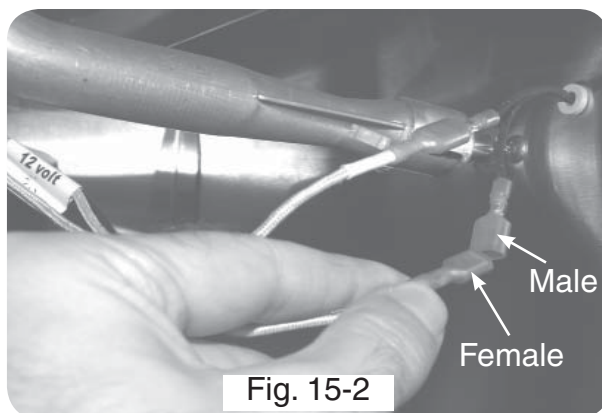

Connecting the ignitor wires

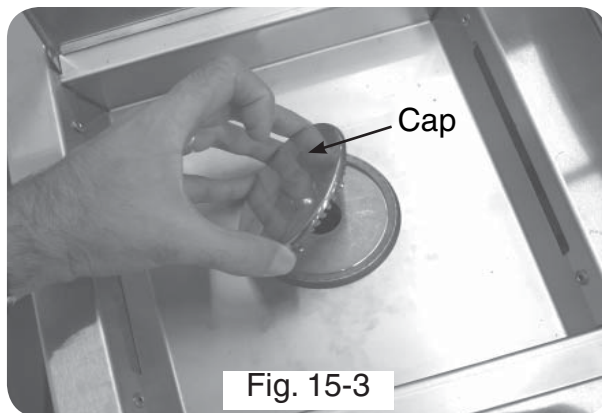

Placing the burner cap

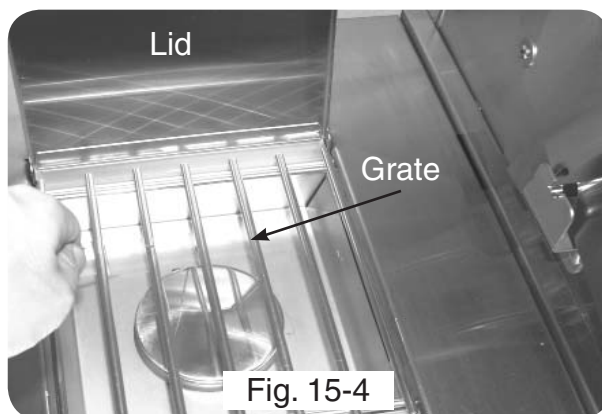

Final look

This shelf comes separate from the grill for convenience in shipping. The sideburner shelf must be installed using the following instructions before hooking up the grill to a gas source.

INSTALLING THE SIDEBURNER SHELF →

1. Remove the protective plastic from the grill, sideburner, and sideburner lids by carefully peeling it off with your fingers. Do not use tools.
2. Hold the sideburner shelf up against the left side wall of the grill so that the holes in the shelf line up with the four (4) threaded screw holes in the side wall and the air-shutter end of the sideburner venturi tube fits around the brass orifice protruding from the side of the cart.

WARNING: It is critical for safety and for the proper function of the sideburner that the sideburner venturi tube with air shutter be centered around and completely cover the gas orifice.

3. Insert and start screws with fingers and then tighten using a Phillips screwdriver.

Note: Upon completion, the air shutter must still fit around the brass orifice.

4. Connect the female connectors on the ends of the hot surface ignitor wires to the male connectors coming from inside the grill.
5. Place the burner cap on top of the burner, as shown in Fig. 15-3.
6. Place the grid so that it rests on the front and back lips of the sideburner opening (Fig. 15-4).
7. Proceed to the section on AIR SHUTTER ADJUSTMENT and complete the installation by adjusting the air shutter. This will also test the sideburner installation.

IDENTIFICATION OF GRILL CONTROLS

E1060s control locations

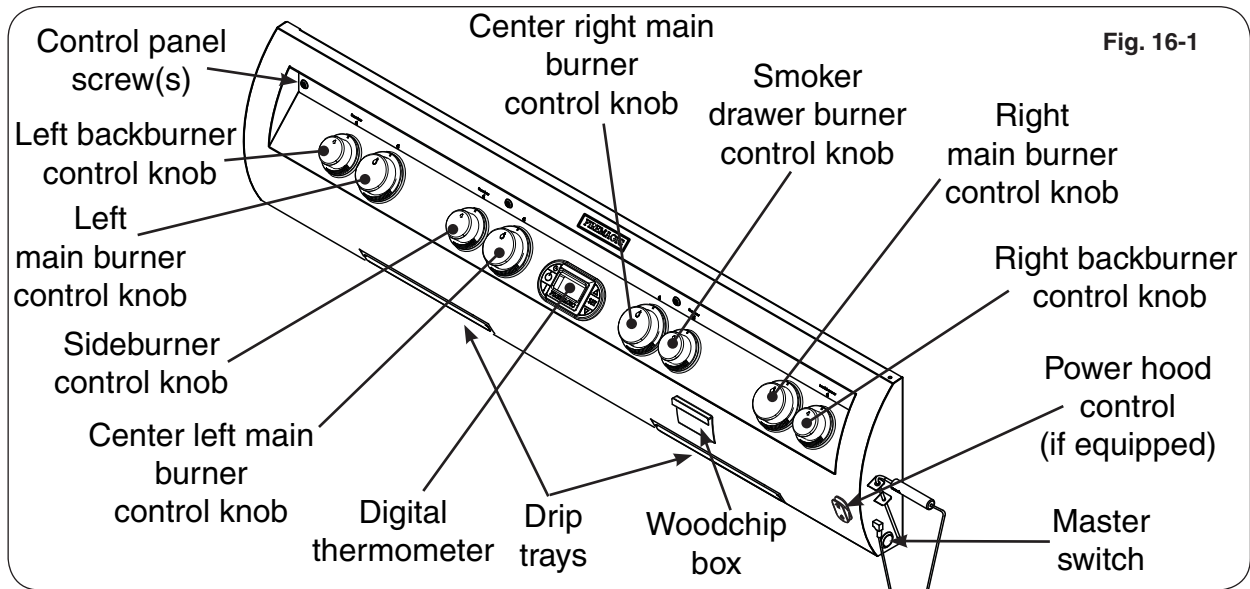

Power burner control locations

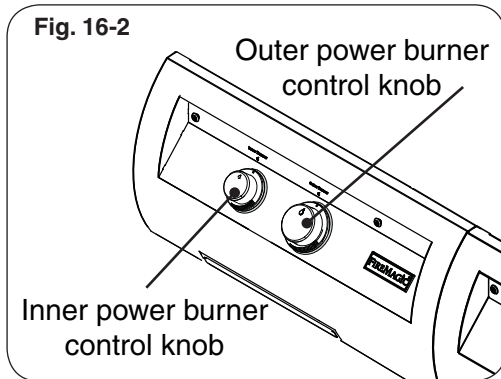

Double sideburner control locations

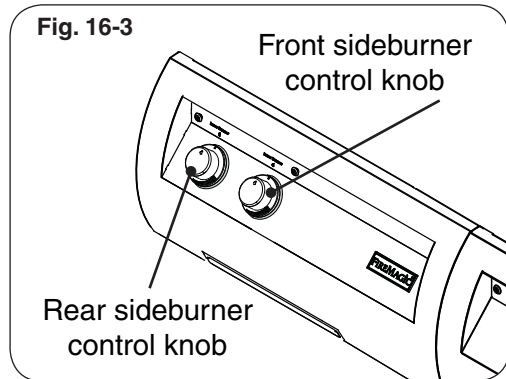

E660s and E790s control locations

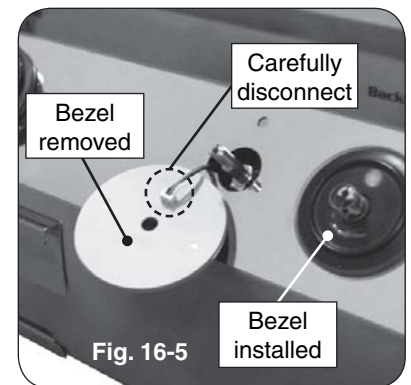
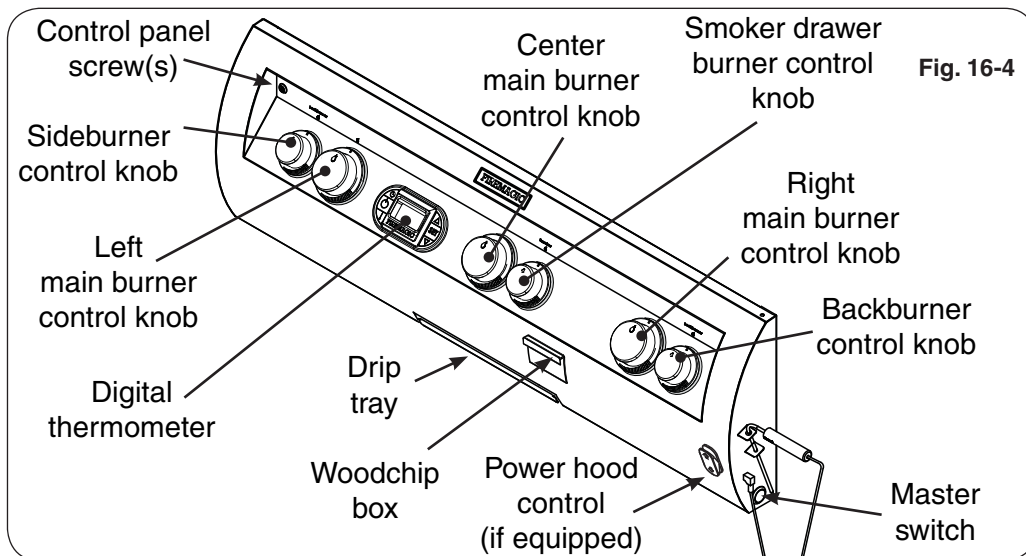

To remove the control panel:

- Turn off the gas shutoff valve.
- Pull off the control knobs. Slowly lift away the lighted bezels to clear the valve stems, and carefully disconnect the wires found on the back of the bezels (use your fingernail.) Remove the woodchip box. Unscrew and remove the control panel screws and washers.
- Lift the control panel up and outward, allowing it to rest on the internal chain(s).

Important: When re-installing the control panel, set it back over the front lip of the grill so that the lid-closed-sensor plunger protrudes through the hole on the upper right of the control panel. Prior to opening the gas shutoff

OPTIONAL POWERHOOD

The Fire Magic® Power Hood is available only as an Echelon E1060 factory shipped option. Read the following before using the grill.

Important: Grill must be connected to electrical power to open and close lid by motor.

OPENING AND CLOSING THE LID BY REMOTE OR CONTROL PANEL ROCKER SWITCH →

Note: See below for manual operation procedure.

While set up for motorized opening and closing, the lid may be controlled either by the black rocker switch on the right side of the control panel or by the remote control included with units configured with the motorized lid option.

The rocker switch will lock in any one of three positions: **up**—commanding the lid to open, **down**—commanding the lid to close, and **center**—allowing the lid to hold its current position and respond to remote control.

For safety reasons, the rocker switch on the control panel will always override the remote control.

To enable remote control of the lid, set the rocker switch to center.

To open the lid, press and hold the **open** button on the remote until the lid reaches the desired location. Then release the remote buttons, and the lid will stay in place.

To close the lid, press and hold the **close** button on the remote until the lid reaches the desired location. Then release the remote buttons, and the lid will stay in place.

If the rocker switch is left in the **down** position, remote up commands will affect the lid only as long as the remote button is held. When released, the motor will move the lid back to the closed state. With the rocker switch in the **up** position, the remote has no effect.

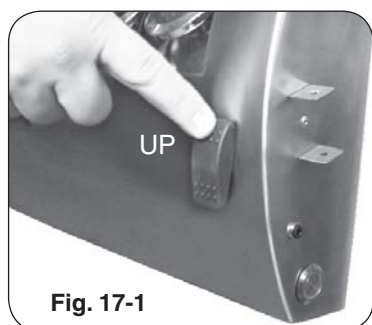

Fig. 17-1

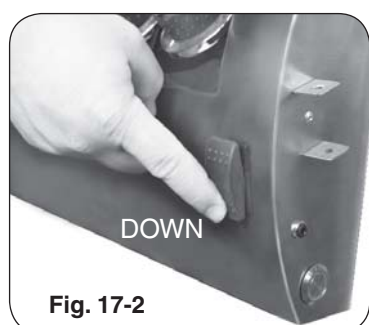

Fig. 17-2

CONFIGURING THE LID FOR MANUAL OPENING AND CLOSING →

WARNING

If the grill has been on recently, all Power Hood components are potentially hot. Wait for grill to cool before beginning this procedure or wear heat-resistant gloves.

CAUTION: Do not push or pull on the lid or its handle while it is configured for automatic operation. This could result in damage to the grill.

To configure the lid for manual opening and closing, simply remove the locking bolt using the following procedure. This procedure requires the use of the Allen wrench supplied with this option.

1. Open the lid completely, then set the rocker switch to the center position and disconnect electrical power to the unit.
2. Use a Phillips screwdriver to remove the stainless-steel motor assembly housing screw. Pull the top of the housing first up and then outward away from the lid until the top of the shroud clears the lip of the motor mount beneath, then remove the housing completely and set it aside (Fig. 17-3).
3. Use the Allen wrench to loosen and remove the lid motor assembly locking bolt and washer (see next page).

Important: Keep this bolt and washer for later use in converting the unit back to automatic lid operation.

4. Replace the motor assembly housing and refasten.

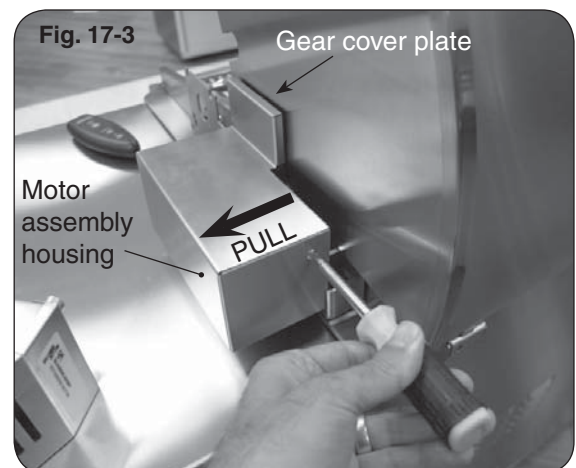
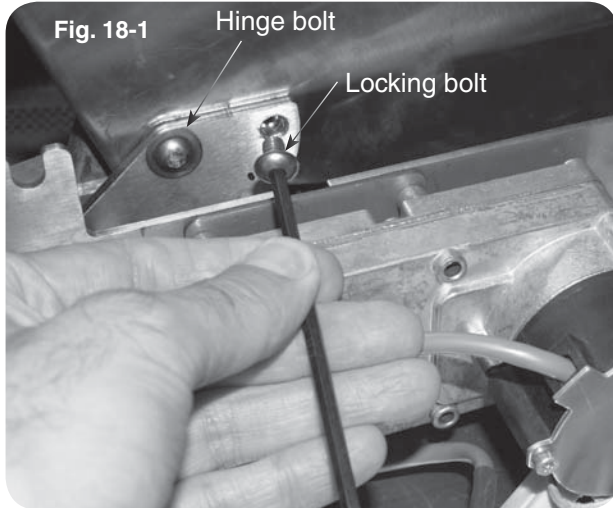

Fig. 17-3

OPTIONAL POWERHOOD



CONFIGURING THE LID FOR AUTOMATIC OPENING AND CLOSING

The unit is shipped in this configuration, but if you have configured it for manual operation and wish to use the automatic open/close function again, follow this procedure to configure for automatic operation:

1. Follow steps 1-4 on the previous page except screw in the locking bolt in step 3.
2. Switch the receiver to the AUTO position (see SYNCHRONIZING TRANSMITTER AND RECEIVER instructions below).

TURNING ON THE TRANSMITTER

The transmitter has a AUTO/OFF switch, a sync. switch and an indicator LED on it. The AUTO/OFF switch must be in the Auto position for the remote transmitter to control the motorized oven lid.

INSTALLING/CHANGING THE BATTERIES IN THE TRANSMITTER

Slide open the battery access door on the back of the Power Hood remote. Remove the 12-volt camera battery and replace it. Close the access door and follow the instructions on synchronizing the remote below.

SYNCHRONIZING TRANSMITTER AND RECEIVER

The first time you turn on the transmitter or after changing batteries in the transmitter, it is necessary to synchronize the transmitter with the receiver.

To do this, use a pen to press in the synch button on the receiver (Fig. 18-2). The green LED will begin to flash. While the LED is flashing, press either the up or down button on the remote transmitter. The LED will go out. Then press the On/Off button on the transmitter.

The units are now synchronized. Test this by commanding the lid up or down as appropriate.

The units may be synchronized at any time.

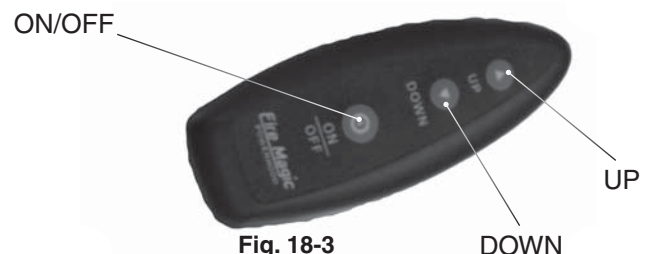
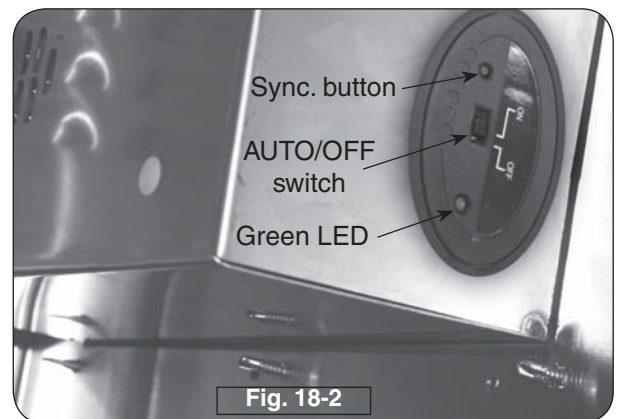

LIGHTING (IGNITION) INSTRUCTIONS

Read all instructions before lighting, and follow these instructions each time you light the unit.

ELECTRONIC LIGHTING

Note: Unit must be connected to 110VAC power for electronic lighting.

1. Open lid(s) or remove cover(s) from burner(s) to be lit.
2. Turn all gas control knob(s) to their **OFF** position(s).
3. Turn on the gas at its source.

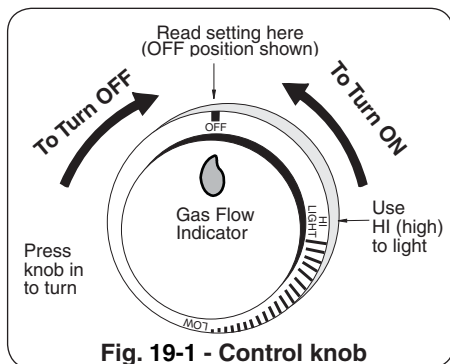

Note: DO NOT turn on more than one valve at a time for either electronic or manual lighting.

4. Depress the desired control knob **for 5 seconds**, and while pressing turn it counterclockwise to the **HI LIGHT** position. Once the burner lights, release the knob.

CAUTION: If a burner does not light within five (5) *seconds* of turning on the control knob, depress the knob and turn it to the **OFF** position. **WAIT FIVE (5) MINUTES** before repeating step 4. If you smell gas, follow the instructions on the cover of this manual. If the burners still do not light after several attempts, refer to the instructions for manual lighting.

5. Repeat step 4 for each additional burner to be lit.

Important: When lighting the burner under the flavor/smoker drawer, first remove the drawer so that the burner can be easily seen. Then replace the drawer after the burner is lit.

WHEN USING A PORTABLE PROPANE TANK

Propane tanks are equipped with a safety shutdown device that may cause low or no gas pressure/flame at the burners if operating and lighting instructions are not followed exactly (See important note in the TROUBLESHOOTING section for more details.)

MANUAL LIGHTING

CAUTION: Always wait five (5) minutes for gas to clear after any unsuccessful lighting attempt.

1. Follow steps 1 through 3 (left).
2. Insert either a burning long-barrel butane lighter or a burning long-stem match through the cooking grid opening to the top of the lighting tube. (Fig. 19-2). For backburners, hold the flame against the perforated material of the backburner. For sideburners, hold the flame against the burner.
3. While holding the match or lighter flame at the top of the lighting tube or next to the burner (sideburner and backburner only), depress the desired control knob and while pressing turn it counterclockwise to the **HI LIGHT** position. Remove the lighter or match when the burner lights, and release the control knob.
4. If the burner does not light, **immediately depress the knob and turn the valve to OFF**. **WAIT FIVE (5) MINUTES** before repeating steps 2 through 4 of the MANUAL LIGHTING instructions.

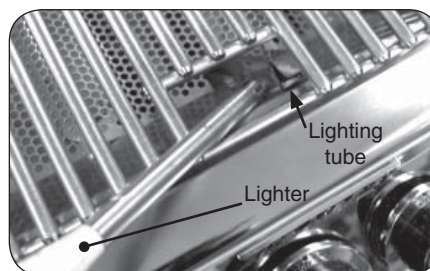

Fig. 19-2 - Manual lighting

SHUTTING OFF THE UNIT

To shut off the unit, depress each valve control knob and, while pressing turn it clockwise to the **OFF** position.

Always close the valve from the gas supply after each use of the unit.

For your convenience and safety; when the control knob is in the on position, the gas flow indicator will change from blue to red. (Red indicates gas flow.) See Fig. 19-1.

ALLUMAGE DES INSTRUCTIONS (D'ALLUMAGE)

Lisez toutes les instructions avant l'allumage, et suivez ces instructions chaque fois vous lumière le unité.

ÉCLAIRAGE ÉLECTRONIQUE

Note: Le unité doit être relié à la puissance 110VAC pour l'éclairage électronique.

1. Ouvrez les couvercles ou enlevez les couvertures des brûleurs pour être Lit.
2. Tournez tous les boutons de commande de gaz à leurs positions de repos.
3. Allumez le gaz à sa source.

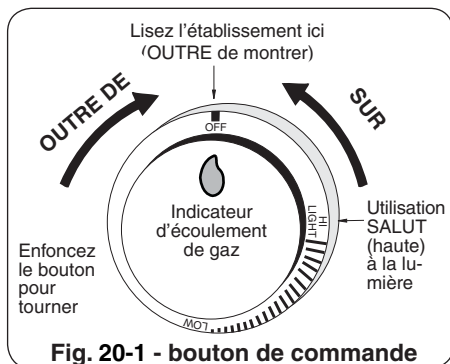

Note: N'ouvrez pas plus d'une valve à la fois pour l'éclairage électronique ou manuel.

4. Diminuez le bouton de commande désiré pendant 5 secondes, et tout en pressant le tour il dans le sens contraire des aiguilles d'une montre dans la position LÉGÈRE de HI. Une fois que le brûleur s'allume, libérez le bouton.

ATTENTION : Si un brûleur ne s'allume pas dans cinq (5) secondes d'allumer le bouton de commande, enfoncez le bouton et tournez-le à la position de repos. ATTENDEZ CINQ (5) MINUTES avant de répéter l'étape 4. Si vous sentez le gaz, suivez les instructions sur la couverture de ce manuel. Si les brûleurs ne s'allument toujours pas après que plusieurs tentatives, se rapportent aux instructions pour l'éclairage manuel.

5. Répétez l'étape 4 pour que chaque brûleur additionnel soit Lit.

Important: En allumant le brûleur sous le tiroir de saveur/fumeur, enlevez d'abord le tiroir de sorte que le brûleur puisse être facilement vu. Remplacez alors le tiroir après que le brûleur soit Lit.

EN EMPLOYANT UN RÉSERVOIR DE PROPANE PORTATIF

Des réservoirs de propane sont équipés d'un dispositif d'arrêt de sûreté qui peut ne pas causer le bas ou aucunes pression de gaz/flamme aux brûleurs si le fonctionnement et l'allumage des instructions ne sont pas suivis exactement (voir la note importante dans la section de dépannage pour plus de détails.)

ÉCLAIRAGE MANUEL

ATTENTION: Attendez toujours cinq (5) minutes le gaz pour se dégager après que n'importe quelle tentative non réussie d'éclairage.

1. Suivez les étapes 1 à 3 (à gauche).
2. Passez un allumeur brûlant de butane de long-baril ou une allumette brûlante de long-tige dans la grille à cuire s'ouvrant au dessus du tube d'éclairage. (Fig. 20-2). Pour des backburners, tenez la flamme contre le matériel perforé du backburner. Pour des sideburners, tenez la flamme contre le brûleur.
3. Tout en tenant l'allumette ou la flamme plus légère au dessus du tube d'éclairage ou à côté du brûleur (sideburner et backburner seulement), diminuez le bouton et tout en pressant le tour de commande désirés il dans le sens contraire des aiguilles d'une montre dans la position LÉGÈRE de HI. Enlevez l'allumette ou assortissez quand le brûleur s'allume, et libérez le bouton de commande.
4. Si le brûleur ne s'allume pas, enfoncez immédiatement le bouton et tournez la valve à AU LOIN. ATTENDEZ CINQ (5) MINUTES avant de répéter les étapes 2 à 4 des instructions manuelles d'éclairage.

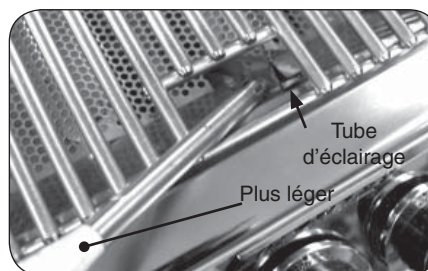

Fig. 20-2 - Éclairage manuel

ARRÊT DU UNITÉ

Pour couper le unité, diminuez chaque bouton de commande de valve et, et tout en pressant tour il dans le sens des aiguilles d'une montre à la position de repos.

Fermez toujours la valve de la fourniture de gaz après chaque utilisation du unité.

Pour votre convenance et sûreté ; quand le bouton de commande est dans la position de fonctionnement, l'indicateur d'écoulement de gaz changera de bleu en le rouge. (Le rouge indique l'écoulement de gaz.) Voir la Fig. 20-1.

DIGITAL THERMOMETER / INTERIOR AND KNOB LIGHTS

Your grill comes with a digital thermometer for temperature monitoring and timed cooking. Pressing **any** button will turn on the thermometer. The thermometer will automatically shut off after 5 minutes if no temperature change is detected.

Note: The thermometer also controls the interior lights, and knob backlights. Thermometer shutdown will not shut off these lights; they must be manually shut off.

The thermometer is located on the control panel between the control knobs.

Plug in the meat probe on the right side of the control panel as shown in Fig. 21-1.

For best performance and temperature readings center the zone separators properly between each burner (see PARTS LIST).

Read the following sections completely regarding thermometer operation. Refer to Fig. 21-2 for thermometer orientation and button locations.

Prior to initial use; calibrate the thermometer (following page). Whenever the master switch is turned off or the power supply is disconnected, allow 30 seconds for the thermometer to initialize the next time it is powered on.

DEFAULT SCREEN

Press any button to turn the thermometer On. The default screen will be displayed. All temperatures for the cooking zones (see Grilling Tips section) and the meat probe will be shown (Fig. 21-3). See below for options under the default screen.

Setting a Location Temperature

1. Press the up/down arrow to switch to the desired location (a cooking zone or the meat probe). Press **SET**.
2. The selected location's temperature screen will be displayed. Use the arrows to set the desired temp. The actual temp. will also be shown. (See Fig. 21-4.)

Note: PRESSING the arrows will adjust the desired temp. by increments of one. HOLDING them down (for several seconds) will adjust the temp. rapidly.

3. Press **SET** to return to the default screen. Repeat as necessary for all other locations.

The alarm will sound (if set to do so) when a location reaches its set temperature. The alarm is silenced by pressing any button on the thermometer.

Interior and Knob Lights

1. Press the light button to turn both the interior lights and knob backlights On. The interior lights will temporarily shut off when the hood is closed (except for Magic View models).
2. Press the light button once to turn the interior lights off, and a second time to turn the knob backlights off.

Note: Thermometer shutdown will not shut off these lights; they must be manually shut off by turning the thermometer back on and pressing the light button.

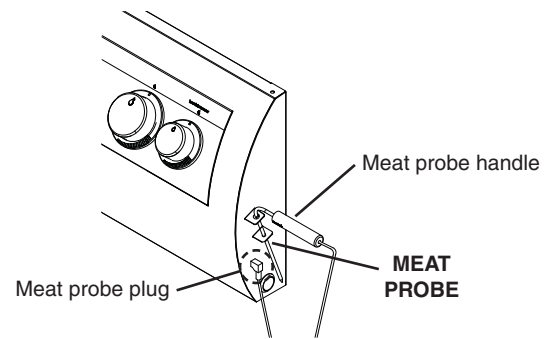

Fig. 21-1 Meat probe detail

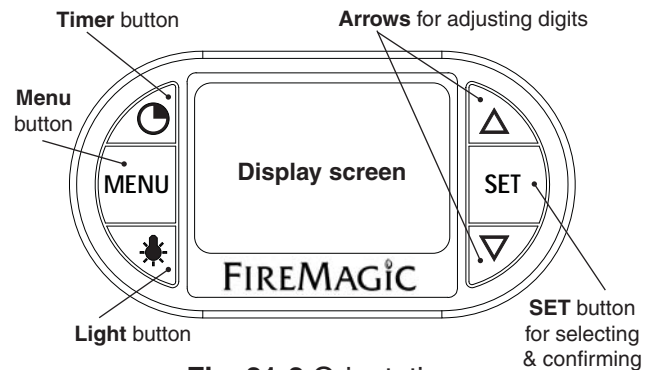

Fig. 21-2 Orientation

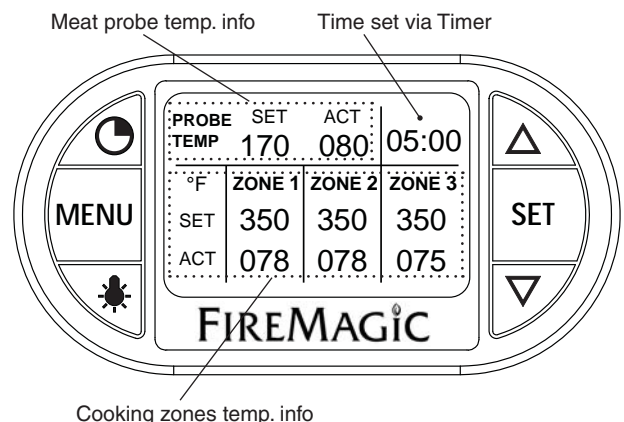

Fig. 21-3 Default screen detail

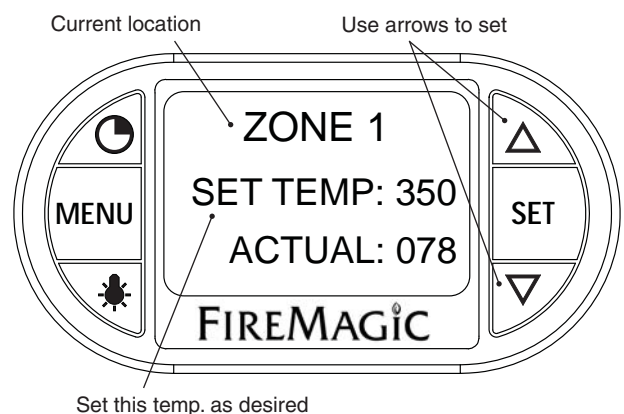

Fig. 21-4 Location temp. screen (zone 1 shown)

DIGITAL THERMOMETER / INTERIOR AND KNOB LIGHTS (Cont.)

Setting the Timer

1. Press the timer button. Use the arrows to set the desired amount of time (see Fig. 22-1.)
2. Press **SET** to return to the default screen.

The time remaining will be shown on the default screen. Once the time reaches zero; the alarm will sound. The alarm is silenced by pressing any button on the thermometer.

MENU SCREEN

Press any button to turn the thermometer On. The default screen will be displayed. Press the **MENU** button to display its screen. Press the up/down arrow to scroll through the options. (See Fig. 22-2.) See below for options under the menu screen.

Note: The menu screen will return back to the default screen after approximately 30 seconds of no activity. Press the **MENU** button to manually return to the default screen.

Changing temperature units (°C/°F) / Calibrating

1. Under the menu screen select SETUP. Press **SET**.
2. Press the up/down arrow to select (by pressing **SET**):
 - **SETUP F C.** This will allow you to press the up/down arrow to select the desired temperature unit (°C/°F). Press **SET** to return to the menu screen.
 - **CALIBRATE.** This will calibrate the thermometer with the ambient temperature, and return to the menu screen.

Grill Guide and Meat Probe

The grill guide displays recommended ready temperatures for various meats.

1. Under the menu screen select GRILL GUIDE. Press **SET**.
2. Press the up/down arrow to view the desired meat.
3. Note the temp. and press **SET**. This will take you to the meat probe temperature screen.
4. Use the arrows to set the noted temp.
5. Press **SET** to return to the default screen.

Putting the meat probe into the cooking meat will give an actual temp. reading. The alarm sounds when the actual temp. reaches the set temp.

Note: Do not leave the meat probe in the meat for a prolonged period of time, or with the hood closed.

Setting the Alarm

The alarm can be individually set (On or Off) for the meat probe and each cooking zone. The default setting has the alarm Off for the meat probe and cooking zones. The alarm always sounds for the Timer.

1. Under the menu screen select ALARM. Press **SET**.
2. Use the up/down arrow to select the desired alarm, and press the light button to turn the alarm On/Off.
3. Press **SET** to return to the menu screen.

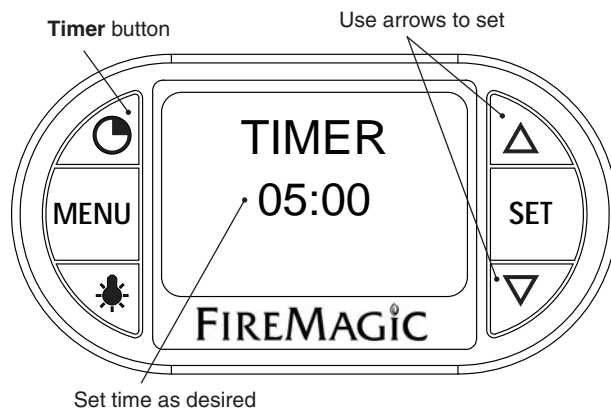

Fig. 22-1 Timer screen



Fig. 22-2 Menu screen

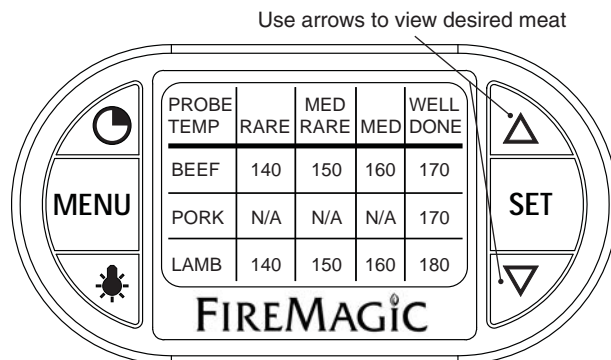

Fig. 22-3 Grill Guide screen

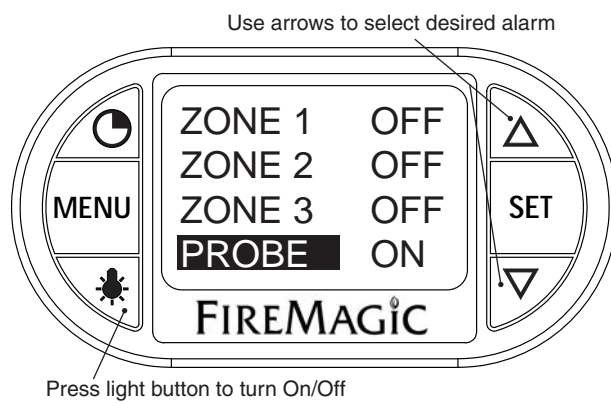

Fig. 22-4 Alarm screen

DIGITAL THERMOMETER / INTERIOR AND KNOB LIGHTS (Cont.)

Setting the Thermometer Backlight

The default color for the thermometer backlight is blue. The color may be changed as desired by turning the three base colors On/Off. Various combinations will result in different colors.

1. Under the menu screen select BACKLIGHT. Press **SET**.
2. Use the up/down arrow to select the desired color, and press the light button to turn the color On/Off.
3. Press **SET** to return to the menu screen. The new color will now show.

Note: Turning all colors Off will result in no backlight.

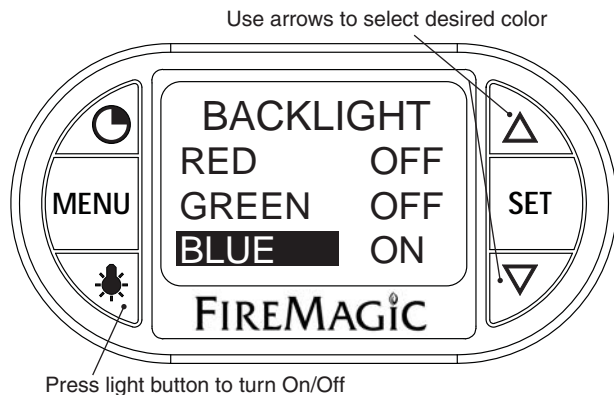

Fig. 23-1 Backlight screen

REMOTE RECEIVER (optional)

The receiver will display data transmitted from the thermometer, and sound when the thermometer alarm sounds. It can also set the meat probe temperature, and take a meat probe temperature reading (when the meat probe is connected to the receiver).

Note: Although the cooking zone temperatures and alarm may be set through the receiver, they will always be over-riden by the data transmitted from the thermometer.

Refer to Fig. 23-2 for receiver orientation.

As the receiver displays the same data, and functions the same as the thermometer; this section will reference some previous thermometer information.

Read this section completely, then sync the receiver with the thermometer (following page), prior to receiver use.

DEFAULT SCREEN

Press the power button to turn the receiver On. The default screen will be displayed. All temperatures for the cooking zones and the meat probe will be shown (see Fig. 23-3). See below for options under the default screen.

The receiver display will automatically shut off after 30 seconds of no activity. Two minutes after thermometer shut off; the receiver will go into a deep sleep, which will minimize battery usage. **To manually shut off the receiver; press and hold the power button.**

Viewing/Setting a Location Temperature

All location temperatures (cooking zones/meat probe) can be viewed in a detail screen.

1. Press the up/down arrow to switch to the desired location (a cooking zone or the meat probe). Press **SET**.
2. The selected location's temperature screen will be displayed (see Fig. 23-4.)

If done viewing a location, press **SET** to return to the default screen. OR; with the meat probe plugged in to the receiver, you may follow steps 3-5 to set the meat probe temperature.

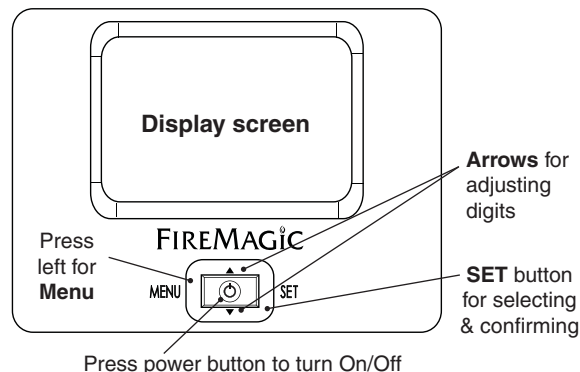

Fig. 23-2 Orientation

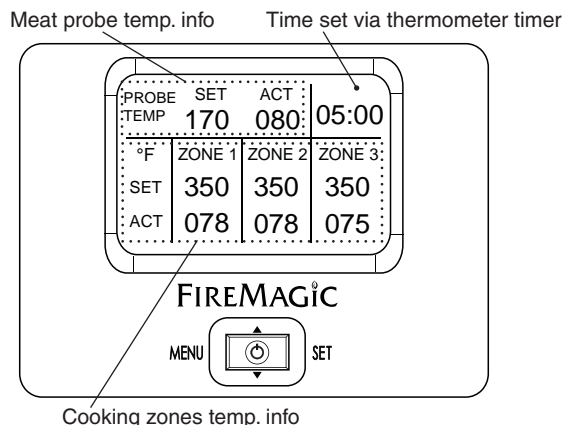
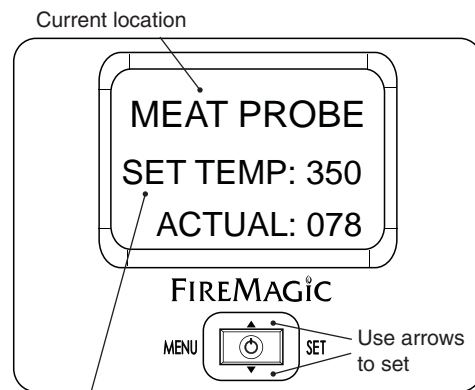

Fig. 23-3 Default screen detail



Set this temp. as desired (meat probe only)

Fig. 23-4 Temp. screen (meat probe shown)

REMOTE RECEIVER (cont.)

- Use the arrows to set the desired temp (see 'Temp Screen' figure on previous page).

Note: **PRESSING** the arrows will adjust the desired temp. by increments of one. **HOLDING** them down (for several seconds) will adjust the temp. rapidly.

- Press **SET** to return to the default screen.
- Put the meat probe into the cooking meat to obtain an actual temp. reading. The alarm sounds when the actual temp. reaches the set temp.

Note: Do not leave the meat probe in the meat for a prolonged period of time, or with the hood closed.

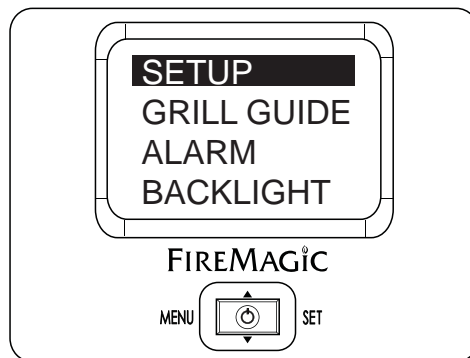

Fig. 24-1 Menu screen

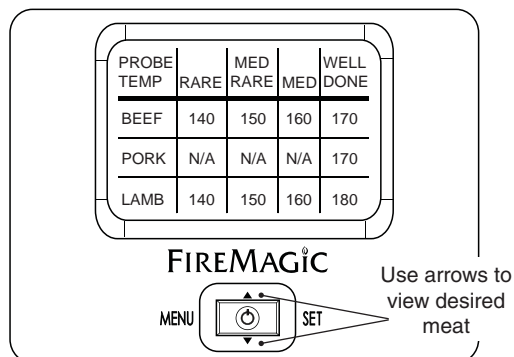
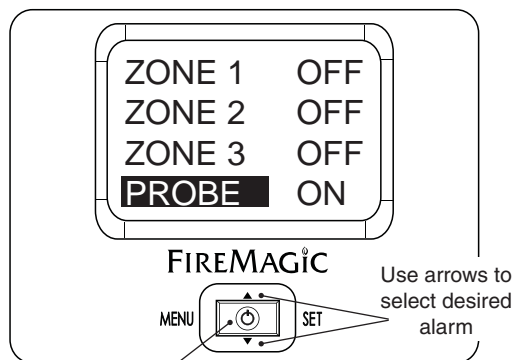
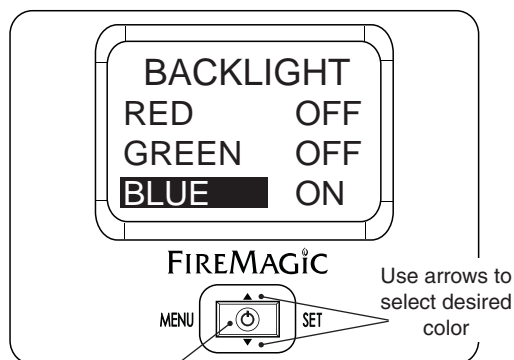

Fig. 24-2 Grill Guide screen



Press power button to turn On/Off

Fig. 24-3 Alarm screen



Press power button to turn On/Off

Fig. 24-4 Backlight screen

Alarm Sounding Info

The alarm on the receiver will sound (if set to do so) when any location reaches its set temperature. The alarm is silenced by pressing the power button. The thermometer alarm will continue to sound (if set to do so) and must be silenced by pressing any button on it. Alternatively; if the thermometer is silenced first, it will stop sending a signal to the receiver, and the receiver will silence.

Should the alarm go off on the thermometer while the receiver is in sleep mode; it will wake the receiver.

MENU SCREEN

Press the power button to turn the receiver On. The default screen will be displayed. Press the **MENU** button to display its screen. Press the up/down arrow to scroll through the options. (See Fig. 24-1.) See below for options under the menu screen.

Note: The menu screen will return back to the default screen after approximately 30 seconds of no activity. Press the **MENU** button to manually return to the default screen.

Sync Receiver with Thermometer

- Under the menu screen select **SETUP**. Press **SET**.
- Use the up/down arrow to select **SYNC**, and press **SET** to sync the receiver.

Note: The thermometer must be on to sync the receiver.

Additional Menu Screen Functions

Please reference the Thermometer section on the previous pages regarding Changing Temperature units / Grill Guide / Setting the Alarm / Setting the Backlight. These options are available in the receiver and are controlled the same as the thermometer.

Exception: For the Alarm and Backlight screens; use the power button to toggle between ON/OFF (as opposed to the light button). See Fig. 24-3 & 4.

Batteries

The receiver is powered by two AAA (alkaline or better) batteries. Using the backlight feature will drain the batteries quicker. If batteries are removed; the receiver will stay synced.

ROTISSERIE INSTRUCTIONS

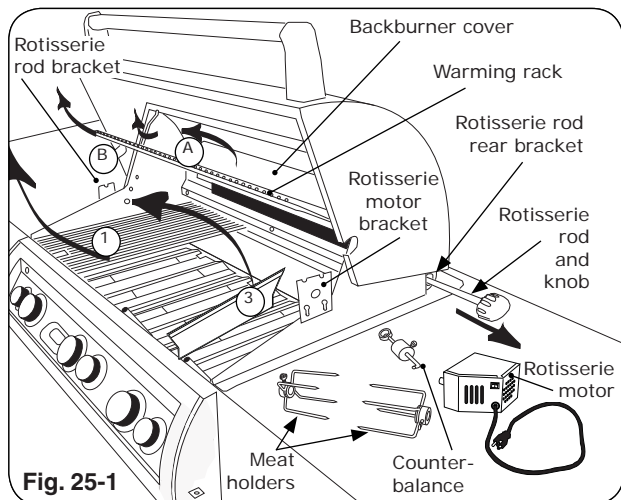

Fig. 25-1

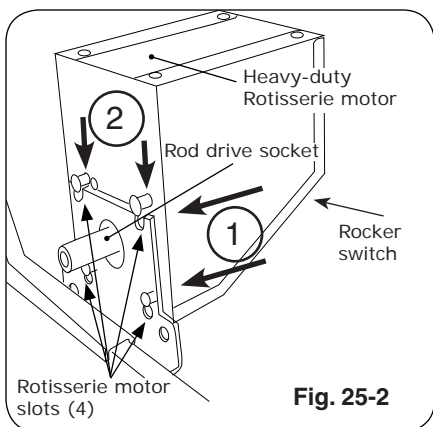

Fig. 25-2

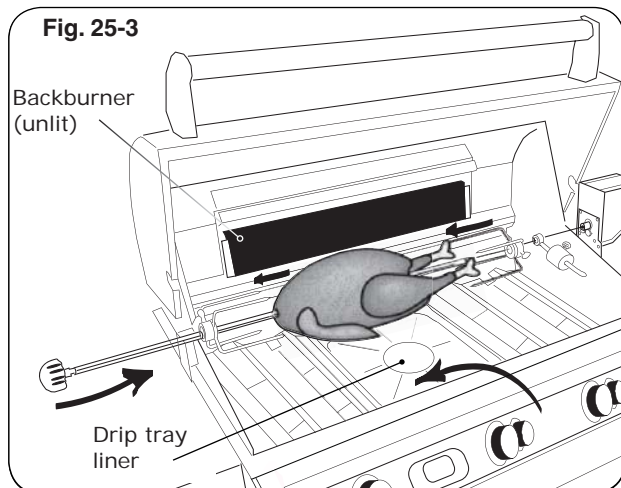

Fig. 25-3

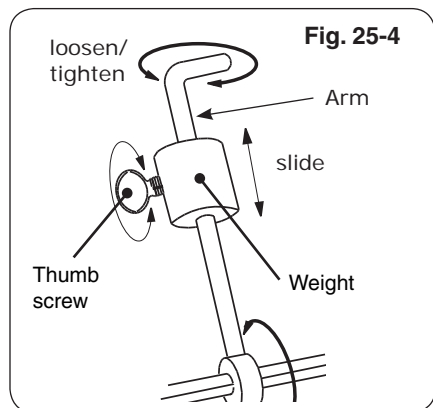

Fig. 25-4

CAUTION: WHEN USING THE BACKBURNER: KEEP THE OVEN LID CLOSED TO PREVENT HEAT LOSS, PROVIDE PROPER CONVECTION, AND PROVIDE PROPER VENTING. THIS WILL ENSURE EVEN COOKING TEMPERATURES.

DO NOT KEEP YOUR OVEN LID OPEN DURING ROTISSING, AS THIS MAY CAUSE PERSONAL INJURY, OR IN SOME CASES, IN WINDY CONDITIONS, DAMAGE TO THE GRILL.

1. Remove warming rack, backburner cover, cooking grids, and zone separators. Leave the flavor grids on if possible.
2. Slide rotisserie motor fully onto motor bracket (right side, Fig. 25-1 and 25-2).
3. Remove rotisserie rod from rear bracket (Fig. 25-1) and attach knob if necessary.
4. Slide the left meat holder onto the rod (and tighten), the meat onto the rod and into the holder, followed by the right meat holder onto the rod and into the meat as shown in Fig. 25-3. Tighten the right meat holder. Be sure the meat is centered and balanced as well as possible.
7. Hold both ends of the rod so it settles freely (do not grip tightly). Allow the rod to rotate until the heavy side of the meat rests downward.
8. The counterbalance may then be attached to even weight distribution. Slide counterbalance onto rod next to the meat holder. Loosen the arm and point it upward opposite the heavy side of the meat. Tighten the arm.
9. Slide the counterbalance weight up or down the arm until the rod rotates most evenly then tighten thumb screw (Fig. 25-4 and Fig. 25-5).
10. Insert the pointed end of the rod into the motor drive socket and the groove next to the knob into the left support bracket.
11. To keep drippings off the burners and simplify cleanup, place Fire Magic® drip tray liners under the meat, if desired (Fig. 25-3).
12. Plug-in the rotisserie motor and press the rocker switch to start (Fig. 25-2).
13. Light backburner per lighting instructions in this manual (or on drip tray handle) and close oven lid.

Important: Turn the backburner to low or off when stopping the rotisserie to prevent overcooking.

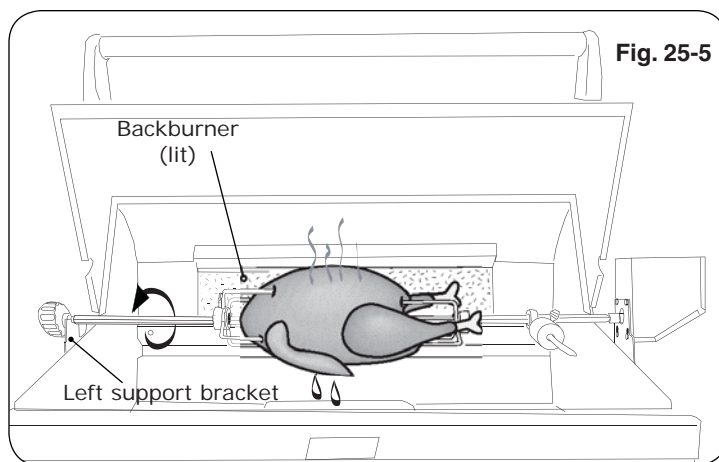

Fig. 25-5

USING THE FOLDING SHELF

DROP-SHELF OPERATION

- A.** To lower the shelf, grasp the middle of the shelf on both sides and lift upward so that the inner lip of the shelf, along the side of the grill, lifts out of the locking slot. Then use the handle to allow the end of the shelf to slowly rotate down as pictured to the right.
- B.** To raise the shelf, perform the opposite of A. above. Grab the shelf by the handle and raise to the horizontal position. Lift slightly upward from the center of the shelf on both sides, allowing the inner lip to drop down into the locking slot and lock the shelf safely into position.

CAUTION: Do **NOT** place fingers near hinge when closing.

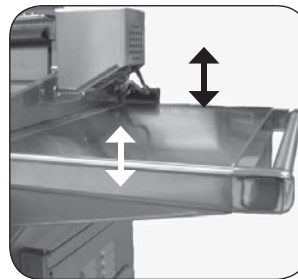

Shelf
up & locked

Being
lowered or
raised



Shelf
down

PAPER TOWEL HOLDER

This Fire Magic® grill comes with a fold-away paper towel holder.

To use the paper towel holder:

1. Make sure the collapsible grill shelf is extended and locked.
2. Grasp the rounded end of the paper towel holder firmly (without compressing it) and pull it away from the side of the grill so that it rotates toward the front of the grill and locks into the extended position.
3. Slide a roll of paper towels over the rounded end of the paper towel holder until the entire roll is on the holder and past the retaining lip.

When not in use, the rack may be folded back out of the way by firmly grasping the rounded end of the holder and rotating it back into position against the wall of the grill.

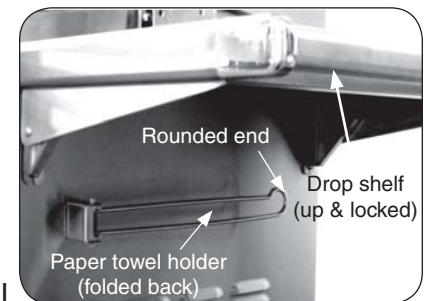

Fig. 26-2

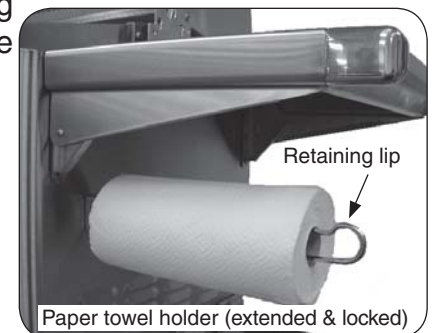

Fig. 26-3

WARNING

Remove paper towels or anything flammable from the holder before folding it back against a hot grill. Placing flammable objects too close to a heat source may cause fire, property damage, or injury.

CAUTION: The paper towel holder must be folded back against the grill before lowering the collapsible shelf (see above). Failure to do so could result in damage to the grill.

REMOVING DRAWERS

To remove a drawer; pull it completely out. Release the drawer from the drawer slides by pressing the black lever down on the right side, and up on the left side.

To re-attach a drawer; extend the drawer slides completely and align the drawer into the slides, pushing the drawer closed. Open the drawer to verify that it has locked in place.

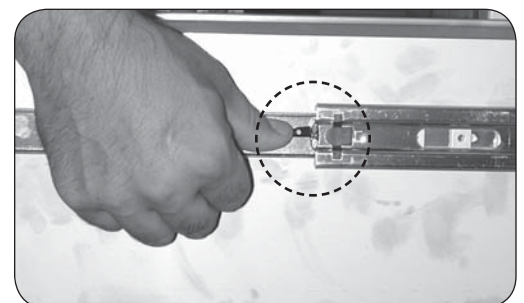

POWER BURNER

POWER BURNER INSTALLATION

1. Place the flame collimator over the burner with the tabs and cutouts resting on the inner shell, as shown in Fig. 27-1. Flex the front of the collimator towards the burner until the cutouts fit down around the collimator support. This will lock your collimator into place. The flame collimator acts as a barrier for windy conditions and creates higher BTU concentration to the support grid.
2. Place the cooking grid and the cover over the power burner.

POWER BURNER SAFETY

The left knob controls the inner burner and the right knob controls the outer burner

CAUTION: THE POWER BURNER IS HOT. DO NOT TOUCH WITH BARE SKIN.

Be sure the power burner has good ventilation and is free of debris and away from flammable substances before lighting.

Properly burning flames are mostly blue and are steady and spread evenly around the burner.

STAINLESS STEEL POWER BURNER COVER

Note: The cover is free-standing and is not hinged in the back.

Use the built-in handle to remove the cover.

ORIFICE INSPECTION, AND REPLACEMENT

1. Remove the cover, cooking grid, and flame collimator. Compress the collimator front to back to release the front lock then rotate up as shown in Fig. 27-1.
2. Lift the back of the power burner up out of the locator hole while moving the two necks of the burner toward the back of the grill, away from their respective gas orifices.

CAUTION: THE POWER BURNER IS HEAVY.

3. Use a $\frac{3}{8}$ " socket driver to reach into the empty burner space from the top and remove each of the two gas orifices protruding from the front fire-wall of the grill in turn. Take care that the springs near the orifice remain attached.

4. Consult Table 1 at the beginning of this document to determine the proper orifice size for each of the inner (right) and outer (left) burners based on the type of gas being used.

WARNING

YOU MUST USE THE SPECIFIED ORIFICE (SEE TABLE 1) FOR THE GRILL TO OPERATE SAFELY AND EFFECTIVELY.

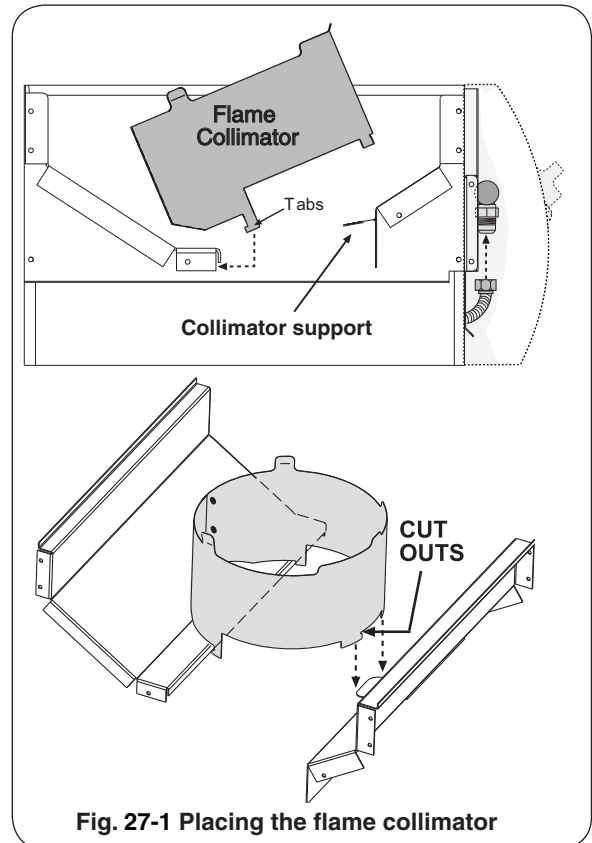

Fig. 27-1 Placing the flame collimator

WOK COOKING

When using a wok for stir fry or other cooking, remove the cooking grid and place the wok directly on top of the collimator.

CAUTION: A wok has a rounded bottom and may slide on the collimator, causing hot liquid to spill out of it.



Fig. 27-2

OPTIONAL INFRARED BURNER OPERATION

The infrared (IR) searing burner (optional) cooks with a powerful radiant heat.

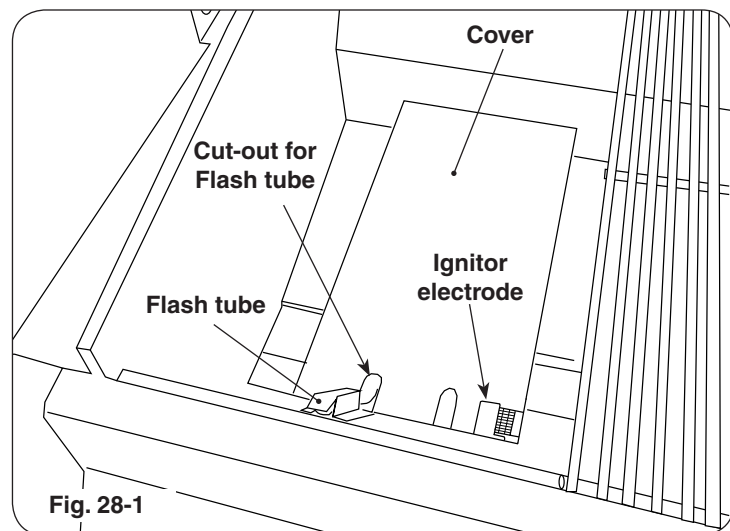

Fig. 28-1

Light the infrared burner following the LIGHTING INSTRUCTIONS in this manual or printed on the drip tray. Follow these guidelines when operating the Infrared burner:

- **DO NOT place food on the cooking grid until the IR burner glows orange (Fig. 28-3).** Drippings are heated and evaporate instead of sticking to and impairing burner function.
- **For cleaning purposes; always leave your burner on (after cooking) for an additional 5 minutes, to allow for a burnoff period. This is important to keep your burner clean and operating properly. As the burner is self cleaning (at full temperature); avoid the use of cleaners or abrasives.**
- When not in use, **always** cover the infrared burner with the stainless-steel cover. This protects the burner from drippings (from other cooking), airborne particles, and foreign objects (Fig. 28-2).
- Do not strike or scratch the burner ceramic as it may chip, crack, or break (Fig. 28-2).

Note: Digital thermometer does not give accurate readings for infrared burners.

Important: When grilling with the infrared burner, always place a cooking grid above it. The cooking grid must be removed for rotisserie cooking.

CAUTION: Never attempt to operate the IR burner with the protective cover in place.

WARNING

Only handle the infrared burner cover when the grill is cold or with a well-insulated long-handled tool or heat resistant gloves.

SIDE VIEW (with cover on)

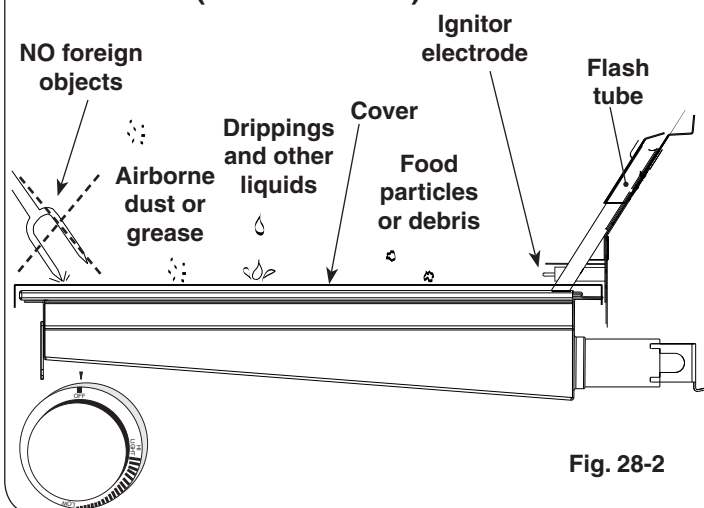

Fig. 28-2

Burner ceramic must be protected with cover when burner is not in use.

SIDE VIEW (burner on HI LIGHT and glowing orange)

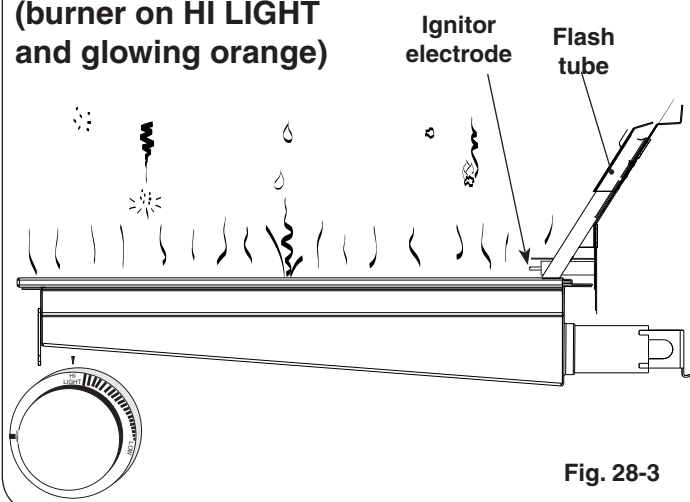

Fig. 28-3

Drips and particles evaporate before hitting infrared burner when cooking at the maximum setting.

GRILLING TIPS

The art of grilling involves learning the nuances of your grill and knowing how various cuts of meat and other foods cook on it under different settings and conditions.

Each grill will be unique due to its configuration and how it is positioned or installed. This section contains information about how Fire Magic grills were engineered, which will help you in learning how your grill responds to the way you use it.

COOKING ZONES

Your grill is divided into three cooking zones, each corresponding to a burner. Burners are numbered starting at one (1) on the left, going to three (3) on the right (see Fig. 29-1). The cooking zones are monitored by the digital thermometer.

Note: E1060 models contain an additional cooking zone, on the far left of the grill. This zone is not monitored by the digital thermometer.

Each cooking zone temperature is designed to be controlled individually by the burner control knob.

Specific zones are better suited to specific types of cooking because of features such as being adjacent to a fire wall or away from the smoker drawer.

GRILL HEAT DISTRIBUTION - MAIN BURNERS

The heat level at each part of the grill has been engineered for specific purposes. Knowing the heat distribution for each burner will allow you the best possible food positioning when grilling.

CAUTION: Even the coolest part of the grill is too hot to be touched during operation of the grill.

The front of the grill is designed, for safety reasons, to be the coolest part of the grill. If you look directly down on the grill top, while it is off and cool, you can see this portion of the grill, where the front end of each burner stops and the slope of the inner grill fire wall begins. This area also loses heat most rapidly when the oven lid is opened (see Fig. 29-2).

From the front of the grill moving toward the back, the heat rises gradually until just above the burner's

front edge, where it rises rapidly to a fairly even temperature reflected by the digital thermometer. The heat continues to rise gradually until it reaches a maximum directly above the place where the two lobes of each burner connect (see Fig. 29-2). From there to the back of the grill, heat diminishes moderately. This supports the desired temperature for the warming rack and prevents heat from becoming excessive at the back fire wall of the grill.

GRILL HEAT DISTRIBUTION - IR BURNER

Infrared burners are designed for even, searing heat across their whole surface. Because the heat is radiant, it tends to heat the food you are cooking directly without heating the air around it as much as a conventional burner.

SMOKER DRAWER USE

When using a single cooking zone with the smoker drawer, use zone 1. It will minimize burner heat on the flavor drawer and maximize a circulating convection current that will draw the smoke flavor into the food.

WIND CONSIDERATIONS

Wind direction can have an effect on the grill, especially with the oven open. For maximum stability and convenience, position the grill so that the oven opens toward any prevailing wind (Fig. 29-1).

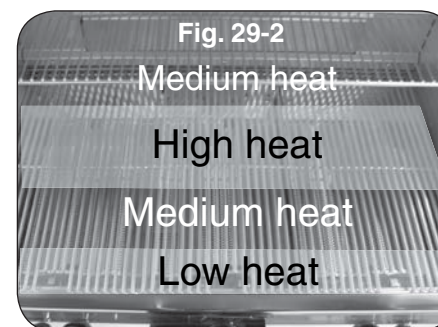
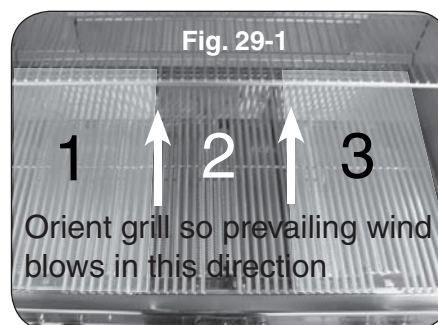

THE GRILL BRUSH (OPTIONAL)

Purchase a Fire Magic® stainless-steel grill brush (sold separately) to keep your grill cleaner. It comes with scraper for large particles and a replaceable head with brass bristles for overall cleaning.



Grill brush with replacement head

THE WARMING RACK

The warming rack (Fig. 30-2) is packed separately.

To install the warming rack, lift the front of the rack up slightly and insert the rack hangers into the two holes in the back of the inner oven hood just above the backburner. Then lower the front of the rack into a level position to lock the rack in place.

To remove the warming rack, lift up on the front of the rack until the rack hangers pull free from their supporting holes.

Note: Removing the warming rack before using the rotisserie will leave more clearance for the meat being cooked.



Fig. 30-2 Warming rack in place inside oven

THE COOKING GRID LIFTER

Hold the grid lifter by gripping the center section with the prongs pointing down (use an oven mitt or heavy glove if the grill is hot). Insert the notched end of the grid lifter into the cooking grid, in front of the midway point (front to back; Fig. 30-3), and central (left to right; Fig. 30-4). Twist the grill lifter (clockwise or counterclockwise) so the handle is parallel to the grill rods. This “seats” the spiked end of the grid lifter between two rods, enabling you to safely lift out the grid. Lift slowly and adjust the grid lifter, if necessary, for balance.

THE DRIP TRAY

The drip collection system allows you to brush or scrape excess dried residue from the grilling area directly into the drip tray (see PARTS LIST for drip tray location).

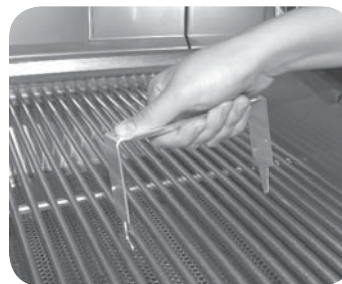

Fig. 30-3

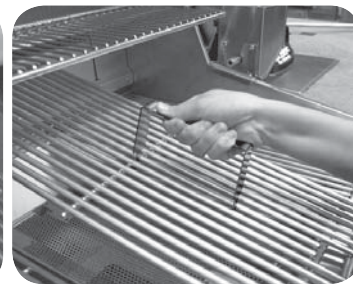

Fig. 30-4

Placement of the grid lifter in cooking grid

THE FLAVOR GRID(S)

Place each flavor grid directly over a burner. The solid areas of the grid should rest over the tabs found on the burner. See Fig. 30-6.

Note: This allows heat from the burners to be evenly distributed throughout the cooking area. The flavor grids heat and cool quickly, making the grill very responsive to changes in heat from the burners.



Fig. 30-5

Wood chip smoker drawer

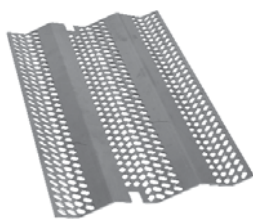

Fig. 30-6

Flavor grid

FLAVOR FROM WOOD CHIPS OR CHARCOAL

You can add wood chips, wood chunks, or the natural wood charcoal of your choice to the smoker drawer (Fig. 30-5) or the flavor grid (Fig. 30-6). Heat wood chips in the smoker drawer by lighting the smoker burner using the smoker control and zone 2 ignitor. When using the flavor grid, we recommend placing wood outside the direct cooking zone or wrapping it in perforated aluminum foil. Soaking wood before use will slow burning and increase smoke flavor. Wood and charcoal ash will remain in the flavor grid and drawer after use. Either can be easily removed and cleaned when unit has fully cooled. The smoker drawer is water-tight, allowing liquid flavorings to be added as well.



Fig. 31-2

Pull out the drip tray and place liner

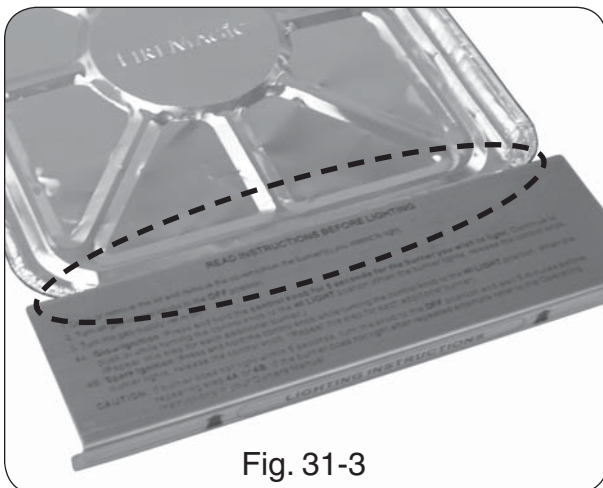

Fig. 31-3

Be sure liner fits under lighting instruction plate

Drippings from grilling flow through specially designed channels and collect in the drip tray. Check the drip tray regularly and empty when required.

Fig. 31-1



Your grill includes a pack of four (4) Fire Magic® drip tray liners (Fig. 31-1). For your convenience in cleanup, place a liner into the drip tray before grilling.

To fit a liner into the drip tray, pull out the tray and set it on a flat, level surface. Place the liner in the drip tray as shown in Fig. 31-2 and carefully insert the tray back under the control panel.

Note: Be sure that the liner is properly placed into the the drip tray. The front of the liner must fit under the drip tray's lighting instruction plate (see 31-3 detail).

After each use, wait for the grill to cool and carefully pull out the drip tray to check it. When a liner is nearing full, carefully lift it out of the drip tray, lifting with both hands to keep the tray level until it is safely discarded. Then insert a new drip tray liner.

Order more drip tray liners through your local Fire Magic® dealer.

Note: The foil tray liner is also useful for setting on burners to cover them and catch drippings directly during rotisserie only cooking.

Note: There are easy to follow lighting instructions etched onto the top of the drip tray handle.

REPLACING HALOGEN BULBS

Fire Magic® Echelon grills are all engineered with the conveniences of electrical power for illuminating and igniting the grill.

To replace any Echelon oven light, follow the instructions below.

Important: ONLY REPLACE WITH 12V / 10 WATT HALOGEN BULB(S).

WARNING

To protect from potentially sharp sheet metal and glass, wear gloves and safety glasses during this procedure.

1. Turn all burner control knobs to the **OFF** position and shut off the gas supply to the grill at the source (tank valve for propane units or gas line shut-off valve for natural gas units.)
2. Disconnect supply of external electrical power to the grill.

CAUTION: Wait for the grill, oven, lens, light bulb, and fixture to cool before proceeding to the next step.

3. Open the oven lid.

Important: Place one hand directly below the glass lens and prepare to catch it when it is detached.

4. Carefully insert a standard flat head screwdriver or thin plastic spatula between the glass lens and the stainless steel on which the light is mounted and gently pry the glass lens out in such a way

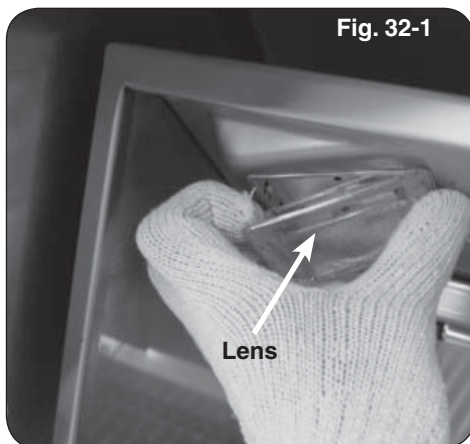

that the stainless steel is not scratched (twisting the screwdriver handle, for instance). Catch the lens and set it safely aside.

Note: You may wish to take this opportunity to clean the lens with a standard household window cleaner and then dry it completely.

5. Wearing a pair of gloves, reach into the fixture, gently grab the bulb, and pull it straight out of the fixture so that the two pins at the base of the bulb come all the way out.

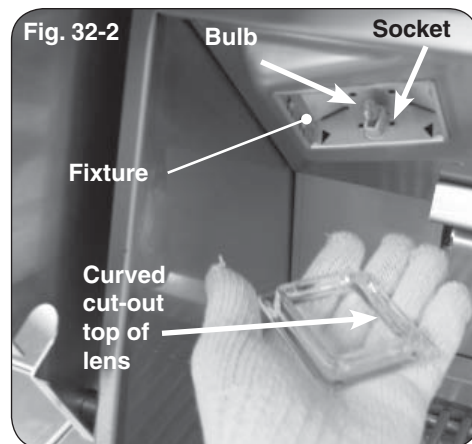

Important: Bulb is halogen. DO NOT TOUCH with bare hands. Oils from hands drastically reduce bulb life.

Note: It may be helpful to rock the bulb gently backward and forward while pulling it out.

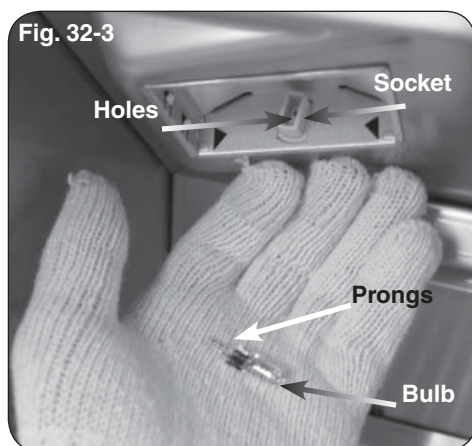

6. Inspect the old bulb for broken glass or filament.

Note: It may be beneficial to test a suspect bulb in one of the other light fixtures known to be working and turn the power back on to be certain the bulb is actually not working.

7. Insert the new **12V / 10 watt** halogen bulb into the socket so that both pins slide all the way into the two holes in the bottom of the socket.
8. Place the lens back into the fixture opening with the curved cut-out on the bottom and snap it back into place.

POWER SUPPLY FUSE REPLACEMENT

Fig. 33-1



Remove 6 large screws

Disconnect
here

Fig. 33-2

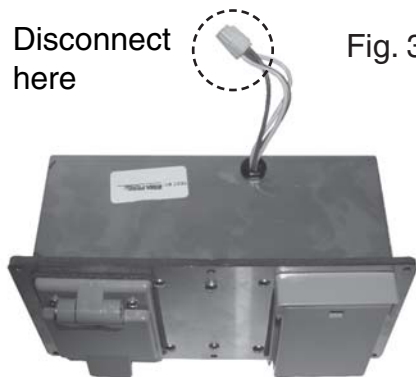

Slightly pull out box and disconnect wire harness

Fig. 33-3



Remove 4 small screws

Fig. 33-4

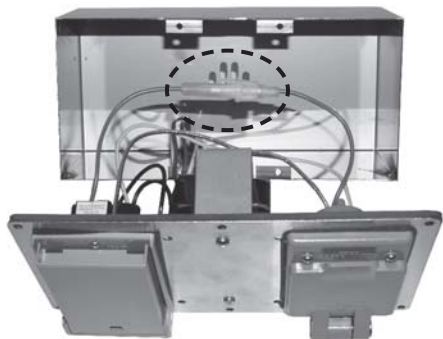

Carefully open box and replace fuse (red wire)

1. The power supply box is located on the right side of the grill (reference the PARTS LIST).
 2. Using a phillips screwdriver, remove the 6 large screws found on the cover of the power supply box (see Fig. 33-1).
 3. Slightly pull out the box to expose the wiring, and disconnect the wire harness (see Fig. 33-2). Completely remove the box from the grill for ease of fuse replacement.
 4. Remove the 4 small screws found on the cover of the power supply box (see Fig. 33-3).
- Note:** The 2 center screws do not need to be removed.
5. Carefully open the box by pulling its cover away. You may need to feed the wire harness into the box to provide enough slack to open on the other end. Then “push in and twist” the fuse holder (red wire), exposing the fuse. See Fig. 33-4.
 6. Replace the fuse accordingly (3AG 2 AMP).

CARE & CLEANING

APPLIANCE MUST BE COMPLETELY COOL WHEN CLEANING. DO NOT SPRAY ANY CLEANER OR LIQUIDS ON THE APPLIANCE WHEN HOT.

The appliance *must* be cleaned as often as once a month (depending on use) to prevent grease build-up and other food deposits.

INTERIOR

THE BURNER PORTS AND CARRY-OVER SLOTS MUST BE KEPT CLEAN TO ENSURE PROPER IGNITION AND OPERATION.

Remove the burner (see orifice changing instructions) and clean the ports and slots as required. (For Fire Magic grills use Maintenance Kit part #MK-1.) Also inspect and clean the burner inlet for insects and nests. A clogged burner can lead to a fire in the bottom of the appliance.

The inside of the appliance may be cleaned periodically with oven cleaner if desired. Follow the oven cleaner instructions for proper use.

Be careful not to get oven cleaner on the outside surface of the appliance as it can permanently damage the finish.

EXTERIOR

Stainless steel surfaces when exposed to temperatures produced by the grilling process will change color. The stainless steel will change color from silver to brown and blue. This can be removed by using stainless steel cleaner.

Clean your appliance by first using grill cleaner to remove grease and dirt. Always wipe with the grain (See Fig. 34-1). Next, use stainless steel cleaner to restore the stainless steel color (Note: not for mirror finish). Finish by wiping your appliance down using polish wipes. **To clean the mirror panel (if applicable), use a quality brand glass cleaner only, not any of the cleaners mentioned above.**

If your appliance is installed in a seaside (salt air) or poolside (chlorine) location, it will be more susceptible to corrosion and must be maintained/cleaned more frequently. Do not store chemicals (such as chlorine or fertilizer) near your stainless steel appliance.

Due to the nature of stainless steel, surface iron oxide deposits may appear. Do not be alarmed – these deposits are removable with stainless steel cleaner through prompt and periodic maintenance. If not attended to promptly, permanent pitting may occur.

By following these recommendations, you will enjoy the beauty and convenience of your appliance for many years to come.



Fig. 34-1 - Wipe with grain

PROTECTING YOUR APPLIANCE FROM THE WEATHER

An optional heavy-duty cover will protect your appliance's finish and protect your investment. The water repellent cover will protect your appliance from the weather. Always cover your appliance when not in use. (Allow to cool before covering.)

Please specify the model number and serial number of your appliance when ordering a cover.

IMPORTANT

IN THE EVENT OF A GREASE FIRE, IMMEDIATELY SHUT OFF THE MAIN GAS VALVE TO THE GRILL. KEEP THE LID OPEN AND ALLOW THE FIRE TO EXTINGUISH ITSELF. A THOROUGH INSPECTION BY A TRAINED SERVICE TECHNICIAN SHOULD BE CONDUCTED BEFORE FUTURE USE OF YOUR GRILL. THE SERVICE TECHNICIAN WILL CHECK THE SYSTEM FOR GAS LEAKS AND WILL CHECK ALL ELECTRICAL WIRING FOR DAMAGE. ALL GAS LEAKS AND WIRING MUST BE REPAIRED PRIOR TO FUTURE USE.

TROUBLESHOOTING

If you have trouble with this Fire Magic® grill, please use this list to identify the problem. By trying one or more of the solutions to the possible cause, you should be able to solve the problem. If this list does not cover your present problem, or if you have other technical difficulties with the grill, please contact your local Fire Magic® dealer or visit our web site at www.rhpeter.com.

PROBLEM	POSSIBLE CAUSE	CORRECTION
Accessories do not operate	<ol style="list-style-type: none"> 1. Power source not hooked to power supply 2. Master switch is off 	<ol style="list-style-type: none"> 1. Hook external power to grill. 2. Turn master switch on.
Ignition system failure	<ol style="list-style-type: none"> 1. Power source not hooked to power supply 2. Improper air shutter adjustment 3. Ignition wire disconnected 4. Low gas pressure 5. Front carry-over port 6. Blown fuse in power supply box 7. Igniter switch malfunction 	<ol style="list-style-type: none"> 1. Hook external power to grill. 2. Adjust air shutters. 3. Plug wires back into ignition switches. 4. Have the gas co. check pressure at grill. 5. Clean burner ports. 6. Replace the fuse. Reference the POWER SUPPLY FUSE REPLACEMENT section. 7. Contact dealer for replacement.
Insufficient heat	<ol style="list-style-type: none"> 1. Improper air shutter adjustment 2. Using propane orifice for natural gas 3. Low gas pressure/flame (propane) 4. Low gas pressure/flame (natural) 	<ol style="list-style-type: none"> 1. Adjust air shutters. 2. Check/change orifices. 3. Shut off all valves, including propane tank, and follow lighting instructions exactly. (See important note* below.) 4. Have the gas co. check pressure at grill.
Uneven heating	<ol style="list-style-type: none"> 1. Burner ports partially blocked by debris 2. Small spiders or insects in burner 3. Improper air shutter adjustment 	<ol style="list-style-type: none"> 1. Remove burners and clean out ports. 2. Inspect burners and orifices for spider webs or other debris that may block flow. 3. Adjust air shutter.
Thermometer not operating properly	<ol style="list-style-type: none"> 1. Thermometer malfunction 	<ol style="list-style-type: none"> 1. Reset thermometer by turning master switch off then back on.
Interior & knob light(s) not operating	<ol style="list-style-type: none"> 1. Thermometer light switch not functioning 2. Interior or knob light(s) burned out 	<ol style="list-style-type: none"> 1. Reset thermometer by turning master switch off then back on. 2. Contact dealer for replacement.
Burner goes out on LOW	<ol style="list-style-type: none"> 1. Valve "Low" setting needs adjustment 	<ol style="list-style-type: none"> 1. Light burner on HIGH, immediately turn to LOW setting. Remove knob from valve and using a small flat screwdriver, slowly turn the adjustment screw in the stem, a little at a time (30° to 45°), in either direction, until the flame is approximately 1/4" in height from burner ports.
Rotisserie noisy	<ol style="list-style-type: none"> 1. Rotisserie out of balance 	<ol style="list-style-type: none"> 1. Adjust rotisserie counterbalance.
Rotisserie doesn't turn but lights work	<ol style="list-style-type: none"> 1. Elec. socket circuit breaker is tripped 	<ol style="list-style-type: none"> 1. Reset circuit breaker (See Fig. 35-1).

To reset the cart electrical outlets press in hard on the reset (upper) button until you hear an audible click.

Note: The main power feed to the cart must be on for the reset switch to function. Open the grill oven lid and turn on the lights to verify that the grill has electrical power before resetting the breaker.



*** Important:** Propane tanks are equipped with a safety shutdown device that may cause low or no gas/flame at the burners if operating and lighting instructions are not followed exactly. If you suspect the propane tank safety shutoff is in effect, shut off all burner control valves and the propane tank valve. Then read and follow the LIGHTING INSTRUCTIONS exactly. Lighting instructions are located in your owner's manual and printed on the grill's metal drip tray. If the problem persists, continue troubleshooting, or contact your local dealer or R. H. Peterson for assistance.

CONVERTING THE GAS TYPE

REGULATOR CONVERSION

The gas regulator, located behind the control panel, must be set for the type of gas used to fuel the grill. To check the regulator setting, remove the cap in the center of the regulator (Fig. 36-1). Holding the cap vertical (see Fig. 36-2), the letters at the bottom of the plastic stalk indicate the gas type for which the regulator is currently configured. If the bottom of the regulator stalk does not indicate the gas connected to the grill, remove the stalk from the cap, invert, and replace into center of cap. Replace cap on the regulator, screwing down until snug.

Gas regulator

Note the cap on top.

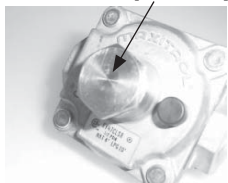

Fig. 36-1



Read gas type here. (LP shown)
Fig. 36-2

GAS ORIFICE CONVERSION

This Fire Magic® grill comes from the factory configured for one type of gas as marked on the label behind the control panel. When the grill is converted, this label must be replaced or updated to identify the new gas.

Each burner has a brass orifice, which can be replaced and must match the gas being used. When converting the grill to a different gas, each burner's orifice must be replaced with the corresponding orifice for the new gas.

Natural-gas to propane-gas conversions using a tank internal to a portable grill require installation of a propane tank holder (not included) for safety and compliance with the ANSI standards referenced on the cover of this document. This tank holder must be purchased separately from the manufacturer.

Consult Table 1 at the beginning of this document to determine the proper orifice sizes for each burner.

It is critical to the operation of each burner that its orifice be fully inserted into the center of its orifice opening.

WARNING

Hazardous overheating will occur if a natural-gas orifice is used with propane gas.

CAUTION: Make sure the grill is at a safe temperature and isolated from gas and electrical supplies before beginning.

For your safety, exercise caution, and make sure you have adequate hand protection, such as gloves, when handling metal parts.

Required tools:

- Phillips-head screwdriver (#2 medium)
- Needle-nose pliers
- $\frac{3}{8}$ " hex nut driver (deep socket)
- $\frac{5}{16}$ " hex nut driver

CHANGING THE MAIN BURNER ORIFICES

1. Remove the cooking grid from above the burner you are working on by lifting it first from the front and set it aside.
2. Remove the flavor grid from above the burner you are working on and set it aside.
3. Remove the cotter pin from the left or right rear burner anchoring peg by pulling it straight out of the cotter pin hole using fingers or needle-nose pliers (Fig. 36-3).

CAUTION: The burner is heavy.

4. Lift the back end of the burner out of the anchor peg holes, then move the burner toward the back of the grill to clear the gas inlet and set it aside.
5. Use a $\frac{3}{8}$ " hex nut driver to remove the exposed orifice (Fig. 36-4) and replace it with the correct orifice for the new gas. (See Table 1 at the beginning of this document for orifice sizes.)
6. Replace the burner by first sliding the open cylindrical end of the burner around the orifice, enveloping it and centering on it, then lower the back end anchor pegs into the anchor peg holes.

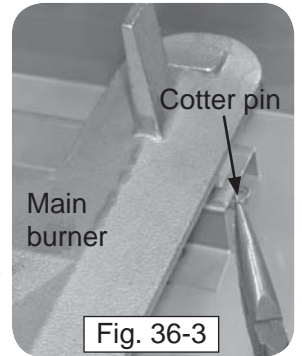

Fig. 36-3

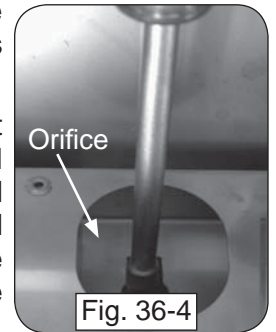

Fig. 36-4

Note: It is critical to the continued safe functioning of the burner that the orifice is centered and completely inside the burner gas conduit.

7. Reinsert the cotter pin into the right rear burner anchor peg using fingers or needle-nose pliers.
8. Replace the flavor grid and then the cooking grid so that the cutout section of the cooking grid is lined up with the lighting tube.

Repeat these steps for each main burner.

CHANGING THE BACKBURNER ORIFICE (IF EQUIPPED)

1. Remove the warming rack if installed and set it aside.
2. Remove the backburner cover.
3. Unscrew all backburner access plate screws using a Phillips-head screwdriver and set them aside.

CONVERTING THE GAS TYPE

4. Remove the back panel by pulling the bottom toward the front of the grill and rotating it upward and outward until the two top tabs attached to back wall of the oven can be removed from the slots in the top of the plate.
5. Remove the backburner retaining screw on the lower left of the backburner using a Phillips-head screwdriver and set it aside.
6. Pull the wire from the ignitor electrode (Fig. 37-2), then remove the backburner retaining screw on the left of the backburner (Fig. 37-1) using a Phillips screwdriver.

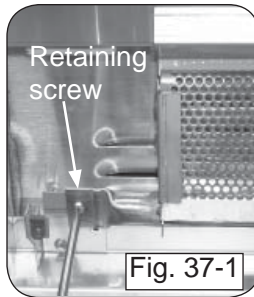

CAUTION: Be careful not to damage the wires connected to the backburner assembly.

7. Use a $\frac{3}{8}$ " hex nut driver to remove the exposed orifice and replace it with the correct orifice for the gas being converted to (See Table 1 for size).
8. Replace the backburner assembly and reinsert the retaining screw. Center the backburner assembly so that the backburner plate will fit over it. Tighten the retaining screw using a Phillips-head screwdriver.
9. Replace the back panel by first inserting the tabs above into the slots in the top of the plate and then rotating the bottom downward and inward.
10. Replace all the backburner plate screws using a Phillips-head screwdriver.

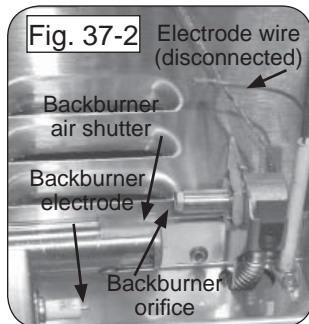

CHANGING THE SINGLE SIDEBURNER ORIFICE

1. Lift the sideburner lid. Then remove the grill and sideburner cap and set them aside.
2. Locate and remove the cotter pin from the sideburner assembly underneath the sideburner shelf using needle-nose pliers. Set it aside.
3. From the top of the sideburner shelf, lift the sideburner upward while rotating the attached tubing underneath away from the orifice near the cart wall. Set it aside.
4. Use the nut driver to remove the exposed orifice and replace it with the correct orifice for the gas being converted to. (See Table 1 for correct orifice sizes based on burner type and gas type.)

Note: To protect the manifold threads when placing the new orifice, start the threading manually, and then tighten with the nut driver.

5. Rotate the burner assembly back into place over the orifice and firmly seated in the shelf.
6. Reinsert the cotter pin underneath the sideburner assembly using needle-nose pliers. It may be necessary to push downward on the burner assembly from above to fully expose the cotter pin hole. Rotate the inserted cotter pin so that it is flush with the underside of the shelf.
7. Replace the burner cap by centering it on the sideburner assembly and making sure it drops in place.
8. Replace the grill with the grating running front to back so that it drops fully down onto the shelf, allowing the lid to close completely over it.

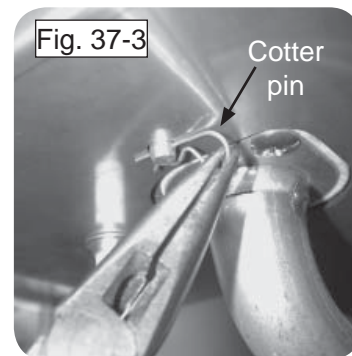

CHANGING AN INFRARED BURNER ORIFICE (IF EQUIPPED)

1. Remove the cooking grid from above the burner on which you are working by lifting it first from the front and set it aside.
2. Unscrew both lighting tube hex head screws with a $\frac{3}{8}$ " hex nut driver.
3. Remove the infrared burner by lifting the back of the burner up so that both tabs are freed from their slots, then lift the burner toward the back of the fire box and upward. Set the burner aside.
4. Use a $\frac{3}{8}$ " hex nut driver to remove the exposed orifice and replace it with the proper orifice for the new gas (see Table 1 for sizing).
5. Replace the infrared burner by first sliding it over the orifice, then lowering the two tabs under the back of the burner into the slots in the back burner rest.
6. Reattach the lighting tube and replace the grid so that the cut-out section is in front.

CONVERTING THE GAS TYPE

CHANGING A SMOKER BURNER ORIFICE →

1. Turn off the gas shutoff valve.
2. Pull off the control knobs. Slowly lift away the lighted bezels to clear the valve stems, and carefully disconnect the wires found on the back of the bezels (use your fingernail.) Remove the woodchip box. Unscrew and remove the control panel screws and washers.
3. Lift the control panel up and outward, allowing it to rest on the internal chain(s).
4. Use a $\frac{5}{8}$ " open end wrench to remove the flex connector attached to the elbow coming out of the smoker burner tube (see Fig. 38-1 and 38-2).



5. Use a $\frac{1}{4}$ " hex nut driver to remove the two hex screws surrounding the elbow (see Fig. 38-2).

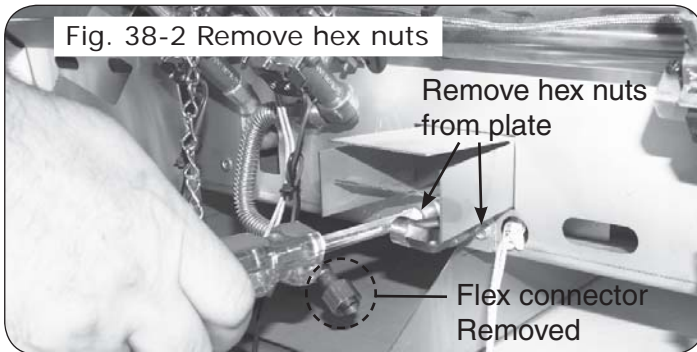

6. Carefully pull out the elbow. It will have the smoker orifice attached to it. Remove the orifice using a $\frac{7}{16}$ " open end wrench and replace it with the correct orifice for the gas being converted to (See Table 1 for size). See Fig. 38-3 for a complete orientation of the smoker assembly, shown outside of the grill for clarity.
7. Once the new smoker orifice is installed onto the existing elbow, reinstall the elbow and orifice into the grill, being sure the orifice properly fits into the smoker burner pipe. See Fig. 38-3 for detail.
8. Refasten the elbow using the two hex nuts.

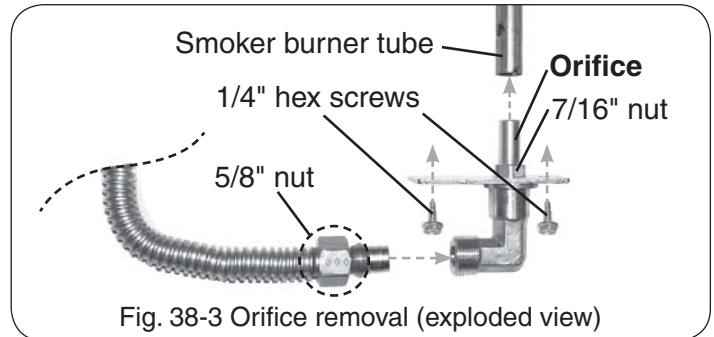

9. Reconnect the flex connector to the elbow.
10. Reinstall the control panel, woodchip box, bezels, and control knobs.

Important: When re-installing the control panel, set it back over the front lip of the grill so that the lid-closed-sensor plunger protrudes through the hole on the upper right of the control panel. Prior to opening the gas shutoff valve, be sure the control knobs are in the OFF position.

BURNER AIR SHUTTER ADJUSTMENT

AIR SHUTTER ADJUSTMENT

Important: Air shutters are preset at the factory based on the gas the grill is built to burn. However, altitude or other local conditions may require air shutter adjustment for proper combustion.

MAIN BURNER

Flames from a properly adjusted main burner with no wind or breeze present will appear fairly steady, consistent, and mostly blue. If the tip of a flame were to turn orange, it should only do so briefly and then become blue again. The flames will appear to burn while touching the burner ports (see Figure 39-1).

If the flames have orange in them and appear to undulate slowly from side to side, or if some of them appear to lift off the burner instead of touching it, then adjust the air shutter, as instructed below.

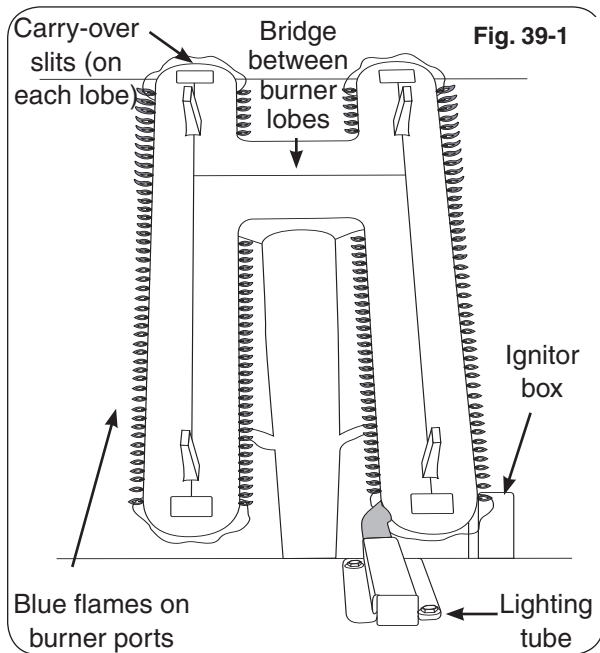

CAUTION: Turn all burner control knobs to the **OFF** position and turn off the gas supply at the source before removing or adjusting a burner.

WARNING

Wait for the burner to be cool or use heavily insulated heat-resistant gloves when handling the burner.

1. Follow the safety precautions and steps for main burner removal in the **CHANGING THE MAIN BURNER ORIFICES** section (steps 1-4).

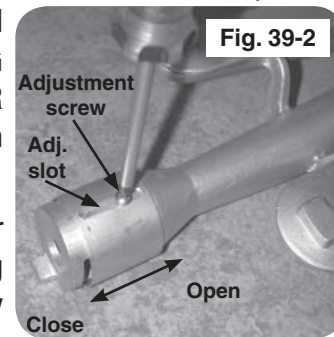

2. Adjust the air shutter opening by loosening the adjustment screw with a screwdriver, then sliding the air shutter backward or forward to open or close the air shutter opening (see Fig. 39-2).

Shutter Setting	Flame Condition
Open too far	Flames shorten and lift off the burner
Ideal setting	Blue flames just touching burner
Closed too far	“Lazy” flames with orange in them

Too large an air shutter opening will allow too much air into the burner, which will cause the flames first to shorten and then to appear to lift up off the ports. For the bottom of the flames to move closer to the ports, close the air shutter more.

If the air shutter opening is too small or closed, the flames will present consistently orange tips and become “lazy,” slowly undulating back and forth.

For propane gas, ideal settings tend to be just slightly open. For natural gas, which generally requires less primary air than propane, the main burner air shutter may be nearly closed.

3. Adjust the air shutter opening and then replace the burner (steps 6-8 in the **CHANGING THE MAIN BURNER ORIFICES** section)
4. Follow the lighting instructions in this manual to light the burner.
5. Repeat steps 1-4 until the flames appear to touch the burner ports, burning fairly steadily and mostly blue (see Fig. 39-1).

BURNER AIR SHUTTER ADJUSTMENT (Continued)

BACKBURNER (IF EQUIPPED)

The air shutter is set at the factory. However, altitude or other local conditions may require air shutter adjustment for proper combustion.

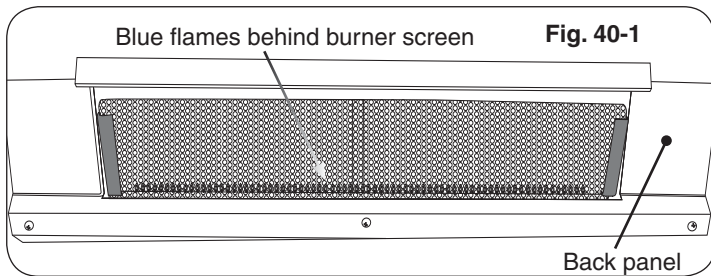

Flames from a properly adjusted backburner will appear as a horizontal line of even blue flames along the bottom of and behind the backburner grating. The grating itself will glow red after it heats up.

Note: It is normal for the backburner to smoke when it is first used. Burning the backburner on **HI LIGHT** for approximately 15 minutes will eliminate the smoking.

If, instead of being blue and even, the backburner flames appear to have orange in them and waver slowly left and right, or if the flames appear to lift off the burner, adjust the backburner air shutter by following the steps below.

The backburner air shutter adjustment is located behind the right side of the access panel in the back of the oven, above the cooking grid.

Note: It is only necessary to remove the backburner back panel, not the backburner, when adjusting the backburner air shutter.

1. Follow the safety precautions and steps for backburner back panel removal (steps 1-4) in the CHANGING THE BACKBURNER ORIFICE section.

CAUTION: The backburner air shutter can be safely adjusted with the backburner lit if it is adjusted using a long-handled screwdriver or well-insulated fire and heat-resistant gloves.

2. Adjust the air-shutter opening by loosening the adjustment screw with a screwdriver, then sliding the air shutter backward or forward to open or close the air shutter opening (see Fig 40-2). Watch the backburner flames while adjusting the air shutter.

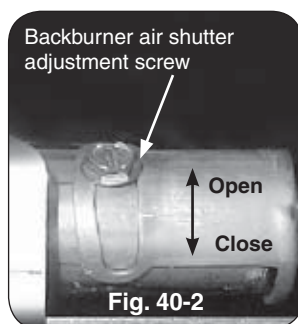

Too large an air shutter opening will allow too much air into the burner, which will cause the flames first to shorten and then to appear to lift up off the ports. For the bottom of the flames to move closer to the ports, close the air shutter more.

If the air shutter opening is too small or closed, the flames will present consistently orange tips and become "lazy," slowly wavering left and right.

3. Continue adjustment until the flames appear to touch the burner ports, burning fairly steadily, consistently, and mostly blue (see Fig. 40-1), then retighten the backburner air shutter adjustment screw.
4. Replace the burner access plate (step 8 in the CHANGING THE BACKBURNER ORIFICE section).

SINGLE SIDEBURNER

The air shutter is set at the factory. However, altitude or other local conditions may require air shutter adjustment for proper combustion.

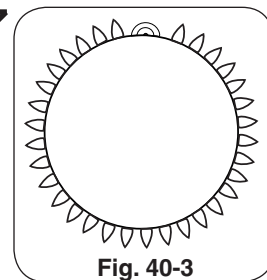

The flames from a properly adjusted sideburner will touch the burner ports and appear mostly blue.

If they are orange, "lazy," or lift off the burner ports, then adjust the sideburner air shutter using the following steps.

The sideburner air shutter is located underneath the sideburner shelf on the left side of the unit, near the wall of the cart. It can safely and easily be adjusted while the sideburner is lit.

CAUTION: Do not touch the sideburner or the shelf around it. They will be hot while adjusting the sideburner air shutter.

1. Light the sideburner following the lighting instructions in this manual.
2. Loosen the sideburner air shutter adjustment screw, then use the tip of the screwdriver to open or close the air shutter until the flames appear blue and touch the burner ports.
3. Retighten the adjustment screw.

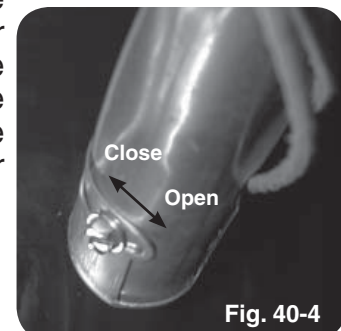

BURNER AIR SHUTTER ADJUSTMENT (Continued)

POWER BURNER

The flames from a properly adjusted power burner will touch the burner ports and appear mostly blue.

If they are orange, "lazy," or lift off the burner ports, then adjust the air shutter using the following steps.

Power burner air shutter adjustment is located on dual necks of the power burner where they connect with the gas manifold and orifices, as show in Fig. 41-1.

CAUTION: NEVER handle a hot burner.

To adjust the air shutters:

1. Remove the cooking grid and collimator.
2. Lift the back of the burner upward so that the pin in the bottom back clears the hole in the burner rest.
3. Move the burner back away from the front of the grill while continuing to lift the back upward so that it clears the rear fire wall.
4. Turn the shutter to the desired opening size and replace the burner to test the effect on the flame.

Burner flames should be mostly blue.

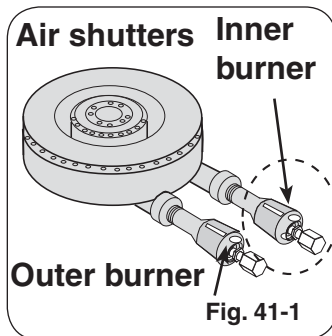

ADJUSTING THE LOW FLAME SETTING

After changing gas orifices and adjusting the regulator to burn a new gas, adjust the height of the flame **with a valve in LOW position so that is is low without going out**. Use the small adjusting screw in the center of the valve stem. This screw is accessible by removing the valve knob, which pulls straight off the end of the valve stem.

DOUBLE SIDEBURNER

The flames from a properly adjusted sideburner will touch the burner ports and appear mostly blue.

If they are orange, "lazy," or lift off the burner ports, then adjust the sideburner air shutter using the following steps.

The air shutters are located at the end of the burner assemblies, behind the control panel. They can safely and easily be adjusted while the unit is lit.

CAUTION: Do not touch the sideburner surrounding top area, as it will be hot while adjusting the air shutter.

1. Remove the double sideburner knobs, bezels, and control panel (only). (Reference IDENTIFICATION OF GRILL CONTROLS section for details.)
2. Replace the two double sideburner control knobs back on to the corresponding valve stems.
3. Light the sideburner following the LIGHTING INSTRUCTIONS section.
4. Loosen the front burner air shutter adjustment screw, then use the tip of a screwdriver to open or close the air shutter until the flames appear blue and touch the burner ports.
5. Retighten the adjustment screw.
6. Repeat for rear burner air shutter.

Should you have difficulty accessing the rear burner air shutter, you may shut down, remove the rear burner (when cool), then adjust the air shutter to the same opening as the already adjusted front burner. (See DOUBLE SIDEBURNER ORIFICE section to remove rear burner.) Be sure to properly reinstall rear burner when complete.

7. Once all adjustments are complete; be sure the unit is off and remove the knobs, then replace the control panel, bezels, and knobs.

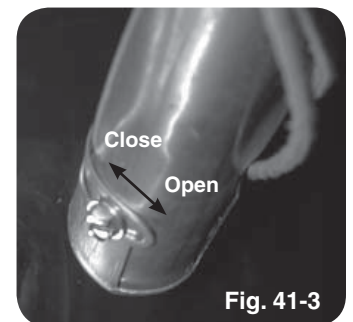
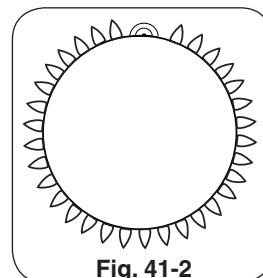

DOUBLE SIDEBURNER

SAFETY

The right knob controls the front burner and the left knob controls the back burner.

CAUTION: THE SIDEBURNER MUST COOL DOWN BEFORE HANDLING OR ADJUSTMENT.

Do not operate the sideburner with the cover closed.

Be sure the sideburner has good ventilation, is free of debris, and is away from flammable substances before lighting.

Properly burning flames are mostly blue and are steady and spread evenly around the burner.

STAINLESS STEEL SIDEBURNER COVER

Note: The cover is free-standing and is not hinged in the back.

To remove the cover, carefully lift off using the built in handle.

To replace the cover, put the back of the cover into position against the back inner lip of the sideburner grill rest and then lower the front into position so that it covers the side burner opening entirely.

ORIFICE INSPECTION AND REPLACEMENT

Please refer to Table 1 for the correct orifice size. Check the orifice size by following the instructions below. The drill size is stamped on the orifice. If the number is not visible you may have to remove the orifice (as detailed below) to read the number stamped on the side of the orifice.

If you are not sure you have the correct sideburner orifice size (or wish to change the orifice), follow the steps below.

CAUTION: If the burner has been in use, wait until the burner and its components are cool to the touch.

1. Turn off the gas shutoff valve. Remove sideburner lid and lift off cooking grid.
2. Remove the double sideburner knobs, bezels, and control panel (only). (Reference IDENTIFICATION OF GRILL CONTROLS section for details.)
3. Reach up under the burner support and remove the burner retaining clip (see Fig. 42-1), located at the rear of the burner pipe.
4. Remove the burner cap and carefully lift the burner up and out, clearing the ceramic electrode (see Fig. 42-2), and pulling the burner tube away from the orifice, located on the end of the orifice holder on the left side of the unit (see Fig. 42-3).

Note: You do not have to lift the burner completely out of the unit to access the orifice.

5. Using a $\frac{3}{8}$ " socket, remove orifice from the orifice holder (see Fig. 42-3) and check the number stamped on the orifice face.

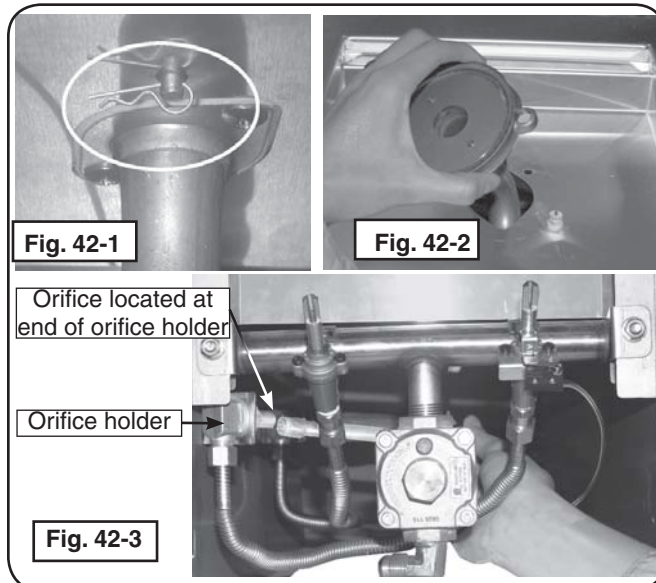

DOUBLE SIDEBURNER

6. If an orifice change is necessary, replace the orifice with the correct sized one.
7. Replace the sideburner tube over the orifice, aligning the burner over the electrode, taking care not to detach it from the wire.
8. Replace the burner retaining clip (underneath burner). Replace the burner cap.
9. Repeat steps 3 through 8 for the second burner, then replace the grid and lid.

Important: If converting the gas type, see the CHECKING AND CONVERTING THE REGULATOR section before replacing the control panel.

10. Once all adjustments are complete; be sure the unit is off and remove the knobs, then replace the control panel, bezels, and knobs.

WARRANTY

LIFETIME WARRANTY - Fire Magic® cast stainless-steel burners, stainless-steel rod cooking grids, and stainless-steel housings are warranted for as long as you own your Fire Magic® grill.

FIFTEEN-YEAR WARRANTY - Fire Magic® cast brass burners, brass valves, backburner assemblies (except ignition parts), and manifold assemblies are warranted for 15 years from the date of purchase of your Fire Magic® grill.

THREE-YEAR WARRANTY - Fire Magic® sideburners and all other Fire Magic® grill components (except ignition and electronic parts) are warranted for three (3) years from the date of purchase of your Fire Magic® grill.

Fire Magic® ignition systems (excluding batteries), electronic components (including lights and thermometers), and accessories are warranted for one (1) year from date of purchase.

PLEASE KEEP A COPY OF YOUR SALES SLIP FOR PROOF OF PURCHASE

This warranty applies to the original purchaser and to single family residential use only. It commences from date of purchase, and is valid only with proof of purchase.

This warranty does not cover parts becoming defective through misuse, accidental damage, electrical damage, improper handling, lack of routine maintenance, storage, and/or installation. Product must be installed (and gas must be connected) as specified in the instructions or operator's manual, by a **qualified professional installer**. Accessories, parts, valves, remotes, etc., when used must be Peterson Co. product.

This warranty **does not** apply to rust, corrosion, oxidation, or discoloration, unless the affected component becomes inoperable. It **does not** cover labor or labor-related charges.

This warranty specifically excludes liability for **indirect, incidental**, or consequential damages. Some states do not allow the exclusion or limitation of incidental or consequential damages, so the above exclusion may not apply to you. This warranty gives you specified legal rights, and you may have other rights that may vary from state to state.

For additional information regarding this warranty, or to place a warranty claim, contact the R.H. Peterson dealer where the product was purchased.

**TO REGISTER YOUR PRODUCT ONLINE GO TO: WWW.RHPETERSON.COM,
AND CLICK ON PRODUCT REGISTRATION. THANK YOU FOR YOUR PURCHASE.**

Quality Check			Date: _____		
Burner Orifices	Nat.	L.P.	Leak Test: _____	Model#: _____	
Main:	_____	_____	Burn Test: _____	Serial#: _____	
Back:	_____	_____	Gas Type: <u>Nat. / L.P.</u>	Air Shutter: _____	
Side/Power:	_____	_____		Inspector: _____	
Other:	_____	_____			