



Use & Care Guide

Wave-Touch™ Front-Load Washer



 **Electrolux**

Please read and save this guide

Thank you for choosing **Electrolux**, the new premium brand in home appliances. This *Use & Care Guide* is part of our commitment to customer satisfaction and product quality throughout the life of your new appliance.

We view your purchase as the beginning of a relationship. To ensure our ability to continue serving you, please use this page to record important product information.

Keep a record for quick reference

Purchase date

Electrolux model number

Electrolux serial number

NOTE

Registering your product with Electrolux enhances our ability to serve you. You can register online at www.electroluxappliances.com or by dropping your Product Registration Card in the mail.

Questions?

For toll-free telephone support in the U.S. and Canada: **1-877-4ELECTROLUX (1-877-435-3287)**

For online support and product information visit <http://www.electroluxappliances.com>

Table of contents

Finding information.....	2	• Saving Favorites	28-27
SAFETY	3-5	• Setting Preferences	28-31
Features.....	6	• Other Features.....	32
Operating Instructions.....	7-18	Cycle Chart.....	33
• Getting Started	7	Stain Removal Guide.....	34-35
• Normal Operating Sounds.....	7	• Stain Removal Procedures	34
• Operating Your Washer.....	8-13	• Stain Removal Suggestions.....	23
• Cycle Selection.....	14-18	Care & Cleaning.....	36-38
• Washing/Rinsing Temperature.....	19-20	Solutions to Common Problems	39-42
• Spin Speed	21	• Common Washing Problems.....	39-40
• Soil Level	21	• Service Prevention Checklist.....	41-42
• Options	22-24	Warranty Information.....	43
• User Interface Features	25	Notes.....	44

Important Safety Instructions

Recognize safety symbols, words and labels

Your safety and the safety of others is very important.

We have provided many important safety messages in the *Use and Care Guide, Installation Instructions* and on your appliance. Always read and obey all safety messages.

Safety items throughout this manual are labeled with a **WARNING** or **CAUTION** based on the risk type as described below:

 **WARNING** This symbol alerts you to situations that may cause serious body harm, death or property damage.

 **CAUTION** This symbol alerts you to situations that may cause bodily injury or property damage.

NOTE

The instructions appearing in this *Use and Care Guide* are not meant to cover every possible condition and situation that may occur. Common sense and caution must be practiced when installing, operating and maintaining any appliance.

WARNING

For your safety the following information in this manual must be followed to minimize the risk of fire or explosion or to prevent property damage, personal injury or death.

Do not store or use gasoline or other flammable vapors and liquids in the vicinity of this or any other appliance.

WHAT TO DO IF YOU SMELL GAS:

- Do not try to light any appliance.
- Do not touch any electrical switch; do not use any phone in your building.
- Clear the room, building or area of all occupants.
- Immediately call your gas supplier from a neighbor's phone. Follow the gas supplier's instructions.
- If you cannot reach your gas supplier, call the fire department.

Installation and service must be performed by a qualified installer, service agency or the gas supplier.

Save these instructions for future reference.

 **WARNING**

To reduce the risk of fire, electrical shock, or injury to persons when using this washer, comply with the basic warnings listed below. Failure to comply with these warnings could result in serious personal injuries.

You can be killed or seriously injured if you don't follow these important safety instructions:

PREVENT FIRE

- Do not wash items that have been previously cleaned in, soaked in, or spotted with gasoline, cleaning solvents, kerosene, cooking oils, waxes, etc. Do not store these items on or near the washer. These substances give off vapors or chemical reactions that could ignite or explode.
- Do not put oily or greasy rags or clothing on top of the washer. These substances give off vapors that could ignite the materials.
- Do not add gasoline, cleaning solvents, or other flammable or explosive substances to the wash water. These substances give off vapors that could ignite or explode.
- Under certain conditions, hydrogen gas may be produced in a hot water system that has not been used for 2 weeks or more. **HYDROGEN GAS IS EXPLOSIVE.** If the hot water system has not been used for such a period, before using the washer, turn on all hot water faucets and let the water flow from each for several minutes. This will release any accumulated hydrogen gas. Hydrogen gas is flammable; do not smoke or use an open flame during this time.
- Do not store or use gasoline or other flammable vapors or liquids in the vicinity of this or any other appliance.
- Failure to comply with these warnings could result in fire, explosion, serious bodily injury and/or damage to the rubber or plastic parts of the washer.

PROTECT CHILDREN

- Do not allow children to play on or in the washer. Close supervision of children is necessary when the washer is used near children. As children grow, teach them the proper, safe use of all appliances.
- Destroy the carton, plastic bag and other packing materials after the washer is unpacked. Children might use them for play. Cartons covered with rugs, bedspreads or plastic sheets can become airtight chambers.
- Keep laundry products out of children's reach. To prevent personal injury, observe all warnings on product labels.
- Before the washer is removed from service or discarded, remove the washer door to prevent accidental entrapment.
- Failure to comply with these warnings could result in serious personal injuries.

Important Safety Instructions, con't

PREVENT INJURY

- To prevent shock hazard and assure stability during operation, the washer must be installed and electrically grounded by a qualified service person in accordance with local codes. Installation instructions are packed in the washer for installer's reference. Refer to **INSTALLATION INSTRUCTIONS** for detailed grounding procedures. If the washer is moved to a new location, have it checked and reinstalled by a qualified service person.
- To prevent personal injury or damage to the washer, the electrical power cord of the washer must be plugged into a properly grounded and polarized 3-prong outlet. The third grounding prong must never be removed. Never ground the washer to a gas pipe. Do not use an extension cord or an adaptor plug.
- Follow package directions when using laundry products. Incorrect usage can produce poisonous gas - resulting in serious injury or death.
- Do not combine laundry products for use in 1 load unless specified on the label.
- Do not mix chlorine bleach with ammonia or acids such as vinegar.

WARNING

FIRE/ELECTRICAL SHOCK HAZARD

Avoid fire hazard or electrical shock. Do not use an adaptor plug or extension cord or remove grounding prong from electrical power cord. Failure to follow this warning can cause serious injury, fire or death.



PREVENT INJURY AND DAMAGE TO THE WASHER

- To prevent serious personal injury and damage to the washer:
- All repairs and servicing must be performed by an authorized servicer unless specifically recommended in this **Use & Care Guide**. Use only authorized factory parts.
- Do not tamper with controls.
- Do not install or store the washer where it will be exposed to the weather.
- Do not install on carpet. Install washer on a solid floor. It may be necessary to reinforce the floor to prevent vibration or movement.
- To reduce the risk of electric shock, disconnect this appliance from the power supply before attempting any user maintenance. Turning the controls to the OFF position does not disconnect this appliance from the power supply.
- To prevent injury, do not reach into the washer while parts are moving. Before loading, unloading or adding items, push in the cycle selector knob and allow the drum to coast to a complete stop before reaching inside.
- This washer is equipped with an electrical overload protector. The motor will stop if it becomes overheated. The washer will automatically restart after a cool down period of up to 30 minutes, if the washer has not been manually turned off during this time.
- Failure to comply with these warnings could result in serious personal injuries.

WARNING

HARMFUL VAPOR HAZARD

Do not use or mix liquid chlorine bleach with other household chemicals such as toilet cleaners, rust removers, acid or products containing ammonia. These mixtures can produce dangerous fumes which can cause serious injury or death.



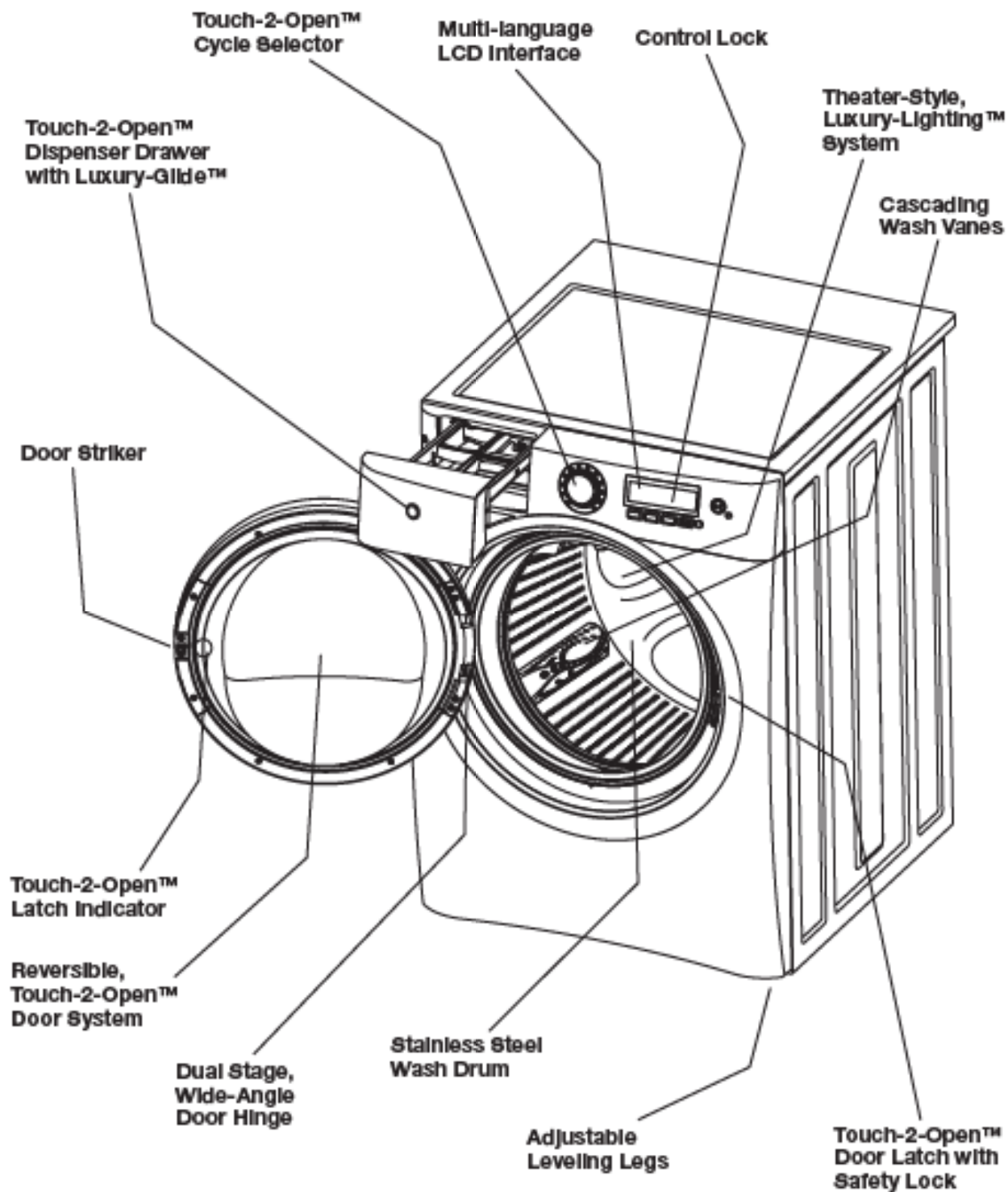

As an ENERGY STAR® Partner, Electrolux Major Appliances has determined that this product meets the ENERGY STAR® guidelines for energy efficiency.

Getting Started

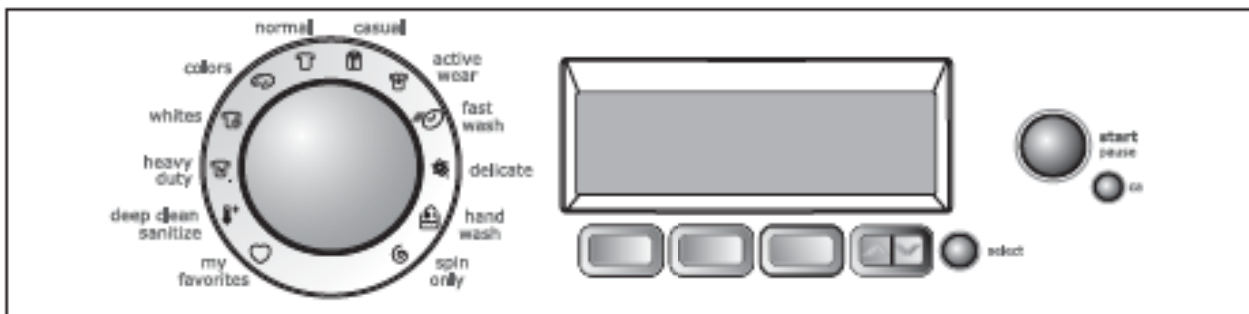

To run your washer, follow these basic steps:

1. Sort laundry into loads that can be washed together. (See page 8.)
2. Prepare items for washing. (See page 8.)
3. Pretreat stains and heavy soil. (See page 9.)
4. Add laundry load to the washer. (See page 9.)
5. Add laundry products to the dispenser. (See page 10-11.)
6. Select the appropriate cycle and settings for the load. (See page 12.)
7. Start the washer. (See pages 12-13.)

Normal Operating Sounds

You may or may not hear the following sounds from your new washer:

- A. DRAIN HOSE** The washer has a flexible drain hose to carry water from the washer to the stand pipe of your home. You will hear water flowing into your stand pipe. This is a normal part of the operation of the washer.
- B. WATER VALVES/DISPENSER** As water enters the dispenser system, it is common to hear a water flowing sound. This normal sound will vary slightly based on the water pressure in your home.
- C. DOOR LOCK** Your washer is equipped with a door lock with an electric solenoid. There will be a clicking sound as the washer door is being locked or unlocked.
- D. DRAIN PUMP** Your washer is equipped with a high velocity drain pump. It is normal to hear humming and gurgling sounds as water is pumped from the washer. Both of these sounds are normal and indicate that your pump is functioning correctly.
- E. HIGH SPEED MOTOR** A powerful motor is used to drive the drum to high spin speeds to extract water from your load. You will hear a sound associated with these higher spin speeds. This sound is normal and will vary slightly as the spin speed varies with load size and cycle selected.

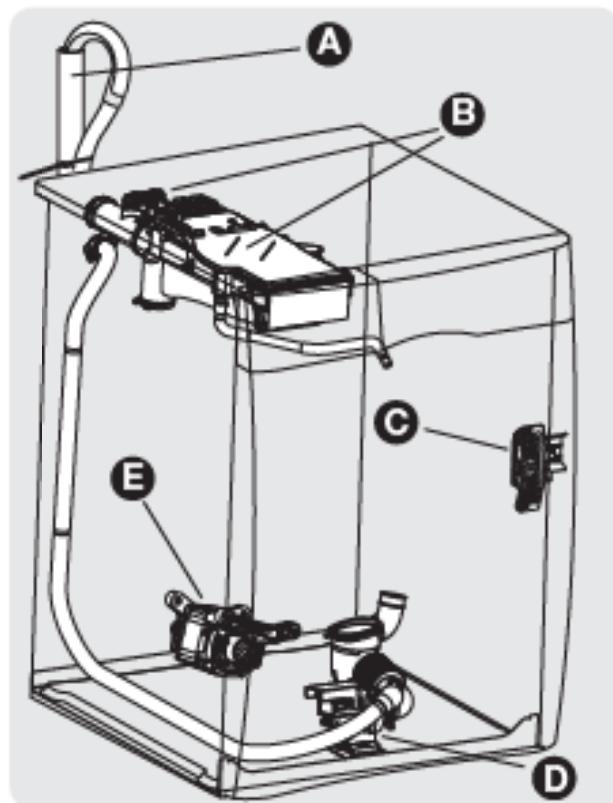

Operating Your Washer

BEFORE USING YOUR WASHER

Read the important instructions in this section of the *Use and Care Guide* before operating your washer.

WARNING

To reduce the risk of fire, electric shock or injury to persons, read the IMPORTANT SAFETY INSTRUCTIONS in this *Use and Care Guide* before operating your washer.

OPERATING YOUR WASHER

1. Sort laundry into loads that can be washed together.

Sort items by recommended cycle and water temperature.

Separate white, light and colorfast items from dark and non-colorfast items.

Separate items that shed lint from items that attract lint. Casual, synthetic, knit, and corduroy items will pick up lint from towels, rugs, and chenille bedspreads.

Separate heavily soiled items from lightly soiled items.

Separate lacy, sheer, loosely knit, or delicate items from durable items.

Do not machine wash items containing fiberglass. Small particles of fiberglass left in the drum may transfer to fabrics in other loads and cause skin irritation.

2. Prepare items for washing.

Empty pockets.

Brush off lint and dirt. Shake out rugs and beach towels.

Close zippers, fasten hooks, tie strings and sashes, and remove non-washable trims and ornaments.

Mend rips and tears to prevent further damage during washing.

Turn knit items inside out to prevent pilling.

Place delicate and small items such as bras, hosiery and baby socks in a mesh bag.

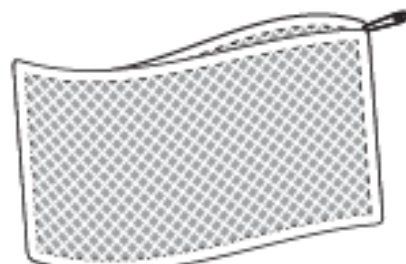
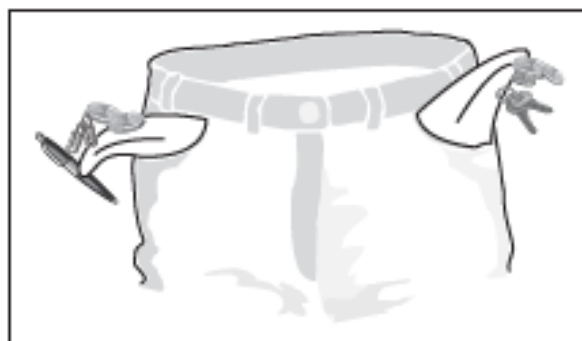

(Mesh bag not included.)

OPERATING YOUR WASHER, con't

3. Pretreat stains and heavy soil.

See **Stain Removal Guide** in this guide or **Stain Guides** in the LCD User Interface for safe, successful stain removal instructions.

4. Add laundry load to washer.

Combine large and small items in a load.

Load large items first. Large items should not be more than half the total wash load.

Washing single items such as a sweater, towel or jeans is inefficient and may cause an out-of-balance load. Add 1 or 2 similar items to help balance the load.

Wash a single heavy item such as a king-sized comforter, bedspread or sleeping bag separately.

The washer can be fully loaded, but the items should not be tightly packed. The door should close easily.

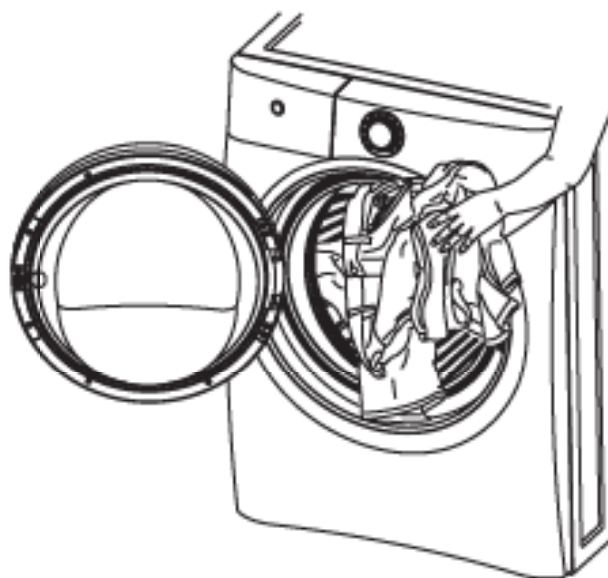

OPERATING YOUR WASHER, con't**5. Add laundry products to the dispenser.****For best results**

Use a low-sudsing, high efficiency detergent to prevent oversudsing in front load washers. Look for this symbol on the detergent label: 

Detergent, liquid chlorine bleach and liquid fabric softener will be dispensed at the proper times in the cycle. To unlatch the dispenser drawer push on the dispenser drawer latch indicator. To close and latch the dispenser drawer push the drawer in until you hear a slight click with the drawer face flush to the panel.

 **IMPORTANT**

Open and close the dispenser drawer slowly. Closing the drawer too quickly could result in early dispensing of the bleach or fabric softener.

Use the cap or scoop provided by the detergent manufacturer to measure the amount recommended. Detergent dosage may need to be adjusted for water temperature, water hardness, load size and soil level.

Liquid Detergent 

Add the recommended amount of a high efficiency liquid detergent to the "Main Wash - liquid only" cup. Do not exceed the **MAX** fill line. Liquid detergent can also be added directly to the "Main Wash - powder only" chamber when not using the "Pre-Wash" option.

 **NOTE**

From time to time you may see water in the "Main Wash - liquid only" chamber. This is part of the normal operation of the washer.

Powder Detergent 

To use a high efficiency powder detergent, remove the "Main Wash - liquid only" cup and add the powder directly to the "Main Wash - powder only" detergent chamber.

 **IMPORTANT**

Save the liquid cup insert for future use. **DO NOT** discard it while you are using powder detergent.

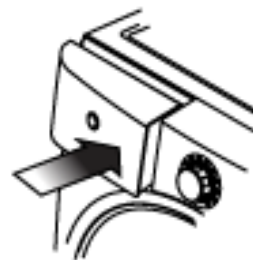
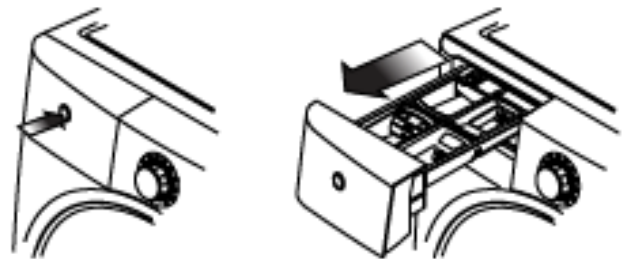

Insert liquid cup when using liquid detergent.

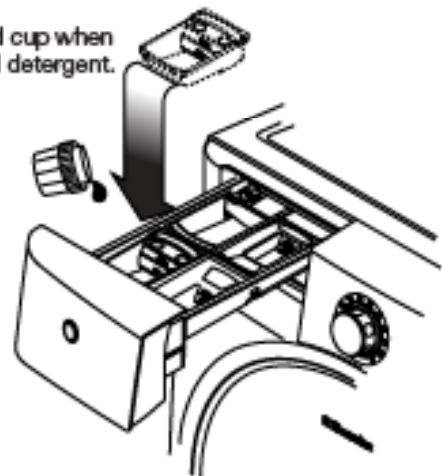

Remove liquid cup when using powder detergent! **DO NOT** pour powder detergent into liquid cup. It will not dispense correctly!

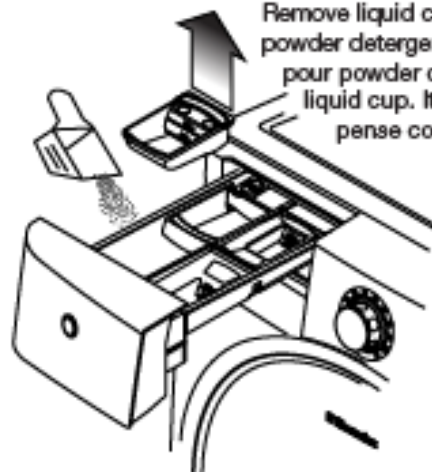

OPERATING YOUR WASHER, con't

Other Wash Products

Color-safe bleach, water conditioner, detergent booster and enzyme products may be added with the detergent. Put liquid products with liquid detergent in the "Main Wash - liquid only" detergent cup or powder products with powder detergent in the "Main Wash - powder only" detergent chamber.

➔ IMPORTANT

Do not mix liquids and powders.

Detergent for Prewash

For heavily soiled or stained loads, select the prewash option and add the recommended amount of detergent to the "Pre-Wash" detergent cup.

🗨 NOTE

From time to time you may see water in the "Main Wash - liquid only", "Liquid Bleach" and "Fabric Softener" chambers. This is part of the normal operation of the washer.

Liquid Chlorine Bleach

If desired, add liquid chlorine bleach to the chamber labeled "Liquid Bleach" and marked with this symbol . Fill to the **MIN** line for small loads or the **MAX** line for large loads. **DO NOT** fill above the maximum fill line.

Add color-safe bleach with the detergent.

➔ IMPORTANT

To prevent fabric damage, do not overfill the "Liquid Bleach" chamber or pour liquid chlorine bleach directly onto the load.

Liquid Fabric Softener

If desired, pour the recommended amount of liquid fabric softener into the chamber labeled "Fabric Softener" and marked with this symbol . Fill to the **MIN** line for small loads or the **MAX** line for large loads. **DO NOT** fill above the maximum fill line.

🗨 NOTE

To prevent staining, do not overfill the "Fabric Softener" chamber or pour liquid fabric softener directly on the wash load.

Use of a fabric softener-dispensing ball is not recommended in tumble action washers.

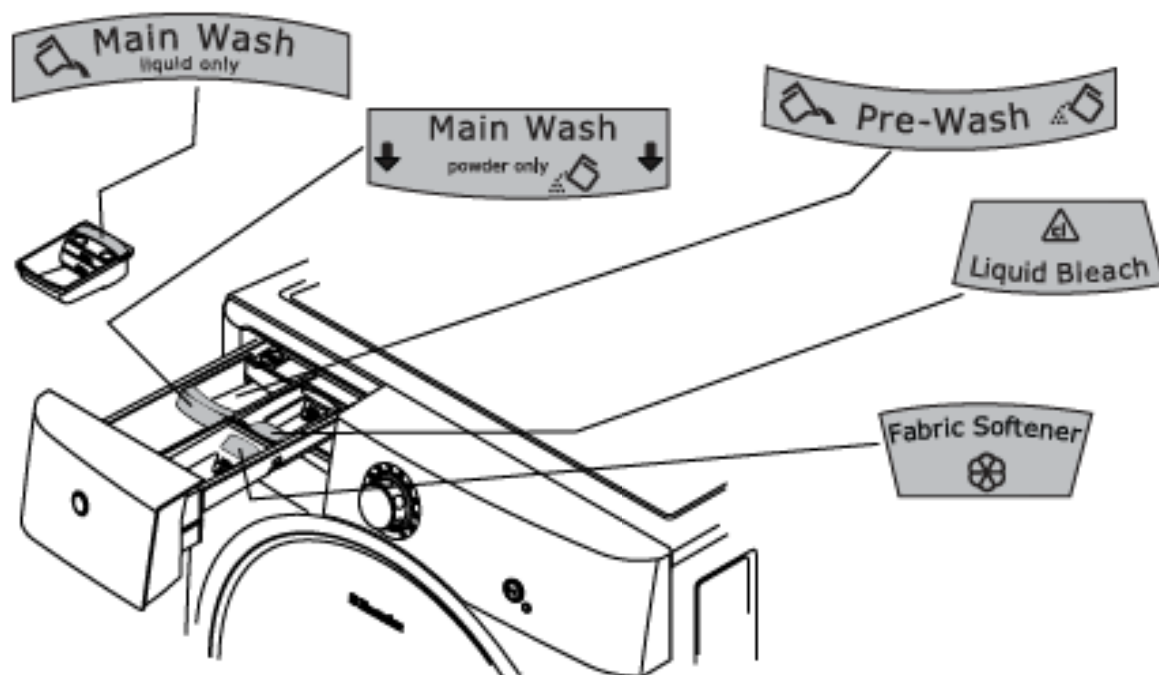

12 Operating Instructions

OPERATING YOUR WASHER, con't

6. Select the appropriate cycle and settings for the load.

Turn the cycle selector knob in either direction to select the cycle desired. The icon for that cycle will be illuminated and if the cycle description feature is turned on, the cycle and estimated cycle time are displayed on the User Interface screen for 5 seconds. Press any key to advance the User Interface to select settings and options. See the "Cycle Selection" section in this guide for descriptions of each cycle.

Press any key or the User Interface screen will automatically advance after 5 seconds and display the preset wash water temperature, final spin speed and soil level for each cycle. See the "Cycle Settings" and "Cycle Selection Chart" in this guide for descriptions and available settings for each cycle.

To change the settings, press the **temp**, **spin speed**, and **soil level** buttons to scroll to the desired settings. Press the scroll up or scroll down buttons under **options** to scroll through the **options** menu. Press the **select** button to add or delete **options**. The estimated cycle time will be displayed at the top of the screens.

NOTE

To provide the best care of your laundry, not every setting or option is available with every cycle. If a setting is not available for the cycle selected, it will not be displayed.

Adjustments to a cycle will be remembered and recalled each time that cycle is selected in the future.

To return to the factory default settings, select **RESET** in **set prefs** under the **options** scroll buttons.

To customize and save up to 3 cycles in non-custom mode plus 9 more cycles for custom users, see **save as favorite** and **CUSTOM MODE** in the User Interface sections of this guide.

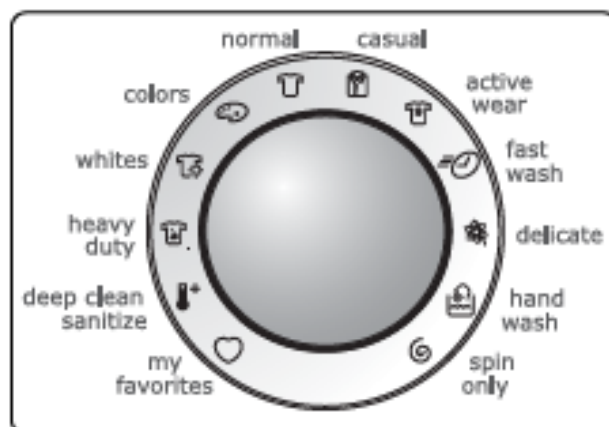

As the Cycle Selector knob is turned, the cycle and estimated cycle time are displayed on the User Interface screen for 5 seconds. Press any key to advance the User Interface to select settings and options.

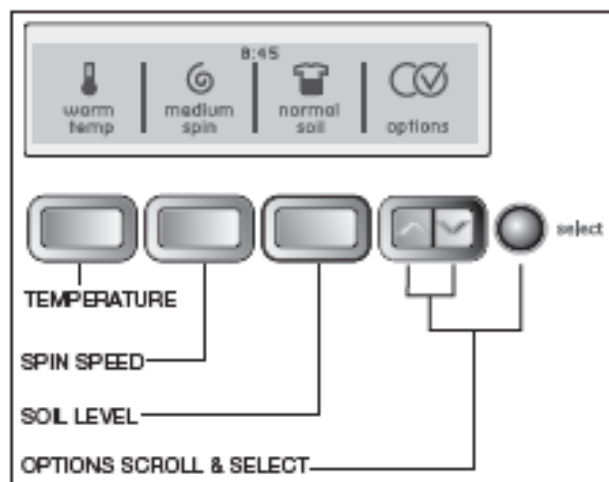

OPERATING YOUR WASHER, con't

7. Start the washer.

Close the door and press **start**. The washer will not operate with the door unlatched and **DOOR OPEN** will be displayed.

Select **delay start** to delay the beginning of the cycle for up to 22 hours if desired.

As a safety measure, the door will automatically lock and remain locked during the entire wash cycle and **DOOR LOCKED** will be displayed.

To add a forgotten item to the washer any time during the wash portion of the cycle, press **pause**. When the door unlocks, open the door, add the item, close the door and press **start** to resume the cycle.

To change the cycle once the cycle has begun, press **cancel**, select a new cycle, and press **start** again. Just turning the cycle selector knob will not change the cycle.

To change settings or options after the cycle has begun, press **pause**, select the new settings or options, and press **start** again.

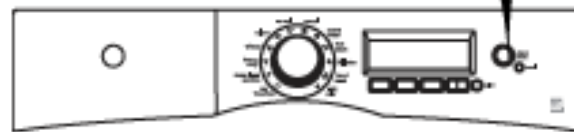

NOTE

If the cycle is interrupted during spin, the door lock will not release until the tub has stopped spinning. **DO NOT** force open the door.

To stop the cycle, press **cancel**.

When the cycle ends, a signal will sound, **COMPLETE - DOOR CAN BE OPENED** will be displayed and the drum light will come on.

Remove items from the wash drum when the cycle ends and place in dryer, line dry or dry flat as directed on the fabric care label.

Excess wrinkling, color transfer or odors may develop in items left in the washer after the cycle has ended if not removed promptly.



For best results

Follow the fabric care label instructions on items to be washed.

CAUTION

ENTRAPMENT and TIP-OVER HAZARD

An open door could entice children to hang on the door or crawl inside the washer. If there are no small children present, you may leave the door ajar to prevent mildew and odor build up.

Cycle Selection

Turn the cycle selector in either direction to the cycle desired. The icon for that cycle will be illuminated. Press on the cycle selector knob to extend it or return it flush to the console.



For best results

Follow the fabric care label instructions on items to be washed.

To change the selection after the cycle begins, press **cancel** before making another choice. Just turning the cycle selector knob to another selection will not change the cycle.

NORMAL

The **normal** cycle provides 9-21 minutes of reversing tumble wash action for most loads. All water temperatures except **sanitize temp**, all **spin** speeds, **soil** levels and **options** are available with this cycle.

COLORS

The **colors** cycle provides 5-20 minutes of reversing tumble wash action for mixed color loads. **Warm temp**, **eco warm temp** or **cold temp** water, all **spin** speeds, **soil** levels and **options** except **warm rinse** are available with this cycle.

WHITES

The **whites** cycle provides 9-21 minutes of reversing tumble wash action for whiter cottons. The use of liquid chlorine bleach is recommended. **Hot temp** and **eco hot temp** water, all **spin** speeds and **soil** levels, and all **options** except **warm rinse** are available with this cycle.

HEAVY DUTY

The **heavy duty** cycle provides 9-21 minutes of reversing tumble wash action for heavily soiled sturdy items such as jeans. For best soil and stain removal, use the hottest water safe for the fabrics being washed. All temperatures except **sanitize temp**, all **spin** speeds, all **soil** levels except **light soil** and **extra light soil**, and all **options** are available with this cycle.

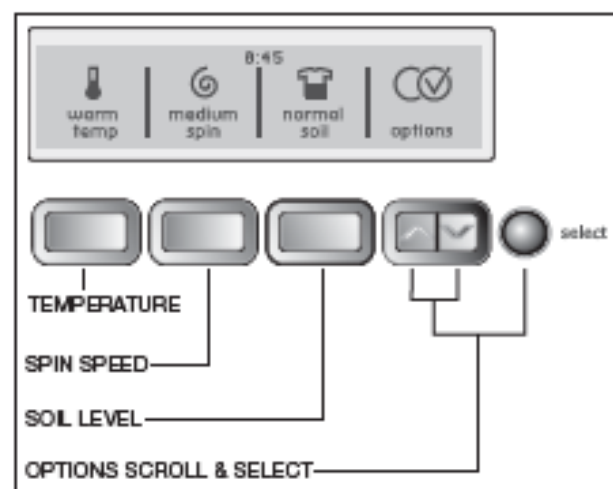
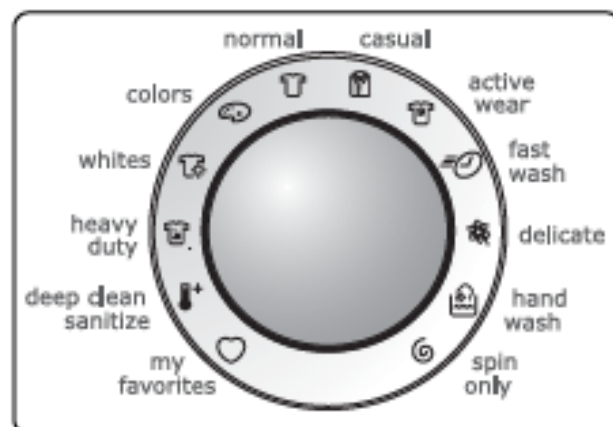

Cycle Selection, con't

DEEP CLEAN SANITIZE

Use the **deep clean sanitize** cycle to clean and sanitize heavily soiled, colorfast fabrics including towels, bedding, and children's clothing. Very hot water, all spin speeds, all soil levels except **light soil** and **extra light soil**, and all options except **prewash**, **eco friendly**, **stain clean**, and **warm rinse** are available with this cycle.

It is recommended that you set your water heater to 120° F (49° C) or higher to ensure proper performance during this cycle. If the setting is lower or the load is extra large, the cycle time will be extended by 30 minutes or more.

The **deep clean sanitize** cycle will kill 99.9% of bacteria with no carryover of bacteria between loads. No bleach or harsh chemicals are needed, but higher temperatures are required. Please check fabric care labels to prevent damage.

NOTE

This cycle has been certified by NSF International, an independent third party testing and certification organization dedicated to public health, safety and environmental protection.

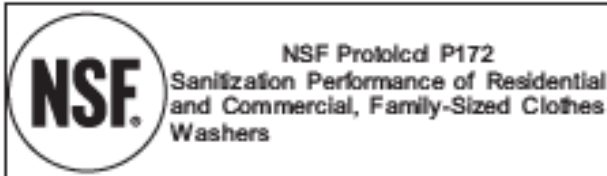

The wash water is heated by an internal boost heater to a maximum of 152° F (67° C) as the load tumbles for up to 4 hours. Cold water is added to cool down the load prior to drain and spin.

NOTE

If the voltage at your outlet is under 110 v, the internal heater may not adequately heat the wash water. If the cycle is interrupted while the water is heating, the final temperature of the wash water may be lower and sanitation may be reduced.

As a precaution, the washer door is locked once the water temperature reaches 130° F (55° C). If the cycle is cancelled during the wash phase and the water temperature is greater than 150° F (66° C), an automatic cool down and drain will occur before the door can be opened.

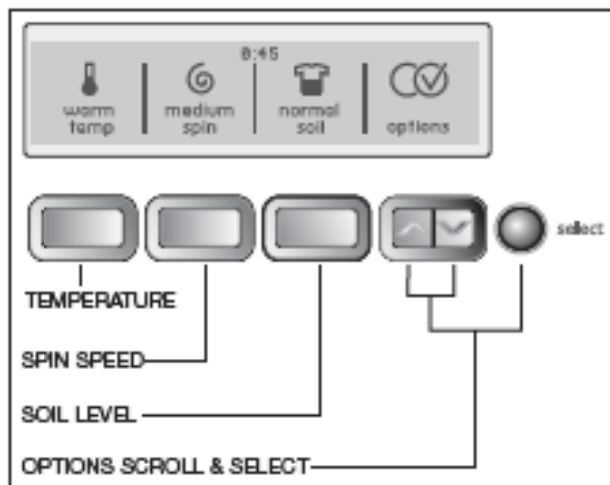
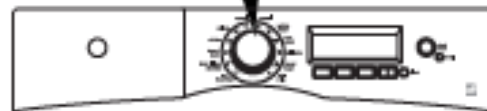
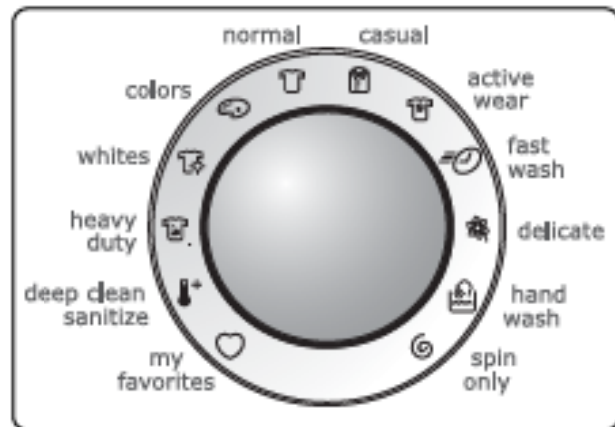

16 Operating Instructions

Cycle Selection, con't

CASUAL

The **casual** cycle provides 5-20 minutes of reversing tumble action for cottons and blends with a permanent press or no-iron finish. All temperatures except **sanitize temp**, all **spin** speeds and **soil** levels, and all **options** except **warm rinse** are available with this cycle.

ACTIVE WEAR

The **active wear** cycle provides 5-17 minutes of reversing tumble wash action for lightweight, synthetic athletic apparel. All temperatures except **sanitize temp**, **hot temp** and **eco hot temp**, all **spin** speeds, **soil** levels and **options** are available with this cycle.

FAST WASH

The **fast wash** cycle provides 5-11 minutes of reversing tumble action to quickly wash small, lightly soiled loads in 18 minutes. All water temperatures except **sanitize temp**, all **spin** speeds, all **soil** levels except **heavy soil**, **extra heavy soil** and **heaviest soil**, and **eco friendly**, **delay start** and **warm rinse options** are available with this cycle.

DELICATE

The **delicate** cycle provides 6-12 minutes of gentle reversing tumble action for knits and delicates. All water temperatures except **eco hot temp**, **hot temp** and **sanitize temp**, all **spin** speeds, all **soil** levels except **heavy soil**, **extra heavy soil** and **heaviest soil**, and all **options** except **prewash** and **extra spin** are available with this cycle.

HAND WASH

The **hand wash** cycle provides 5-11 minutes of intermittent gentle tumbling for items labeled "Hand Wash". All water temperatures except **eco hot temp**, **hot temp** and **sanitize temp**, all **spin** speeds, all **soil** levels except **heavy soil**, **extra heavy soil** and **heaviest soil**, and the **eco friendly**, **delay start** and **extra rinse options** are available with this cycle.

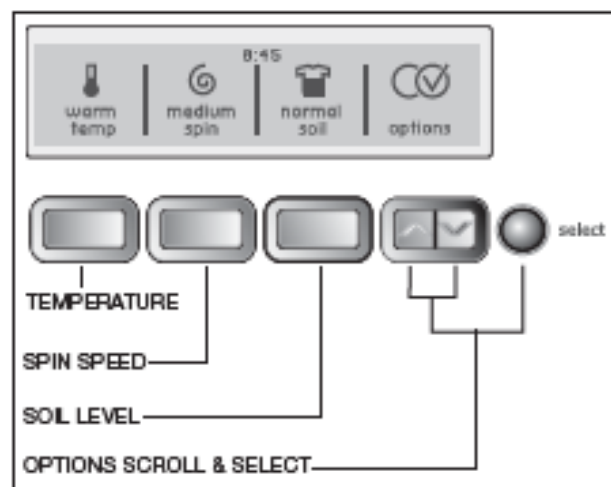
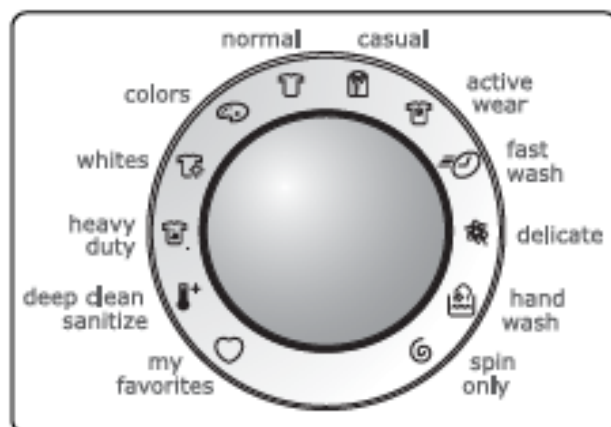

Cycle Selection, con't

SPIN ONLY

Use the **spin only** cycle anytime you want to drain water from the washer and spin out the load or as a follow-up to the **no spin** setting. Select the speed appropriate for the load for 8 minutes of spin.

To add a cold water rinse prior to the spin, select the **extra rinse** option.

MY FAVORITE

To select one of your 3 favorite cycles:

- Turn the cycle selector knob to **my favorites**.
- Press the button corresponding to the favorite cycle desired. The custom cycle, settings, and options you saved will automatically be displayed.
- Press the **start** button to begin the cycle.

For example, to select your **my shirts** cycle, turn the cycle selector knob to **my favorites**. Press the button corresponding to **my shirts**, and then press **start**.

(See **save as favorite** in the "Operating User Interface Preferences" section of this guide for instructions on customizing up to 3 cycles.)

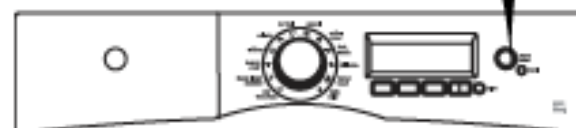
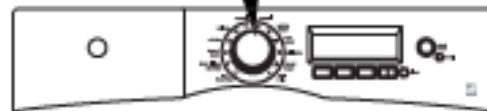
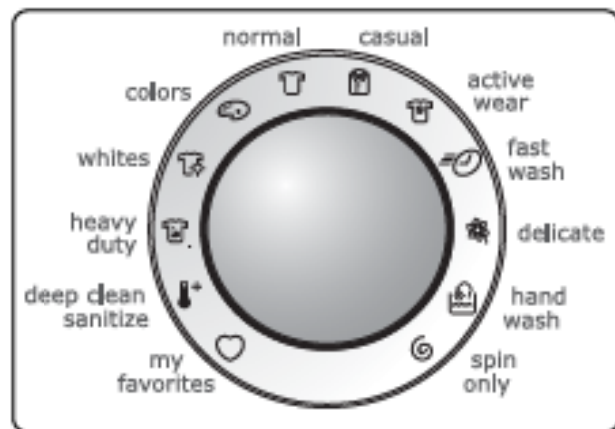

MY FAVORITES , con't

If more than one user has been entered in **CUSTOM MODE**:

- The current user's name will be displayed when the washer is turned on if **CUSTOM MODE** is on.
- Press the button under **OH** to continue using that user's favorite cycles.
- The icon for the last cycle run will light up.
- Turn the cycle selector knob to **my favorites**.
- Select one of the 3 customized cycles by pressing the corresponding button.
- Press the **start** button.

To change users:

- Press the **select** button when the washer turns on and shows the current user's name.
- Press the button under **change users**.
- Select another user's name.
- Press the button under **EXIT**.
- The icon for the last cycle run will light up.
- Turn the cycle selector knob to **my favorites**.
- Select one of the 3 customized cycles by pressing the corresponding button.
- Press the **start** button.

To select a user if a user's name is not displayed when the washer is turned on:

- Press the **options** buttons to scroll to **set prefs** and then press the **select** button.
- If necessary, press the **options** buttons to scroll to **CUSTOM MODE** and then press the **select** button.
- Press the button corresponding to the user's name.
- The icon for the last cycle run will light up.
- Turn the cycle selector knob to **my favorites**.
- Select one of the 3 customized cycles by pressing the corresponding button.
- Press the **start** button.

(See **CUSTOM MODE** in "Operating User Interface Preferences" in this guide for instructions entering new users and naming favorite cycles.)

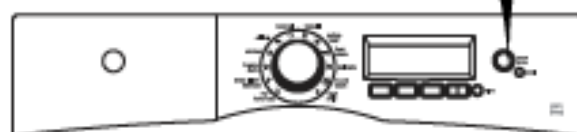
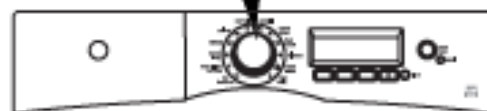
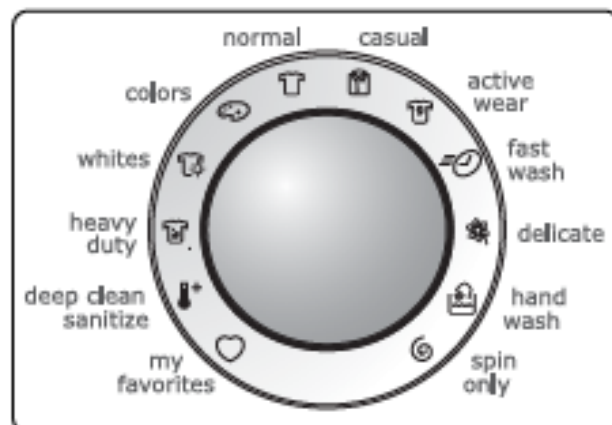

Washing/Rinsing Temperature

The appropriate washing temperature will automatically be indicated for the cycle selected.



For best results

Follow the fabric care label instructions on items to be washed.

To change the temperature, press the **temperature** button to scroll to the desired setting. Select a wash water temperature according to fiber content, colorfastness and soil level. A cold water rinse saves energy and reduces wrinkling.

To protect your fabrics, not all temperatures are available with every cycle. Settings will not be displayed if they are not available with that cycle. See the "Washer Settings Chart" in this guide for more information.

The temperature selected for the cycle will be remembered and recalled each time that cycle is selected in the future.



NOTE

To change the temperature once the cycle has begun, press the **pause** button, make the new selection and press **start** again.

All wash water temperatures are automatically regulated to maximize detergent effectiveness and improve washing performance. The washer will operate with tap water temperatures if desired. See **auto temp** in the "Options" section of this guide for more information. However, the water heater setting and its distance from the washer, water usage in other parts of the home, and seasonally low ground water temperature in some geographic areas can affect water temperature and impact the performance of your washer.

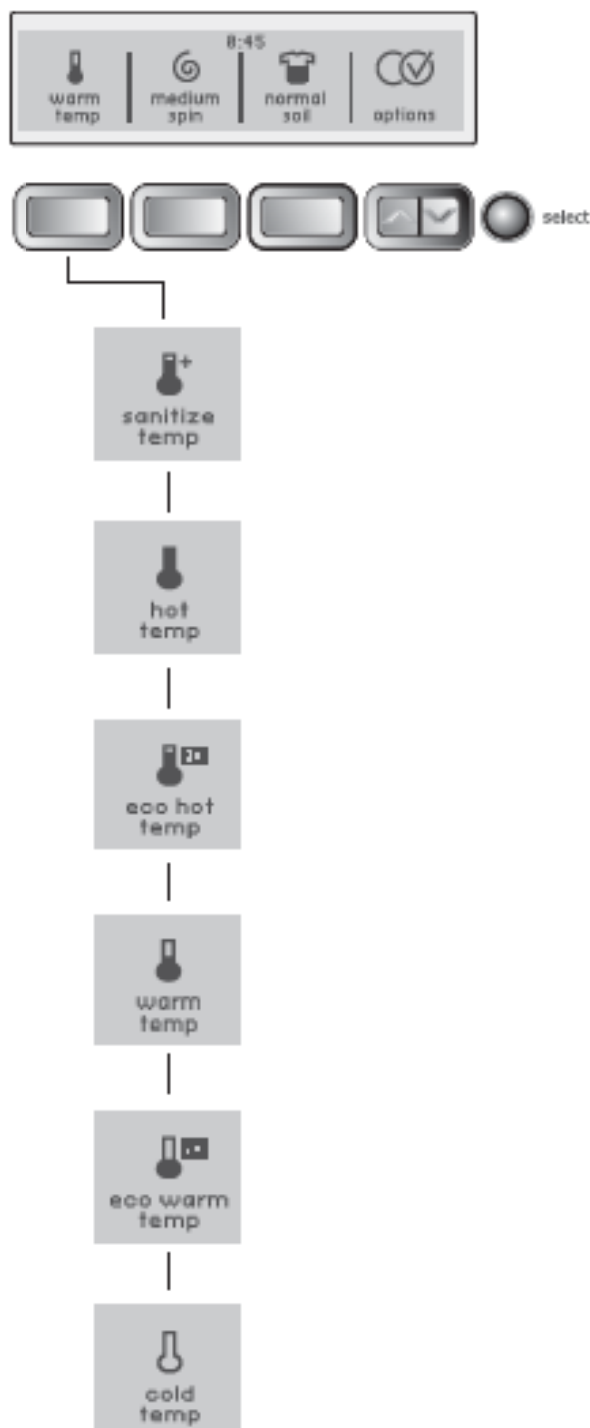

Temperature, con't

COLD TEMP

Use this setting for lightly soiled, brightly colored items, knits, delicates, hand washables and washable silk.

ECO WARM TEMP

Reduces the warm water temperature a few degrees to save energy when washing normally soiled, colorfast cottons, sheets, casual items and washable woolens.

WARM TEMP

Use this setting for normally soiled, colorfast cottons, sheets, perm press items and washable woolens.

ECO HOT TEMP

Reduces the warm water temperature a few degrees to save energy when washing heavily soiled, white and colorfast cottons and towels.

HOT TEMP

Use this setting for heavily soiled, white and colorfast cottons and towels.

SANITIZE TEMP

This setting sanitizes heavily soiled white and colorfast fabrics such as towels, bedding, and children's clothing by killing 99.9% of bacteria using wash water heated with a boost heater to 152° F (67° C). Cold water is used to cool and rinse the load. This setting is only available with the **deep clean sanitize** cycle.

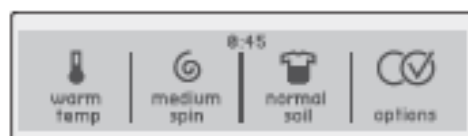

Spin Speed

Maximum spin, high spin, medium spin, minimum spin, and low spin speeds are available for each cycle. The spin speed and/or duration of final spin vary from cycle to cycle.

Increasing the spin speed will extract more water, decrease drying time and conserve energy. Decreasing the spin speed will reduce wrinkling.

Use no spin to omit the final spin at the end of the cycle. The load will be very wet. Remove items from the wash drum to drip dry or select the spin only cycle to remove excess water at a more convenient time.

Soil Level

Adjust the wash time in 3-minute increments based on the soil level of each load. Normal soil, heavy soil, extra heavy soil, heaviest soil, light soil and extra light soil levels are available.

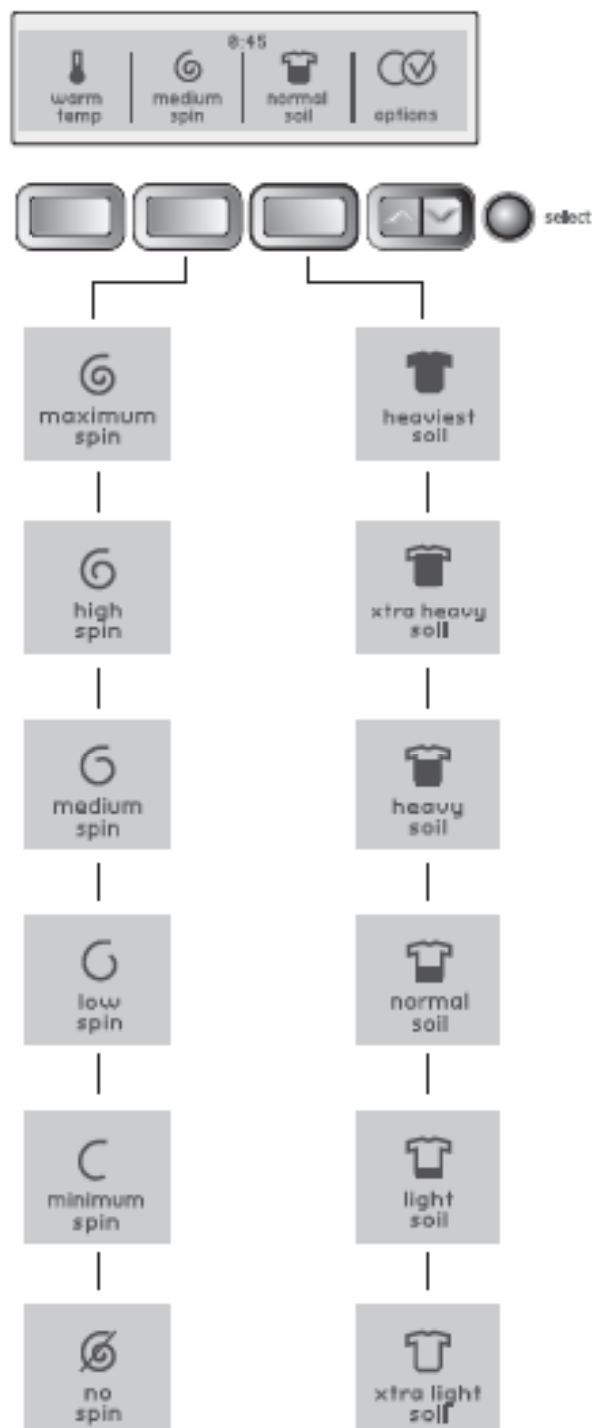

Options

Suitable options will automatically be indicated when the cycle is selected.

To select or clear the **eco friendly**, **stain clean**, **extra rinse**, **auto temp**, **extra spin**, **prewash**, **warm rinse** and **delay start** options, press the scroll up or scroll down buttons under options buttons until the desired option is displayed. Press **select** and **ON** will be displayed in the upper right corner. To clear the option, press **select** again and **ON** will disappear.

To protect your fabrics, not all options are available with every cycle. If an option is not appropriate for the cycle, it will not be displayed.

NOTE

To change the options once the cycle has begun, press the pause button, make the new selections and press start again.

The options selected for the cycle will be remembered and recalled each time that cycle is selected in the future.

ECO FRIENDLY

The **eco friendly** option reduces the hot and warm water temperature a few degrees to save energy. It is available with all cycles except **deep clean sanitize** and **spin only**.

STAIN CLEAN

Use the **stain clean** option to add a 5-minute soak in the middle of the wash portion of the **normal**, **colors**, **casual**, **active wear**, **whites**, **heavy duty** and **delicates** cycles.

EXTRA RINSE

Use this option when additional rinsing is desired to remove excess dirt or detergent. It is recommended for heavily soiled loads or if household members have sensitive skin. It is available with all cycles except **fast wash**. **Extra rinse** occurs before the final rinse when the liquid fabric softener is dispensed.

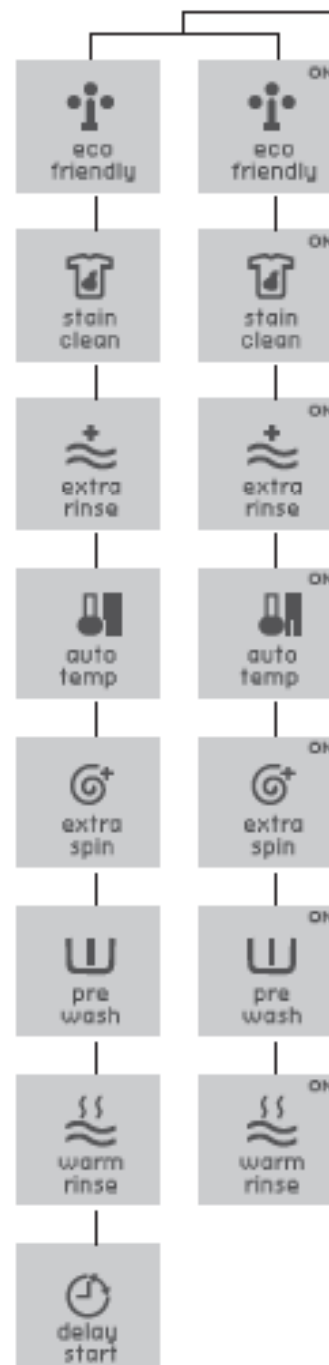

Options, con't

AUTO TEMP

The wash and rinse water temperatures are automatically regulated to maximize detergent effectiveness and improve washer performance. It is available with all cycles.

To delete this option and operate the washer with tap water temperatures, press **select** and **ON** will no longer be displayed. However, the water heater setting and its distance from the washer, water usage in other parts of the home, and seasonally low ground water temperature in some geographic areas can affect water temperature and impact the performance of your washer.

EXTRA SPIN

Use this option to add several minutes to the final spin at the selected speed. This will improve water extraction, decrease drying time and save energy. **Extra spin** is available with all cycles except **fast wash**, **delicates**, **hand wash** and **spin only**.

PREWASH

Select this option to add a short wash period prior to the **normal**, **colors**, **casual**, **active wear**, **whites**, and **heavy duty** cycles. Heavily soiled and stained loads will prewash in cold water for 5 minutes. The water will drain and the load will automatically advance to the selected wash cycle.

See Step 5 in the "Operating Your Washer" section in this guide for details on adding detergent to the "Pre-Wash" cup in the dispenser.

WARM RINSE

Select the warm rinse option with the **normal**, **heavy duty**, **active wear**, **fast wash**, **delicates** and **hand wash** cycles.

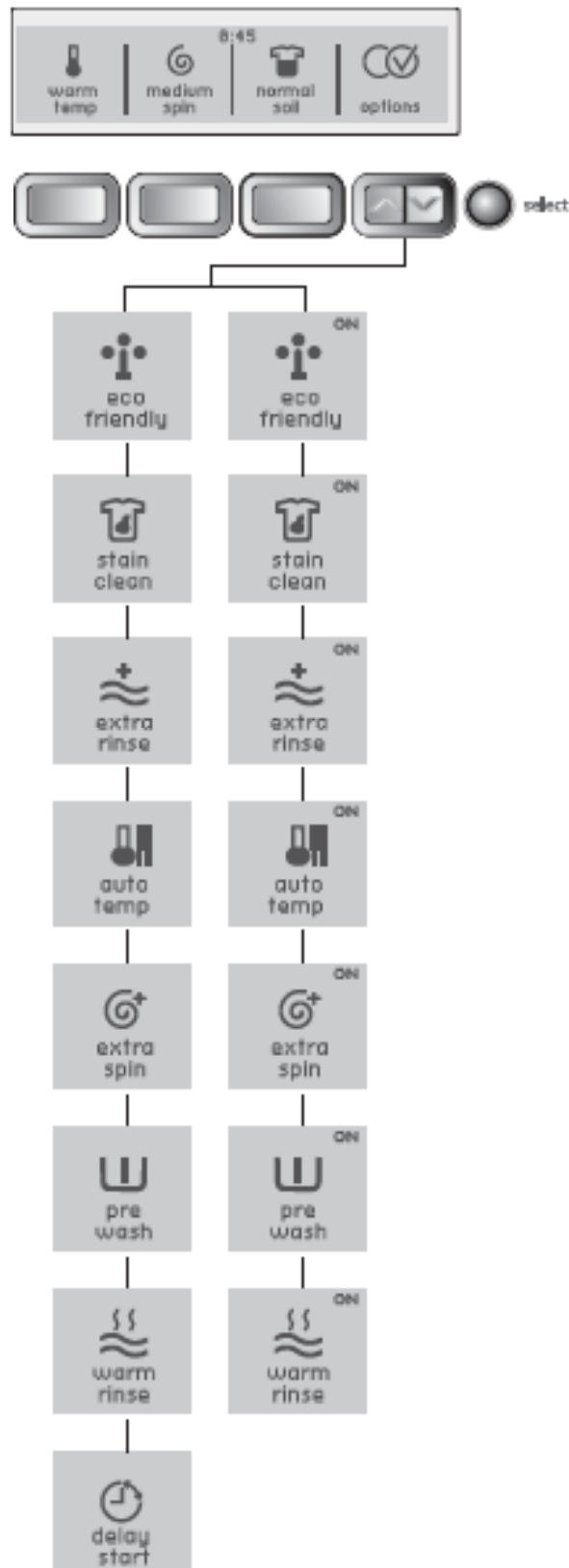

Options, con't

DELAY START

Use delay start to select a wash time convenient to your schedule or during off-peak energy hours. The start of any cycle can be delayed for 30 minutes to 22 hours. Select the **delay start** option and then press the button under the plus (+) or minus (-) symbols to scroll to the delayed time setting desired. Press the **select** button again and the delay time will be displayed and begin counting down.

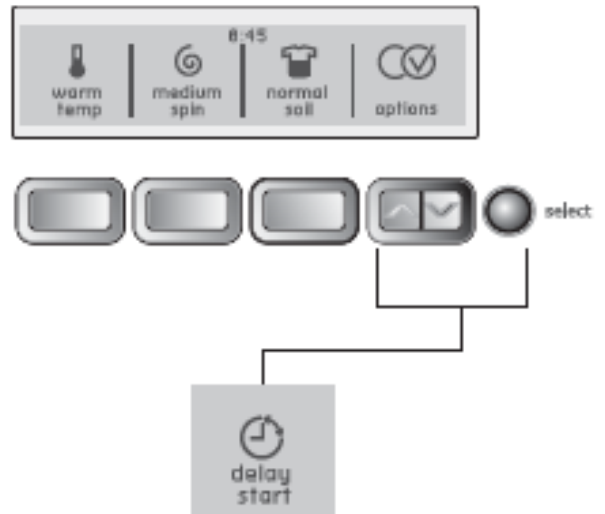

User Interface Features

SAVE AS FAVORITE

The **save as favorite** feature allows you to personalize up to 3 custom cycles each custom user. See **save as favorite** in "Operating User Interface Preferences" for more details.

SET PREFS

The **set prefs** feature allows you to personalize cycles, hide cycle descriptions, select the language, volume, brightness and contrast of the display, reset settings, clean the washer, and run the installation cycle. See **SET PREFS** in "Operating User Interface Features" for more details.

USER GUIDES

Scroll through this option for the **CYCLES GUIDE**, **SETTINGS GUIDE**, **OPTIONS GUIDE**, and **SET PREFS GUIDE** for descriptions of the cycles, water temperatures, spin speeds, soil levels, cycle options and features for user preferences.

STAIN GUIDES

Scroll through the **stain guide** to the desired stain category. Press the **select** button for safe, successful stain removal instructions or consult the "Stain Removal" section in this guide.

CONTROL LOCK

To lock the controls between cycles, scroll to the control lock feature, press **select** and **CONTROL LOCK OFF** - press **SELECT** to lock the control panel will be displayed. Press the **select** button to lock the controls. To unlock the controls, press and hold **select** again for 3 seconds. Use this feature to reduce the likelihood of accidental operation by children.

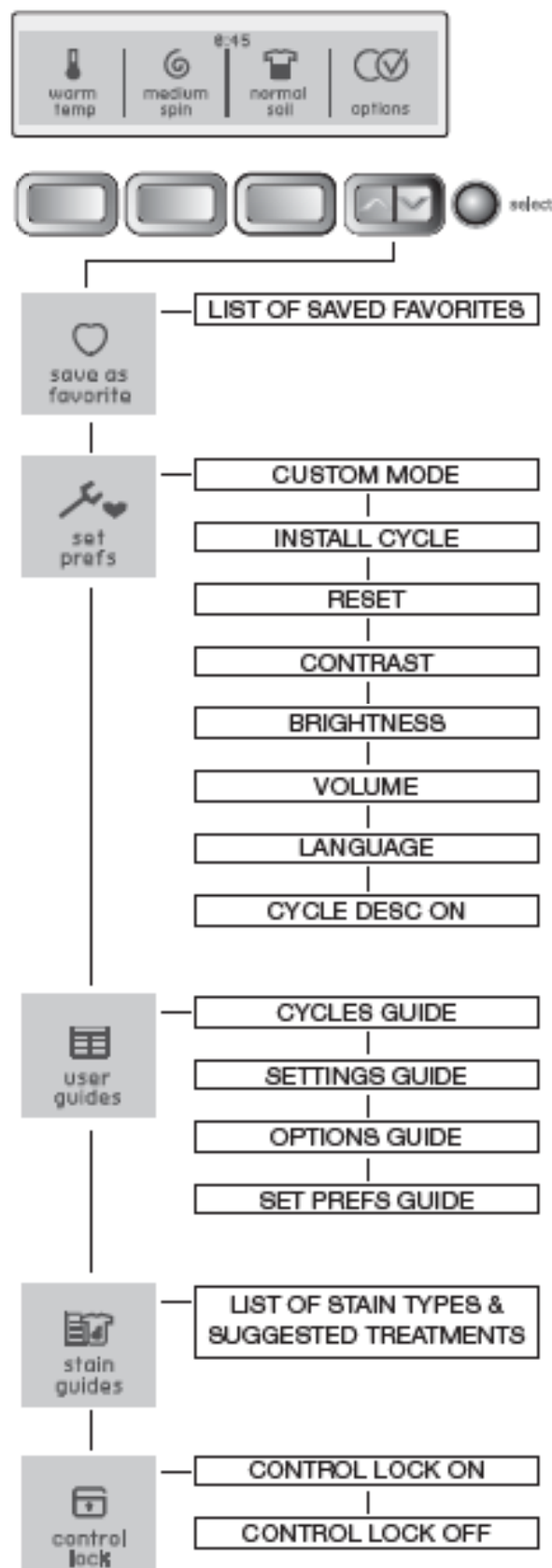

Saving Favorites

Use the **save as favorite** feature to name and save a custom cycle to memory with all options and settings preferred. Up to 3 favorites may be saved for each custom user. Follow these steps:

- Select a cycle, washing temperature, spin speed, soil level and other options desired.
- Use the scroll up or scroll down button until you reach **save as favorite**.
- Press the **select** button to enter the favorite cycle choice screen.
- Choose 1 of the 3 buttons for naming the cycle.
- See the next page for naming your favorite cycle.

For example, to customize the **normal** cycle for your shirt loads with a warm water wash, medium final spin speed and normal soil level:

- Turn the cycle selector knob to **normal**.
- Press the **temp** button to select **warm temp**.
- Press the **spin speed** button to select **medium spin speed**.
- Press the **soil level** button to select **normal soil**.
- Press the scroll up or scroll down button until you reach **save as favorite**.
- Press the **select** button to enter the favorite cycle choice screen.
- Press the button under **my favorite 1**.
- See the next page for naming your favorite cycle.

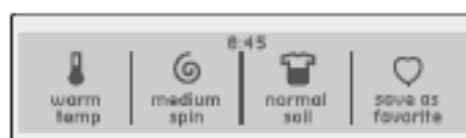

Saving Favorites, con't

To name the customized cycle for shirts, press **my favorite 1**.

Press the button under **ABC** to name the favorite cycle alphabetically. Use the button under **1A#** to add numbers, foreign language characters or symbols to the name.

Rotate the cycle selector knob in either direction to select the letters **S-H-I-R-T-S**, pausing after each character to let the cursor advance. Press the button under **DELETE** to erase incorrect entries. There is a blank character between **z** and **A** for inserting spaces in your custom name. Pause momentarily on this character as you would to insert any other character, then continue.

Press **select** to save the favorite cycle name.

Repeat the steps to customize 2 other cycles as **my favorite 2** and **my favorite 3**. Any of the favorite cycle names can be changed in the future by turning the cycle selector knob to **my favorites** and pressing the button under **EDIT NAMES**.

See **my favorites** in the "Cycle Selection" section of this guide for instructions on using your customized cycles.



Setting Preferences

CUSTOM MODE

CUSTOM MODE allows up to 3 household members to personalize up to 3 favorite cycles each.

To enter custom users and personalize favorite cycles:

- Use the scroll up or scroll down buttons until you reach **set prefs**. Press the **select** button to enter the preference menu.
- Press **select** again to enter **CUSTOM MODE**.
- Press the button for **user 1**, **user 2** or **user 3**.
- Press **select**.

Press the button under **ABC** to name the favorite cycle alphabetically. Use the button under **1A#** to add numbers, foreign language characters or symbols to the name.

Rotate the cycle selector knob in either direction to select the characters in the name, pausing after each character to let the cursor advance. Press the button under **DELETE** to erase incorrect entries. There is a blank character between **Z** and **A** for inserting spaces in your custom name. Pause momentarily on this character as you would to insert any other character, then continue.

When the name has been entered, press **select** to save the name.

To edit names while in **CUSTOM MODE**, turn the washer off by pressing **cancel**. Press any other button to wake the washer up. Screen will display **to change or turn off USERS press SELECT**. You must press **select** within 5 seconds or washer will return to normal operation with previous user selected. After pressing **select** you have the choice of **change users**, **edit names**, **turn off** or **EXIT**. Make your selection and follow the directions displayed.

Each custom user may select up to 3 favorite cycles. The dryer will remember cycle settings, options, preferences, etc. for each user. This allows each user to customize without the hassle of selecting all items each time.



Setting Preferences, con't

INSTALL CYCLE

Run the **INSTALL CYCLE** before operating the washer the first time. Remove all items from the washer drum and press **start**. For more information on performing the washer **INSTALL CYCLE**, refer to the *Installation Instructions* accompanying this washer.

If the washer has been installed according to *Installation Instructions*, **INSTALL PASSED - DOOR CAN BE OPENED** will be displayed and the washer is ready to use.

If the washer was not installed properly, **NO WATER - OPEN WATER VALVES, WATER HOSES - CHECK WATER HOSES** or **CALL SERVICE 877 435 3287** will be displayed to indicate the installation error.

The errors may result from the following conditions:

- **NO WATER** —Water inlet hoses have not been attached to water supply or water supply valves have not been turned on. Install hoses correctly and turn on water supply valves.
- **CHECK HOSES** — The hot inlet hose may have been connected to the cold water supply and the cold inlet hose may have been connected to the hot water supply. Check hoses for correct supply connection. If incorrect, disconnect hoses and connect to correct inlets according to *Installation Instructions*.
- **CALL SERVICE 877 435 3287**—Error can only be corrected by calling a qualified technician (1-877-435-3287).

Repeat the **INSTALL CYCLE** when corrections are completed.

NOTE

The **INSTALL CYCLE** is prompted automatically only once when the washer is turned on the first time at the end of installation. After that, if you wish to run a subsequent **INSTALL CYCLE** when moving the washer or modifying your installation, you may perform your own **INSTALL CYCLE** by selecting it in the **set prefs** feature and then following the screen prompts.



Setting Preferences, con't

SYSTEM CLEAN

To clean and freshen the washer, perform the **SYSTEM CLEAN** cycle. If you wish to begin the cycle, press **select** when prompted. The next screen will instruct you to remove all items from the wash drum, fill the bleach dispenser and press **start**. This maintenance cycle uses hot water and two rinses to remove residue that may cause odor.



NOTE

The washer will automatically prompt you to run the **SYSTEM CLEAN** cycle every 50 cycles. You may press the button under **EXIT** to manually perform the cycle at another time.

RESET

Press the buttons indicated to restore only cycle settings, reset only factory preferences (users, language, brightness, volume, etc.) or restore all factory defaults (both cycle settings and factory preferences). Press the button under **EXIT** to return to normal operation or press the **cancel** button to turn the dryer off without making any changes. If you do not make a selection within 30 seconds the dryer will return to normal operation without any changes. If you reset all settings, **INSTALL CYCLE** will be displayed as though the dryer were just turned on for the first time. You may press the button under **CANCEL** if you do not wish to rerun the **INSTALL CYCLE**.

CONTRAST

Press the button beneath plus (+) or minus (-) symbols to increase or decrease the contrast of the display. Press **select** to accept the change or press the button under **EXIT** to return to normal operation without any changes.



Setting Preferences, con't

BRIGHTNESS

Press the button beneath the plus (+) or minus (-) symbols to increase or decrease the brightness of the display. Press **select** to accept the change or press the button under **EXIT** to return to normal operation without any changes.



VOLUME

Press the button beneath the plus (+) or minus (-) symbols to increase or decrease the volume of the chime. Press **select** to accept the change or press the button under **EXIT** to return to normal operation without any changes.

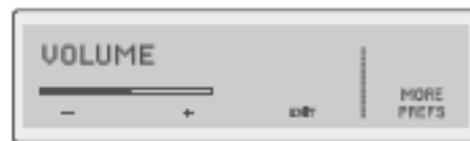

LANGUAGE

Select English, French or Spanish for the display language.



CYCLE DESCRIPTION

The name, an icon and a brief description are displayed for each cycle. To delete the display, press **select**. To restore the display, press **select** and **CYCLE DESC ON** - press **SELECT** to turn OFF will appear in the LCD User Interface.



Other Features

STATUS DISPLAY

The estimated total cycle time will be displayed when the cycle is selected. The time may increase if water pressure is low, oversudsing occurs or the load becomes unbalanced. The approximate time remaining will be displayed during the cycle.

A situation where oversudsing has been detected by the washer will result in the washer automatically adding up to 4 extra rinses to attempt to clear the suds. Each extra rinse the washer performs to clear the suds will add 5 minutes to the cycle display time. If an excessive amount of detergent has been added and additional rinsing has not corrected the issue, **TOO MUCH DETERGENT** will be displayed.

DRUM LIGHT

The drum light will come on whenever the door is opened to illuminate the drum during loading and unloading. Closing the door turns off the light. The drum light will automatically turn off if the door is left open more than 3 minutes.

To activate the drum light during a cycle, press the button under **LIGHT**. The light will stay on during the cycle for 3 minutes. To turn it off, press the button under **LIGHT** again.

REVERSIBLE DOOR

Your washer is equipped with a reversible door. The door can be hinged on the right or left side.

NOTE

For step-by-step instructions on **DOOR REVERSAL**, refer to the *Installation Instructions* supplied with this washer.



STATUS DISPLAY

The following will also be displayed at the appropriate times during the cycle:

DOOR LOCKED
FILLING..
PREWASHING..
WASHING... DOOR LOCKED
RINSING... DOOR LOCKED
DRAINING... DOOR LOCKED
SPINNING... DOOR LOCKED
COMPLETE - DOOR CAN BE OPENED

Washer Settings Chart

These temperature, spin speeds, soil levels and options are available with the following cycles:

	deep clean sanitize 	heavy duty 	whites 	colors 	normal 	casual 	active wear 	fast wash 	delicate 	hand wash 	spin only
Estimated Cycle Duration**	144 min	57 min	62 min	31 min	52 min	31 min	36 min	18 min	31 min	31 min	08 min

temperature

sanitize	✓*										
hot		✓	✓*		✓	✓		✓			
eco hot		✓	✓		✓	✓		✓			
warm		✓*		✓	✓*	✓*	✓*	✓*	✓	✓	
eco warm		✓		✓	✓	✓	✓	✓	✓	✓	
cold		✓		✓*	✓	✓	✓	✓	✓*	✓*	✓

spin speed

maximum spin	✓*	✓*	✓*	✓	✓*	✓	✓	✓*	✓	✓	✓*
high spin	✓	✓	✓	✓*	✓	✓*	✓*	✓	✓	✓	✓
medium spin	✓	✓	✓	✓	✓	✓	✓	✓	✓*	✓	✓
low spin	✓	✓	✓	✓	✓	✓	✓	✓	✓	✓*	✓
minimum spin	✓	✓	✓	✓	✓	✓	✓	✓	✓	✓	✓
no spin	✓	✓	✓	✓	✓	✓	✓	✓	✓	✓	✓

soil level

heaviest soil	✓	✓	✓	✓	✓	✓	✓				
xtra heavy soil	✓	✓	✓	✓	✓	✓	✓				
heavy soil	✓	✓	✓	✓	✓	✓	✓				
normal soil	✓*	✓*	✓*	✓*	✓*	✓*	✓*	✓	✓*	✓*	
light soil			✓	✓	✓	✓	✓	✓	✓	✓	
xtra light soil			✓	✓	✓	✓	✓	✓*	✓	✓	

options

delay start	✓	✓	✓	✓	✓	✓	✓	✓	✓	✓	✓
warm rinse		✓			✓		✓	✓	✓	✓	
prewash		✓	✓	✓	✓	✓	✓				
extra spin	✓	✓	✓	✓	✓	✓	✓				
auto temp	✓*	✓*	✓*	✓*	✓*	✓*	✓*	✓*	✓*	✓*	✓*
extra rinse	✓	✓	✓	✓	✓	✓	✓		✓	✓	✓
stain clean		✓	✓	✓	✓	✓	✓		✓		
eco friendly		✓	✓	✓	✓	✓	✓	✓	✓	✓	

* Factory presets

✓ Available selections

**Estimated cycle duration is based on factory settings and does not include water fill times, out-of-balance, or oversudsing conditions.

Stain Removal Procedures

SAFE STAIN REMOVAL PROCEDURES

To reduce the risk of fire or serious injury to persons or property, comply with the basic warnings listed below:

- Read and comply with all instructions on stain removal products.
- Keep stain removal products in their original labeled containers and out of children's reach.
- Thoroughly wash any utensils used.
- Do not combine stain removal products, especially ammonia and chlorine bleach. Dangerous fumes can result.
- Never wash items which have been previously cleaned in, washed in, soaked in or spotted with gasoline, dry cleaning solvents or other flammable or explosive substances because they give off vapors that could ignite or explode.
- Never use highly flammable solvents, such as gasoline, inside the home. Vapors can explode on contact with flames or sparks.

FOR SUCCESSFUL STAIN REMOVAL:

- Remove stains promptly.
- Determine the kind of stain, then follow the recommended treatment in the stain removal chart on the next page.
- To pretreat stains, use a prewash product, liquid detergent, or a paste made from powder detergent and water.
- Use cold water on unknown stains because hot water can set stains.
- Consult care label instructions for treatments to avoid on specific fabrics.
- Check for colorfastness by testing stain remover products on an inside seam.
- Rinse and wash items after stain removal.

WARNING

HARMFUL VAPOR HAZARD

Do not use or mix liquid chlorine bleach with other household chemicals such as toilet cleaners, rust removers, acid or products containing ammonia. These mixtures can produce dangerous fumes which can cause serious injury or death.



For best results

Follow the fabric care label instructions on items to be washed.



Stain Removal Suggestions

STAIN	TREATMENT
Adhesive tape, chewing gum, rubber cement	Apply ice. Scrape off excess. Place stain face down on paper towels. Saturate with prewash stain remover or nonflammable dry cleaning fluid.
Baby formula, dairy products, egg	Use product containing enzymes to pretreat or soak stains. Soak for 30 minutes or more. Wash.
Beverages (coffee, tea, soda, juice, alcoholic beverages)	Pretreat stain. Wash using cold water and bleach safe for fabric.
Blood	Rinse with cold water. Rub with bar soap. Or, pretreat or soak with product containing enzymes. Wash using bleach safe for fabric.
Candle wax, crayon	Scrape off surface wax. Place stain face down between paper towels. Press with warm iron until wax is absorbed. Replace paper towels frequently. Treat remaining stain with prewash stain remover or nonflammable dry cleaning fluid. Hand wash to remove solvent. Wash using bleach safe for fabric.
Chocolate	Pretreat or soak in warm water using product containing enzymes. Wash using bleach safe for fabric.
Collar or cuff soil, cosmetics	Pretreat with prewash stain remover or rub with bar soap.
Dye transfer on white fabric	Use packaged color remover. Wash using bleach safe for fabric.
Grass	Pretreat or soak in warm water using product containing enzymes. Wash using bleach safe for fabric.
Grease, oil, tar (butter, fats, salad dressing, cooking oils, car grease, motor oils)	Scrape residue from fabric. Pretreat. Wash using hottest water safe for fabric. For heavy stains and tar, apply nonflammable dry cleaning fluid to back of stain. Replace towels under stain frequently. Rinse thoroughly. Wash using hottest water safe for fabric.
Ink	Some inks may be impossible to remove. Washing may set some inks. Use prewash stain remover, denatured alcohol or nonflammable dry cleaning fluid.
Mildew, scorch	Wash with chlorine bleach if safe for fabric. Or, soak in oxygen bleach and hot water before washing. Badly mildewed fabrics may be permanently damaged.
Mud	Brush off dry mud. Pretreat or soak with product containing enzymes.
Mustard, tomato	Pretreat with prewash stain remover. Wash using bleach safe for fabric.
Nail polish	May be impossible to remove. Place stain face down on paper towels. Apply nail polish remover to back of stain. Repeat, replacing paper towels frequently. Do not use on acetate fabrics.
Paint, varnish	WATER BASED: Rinse fabric in cool water while stain is wet. Wash. Once paint is dry, it cannot be removed. OIL BASED AND VARNISH: Use solvent recommended on can label. Rinse thoroughly before washing.
Perspiration	Use prewash stain remover or rub with bar soap. Rinse. Wash using nonchlorine bleach in hottest water safe for fabric.
Rust, brown or yellow discoloration	Use rust remover safe for fabric. Do not use chlorine bleach because it may intensify discoloration.
Shoe polish	LIQUID: Pretreat with a paste of powder detergent and water. PASTE: Scrape residue from fabric. Pretreat with prewash stain remover or nonflammable dry cleaning fluid. Rinse. Rub detergent into dampened area. Wash using bleach safe for fabric.
Tomato	Pretreat with prewash stain remover. Wash using bleach safe for fabric.
Urine, vomit, mucus, feces	Pretreat or soak in product containing enzymes. Wash using bleach safe for fabric.
Wine	Pretreat or soak in cold water. Wash in hottest water and bleach safe for fabric.

▶ IMPORTANT

DO NOT load garments or other items in the washer when cleaning the inside of the washer.

TO REFRESH WASH DRUM

- Perform the **SYSTEM CLEAN** cycle to clean and freshen the washer. To begin the cycle, press **select** when prompted. The next screen will instruct you to remove all items from the wash drum, fill the bleach dispenser and press **start**. This maintenance cycle uses hot water and two rinses to remove residue that may cause odor.

🗨️ NOTE

The washer will automatically prompt you to run the **SYSTEM CLEAN** cycle every 50 cycles. You may press the button under **EXIT** to manually perform the cycle at another time.

OTHER INSIDE CLEANING

- Before cleaning the washer interior, unplug the electrical power cord to avoid electrical shock hazards.
- Dry around the washer door opening, flexible gasket, and door glass. These areas should always be clean to ensure a water tight seal.
- When extremely soiled items have been washed, a dirty residue may remain on the drum. Remove this by wiping the drum with a nonabrasive household cleanser. Rinse thoroughly with water.
- Periodically, wipe dry the folds in the bottom of the flexible gasket to remove lint and other debris.
- The drum vanes may become stained from fabric dye. Clean these parts with a nonabrasive household cleanser to prevent dye transfer to future loads.

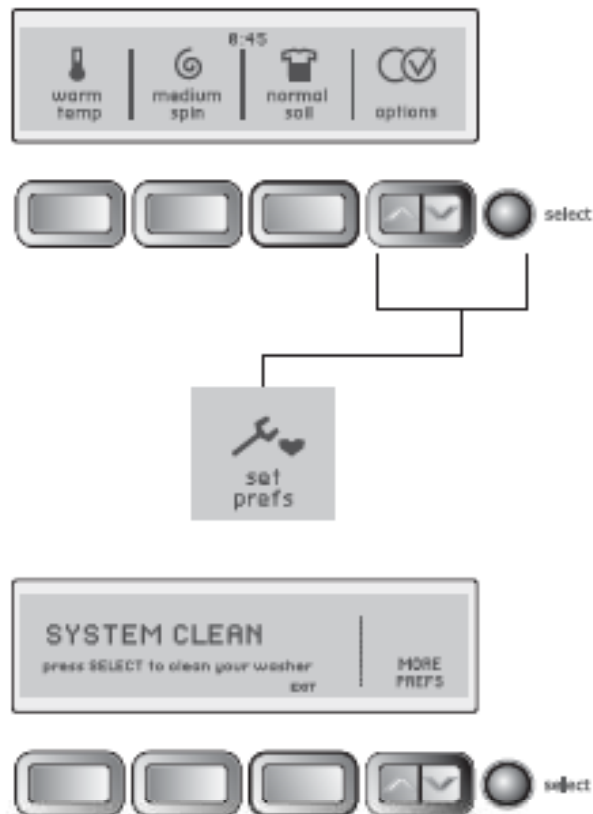

 **NOTE**

Detergent and fabric softener may build up in the dispenser drawer. Residue should be removed once or twice a month.

CLEANING DISPENSER DRAWER AREA

- Remove the drawer by pulling the drawer out until it stops.
- Reach back into the left rear corner of the drawer cavity and press down firmly on the lock tab. Pull out the drawer.
- Remove the insert from the prewash, bleach, and fabric softener compartments.
- Rinse the drawer and inserts with hot tap water to remove traces of accumulated powders and liquids. Large amounts of fabric softener residue may indicate improper dilution or more frequent cleaning is required.
- To clean the drawer opening, use a small brush to clean the recess. Remove all residue from the upper and lower parts of the recess.
- Replace the insert by pressing it in place until you hear a slight click. Return the dispenser drawer.

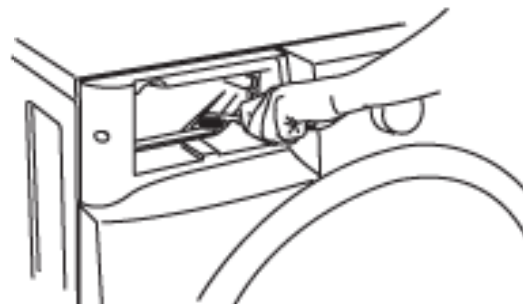
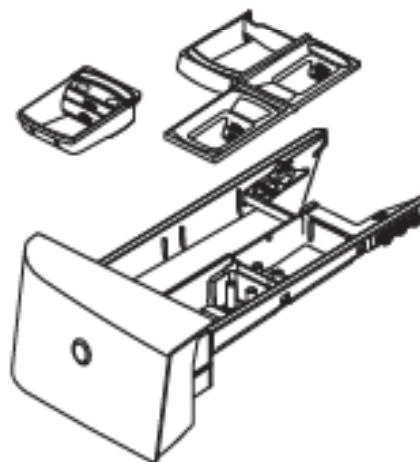
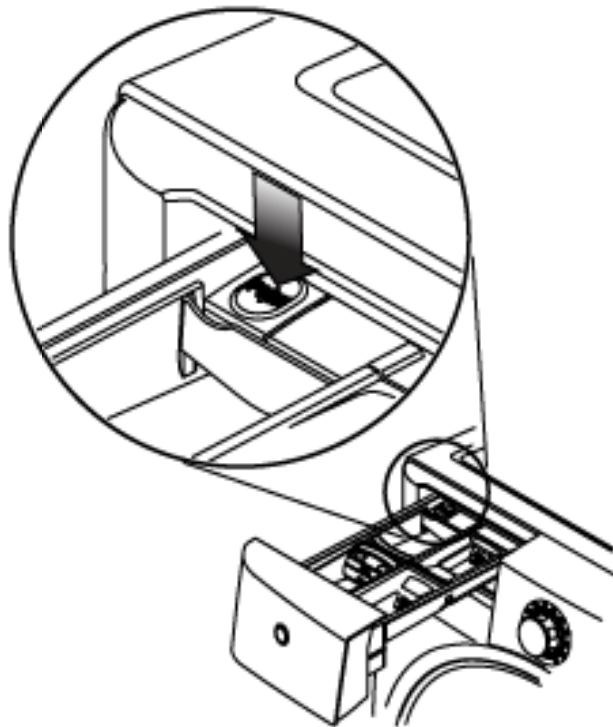

OUTSIDE

- When washing is completed, wipe top and sides of washer with a damp cloth. Turn water faucets off to prevent pressure build-up in the hoses.
- Clean the cabinet with mild soap and water. Never use harsh, gritty or abrasive cleansers.
- If the cabinet becomes stained, clean with diluted chlorine bleach (1 part bleach to 8 parts water). Rinse several times with clear water.
- Remove glue residue from tape or labels with a mixture of warm water and mild detergent. Or, touch residue with the sticky side of tape.
- When cleaning chrome parts use a window cleaner with ammonia or mild soap and water.
- Before moving the washer, place a strip of cardboard or thin fiberboard under the front leveling legs to prevent damage to the floor.

**→ IMPORTANT**

If the washer is stored in an area where freezing can occur or moved in freezing temperatures, follow these winterizing instructions to prevent damage to the washer.

→ IMPORTANT

Do not store or place laundry products on top of washer at any time. They can damage the finish or controls.

WINTERIZING INSTRUCTIONS

1. Turn off water supply faucets.
2. Disconnect hoses from water supply and drain water from hoses.
3. Plug electrical cord into a properly grounded electrical outlet.
4. Add 1 gallon (3.8 L) nontoxic recreational vehicle (RV) antifreeze to empty wash drum. Close door.
5. Select the **spin only** cycle. Press **start** and let the washer drain for 1 minute to drain out all the water. Not all of the RV antifreeze will be expelled.
6. Press **cancel**, unplug electrical power cord, dry off drum interior and close door.
7. Remove dispenser drawer. Drain any water in compartments and dry compartments. Replace drawer.
8. Store washer in an upright position.
9. To remove antifreeze from washer after storage, run empty washer through a complete cycle using detergent. Do not add wash load.



Follow **WINTERIZING INSTRUCTIONS** for cold weather storage and care.



Common Washing Problems

Many washing problems involve poor soil and stain removal, residues of lint and scum, and fabric damage. For satisfactory washing results, follow these suggestions provided by The Soap and Detergent Association.

PROBLEM	POSSIBLE CAUSES	SOLUTIONS	PREVENTIVE MEASURES
Blue stains	<ul style="list-style-type: none"> • Undiluted liquid detergent or fabric softener dispensed directly onto fabric. 	<ul style="list-style-type: none"> • If caused by detergent, mix 1 cup (240 ml) white vinegar with 1 quart (.95 L) water in a plastic container. Soak item 1 hour. Rinse. • If caused by fabric softener, rub stains with bar soap. Wash. 	<ul style="list-style-type: none"> • Avoid overfilling detergent and fabric softener compartments of dispenser.
Discoloration, graying	<ul style="list-style-type: none"> • Not enough detergent. • Wash water temperature too low. • Incorrect sorting. 	<ul style="list-style-type: none"> • Rewash with correct amount of detergent and hottest water safe for fabric. • Add bleach safe for fabric. 	<ul style="list-style-type: none"> • Sort items by soil level and color. • Use correct amount of detergent, hottest water and bleach safe for fabric.
Greasy, oily stains	<ul style="list-style-type: none"> • Not enough detergent. • Undiluted liquid fabric softener poured directly on fabric. 	<ul style="list-style-type: none"> • Treat with prewash stain remover or liquid detergent. • Increase detergent and water temperature. Rewash. • Rub fabric softener stains with bar soap. 	<ul style="list-style-type: none"> • Use correct amount of detergent and hottest water safe for fabric. • Do not pour liquid fabric softener directly on fabric. See Operating Your, step 5.
Holes, tears, or snags	<ul style="list-style-type: none"> • Incorrect use of chlorine bleach. • Unfastened zippers, hooks, buckles. • Rips, tears and broken threads. • Overloading the washer. • Degradation of fabric. 	<ul style="list-style-type: none"> • May be irreversible if rips, tears and seams cannot be mended. 	<ul style="list-style-type: none"> • Never pour chlorine bleach directly on fabric. • Check condition of items before washing. See Operating Your, steps 2 and 5.
Lint	<ul style="list-style-type: none"> • Incorrect sorting. • Tissues left in pocket. • Overloading the washer. • Not enough detergent. • Undissolved detergent has left a residue resembling lint. • Static cling is attracting lint. • Load washed too long. 	<ul style="list-style-type: none"> • Reduce load size. Rewash using correct water temperature, water level, and amount of detergent. • Add nonprecipitating water conditioner to wash water to remove detergent residue. • Add liquid fabric softener to final rinse. • Dry load in dryer. • Remove lint with lint brush or roller. 	<ul style="list-style-type: none"> • See Operating Your, steps 1 and 2. • Do not overload washer. • Use correct temperature and amount of detergent, water and wash time.

Common Washing Problems, con't

PROBLEM	POSSIBLE CAUSES	SOLUTIONS	PREVENTIVE MEASURES
Pilling (Fibers ball up and cling to fabric.)	<ul style="list-style-type: none"> Pilling is normal with synthetic and permanent press fabrics. This is due to abrasion from normal wear. 	<ul style="list-style-type: none"> Use a lint brush or shaver to remove pills. 	<ul style="list-style-type: none"> Use fabric softener in the washer to lubricate fibers. When ironing, use spray starch or fabric finish on collars and cuffs. Turn items inside out to reduce abrasion.
Residue or powder on dark items; Stiff, harsh fabrics.	<ul style="list-style-type: none"> Undissolved detergent. Some granular detergents can combine with hard water minerals to form a residue. Overloading the washer. 	<ul style="list-style-type: none"> Rewash load. 	<ul style="list-style-type: none"> Increase water temperature using hottest water safe for fabric. Do not overload washer. Use liquid detergent or use nonprecipitating water conditioner with powder detergent.
Wrinkling	<ul style="list-style-type: none"> Overloading the washer. Incorrect wash cycle for wash load. 	<ul style="list-style-type: none"> Reduce load size. Rinse in cold water with liquid fabric softener using the casual or delicate cycle. 	<ul style="list-style-type: none"> Do not overload washer. Remove items from washer as soon as cycle is completed. Use liquid fabric softener.
Yellow buildup of body soil on synthetic fabrics	<ul style="list-style-type: none"> Agitation time too short. Wash water temperature too low. Not enough detergent. 	<ul style="list-style-type: none"> Soak in detergent booster or product containing enzymes. Wash in hottest water safe for fabric using casual cycle. Increase detergent. Add bleach safe for fabric or treat with color remover. 	<ul style="list-style-type: none"> Select correct wash cycle. Use correct amount of detergent. Wash synthetics frequently using hot or warm water.
Yellow or brown rust stains	<ul style="list-style-type: none"> Iron or manganese in water supply, water pipes, or water heater. 	<ul style="list-style-type: none"> To restore discolored load of whites, use rust remover safe for fabric. Do not use chlorine bleach to remove rust stains. It may intensify discoloration. 	<ul style="list-style-type: none"> Use nonprecipitating water softener. Before washing, run hot water for a few minutes to clear lines. Drain water heater occasionally. For an ongoing problem, install an iron filter in your water supply system.

Service Prevention Checklist

Before calling for service, review this list. It may save both time and expense. The list includes common occurrences that are not the result of defective workmanship or materials in this washer.

OCCURRENCE	POSSIBLE CAUSE	SOLUTION
NOISE		
High pitch "jet engine" noise.	A certain amount of motor whine is normal during the spin cycle.	
Rattling and clanking noise.	Foreign objects such as coins or safety pins may be in drum or pump.	Stop washer and check drum. If noise continues after washer is restarted, objects may be in pump. Call your authorized servicer.
	Belt buckles and metal fasteners are hitting wash drum.	To prevent unnecessary noise and damage to drum, fasten fasteners and turn items inside out.
Thumping sound.	Heavy wash loads may produce a thumping sound. This is usually normal. If sound continues, washer is probably out of balance.	Stop washer and redistribute wash load.
Vibrating noise.	Washer is not resting firmly on floor.	Move washer so it rests firmly on floor. Adjust leveling legs. See INSTALLATION INSTRUCTIONS for details.
	Shipping bolts and foam block have not been removed during installation.	See INSTALLATION INSTRUCTIONS for removing shipping bolts and foam block.
	Wash load unevenly distributed in drum.	Stop washer and rearrange wash load.
OPERATING		
Washer does not start.	Electrical power cord may not be plugged in or connection may be loose.	Make sure plug fits tightly in wall outlet.
	House fuse blown, circuit breaker tripped, or a power outage has occurred.	Reset circuit breaker or replace fuse. Do not increase fuse capacity. If problem is a circuit overload, have it corrected by a qualified electrician. If problem is a power outage, call local electric company.
	Water supply faucets are not turned on.	Turn on water supply faucets.
	Motor is overheated. Washer motor will stop if it becomes overheated.	It will automatically restart after a cool down period of up to 30 minutes (if washer has not been manually turned off).
	Washer door is not completely closed.	Close door completely.
Washer won't spin.	Load is too small.	Add 1 or 2 similar items to help balance the load.
Residue left in drum.	Heavily soiled items.	Wipe drum with a nonabrasive household cleanser, then rinse. Shake or brush excess dirt and sand from items before washing.
LCD displays demo mode.	Washer has been programmed to temporarily perform a repeating demo cycle.	To return to the factory default settings, select RESET in set prefs under the options scroll buttons.

Avoid Service Checklist, con't

OCCURRENCE	POSSIBLE CAUSE	SOLUTION
WATER		
Water collects in folds of the bellows at the end of the cycle.	This is a result of the washing action and is part of the normal operation of the washer.	
Water collects in bleach and fabric softener compartments.	This is a result of the siphoning action and is part of the normal operation of the washer.	Water may be removed by removing the dispenser drawer (see Care and Cleaning in this guide) and draining water into the empty drum or sink.
Wash load too wet after spin.	Washer is overloaded.	Do not overload washer. See Operating Your Washer, step 4.
	Load is too small.	Add 1 or 2 similar items to help balance the load.
	Load is out of balance.	Rearrange load to allow proper spinning.
	Drain hose is kinked.	Straighten drain hose.
Water does not enter washer or it enters slowly.	Water supply is not adequate in area.	Check another faucet in the house. Wait until water supply and pressure increase.
	Water supply faucets are not completely open.	Fully open hot and cold faucets.
	Water is being used elsewhere in the house. Water pressure must be at least 30 psi (200 kPa).	Avoid running water elsewhere while washer is filling.
	Water inlet hoses are kinked.	Straighten hoses.
Warm or hot water is not hot enough.	Hot water heater is set too low or is a distance from washer.	Measure hot water temperature at nearby faucet with candy or meat thermometer. Water temperature should be at least 120°F (49°C). Adjust water heater as necessary.
	Hot water is being used elsewhere in the house.	Avoid using hot water elsewhere before or during washer use. There may not be enough hot water available for proper cleaning. If problem persists, your hot water system may be unable to support more than 1 use at a time.
Water in washer does not drain or drains slowly.	Drain hose is kinked or clogged.	Clean and straighten the drain hose.
	Drain hose standpipe is too tall. Maximum standpipe height is 8' (2.4 m).	Reduce standpipe height to less than 8' (2.4 m). See INSTALLATION INSTRUCTIONS.
	House drain pipes are clogged.	Unclog drain pipes. Contact plumber if necessary.
Water leaks.	Fill hose connection is loose at faucet or washer.	Check and tighten hose connections. Install rubber sealing washers provided.
Oversudsing.	Wrong detergent.	Run rinse cycle. Use a low-sudsing, high efficiency detergent.
	Too much detergent.	Run rinse cycle. Use less detergent in future loads.
Incorrect wash and rinse temperatures.	Hot and cold water hoses are connected to wrong supply faucets.	Connect hot water hose to hot water faucet and cold water hose to cold water faucet.
Water is entering washer but tub does not fill.	Drain hose standpipe is too low. Standpipe must be a minimum of 23.6" (60 cm) high to prevent siphoning.	Increase standpipe height to at least 23.6" (60 cm). See INSTALLATION INSTRUCTIONS.

Your appliance is covered by a one year limited warranty. For one year from your original date of purchase, Electrolux will repair or replace any parts of this appliance that prove to be defective in materials or workmanship when such appliance is installed, used, and maintained in accordance with the provided instructions. In addition, your appliance is covered by an additional one year, parts only, limited warranty. During the 2nd year from your original date of purchase, Electrolux will pay for parts needed for this appliance that have proven to be defective in materials or workmanship when your appliance is installed, used, and maintained in accordance with the provided instructions.

Exclusions

This warranty does not cover the following:

1. Products with original serial numbers that have been removed, altered or cannot be readily determined.
2. Product that has been transferred from its original owner to another party or removed outside the USA or Canada.
3. Rust on the interior or exterior of the unit.
4. Products purchased "as-is" are not covered by this warranty.
5. Products used in a commercial setting.
6. Service calls which do not involve malfunction or defects in materials or workmanship, or for appliances not in ordinary household use or used other than in accordance with the provided instructions.
7. Service calls to correct the installation of your appliance or to instruct you how to use your appliance.
8. Expenses for making the appliance accessible for servicing, such as removal of trim, cupboards, shelves, etc., which are not a part of the appliance when it is shipped from the factory.
9. Service calls to repair or replace appliance light bulbs, air filters, water filters, other consumables, or knobs, handles, or other cosmetic parts.
10. Pickup and delivery costs; your appliance is designed to be repaired in the home.
11. Surcharges including, but not limited to, any after hour, weekend, or holiday service calls, tolls, ferry trip charges, or mileage expense for service calls to remote areas, including the state of Alaska.
12. Damages to the finish of appliance or home incurred during transportation or installation, including but not limited to floors, cabinets, walls, etc.
13. Damages caused by: services performed by unauthorized service companies; use of parts other than genuine Electrolux parts or parts obtained from persons other than authorized service companies; or external causes such as abuse, misuse, inadequate power supply, accidents, fires, or acts of God.

DISCLAIMER OF IMPLIED WARRANTIES; LIMITATION OF REMEDIES

CUSTOMER'S SOLE AND EXCLUSIVE REMEDY UNDER THIS LIMITED WARRANTY SHALL BE REPAIR OR REPLACEMENT AS PROVIDED HEREIN. CLAIMS BASED ON IMPLIED WARRANTIES, INCLUDING WARRANTIES OF MERCHANTABILITY OR FITNESS FOR A PARTICULAR PURPOSE, ARE LIMITED TO ONE YEAR OR THE SHORTEST PERIOD ALLOWED BY LAW, BUT NOT LESS THAN ONE YEAR. ELECTROLUX SHALL NOT BE LIABLE FOR CONSEQUENTIAL OR INCIDENTAL DAMAGES SUCH AS PROPERTY DAMAGE AND INCIDENTAL EXPENSES RESULTING FROM ANY BREACH OF THIS WRITTEN LIMITED WARRANTY OR ANY IMPLIED WARRANTY. SOME STATES AND PROVINCES DO NOT ALLOW THE EXCLUSION OR LIMITATION OF INCIDENTAL OR CONSEQUENTIAL DAMAGES, OR LIMITATIONS ON THE DURATION OF IMPLIED WARRANTIES, SO THESE LIMITATIONS OR EXCLUSIONS MAY NOT APPLY TO YOU. THIS WRITTEN WARRANTY GIVES YOU SPECIFIC LEGAL RIGHTS. YOU MAY ALSO HAVE OTHER RIGHTS THAT VARY FROM STATE TO STATE.

If You Need Service

Keep your receipt, delivery slip, or some other appropriate payment record to establish the warranty period should service be required. If service is performed, it is in your best interest to obtain and keep all receipts. Service under this warranty must be obtained by contacting Electrolux at the addresses or phone numbers below.

This warranty only applies in the USA, Puerto Rico and Canada. In the USA and Puerto Rico, your appliance is warranted by Electrolux Major Appliances North America, a division of Electrolux Home Products, Inc. In Canada, your appliance is warranted by Electrolux Canada Corp. Electrolux authorizes no person to change or add to any obligations under this warranty. Obligations for service and parts under this warranty must be performed by Electrolux or an authorized service company. Product features or specifications as described or illustrated are subject to change without notice.

USA
1-877-435-3287
Electrolux Major Appliances North America
North America
P.O. Box 212378
Augusta, GA 30907

Canada
1-800-265-8352
Electrolux Canada Corp.
5855 Terry Fox Way
Mississauga, Ontario, Canada
L5V 3E4