

Induction Built-In Range

EW30IS65JS

Featuring Wave-Touch® Controls & Induction Cooktop



More Energy-Efficient

Cooking with induction is 70% more efficient than gas and 20% more efficient than electric.



More Responsive

Cooking with induction is more responsive than gas or electric — you can instantly adjust the heat to a delicate simmer or bring it to a quick boil.



Exceptional Temperature Control

Adjust heat with greater accuracy than gas or electric cooktops, especially at lower settings. Perfect for melting chocolate and cooking delicate foods and sauces.



Cooking Flexibility

The sensors automatically detect the presence of magnetic cookware, activate the induction field and adjust it to the exact size of the pan.

30" INDUCTION BUILT-IN RANGE

Control Panel Features

Wave-Touch® Electronic Oven Control	Yes
Perfect Set® Element Controls	Yes
Keypad Entry of Time & Temperature	Yes
Electronic Clock & Timer	Yes
Temperature Display	Yes
Automatic Oven (Delay, Cook & Off)	Yes

Induction Cooktop Features

Ceramic Glass Smoothtop	Yes
10" Induction Cooking Element – 2500W/3400W	1
8" Induction Cooking Element – 2400W/3400W	1
7" Induction Cooking Element – 1900W/2600W	1
6" Induction Cooking Element – 1500W/1900W	1
Hot-Surface Indicator Light	Yes
Surface Controls	Yes

Oven Features

Capacity	4.2 Cu. Ft.
Hidden Bake Element	Yes
Eight-Pass Bake Element – 2500 Watts	Yes
Eight-Pass Broil Element – 4000 Watts	Yes
Convection Element – 2500 Watts	Yes
Cobalt Blue Interior	Yes
Self-Clean Options with Door Lock	3
Perfect Convection ³ with Variable 2-Speed Fan	Yes
Cooking Modes – Bake, Broil, Convection Bake, Convection Roast, Convection Broil, Keep Warm, Slow Cook	7
Baking Options – Perfect Turkey®, Defrost, Dehydrate, Bread Proof, My Favorites, Multi-Stage Cooking, Temperature Probe, Rapid Preheat, Delay Bake, Convection Convert	10
Luxury-Design® Lighting with Dual 40W Halogen Bulbs	Yes
Luxury-Glide® Racks	2
Conventional Racks	1
Convection Roasting Rack	Yes

Additional Features

Luxury-Hold™ Oven Door	Yes
Extra-Large Glass Window	Yes
Perfect Pair Lower Oven®	Yes
Adjustable Leveling Legs	Yes
Sabbath Mode (Star-K® Certified)	Yes
A.D.A. Compliant*	Yes

Accessories

Porcelain Broiler Pan and Insert	Included
Cleaning Sponge	Included
2" Rear Filler Kit, Side Panel Kit, Backguard Kit, Side Trim Kit – See Back for Part Numbers	Optional

Specifications

Color – Stainless Steel	S
Oven Cavity Dimensions –	
Height	16-1/2"
Width	24-1/8"
Depth	18-1/32"
Product Dimensions –	
Height (Adjustable)	35-5/8" – 36-5/8"
Width	30"
Depth (to Center of Arc) (with 90° Door Open)	28-5/16" 45-1/2"
Power Supply Connection Location	Left Bottom Rear
Connected Load (kW Rating) @ 240/208 Volts	13.2/9.9
Amps @ 240/208 Volts	55/48
Minimum Circuit Required (Amps)	50
Shipping Weight (Approx.)	258 Lbs.

*When properly installed, this model is A.D.A.-qualified based on the United States Access Board's A.D.A./A.B.A. Accessibility Guidelines and the Department of Justice's 2010 A.D.A. Standards for Accessible Design.

NOTE: Always consult local and national electric codes. Refer to Product Installation Guide for detailed installation instructions on the web at electroluxappliances.com. Specifications subject to change.

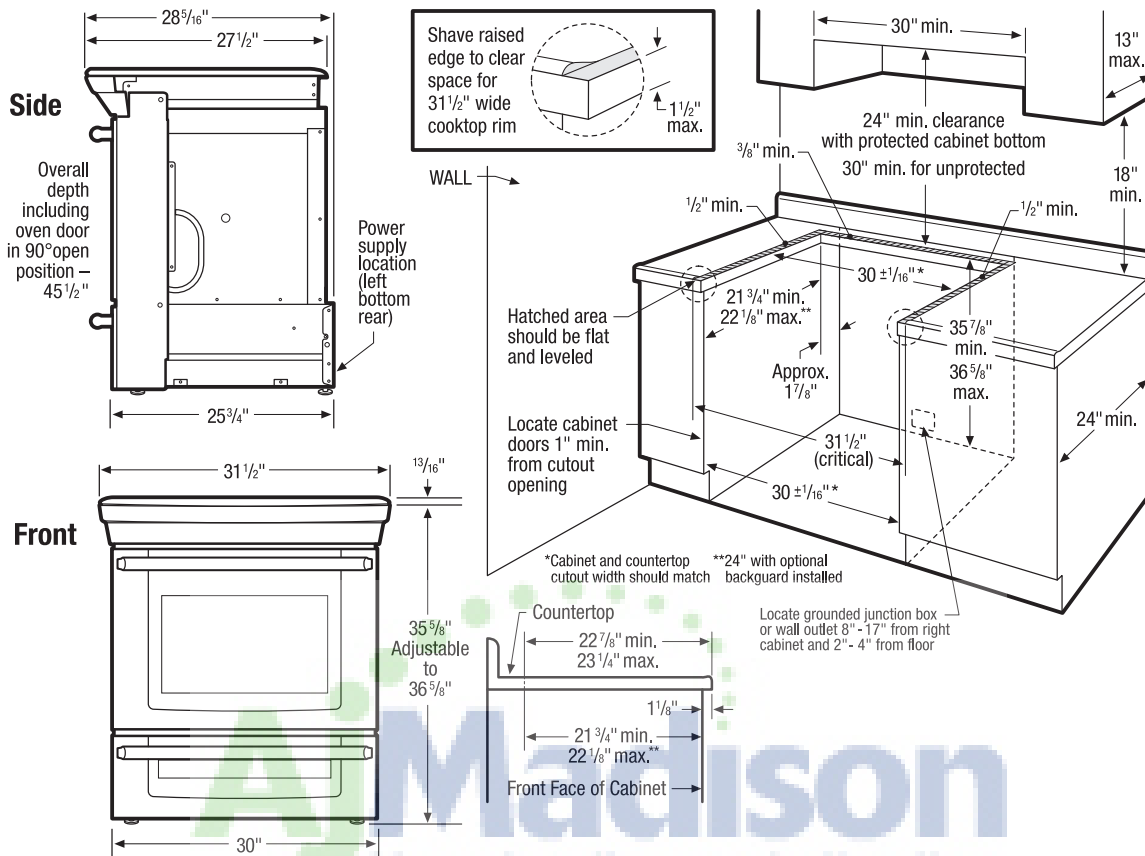

30" Induction Built-In Range Specifications

- Product Weight – 238 Lbs.
- Single phase 3- or 4-wire cable, 120/240 or 120/208 Volt, 60 Hertz, fused on both sides of line with ground. (if local code permits, range may be connected by hard-wiring or by means of power supply cord kit.)
- Connected Load (kW Rating) @ 240/208 Volts = 13.2/9.9 kW
- Amps @ 240/208 Volts = 55/48 Amps
- Recommended Circuit Breaker – 50 Amps
- Always consult local and national electric codes.
- Make sure wall coverings around range can withstand heat generated by range.
- Linoleum or any other synthetic floor covering located beneath range, must be capable of withstanding minimum heat of 90° F above room temperature without shrinking, warping or discoloring. Insulating pad or 1/4"-thick plywood required between range and a carpeted floor.
- Countertop MUST be level in all directions and adjustable range height at least 1/16" greater than tallest cabinet height, to ensure metal rangetop flange will fit properly on countertop edge.
- When installing optional Backguard Kit, cutout depth of 21-3/4" minimum / 22-1/8" maximum needs increased to 24".
- Overhead cabinetry should not exceed a 13" maximum depth.
- Absolute minimum horizontal distance between overhead cabinets installed to either side of appliance must be no less than maximum width of appliance.
- Allow 24" minimum clearance between rangetop and bottom of cabinet when bottom of wood or metal cabinet is protected by not less than 1/4" flame-retardant millboard covered with not less than No. 28 MGS sheet steel, 0.015" stainless steel, 0.024" aluminum or 0.020" copper. Allow 30" minimum clearance when cabinet is unprotected.

- To reduce risk of fire when using overhead cabinetry, install range hood that projects horizontally a recommended minimum of 5" beyond bottom of cabinets.
- When installing range into existing cutout depth greater than 22-1/8", optional 2" Rear Filler Kit available.

Countertop Preparation

- For detailed preparation instructions, refer to installation guide on the web.
- Flat square-finish (flat) countertop requires no preparation since rangetop flange lays directly on countertop edge.
 - Formed front-edged countertops require front molded edge to be shaved flat 3/4" from each front corner of opening.
 - Tile countertops may need cut back 3/4" from each front corner of opening and/or rounded edge flattened.
 - For existing cutout width greater than 30-1/16" reduce the 3/4" overlap dimension or for cutout width of 29", replace actual side trim panels with smaller side trim panels, available with optional Side Trim Kit (refer to detailed kit installation instructions).

Note: For planning purposes only. Refer to Product Installation Guide on the web at electroluxappliances.com for detailed instructions.

Optional Accessories

- 2" Rear Filler Kit: S – (PN# 903113-901S).
- Side Panel Kit: S – (PN# 903102-901S).
- Backguard Kit: S – (PN# 903111-901S).
- Side Trim Kit: S – (PN# 903110-901S).

General Installation Guidelines

For Installation with Side-by-Side Refrigerator



Use these dimensions and clearance instructions for planning purposes only. For detailed installation instructions, refer to installation guide, packed with product, or on the web at electroluxappliances.com.

Front

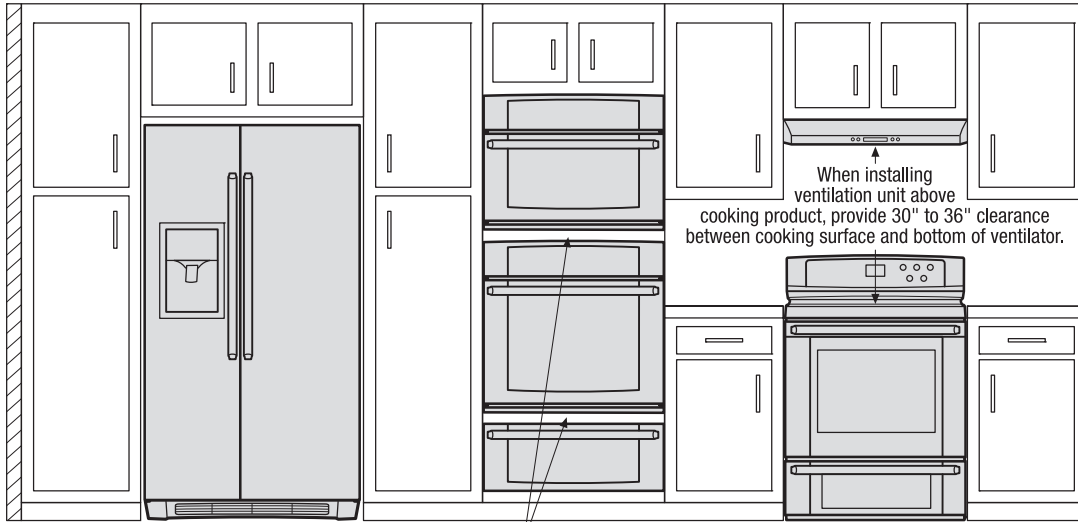

When installing built-in cooking appliances in combination, 2"-high minimum visible gap between appliance faceplates required.

Clearance information for cooking appliances, provided in specific product's installation guide.

Top

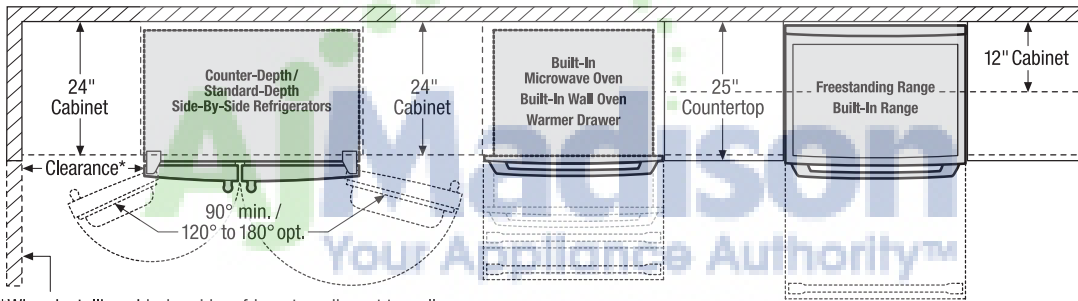

*When installing side-by-side refrigerator adjacent to wall, cabinet or another appliance that extends beyond front edge of unit, 20" minimum clearance recommended to allow for optimum 120° to 180° door swing, providing complete drawer/crisper access and removal. (Absolute 4-1/2" minimum clearance will ONLY allow for 90° door swing which will provide limited drawer/crisper access with restricted removal.)

When installing appliance with sliding drawer or drop-down door directly across from obstructions, provide sufficient clearance for drawer extension or door swing.

Front

To ensure optimum performance, avoid installing refrigeration appliances in direct sunlight or near heat source.

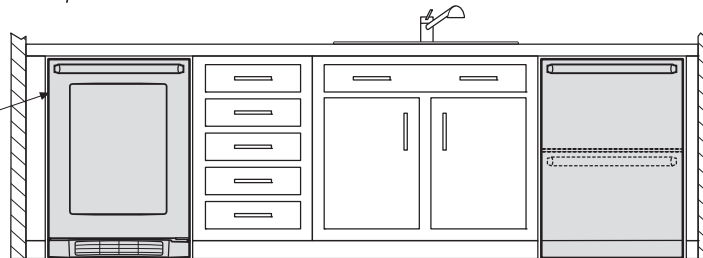

Top

When installing appliance with side-swing door adjacent to wall, cabinet, or other obstruction that extends beyond front edge of appliance, door swing and handle clearance must be sufficient to allow access to appliance interior.

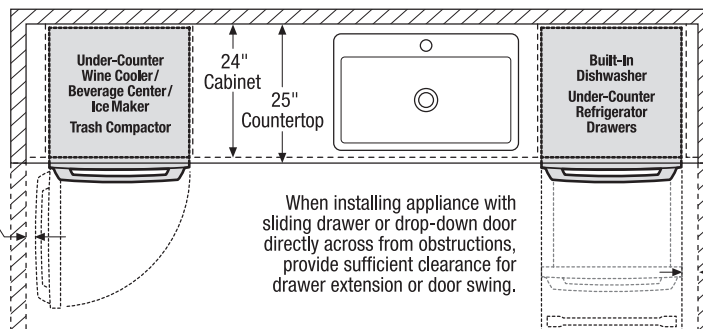

When installing appliance with sliding drawer or drop-down door directly across from obstructions, provide sufficient clearance for drawer extension or door swing.

When installing appliance with sliding drawer or drop-down door adjacent to wall, cabinet, or other obstruction that extends beyond front edge of appliance, allow 2" minimum clearance between drawer or door and obstruction.

Electrolux Major Appliances, N.A.

USA • 10200 David Taylor Drive • Charlotte, NC 28262 • 1-877-4electrolux (1-877-435-3287) • electroluxappliances.com
 CANADA • 5855 Terry Fox Way • Mississauga, ON L5V 3E4 • 1-800-265-8352 • electroluxappliances.ca

General Installation Guidelines

For Installation with French Door Refrigerator



Use these dimensions and clearance instructions for planning purposes only. For detailed installation instructions, refer to installation guide, packed with product, or on the web at electroluxappliances.com.

Front

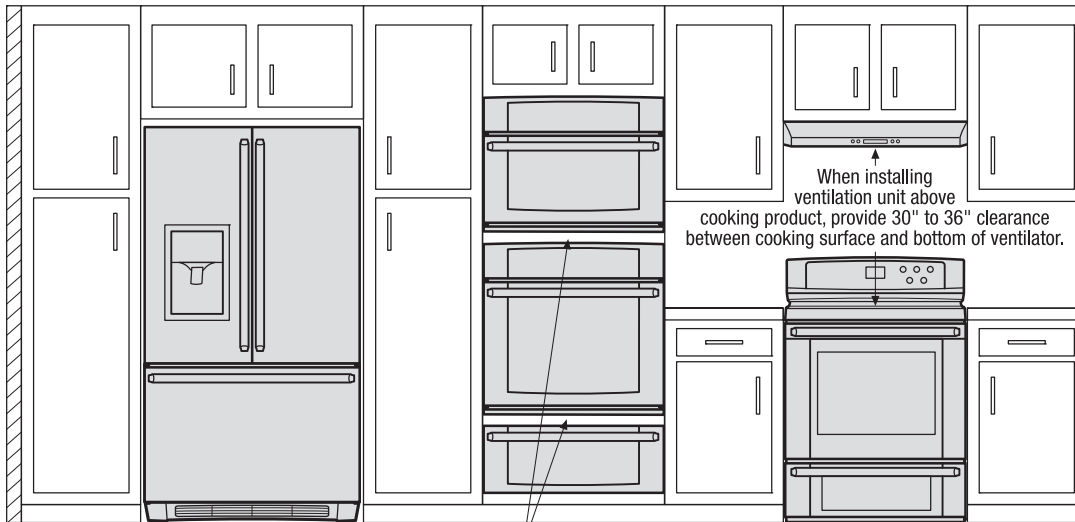

When installing built-in cooking appliances in combination, 2"-high minimum visible gap between appliance faceplates required.

Clearance information for cooking appliances, provided in specific product's installation guide.

Top

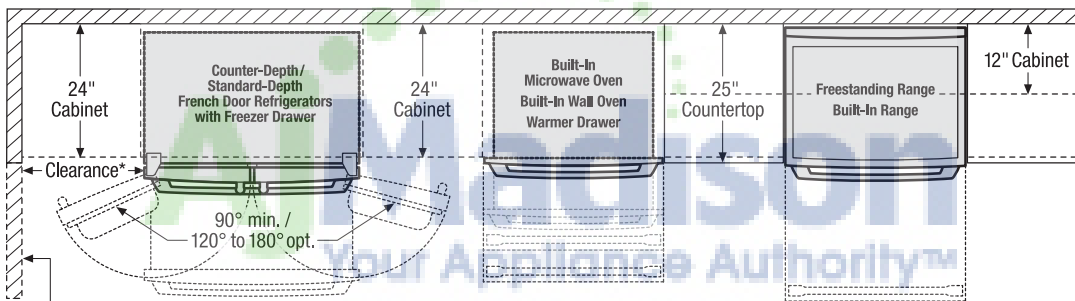

*When installing a French door refrigerator adjacent to wall, cabinet or another appliance that extends beyond front edge of unit, 20" minimum clearance recommended to allow for optimum 120° to 180° door swing, providing complete drawer / crisper access and removal. (Absolute 4-1/2" minimum clearance will ONLY allow for 90° door swing which will provide limited drawer / crisper access with restricted removal.)

When installing appliance with sliding drawer or drop-down door directly across from obstructions, provide sufficient clearance for drawer extension or door swing.

Front

To ensure optimum performance, avoid installing refrigeration appliances in direct sunlight or near heat source.

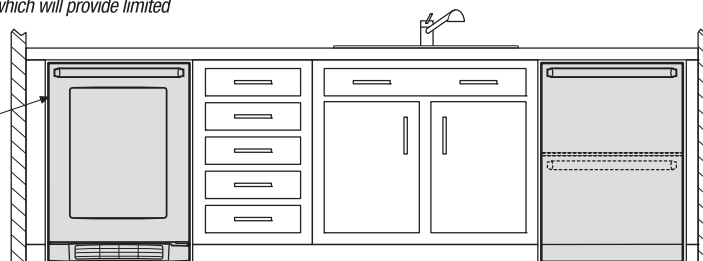

Top

When installing appliance with side-swing door adjacent to wall, cabinet, or other obstruction that extends beyond front edge of appliance, door swing and handle clearance must be sufficient to allow access to appliance interior.

When installing appliance with sliding drawer or drop-down door directly across from obstructions, provide sufficient clearance for drawer extension or door swing.

When installing appliance with sliding drawer or drop-down door adjacent to wall, cabinet, or other obstruction that extends beyond front edge of appliance, allow 2" minimum clearance between drawer or door and obstruction.

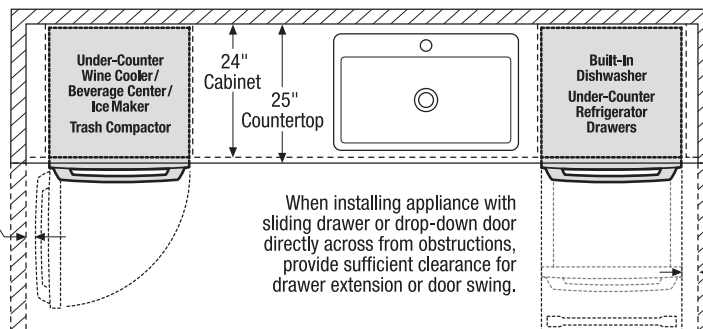

Electrolux Major Appliances, N.A.

USA • 10200 David Taylor Drive • Charlotte, NC 28262 • 1-877-4electrolux (1-877-435-3287) • electroluxappliances.com
 CANADA • 5855 Terry Fox Way • Mississauga, ON L5V 3E4 • 1-800-265-8352 • electroluxappliances.ca

General Installation Guidelines

For Installation with All Refrigerator or All Freezer



Use these dimensions and clearance instructions for planning purposes only. For detailed installation instructions, refer to installation guide, packed with product, or on the web at electroluxappliances.com.

Front

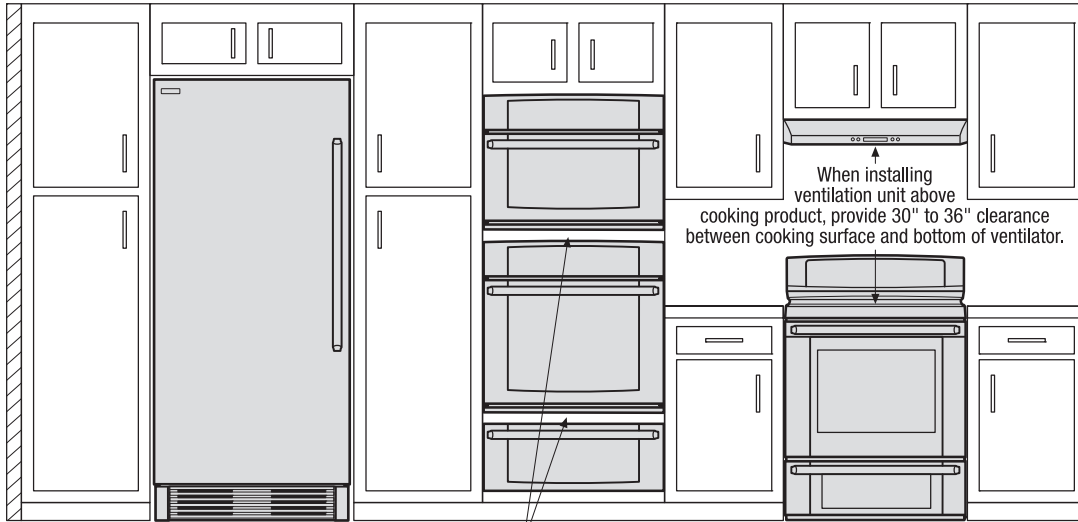

Top

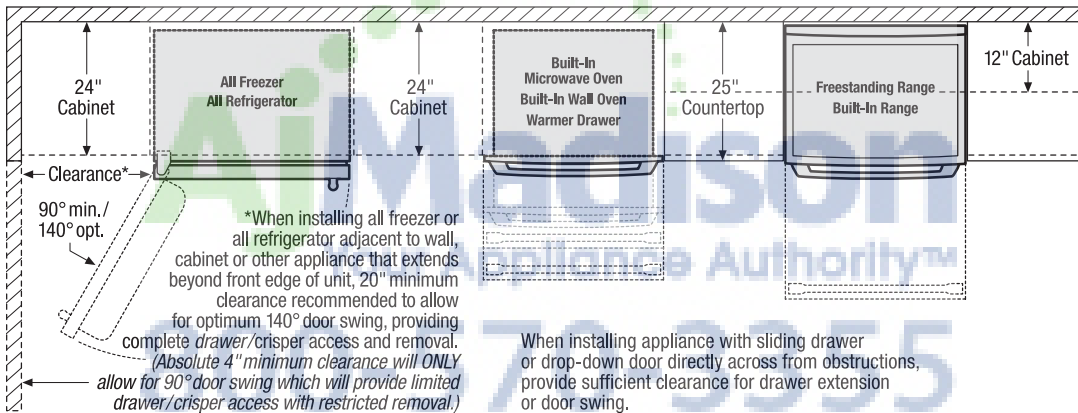

Front

To ensure optimum performance, avoid installing refrigeration appliances in direct sunlight or near heat source.

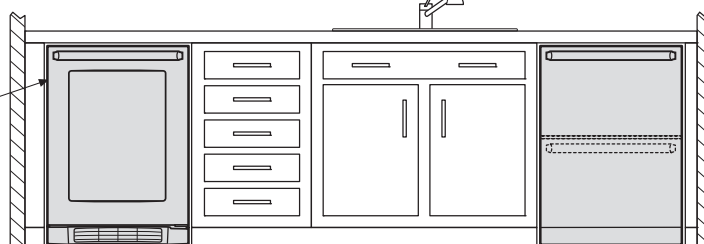

Top

When installing appliance with side-swing door adjacent to wall, cabinet, or other obstruction that extends beyond front edge of appliance, door swing and handle clearance must be sufficient to allow access to appliance interior.

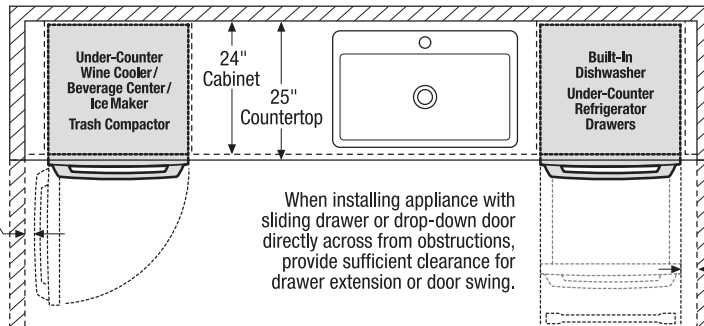

Electrolux Major Appliances, N.A.

USA • 10200 David Taylor Drive • Charlotte, NC 28262 • 1-877-4electrolux (1-877-435-3287) • electroluxappliances.com
 CANADA • 5855 Terry Fox Way • Mississauga, ON L5V 3E4 • 1-800-265-8352 • electroluxappliances.ca