



2021
COLLECTION

*Make
it
Wonderful*

FRANKE

Stainless Steel Sinks

Fireclay Sinks

Granite Sinks

Faucets

Filtration

Soap Dispensers

Waste Disposers

Accessories

Quick Reference

CONTACT US
Franke Kitchen Systems, LLC
800 Aviation Parkway, Smyrna, TN 37167
800-626-5771
ks-customerservice.us@franke.com
franke.us



Contents 2021

STAINLESS STEEL SERIES

- 10-15 Manor House
- 16-21 Culinary Center
- 22-27 Chef Center
- 28-35 Peak
- 36-45 Professional 2.0
- 46-51 Crystal
- 52-61 Pescara
- 62-65 Orca 2.0
- 66-69 Prestige
- 70-73 Regatta
- 74-85 Cube
- 86-93 Grande
- 94-97 Rotondo

OUTDOOR COLLECTION

- 98-103 Outdoor Series

FIRECLAY SERIES

- 108-113 Farm House
- 114-119 Manor House
- 120-123 Orca
- 124-127 Prestige
- 128-133 Cisterna

GRANITE SERIES

- 138-145 Peak
- 146-153 Urban
- 154-159 Maris
- 160-163 Kubus
- 164-171 Ellipse
- 172-175 Primo
- 176-179 Gravity
- 180-183 Quantum

FAUCET SERIES

- 190-195 Farm House
- 196-199 Professional
- 200-201 Crystal
- 202-207 Absinthe
- 208-215 Pescara
- 216-217 Peak
- 218-223 Ambient
- 224-229 Steel
- 230-233 Active
- 234-235 Kubus
- 236-239 Cube

FILTRATION

- 240-248 Filtration Faucets
- 249-253 Filtration System

SOAP DISPENSERS

WASTE DISPOSERS

ACCESSORIES

QUICK REFERENCE

- 274-279 Stainless Sinks & Accessories
- 280 Fireclay Sinks & Accessories
- 281-282 Granite Sinks & Accessories
- 283-285 Minimum Cabinet Size
- 286-289 Faucet Style Guide
- 290-293 Terms & Conditions
- 294-297 Category Index
- 298-301 Alphabetical Index

On the cover: PTX110-28 sink with FFPD4450 faucet

Part No. FCAT0121
Print 1/2021

© 2021 Franke Kitchen Systems, LLC
All rights reserved. Printed in USA.

Kitchen sinks that feel tailor-made.

From top-quality materials to exquisite craftsmanship, Franke sinks give you the quality you deserve. What makes our sinks even more wonderful is the fact that we work with you to make sure you select the perfect sink for your home. How often do you cook? How much space do you have? How many people live in your home? This is the sort of detail we go into to ensure you find a sink that you'll love.



Stainless Steel

Wonderfully effective

It's no accident that 65% of sinks in North America are made of stainless steel. It looks good in almost any kitchen. What's more, it's corrosion-resistant, has a virtually non-porous surface for easy cleaning and is extremely hygienic. Stainless steel also bonds with oxygen to form a passive protective layer that continuously renews itself. It can withstand extreme temperatures and, last but not least, it is rust-resistant.

Fireclay

Made by fire

The perfect blend of nature and design, fireclay is made of liquid ceramic which is then fired to create a material that feels incomparably smooth and is tremendously hard-wearing. Whether you prefer classic or modern design, you will simply love the delicate shapes of our Fireclay sinks.



Granite

Superbly hard-wearing

Sinks made of granite are particularly elegant and bring a natural look into your kitchen. Our processed granite has a soft matte finish and feels warm to the touch. The surface is finely textured and non-porous, ensuring a high standard of hygiene. Composed of 80% quartz sand and 20% very hard acrylic resin, Franke's hard-wearing granite gives you years of beauty.

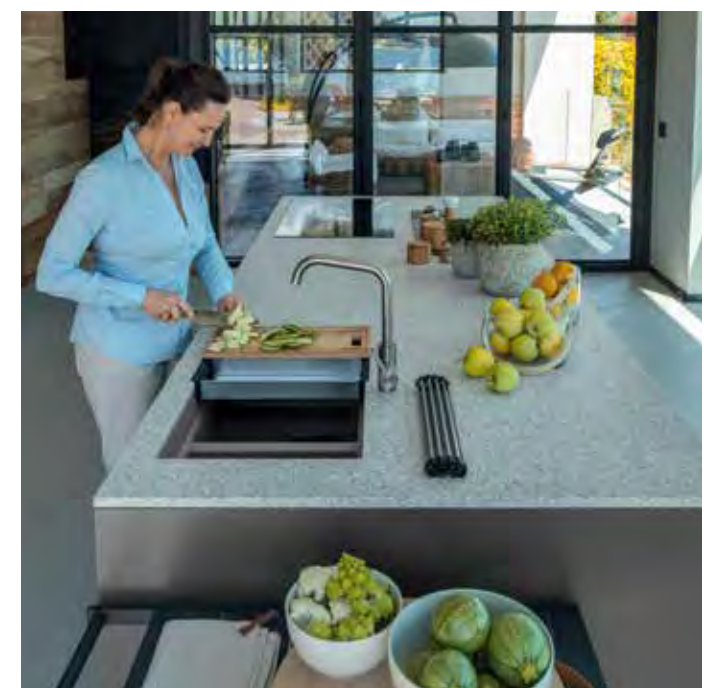



Stainless Steel Sinks

| | |
|------------------|-------|
| Manor House | 10-15 |
| Culinary Center | 16-21 |
| Chef Center | 22-27 |
| Peak | 28-35 |
| Professional 2.0 | 36-45 |
| Crystal | 46-51 |
| Pescara | 52-61 |
| Orca 2.0 | 62-65 |
| Prestige | 66-69 |
| Regatta | 70-73 |
| Cube | 74-85 |
| Grande | 86-93 |
| Rotondo | 94-97 |

OUTDOOR COLLECTION

| | |
|----------------|--------|
| Outdoor Series | 98-103 |
|----------------|--------|



Why Franke Stainless Steel?

Stainless steel is the material most frequently used for sinks, and the most popular countertop for commercial kitchens. As one of the world's largest buyers of stainless steel for kitchens, we have perfected its evolution over decades to bring you unique quality.

WHAT MAKES IT SO SPECIAL?

A classic material that can handle high temperature, is very hygienic and offers a timeless aesthetic.

Corrosion resistant: premium quality chrome nickel steel makes sinks highly resistant to staining, rust and corrosion

Non-porous: naturally hygienic

Self-regenerating: stainless steel surfaces develop a passive protective layer that continuously renews, so your sink is easy to clean and care for

Durable: highly temperature and acid resistant

Environmentally-friendly: 100% recyclable

CHOOSING THE IDEAL GAUGE

The standard gauge describes the thickness of a metal sheet, on a scale from 8 to 30. The lower the number, the thicker the metal sheet. The thicker it is, the less it can be bent or dented and the quieter it is in use. If too thin, it becomes impossible to produce a sink from a single sheet of metal. So we take great care when choosing the right standard gauge for our sinks:

- Most deep-drawn sinks in full size have a standard 18 gauge
- Hand-made sinks have a standard 16-19 gauge

STAINLESS STEEL FINISHES



DIAMOND FINISH

Our Diamond finish creates a shiny, almost flawless, appearance that highlights the sink's elegance and makes it an attractive centerpiece to your kitchen.



PEARL FINISH

Our exclusive Pearl finish camouflages everyday wear like a commercial sink while adding an element of modern luxury to your kitchen.



SILK FINISH

This elegant, easy-to-clean finish is beautifully shiny in appearance and scratch resistant.



Pictured: MHX710-33 sink with FF5280 faucet

Manor House

If you are looking to design a modern farmhouse kitchen, look no further than these Manor House sinks. Soft lines, modern features, rustic elements and a large, deep bowl add a refined sophistication to any kitchen while also warm and inviting.



Function is still important, but homeowners today are a lot more interested in design. Modern farmhouse style breathes new life into the old, putting a contemporary twist on country charm.

Manor House



classically
SIMPLE

1

Apron Front

The front of the sink extends out slightly from the cabinet bringing the work space closer, eliminating the need to lean over the counter.



2

Extra Deep Bowl

9" deep basin boosts flexibility of use, easily accommodating nearly any pot, pan, or large items that can't go into the dishwasher.



3

Commercial Grade Stainless

Made of 16 gauge stainless steel with a Pearl finish that will retain its beauty for many years.



4

Precision Drain

Sloped, elegant lines on the bottom of the bowl ensure an easy, clean drain every time.



MHX710-30 \$2,190



SPECIFICATIONS



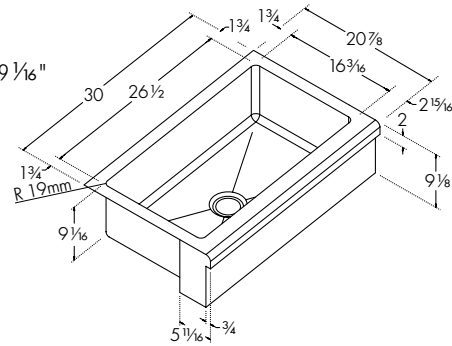



Interior Dimensions: 26 1/2" x 16 3/16" x 9 1/16"
 Exterior Dimensions: 30" x 20 7/8"
 Minimum Cabinet Size: 30"
 Gauge: 16
 Weight: 39 lbs.
 Sound Dampening: Sound Pad
 Stainless Finish: Pearl
 Corner Radius: 19mm
 Installation: Undermount Apron Front
 Sides and back are not finished.

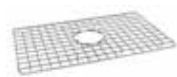

ACCESSORIES

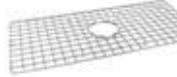
| | | | | |
|----------------------------------|----------------------------------|--|--|----------------------------|
| 1 Bottom Grid MH30-36S | 4 Cutting Board OA-40S | 5 Twist Waste Kit FRTWIST-SN | 6 Strainer Basket 906 906SN | 7 Inox Cream 903 |
|----------------------------------|----------------------------------|--|--|----------------------------|

ACCESSORIES

| | | | | |
|---|---|---|--|---|
|  1 Bottom Grid 26 1/8" x 15 13/16" Stainless MH30-36S \$230 |  2 Bottom Grid 29 1/8" x 15 13/16" Stainless MH33-36S \$255 |  3 Bottom Grid 32 1/8" x 15 13/16" Stainless MH36-36S \$280 |  4 Cutting Board 14 1/2" x 21 7/8" Solid Wood OA-40S \$385 |  5 Twist Waste Kit FRTWIST-SN \$170 |
|  6 Strainer Basket Chrome 906 \$70 Satin Nickel 906SN \$95 |  7 Inox Cream Stainless Steel Polish 903 \$35 | | | |

MHX710-33 \$2,630



SPECIFICATIONS

Interior Dimensions: 29 1/2" x 16 3/16" x 9 1/16"
 Exterior Dimensions: 33" x 20 7/8"
 Minimum Cabinet Size: 33"
 Gauge: 16
 Weight: 46 lbs.
 Sound Dampening: Sound Pad
 Stainless Finish: Pearl
 Corner Radius: 19mm
 Installation: Undermount Apron Front
 Sides and back are not finished.

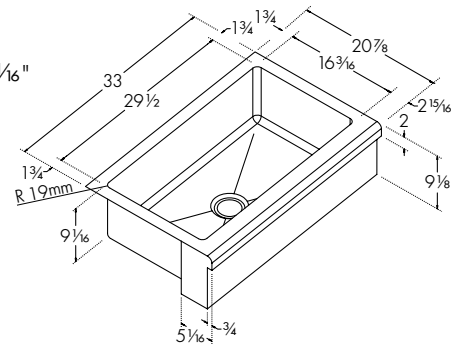

ACCESSORIES

| | | | | |
|----------------------------------|----------------------------------|--|--|----------------------------|
| 2 Bottom Grid MH33-36S | 4 Cutting Board OA-40S | 5 Twist Waste Kit FRTWIST-SN | 6 Strainer Basket 906 906SN | 7 Inox Cream 903 |
|----------------------------------|----------------------------------|--|--|----------------------------|

MHX710-36 \$3,175



SPECIFICATIONS

Interior Dimensions: 32 1/2" x 16 3/16" x 9 1/16"
 Exterior Dimensions: 36" x 20 7/8"
 Minimum Cabinet Size: 36"
 Gauge: 16
 Weight: 48 lbs.
 Sound Dampening: Sound Pad
 Stainless Finish: Pearl
 Corner Radius: 19mm
 Installation: Undermount Apron Front
 Sides and back are not finished.

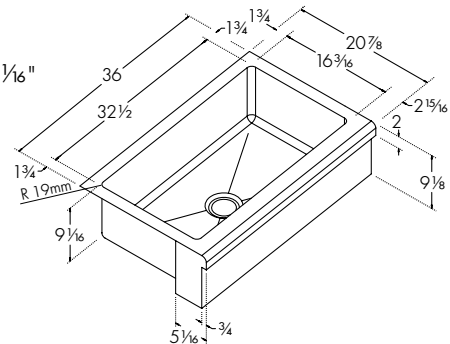

ACCESSORIES

| | | | | |
|----------------------------------|----------------------------------|--|--|----------------------------|
| 3 Bottom Grid MH36-36S | 4 Cutting Board OA-40S | 5 Twist Waste Kit FRTWIST-SN | 6 Strainer Basket 906 906SN | 7 Inox Cream 903 |
|----------------------------------|----------------------------------|--|--|----------------------------|

Note: All accessories sold separately unless otherwise indicated. Design of custom accessories subject to change without notice. It is absolutely critical that you have the sink and any custom sink accessories on site prior to any cut or modification to the countertop. Franke will not be responsible for any errors in countertop preparation and sink installation.

Culinary Center

Innovation meets **minimalist beauty** with the Culinary Center. Packed with **built-in features** that put everyday tools at your fingertips as you work, this **double-sink workstation** makes a magnificent transformation to a clean, modern statement in elegance.



The kitchen prep zone is crucial, since it is where we spend the majority of our time in the kitchen. It is the work center where meals are prepped and combined prior to being cooked.



Pictured: CUX16021-W sink with FF4800 faucet

Culinary Center

a focus on
FUNCTION

1

Complete Workstation

Complete kitchen solution with every accessory integrated and stored, bringing efficient workflow to the most basic necessity in the kitchen: the sink.



2

Essential Accessories

The epitome of efficiency, the most used accessories are neatly stored in the compartment bowl right where you need them for prepping food.



3

Double Bowl Sink

Storage compartment bowl doubles as an additional sink for cleaning or prepping.



4

Design Details

The minimalist beauty of the 12mm radius corners and round drain cover accentuate the elegance of the design.



Perfectly Organized



A place for everything

The double-sink Culinary Center features **essential accessories** built right into the sleek design. When tasks are complete, everything stores neatly into this **well-thought-out system**.



Designed for the way you work

The Culinary Center's two cutting boards, colander and draining rack are easily removed and positioned to fit the workflow that's most efficient for you. Rinsing, draining, chopping, dicing and slicing are a snap when **the right tools are at hand**.



Details matter

The Culinary Center features dual sinks, both with easy-to-reach corners. The custom-fitted accessories compartment allows you to dry and store the tools you use most so they're ready when you need them. At the end of the day you'll have a **neat and organized kitchen workstation** with everything in its place.

CUX11010-W \$1,860



Note:
Included accessories can be stored within the sink. They are meant to be used on the counter and are not a custom fit with this sink.

SPECIFICATIONS

Interior Dimensions: 10³/₁₆" x 18⁷/₈" x 8¹/₁₆"
Exterior Dimensions: 13¹/₈" x 21³/₈"
Minimum Cabinet Size: 18"
Gauge: 19
Weight: 19 lbs.
Sound Dampening: Sound Pad
Stainless Finish: Diamond
Corner Radius: 12mm
Installation: Undermount with 1/2" Reveal

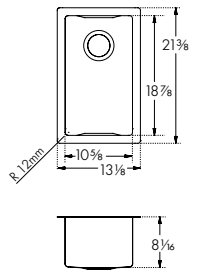

ACCESSORIES

| | | | | | | | | | | | | | | | | | | | |
|---|--|---|--|---|--|---|--|---|---|---|---------------------------------------|---|--|---|---------------------------------------|----|---|----|--|
| 2 | Cutting Board CU-40S Included | 3 | Cutting Board CU-40P Included | 4 | Cutting Mat SP-40S Included | 5 | Glass Cover/ Cutting Board CU-GC Included | 6 | Knife Holder + Cutting Board CU-40K Included | 7 | Knife Set CU-KS Included | 8 | Colander CUW-70S Included | 9 | Wire Rack CU-WR Included | 10 | Frame Cover CU-FC Included | 11 | Strainer Basket 906 906SN |
|---|--|---|--|---|--|---|--|---|---|---|---------------------------------------|---|--|---|---------------------------------------|----|---|----|--|

CUX16021-W \$2,520



SPECIFICATIONS



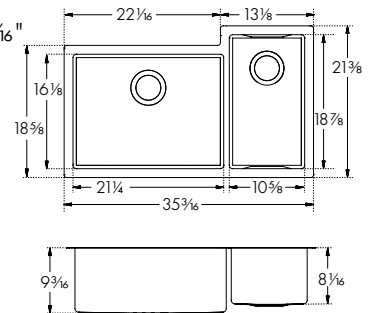









Interior Dimensions: 32¹/₁₆" x 18⁷/₈" x 9³/₁₆" & 8¹/₁₆"
Exterior Dimensions: 35³/₁₆" x 21³/₈"
Minimum Cabinet Size: 39"
Gauge: 19
Weight: 50 lbs.
Sound Dampening: Sound Pad
Stainless Finish: Diamond
Corner Radius: 12mm
Installation: Undermount with 1/2" Reveal



ACCESSORIES

| | | | | | | | | | | | | | | | | | | | | | |
|---|--|---|--|---|--|---|--|---|--|---|---|---|---------------------------------------|---|--|---|---------------------------------------|----|---|----|--|
| 1 | Bottom Grid CU21-36S Optional | 2 | Cutting Board CU-40S Included | 3 | Cutting Board CU-40P Included | 4 | Cutting Mat SP-40S Included | 5 | Glass Cover/ Cutting Board CU-GC Included | 6 | Knife Holder + Cutting Board CU-40K Included | 7 | Knife Set CU-KS Included | 8 | Colander CUW-70S Included | 9 | Wire Rack CU-WR Included | 10 | Frame Cover CU-FC Included | 11 | Strainer Basket 906 906SN |
|---|--|---|--|---|--|---|--|---|--|---|---|---|---------------------------------------|---|--|---|---------------------------------------|----|---|----|--|

ACCESSORIES

| | | | | | |
|---|---|---|--|---|--|
|  1 Bottom Grid 20 ³ / ₁₆ " x 15 ³ / ₁₆ " Stainless CU21-36S \$150 |  2 Cutting Board 7 ¹ / ₁₆ " x 16 ⁷ / ₈ " Walnut CU-40S \$160 Included |  3 Cutting Board 7 ¹ / ₁₆ " x 16 ⁷ / ₈ " Black Plastic CU-40P \$105 Included |  4 Cutting Mat 11 ¹ / ₄ " x 17 ³ / ₄ " Silicone SP-40S \$60 Included |  5 Glass Cover/ Cutting Board 11 ¹ / ₂ " x 19 ³ / ₄ " Black Glass CU-GC \$125 Included |  6 Knife Holder+ Cutting Board 7 ³ / ₁₆ " x 16 ⁷ / ₈ " Walnut CU-40K \$255 Included |
|  7 Knife Set Set of 3 Black CU-KS \$105 Included |  8 Colander 6 ³ / ₁₆ " x 17 ³ / ₈ " x 2 ¹ / ₈ " Stainless CUW-70S \$210 Included |  9 Wire Rack 11" x 18 ³ / ₄ " Stainless CU-WR \$135 Included |  10 Frame Cover 10 ¹ / ₂ " x 18 ¹³ / ₁₆ " Stainless Finish CU-FC \$215 Included |  11 Strainer Basket Chrome 906 \$70 Satin Nickel 906SN \$95 |  Drain Cover 4 ¹ / ₂ " Stainless RNDVCVR \$90 One included with CUX16021-W |

Note: All accessories sold separately unless otherwise indicated. Design of custom accessories subject to change without notice. It is absolutely critical that you have the sink and any custom sink accessories on site prior to any cut or modification to the countertop. Franke will not be responsible for any errors in countertop preparation and sink installation.



Pictured: CUX11024-W sink with FF4420 faucet



Chef Center

Franke's Chef Center gives you the power of a beautifully designed sink system. **Every accessory is included** and right at hand.

The Chef Center's **wide basin** accommodates large pots and pans easily. The **multi-level sink grid** and **roller mat** are practical accessories designed for any kitchen task, including drying dishes and stemware. A generously sized **drain board** features a sloped design that fits over the edge of the sink to direct water back into the sink.

Chef Center

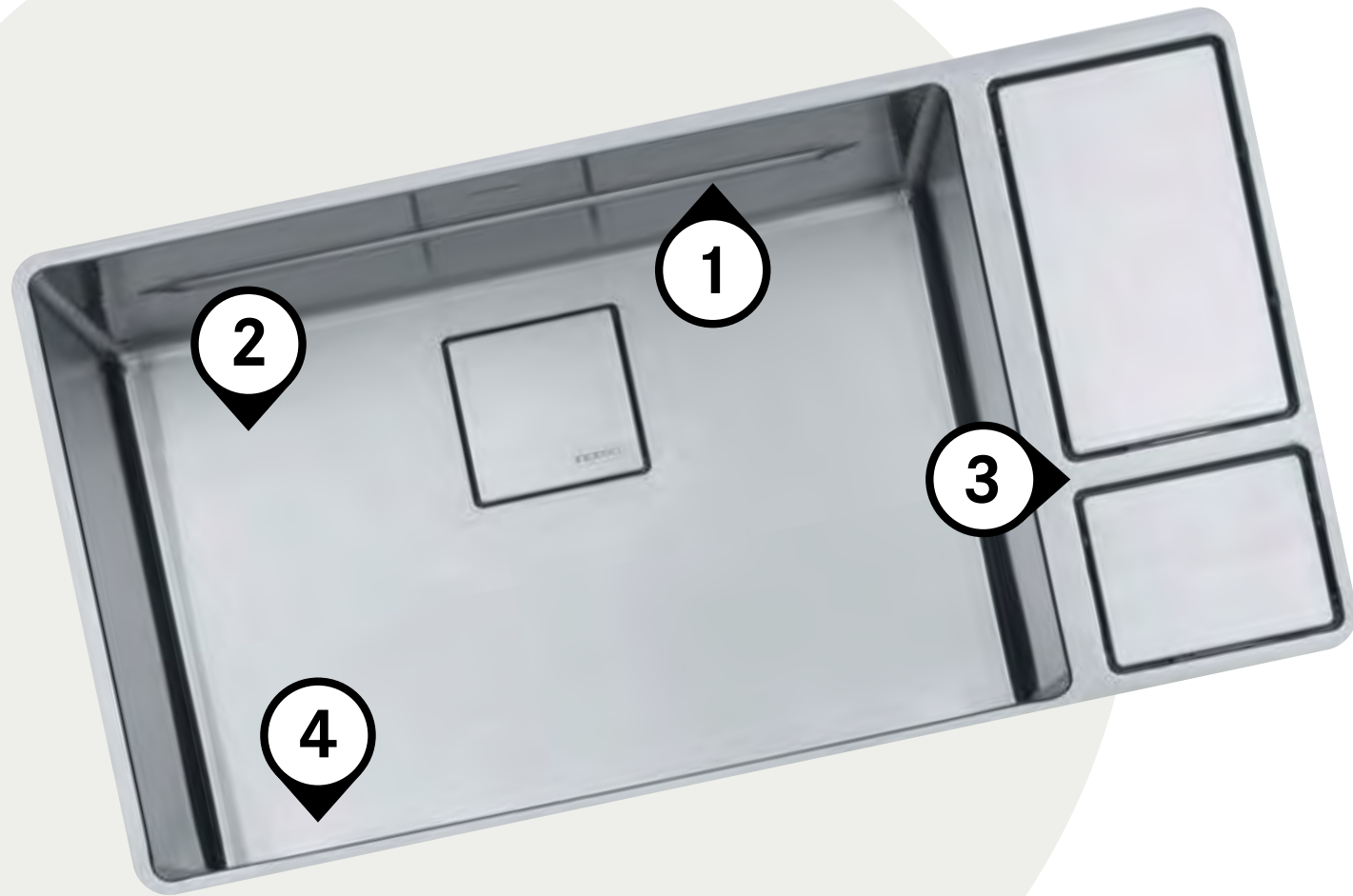

**no detail
OVERLOOKED**

1

Ledge System

The reveal and integrated ledge allow for a seamless workflow with the custom fit accessories.



2

All-in-One Workspace

Seamless workflow, unobstructed surfaces, and integrated accessories - a complete solution.



3

Storage & Composting Bins

Made from antimicrobial material to reduce odors. Convenient handle allows you to remove the rear compost bin and the front bin can be used to store prepping and cleaning tools.

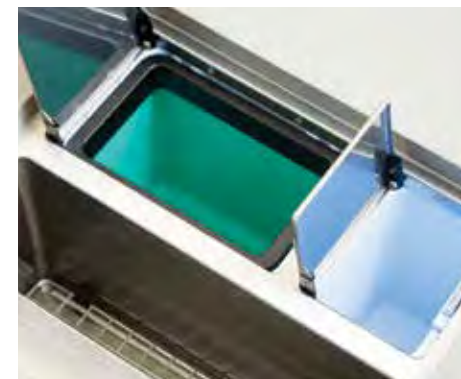

4

Deep Capacity Bowl

A large deep bowl makes it easy to clean large cookware items and minimizes splashing, offering the form and function you expect from your sink.



CUX11018-W \$2,635

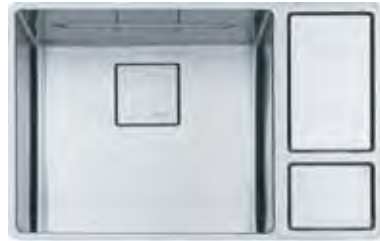

SPECIFICATIONS

Interior Dimensions: 18 1/8" x 16 1/8" x 9"
 Exterior Dimensions: 28 1/8" x 18 7/8"
 Minimum Cabinet Size: 33"
 Gauge: 18
 Weight: 55 lbs.
 Sound Dampening: Sound Pad & Spray Coat
 Stainless Finish: Diamond
 Integral Franke Ledge System
 Corner Radius: 12mm
 Installation: Undermount with 1/2" Reveal

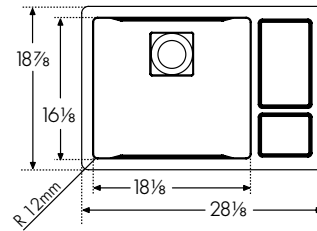

INCLUDED ACCESSORIES

- | | | | | | | |
|--|---|--|--|---|---|--|
| 1 Bottom/ Shelf Grid CUW18-36S Included | 4 Glass Cutting Board CUW-40S Included | 5 Cutting Mat SP-40S Included | 6 Colander CUW-70S Included | 7 Roller Mat CUW-36RM Included | 8 Drain Board CUW-60S Included | 9 Drain Cover PKGCVR Included |
|--|---|--|--|---|---|--|

INCLUDED ACCESSORIES

- | | | | | | |
|--|--|--|---|---|---|
| 1 Bottom/ Shelf Grid 17 13/16" x 15 7/8" Stainless CUW18-36S \$150 Included | 2 Bottom/ Shelf Grid 23 11/32" x 15 7/8" Stainless CUW24-36S \$165 Included | 3 Bottom/ Shelf Grid 31 1/2" x 16" Stainless CUW31-36S \$175 Included | 4 Glass Cutting Board 10 9/16" x 17 1/16" Glass CUW-40S \$175 Included | 5 Cutting Mat 9 13/16" x 14 7/8" Silicone SP-40S \$60 Included | 6 Colander 6 3/16" x 17 5/8" x 2 1/8" Stainless CUW-70S \$210 Included |
|--|--|--|---|---|---|

OPTIONAL ACCESSORIES

- | | | | | | |
|---|---|---|--|--|--|
| 7 Roller Mat 17" x 15 7/8" Stainless CUW-36RM \$150 Included | 8 Drain Board 13 1/2" x 18 3/8" Stainless CUW-60S \$200 Included | 9 Drain Cover 4 7/8" x 4 7/8" Stainless PKGCVR \$90 Included | Push Button Strainer Kit Chrome 906P-C \$135 Satin Nickel 906P-SN \$160 | Strainer Basket Chrome 906 \$70 Satin Nickel 906SN \$95 | Inox Cream Stainless Steel Polish 903 \$35 |
|---|---|---|--|--|--|

CUX11024-W \$2,850



SPECIFICATIONS

Interior Dimensions: 23 5/8" x 16 1/8" x 9"
 Exterior Dimensions: 33 5/8" x 18 7/8"
 Minimum Cabinet Size: 36"
 Gauge: 18
 Weight: 57 lbs.
 Sound Dampening: Sound Pad & Spray Coat
 Stainless Finish: Diamond
 Integral Franke Ledge System
 Corner Radius: 12mm
 Installation: Undermount with 1/2" Reveal

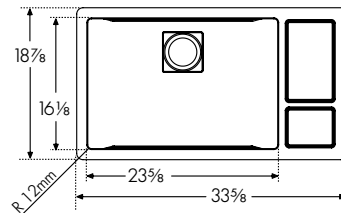

INCLUDED ACCESSORIES

- | | | | | | | |
|--|---|--|--|---|---|--|
| 2 Bottom/ Shelf Grid CUW24-36S Included | 4 Glass Cutting Board CUW-40S Included | 5 Cutting Mat SP-40S Included | 6 Colander CUW-70S Included | 7 Roller Mat CUW-36RM Included | 8 Drain Board CUW-60S Included | 9 Drain Cover PKGCVR Included |
|--|---|--|--|---|---|--|

CUX11031-W \$3,070



SPECIFICATIONS

Interior Dimensions: 31 5/8" x 16 1/8" x 9"
 Exterior Dimensions: 41 5/8" x 18 7/8"
 Minimum Cabinet Size: 45"
 Gauge: 18
 Weight: 60 lbs.
 Sound Dampening: Sound Pad & Spray Coat
 Stainless Finish: Diamond
 Integral Franke Ledge System
 Corner Radius: 12mm
 Installation: Undermount with 1/2" Reveal

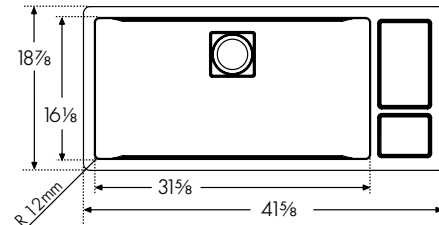

INCLUDED ACCESSORIES

- | | | | | | | |
|--|---|--|--|---|---|--|
| 3 Bottom/ Shelf Grid CUW31-36S Included | 4 Glass Cutting Board CUW-40S Included | 5 Cutting Mat SP-40S Included | 6 Colander CUW-70S Included | 7 Roller Mat CUW-36RM Included | 8 Drain Board CUW-60S Included | 9 Drain Cover PKGCVR Included |
|--|---|--|--|---|---|--|

Note: All accessories sold separately unless otherwise indicated. Design of custom accessories subject to change without notice. It is absolutely critical that you have the sink and any custom sink accessories on site prior to any cut or modification to the countertop. Franke will not be responsible for any errors in countertop preparation and sink installation.

Peak

Elegantly simple and exceedingly functional, the Peak Collection exudes luxury. **Clean lines** and the **5mm corner radius** maximize workspace. The **square drain cover** complements the minimalist design while obscuring the strainer and waste disposer.

Accessories such as shelf grids, colanders and cutting boards fit perfectly with the sink's **integrated ledge** or over the sink to expand functionality to fit any chef's food preparation style.



Pictured: PKX11028 sink with FFPD5550 faucet

Peak

1

Multi-Level Workspace

The bottom sink grid raises to sit on the integrated ledge, creating a higher level workspace to expand your prep, clean and rinse area.



2

Commercial Grade Stainless

Made of 16 gauge stainless steel with a Diamond finish that will retain its beauty for many years.



3

Rear Drain & Drain Cover

The removable drain cover conceals the drain for a seamless bowl surface, while providing a flat bottom surface to allow for more usable workspace.



4

Minimalist Design

5mm radius corners and invisible drain provide an eye-catching design element to the kitchen.



luxury at its PEAK

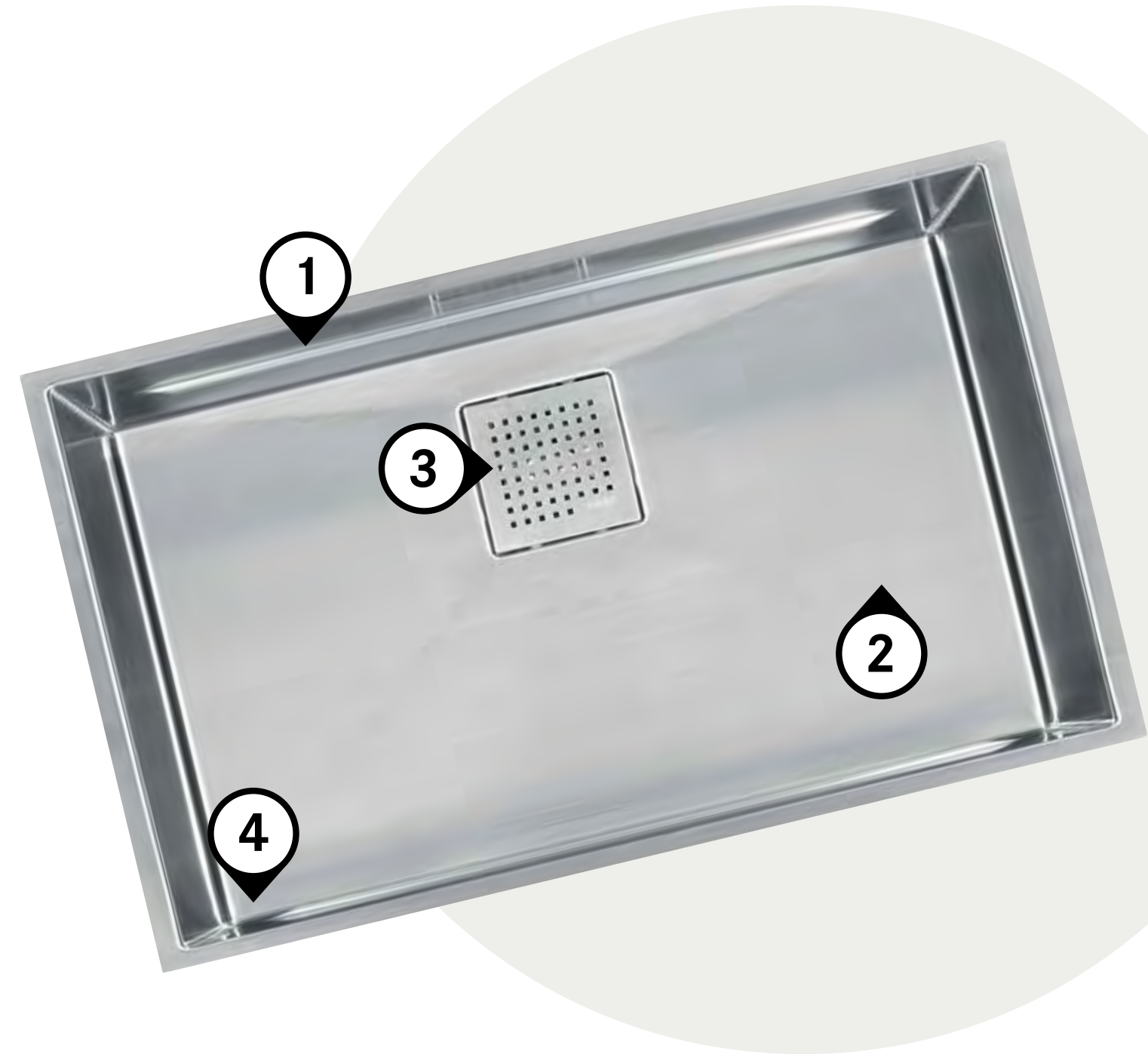

PKX1108 \$1,285



SPECIFICATIONS

Interior Dimensions: 7¹/₈" x 16¹/₂" x 7¹/₈"
 Exterior Dimensions: 8¹/₄" x 17³/₄"
 Minimum Cabinet Size: 12"
 Gauge: 18
 Weight: 9 lbs.
 Sound Dampening: Sound Pad & Spray Coat
 Stainless Finish: Diamond
 Corner Radius: 5mm
 Installation: Undermount

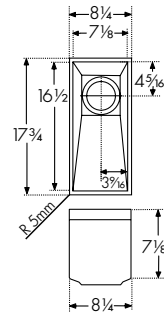

ACCESSORIES

- 5 **Colander** PX-70S
- 6 **Drain Cover** PKXCVR Included
- 8 **Universal Roller Mat** UV-36RM
- 9 **Twist Waste Kit** FRTWIST-SN
- 10 **Inox Cream** 903

PKX11013 \$2,055



SPECIFICATIONS

Interior Dimensions: 13³/₈" x 16¹/₂" x 9⁵/₈"
 Exterior Dimensions: 14¹/₂" x 17³/₄"
 Minimum Cabinet Size: 18"
 Gauge: 16
 Weight: 19 lbs.
 Sound Dampening: Sound Pad & Spray Coat
 Stainless Finish: Diamond
 Integral Franke Ledge System
 Corner Radius: 5mm
 Installation: Undermount

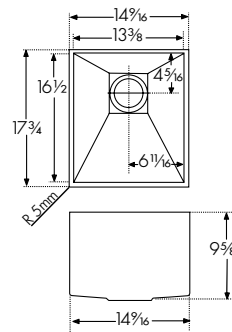

ACCESSORIES

- 1 **Bottom/Shelf Grid** PX-13S
- 5 **Colander** PX-70S
- 6 **Drain Cover** PKXCVR Included
- 8 **Universal Roller Mat** UV-36RM
- 9 **Twist Waste Kit** FRTWIST-SN
- 10 **Inox Cream** 903

PKX11016 \$2,275



SPECIFICATIONS

Interior Dimensions: 15³/₄" x 16¹/₂" x 9⁵/₈"
 Exterior Dimensions: 16⁷/₈" x 17³/₄"
 Minimum Cabinet Size: 21"
 Gauge: 16
 Weight: 21 lbs.
 Sound Dampening: Sound Pad & Spray Coat
 Stainless Finish: Diamond
 Integral Franke Ledge System
 Corner Radius: 5mm
 Installation: Undermount

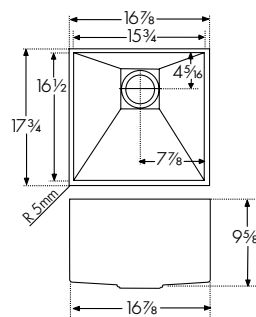

ACCESSORIES

- 2 **Bottom/Shelf Grid** PX-16S
- 5 **Colander** PX-70S
- 6 **Drain Cover** PKXCVR Included
- 7 **Cutting Board** PX-40S
- 8 **Universal Roller Mat** UV-36RM
- 9 **Twist Waste Kit** FRTWIST-SN
- 10 **Inox Cream** 903

PKX11018 \$2,445



SPECIFICATIONS

Interior Dimensions: 17³/₄" x 16¹/₂" x 9⁵/₈"
 Exterior Dimensions: 18⁷/₈" x 17³/₄"
 Minimum Cabinet Size: 24"
 Gauge: 16
 Weight: 22 lbs.
 Sound Dampening: Sound Pad & Spray Coat
 Stainless Finish: Diamond
 Integral Franke Ledge System
 Corner Radius: 5mm
 Installation: Undermount

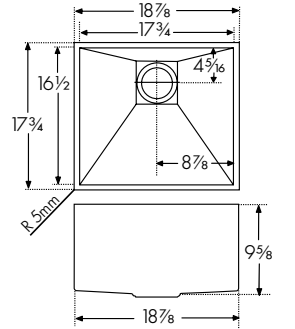

ACCESSORIES

- 3 **Bottom/Shelf Grid** PX-18S
- 5 **Colander** PX-70S
- 6 **Drain Cover** PKXCVR Included
- 7 **Cutting Board** PX-40S
- 8 **Universal Roller Mat** UV-36RM
- 9 **Twist Waste Kit** FRTWIST-SN
- 10 **Inox Cream** 903

PKX11021 \$2,605



SPECIFICATIONS

Interior Dimensions: 21⁵/₈" x 16¹/₂" x 9⁵/₈"
 Exterior Dimensions: 22¹/₂" x 17³/₄"
 Minimum Cabinet Size: 27"
 Gauge: 16
 Weight: 25 lbs.
 Sound Dampening: Sound Pad & Spray Coat
 Stainless Finish: Diamond
 Integral Franke Ledge System
 Corner Radius: 5mm
 Installation: Undermount

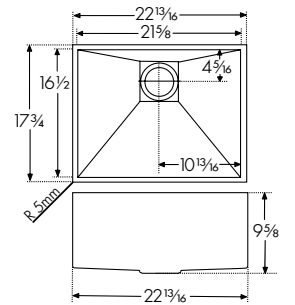

ACCESSORIES

- 4 **Bottom/Shelf Grid** PX-21S
- 5 **Colander** PX-70S
- 6 **Drain Cover** PKXCVR Included
- 7 **Cutting Board** PX-40S
- 8 **Universal Roller Mat** UV-36RM
- 9 **Twist Waste Kit** FRTWIST-SN
- 10 **Inox Cream** 903

ACCESSORIES

- 1 **Bottom/Shelf Grid** 13¹/₈" x 16¹/₄" Stainless PX-13S **\$150**
- 2 **Bottom/Shelf Grid** 15¹/₂" x 16¹/₄" Stainless PX-16S **\$150**
- 3 **Bottom/Shelf Grid** 17¹/₂" x 16¹/₄" Stainless PX-18S **\$165**
- 4 **Bottom/Shelf Grid** 21³/₈" x 16¹/₄" Stainless PX-21S **\$200**
- 5 **Colander** 6¹/₈" x 17³/₈" x 2¹/₈" Stainless PX-70S **\$220**
- 6 **Drain Cover** 4⁷/₈" x 4⁷/₈" Stainless PKXCVR **\$105**
One included with each sink
- 7 **Cutting Board** 14³/₈" x 17¹/₈" Solid Wood PX-40S **\$230**
- 8 **Universal Roller Mat** 18⁷/₈" x 20" Stainless UV-36RM **\$175**
- 9 **Twist Waste Kit** FRTWIST-SN **\$170**
- 10 **Inox Cream** Stainless Steel Polish 903 **\$35**

PKX11025 \$2,665



SPECIFICATIONS

Interior Dimensions: 25" x 16 1/2" x 9 5/8"
 Exterior Dimensions: 26 3/16" x 17 3/4"
 Minimum Cabinet Size: 30"
 Gauge: 16
 Weight: 27 lbs.
 Sound Dampening: Sound Pad & Spray Coat
 Integral Franke Ledge System
 Stainless Finish: Diamond
 Corner Radius: 5mm
 Installation: Undermount

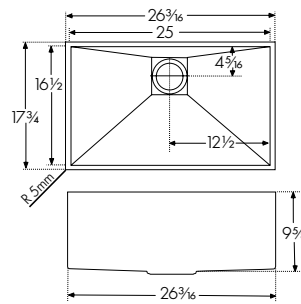

ACCESSORIES

- 2 **Bottom/ Shelf Grid** PX-25S
- 4 **Colander** PX-70S
- 5 **Drain Cover** PKXCVR Included
- 6 **Cutting Board** PX-40S
- 7 **Universal Roller Mat** UV-36RM
- 8 **Twist Waste Kit** FRTWIST-SN
- 9 **Inox Cream** 903

PKX11028 \$2,775



SPECIFICATIONS

Interior Dimensions: 27 9/16" x 16 1/2" x 9 5/8"
 Exterior Dimensions: 28 3/4" x 17 3/4"
 Minimum Cabinet Size: 33"
 Gauge: 16
 Weight: 29 lbs.
 Sound Dampening: Sound Pad & Spray Coat
 Integral Franke Ledge System
 Stainless Finish: Diamond
 Corner Radius: 5mm
 Installation: Undermount

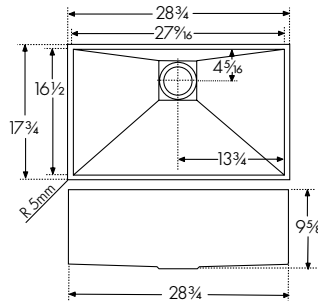

ACCESSORIES

- 3 **Bottom/ Shelf Grid** PX-28S
- 4 **Colander** PX-70S
- 5 **Drain Cover** PKXCVR Included
- 6 **Cutting Board** PX-40S
- 7 **Universal Roller Mat** UV-36RM
- 8 **Twist Waste Kit** FRTWIST-SN
- 9 **Inox Cream** 903

PKX160 \$3,150
PKX160LH \$3,150



(PKX160 Shown)

SPECIFICATIONS

Interior Dimensions: 29 3/4" x 16 1/2" x 9 5/8" & 7 1/8"
 Exterior Dimensions: 30 7/8" x 17 3/4"
 Minimum Cabinet Size: 36"
 Gauge: 16
 Weight: 35 lbs.
 Sound Dampening: Sound Pad & Spray Coat
 Stainless Finish: Diamond
 Integral Franke Ledge System: Large Bowl
 Corner Radius: 5mm
 Installation: Undermount

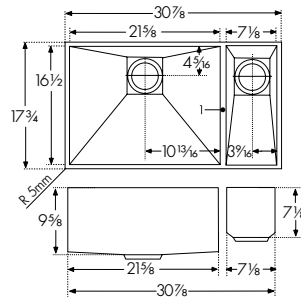

ACCESSORIES

- 1 **Bottom/ Shelf Grid** PX-21S
- 4 **Colander** PX-70S
- 5 **Drain Cover** PKXCVR (2) Included
- 6 **Cutting Board** PX-40S
- 7 **Universal Roller Mat** UV-36RM
- 8 **Twist Waste Kit** FRTWIST-SN
- 9 **Inox Cream** 903

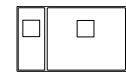

Left Hand Sink
 PKX160LH

ACCESSORIES

- 1 **Bottom/ Shelf Grid** 21 3/8" x 16 1/4" Stainless PX-21S \$200
- 2 **Bottom/ Shelf Grid** 24 3/4" x 16 1/4" Stainless PX-25S \$210
- 3 **Bottom/ Shelf Grid** 27 9/16" x 16 1/4" Stainless PX-28S \$220
- 4 **Colander** 6 1/8" x 17 9/16" x 2 1/8" Stainless PX-70S \$220
- 5 **Drain Cover** 4 7/8" x 4 7/8" Stainless PKXCVR \$105
 One included with each sink. PKX160 & PKX160LH include two.

- 6 **Cutting Board** 14 3/8" x 17 1/8" Solid Wood PX-40S \$230
- 7 **Universal Roller Mat** 18 7/16" x 20" Stainless UV-36RM \$175
- 8 **Twist Waste Kit** FRTWIST-SN \$170
- 9 **Inox Cream** Stainless Steel Polish 903 \$35

PERFECT TOGETHER

Peak Faucet

For the complete PEAK Faucet Collection see page 217



FFPD5550



Pictured: PS2X120-14-14 sink with FFPD5300 faucet

Professional 2.0

The second generation of this hard-working sink features a **Diamond stainless finish** that offers enduring beauty for years. Made of **16 gauge**, commercial-grade stainless steel and available in **a variety of size and configuration options**. It's the perfect partner for the serious home chef.



Professional 2.0

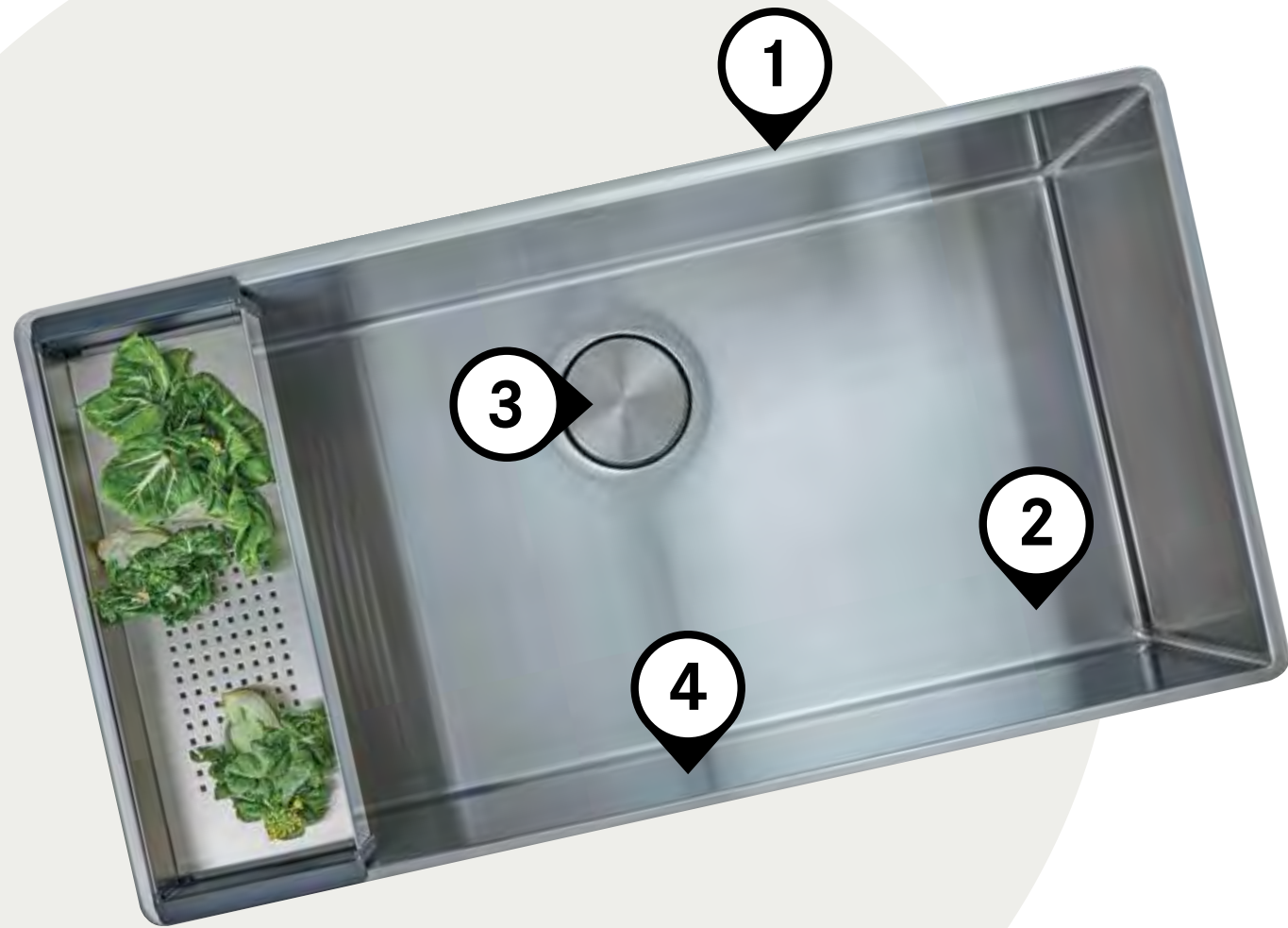

endless
STYLE

1

Integrated Reveal Ledge

Allows accessories to work within the sink creating a seamless workflow while prepping meals.



2

Diamond Finish

Durable finish takes minimal care to maintain a clean, attractive look for years.



3

Rear Drain Cover

The removable drain cover conceals the drain for a seamless bowl surface, while the rear placement provides extra cabinet space beneath the sink.



4

Deep Capacity Bowl

A large deep bowl makes it easy to clean large cookware items and minimizes splashing, offering the form and function you expect from your sink.



PS2X110-15 \$1,535



SPECIFICATIONS

Interior Dimensions: 15" x 17" x 8"
 Exterior Dimensions: 17½" x 19½"
 Minimum Cabinet Size: 21"
 Gauge: 16
 Weight: 21 lbs.
 Sound Dampening: Sound Pad and Spray Coat
 Stainless Finish: Diamond
 Corner Radius: 8mm
 Installation: Undermount with ½" Reveal

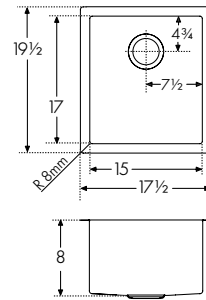

ACCESSORIES

- | | | | | | |
|-----------------------------|----------------------------|----------------------|-------------------------------------|-----------------------|-----------------------------------|
| 1 Bottom Grid PS2-15-36S | 5 Cutting Board PS2-45S | 6 Colander PE-70S | 7 Drain Cover RNDCVR Included | 8 Roller Mat RM18S | 9 Strainer Basket 906 906SN |
|-----------------------------|----------------------------|----------------------|-------------------------------------|-----------------------|-----------------------------------|

PS2X110-18 \$1,585



SPECIFICATIONS

Interior Dimensions: 18" x 17" x 10"
 Exterior Dimensions: 20½" x 19½"
 Minimum Cabinet Size: 24"
 Gauge: 16
 Weight: 23 lbs.
 Sound Dampening: Sound Pad and Spray Coat
 Stainless Finish: Diamond
 Corner Radius: 8mm
 Installation: Undermount with ½" Reveal

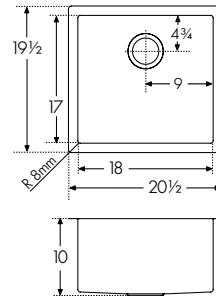

ACCESSORIES

- | | | | | | |
|-----------------------------|----------------------------|----------------------|-------------------------------------|-----------------------|-----------------------------------|
| 2 Bottom Grid PS2-18-36S | 5 Cutting Board PS2-45S | 6 Colander PE-70S | 7 Drain Cover RNDCVR Included | 8 Roller Mat RM18S | 9 Strainer Basket 906 906SN |
|-----------------------------|----------------------------|----------------------|-------------------------------------|-----------------------|-----------------------------------|

PS2X110-21 \$1,645



SPECIFICATIONS

Interior Dimensions: 21" x 17" x 10"
 Exterior Dimensions: 23½" x 19½"
 Minimum Cabinet Size: 27"
 Gauge: 16
 Weight: 25 lbs.
 Sound Dampening: Sound Pad and Spray Coat
 Stainless Finish: Diamond
 Corner Radius: 8mm
 Installation: Undermount with ½" Reveal

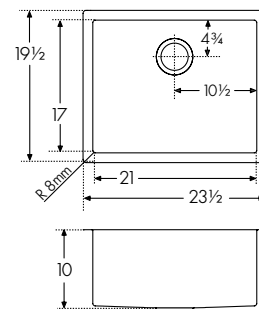

ACCESSORIES

- | | | | | | |
|-----------------------------|----------------------------|----------------------|-------------------------------------|-----------------------|-----------------------------------|
| 3 Bottom Grid PS2-21-36S | 5 Cutting Board PS2-45S | 6 Colander PE-70S | 7 Drain Cover RNDCVR Included | 8 Roller Mat RM18S | 9 Strainer Basket 906 906SN |
|-----------------------------|----------------------------|----------------------|-------------------------------------|-----------------------|-----------------------------------|

PS2X110-24 \$1,705



SPECIFICATIONS

Interior Dimensions: 24" x 17" x 10"
 Exterior Dimensions: 26½" x 19½"
 Minimum Cabinet Size: 30"
 Gauge: 16
 Weight: 27 lbs.
 Sound Dampening: Sound Pad and Spray Coat
 Stainless Finish: Diamond
 Corner Radius: 8mm
 Installation: Undermount with ½" Reveal

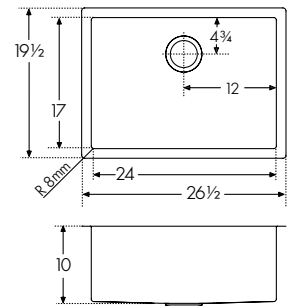

ACCESSORIES

- | | | | | | |
|-----------------------------|----------------------------|----------------------|-------------------------------------|-----------------------|-----------------------------------|
| 4 Bottom Grid PS2-24-36S | 5 Cutting Board PS2-45S | 6 Colander PE-70S | 7 Drain Cover RNDCVR Included | 8 Roller Mat RM18S | 9 Strainer Basket 906 906SN |
|-----------------------------|----------------------------|----------------------|-------------------------------------|-----------------------|-----------------------------------|

PS2X110-24-12 \$1,755



SPECIFICATIONS

Interior Dimensions: 24" x 17" x 12"
 Exterior Dimensions: 26½" x 19½"
 Minimum Cabinet Size: 30"
 Gauge: 16
 Weight: 29 lbs.
 Sound Dampening: Sound Pad and Spray Coat
 Stainless Finish: Diamond
 Corner Radius: 8mm
 Installation: Undermount with ½" Reveal

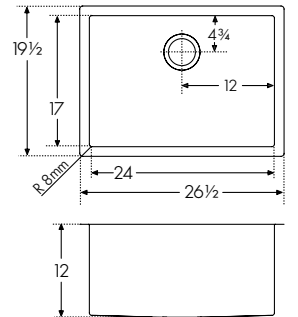

ACCESSORIES

- | | | | | | |
|-----------------------------|----------------------------|----------------------|-------------------------------------|-----------------------|-----------------------------------|
| 4 Bottom Grid PS2-24-36S | 5 Cutting Board PS2-45S | 6 Colander PE-70S | 7 Drain Cover RNDCVR Included | 8 Roller Mat RM18S | 9 Strainer Basket 906 906SN |
|-----------------------------|----------------------------|----------------------|-------------------------------------|-----------------------|-----------------------------------|

ACCESSORIES

- | | | | | |
|--|---|--|---|---|
| 1 Bottom Grid 14½" x 16½" Stainless PS2-15-36S \$150 | 2 Bottom Grid 17½" x 16½" Stainless PS2-18-36S \$165 | 3 Bottom Grid 20½" x 16½" Stainless PS2-21-36S \$200 | 4 Bottom Grid 23½" x 16½" Stainless PS2-24-36S \$210 | 5 Cutting Board 11" x 17⅞" x 1" Maple PS2-45S \$230 |
| 6 Colander 6⅞" x 17⅞" x 2⅞" Stainless PE-70S \$230 | 7 Drain Cover 4½" Stainless RNDCVR \$90 One included with each sink. | 8 Roller Mat 12⅜" x 17⅞" Stainless RM18S \$165 | 9 Strainer Basket Chrome 906 \$70 Satin Nickel 906SN \$95 | |

PS2X110-27 \$1,815



SPECIFICATIONS

Interior Dimensions: 27" x 17" x 10"
 Exterior Dimensions: 29½" x 19½"
 Minimum Cabinet Size: 33"
 Gauge: 16
 Weight: 29 lbs.
 Sound Dampening: Sound Pad and Spray Coat
 Stainless Finish: Diamond
 Corner Radius: 8mm
 Installation: Undermount with ½" Reveal

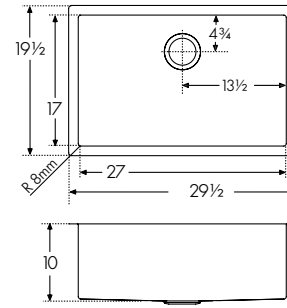

ACCESSORIES

- | | | | | | |
|--------------------------------------|-------------------------------------|-------------------------------|--|--------------------------------|---|
| 3 Bottom Grid PS2-27-36S | 6 Cutting Board PS2-45S | 7 Colander PE-70S | 8 Drain Cover RNDCVR Included | 9 Roller Mat RM18S | 10 Strainer Basket 906 906SN |
|--------------------------------------|-------------------------------------|-------------------------------|--|--------------------------------|---|

PS2X110-33 \$2,190



SPECIFICATIONS

Interior Dimensions: 33" x 17" x 10"
 Exterior Dimensions: 35½" x 19½"
 Minimum Cabinet Size: 39"
 Gauge: 16
 Weight: 33 lbs.
 Sound Dampening: Sound Pad and Spray Coat
 Stainless Finish: Diamond
 Corner Radius: 8mm
 Installation: Undermount with ½" Reveal

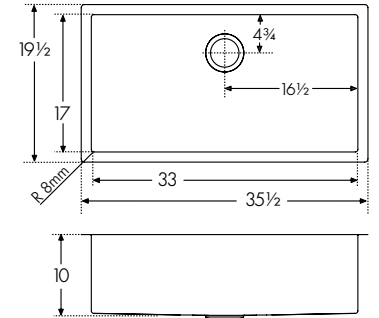

ACCESSORIES

- | | | | | | |
|--------------------------------------|-------------------------------------|-------------------------------|--|--------------------------------|---|
| 5 Bottom Grid PS2-33-36S | 6 Cutting Board PS2-45S | 7 Colander PE-70S | 8 Drain Cover RNDCVR Included | 9 Roller Mat RM18S | 10 Strainer Basket 906 906SN |
|--------------------------------------|-------------------------------------|-------------------------------|--|--------------------------------|---|

PS2X110-30 \$1,925



SPECIFICATIONS

Interior Dimensions: 30" x 17" x 10"
 Exterior Dimensions: 32½" x 19½"
 Minimum Cabinet Size: 36"
 Gauge: 16
 Weight: 31 lbs.
 Sound Dampening: Sound Pad and Spray Coat
 Stainless Finish: Diamond
 Corner Radius: 8mm
 Installation: Undermount with ½" Reveal

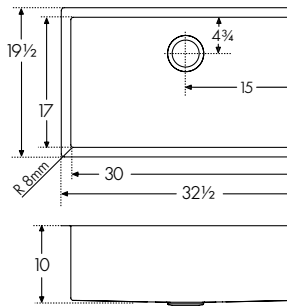

ACCESSORIES

- | | | | | | |
|--------------------------------------|-------------------------------------|-------------------------------|--|--------------------------------|---|
| 4 Bottom Grid PS2-30-36S | 6 Cutting Board PS2-45S | 7 Colander PE-70S | 8 Drain Cover RNDCVR Included | 9 Roller Mat RM18S | 10 Strainer Basket 906 906SN |
|--------------------------------------|-------------------------------------|-------------------------------|--|--------------------------------|---|

PS2X160-18-11 \$2,300



SPECIFICATIONS

Interior Dimensions: 30" x 17" x 10" & 9"
 Exterior Dimensions: 32½" x 19½"
 Minimum Cabinet Size: 36"
 Gauge: 16
 Weight: 34 lbs.
 Sound Dampening: Sound Pad and Spray Coat
 Stainless Finish: Diamond
 Corner Radius: 8mm
 Installation: Undermount with ½" Reveal

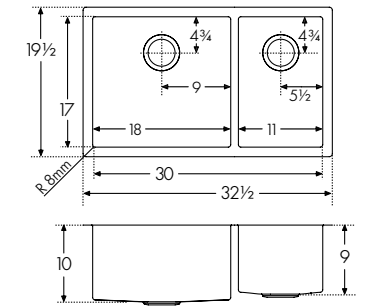

ACCESSORIES

- | | | | | | | |
|--------------------------------------|--------------------------------------|-------------------------------------|-------------------------------|--|--------------------------------|---|
| 1 Bottom Grid PS2-11-36S | 2 Bottom Grid PS2-18-36S | 6 Cutting Board PS2-45S | 7 Colander PE-70S | 8 Drain Cover RNDCVR (2) Included | 9 Roller Mat RM18S | 10 Strainer Basket 906 906SN |
|--------------------------------------|--------------------------------------|-------------------------------------|-------------------------------|--|--------------------------------|---|

PS2X110-30-12 \$2,035

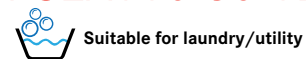

SPECIFICATIONS

Interior Dimensions: 30" x 17" x 12"
 Exterior Dimensions: 32½" x 19½"
 Minimum Cabinet Size: 36"
 Gauge: 16
 Weight: 32 lbs.
 Sound Dampening: Sound Pad and Spray Coat
 Stainless Finish: Diamond
 Corner Radius: 8mm
 Installation: Undermount with ½" Reveal

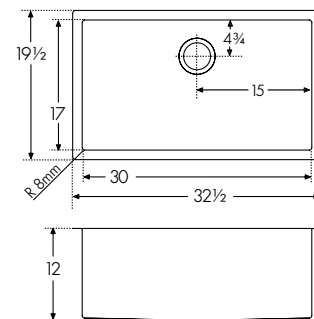

ACCESSORIES

- | | | | | | |
|--------------------------------------|-------------------------------------|-------------------------------|--|--------------------------------|---|
| 4 Bottom Grid PS2-30-36S | 6 Cutting Board PS2-45S | 7 Colander PE-70S | 8 Drain Cover RNDCVR Included | 9 Roller Mat RM18S | 10 Strainer Basket 906 906SN |
|--------------------------------------|-------------------------------------|-------------------------------|--|--------------------------------|---|

ACCESSORIES

- | | | | | |
|--|--|---|--|--|
|  1 Bottom Grid 10½" x 16½" Stainless PS2-11-36S \$130 |  2 Bottom Grid 17½" x 16½" Stainless PS2-18-36S \$165 |  3 Bottom Grid 26½" x 16½" Stainless PS2-27-36S \$230 |  4 Bottom Grid 29½" x 16½" Stainless PS2-30-36S \$270 |  5 Bottom Grid 32½" x 16½" Stainless PS2-33-36S \$290 |
|  6 Cutting Board 11" x 17⅞" x 1" Maple PS2-45S \$230 |  7 Colander 6⅞" x 17⅞" x 2⅞" Stainless PE-70S \$230 |  8 Drain Cover 4½" Stainless RNDCVR \$90 One included with each sink. PS2X160-18-11 includes two. |  9 Roller Mat 12 13⁄16" x 17⅞" Stainless RM18S \$165 |  10 Strainer Basket Chrome 906 \$70 Satin Nickel 906SN \$95 |

PS2X120-14-14 \$2,300



SPECIFICATIONS

Interior Dimensions: 29" x 17" x 10"
 Exterior Dimensions: 31 1/2" x 19 1/2"
 Minimum Cabinet Size: 36"
 Gauge: 16
 Weight: 32 lbs.
 Sound Dampening: Sound Pad and Spray Coat
 Stainless Finish: Diamond
 Corner Radius: 8mm
 Installation: Undermount with 1/2" Reveal

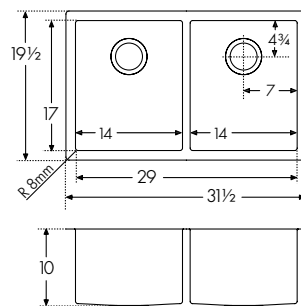

ACCESSORIES

- | | | | | | |
|--------------------------------------|-------------------------------------|-------------------------------|--|--------------------------------|--|
| 1 Bottom Grid PS2-14-36S | 3 Cutting Board PS2-45S | 4 Colander PE-70S | 5 Drain Cover RNDCVR (2) Included | 6 Roller Mat RM18S | 7 Strainer Basket 906 906SN |
|--------------------------------------|-------------------------------------|-------------------------------|--|--------------------------------|--|

PS2X120-16-16 \$2,410



SPECIFICATIONS

Interior Dimensions: 33" x 17" x 10"
 Exterior Dimensions: 35 1/2" x 19 1/2"
 Minimum Cabinet Size: 39"
 Gauge: 16
 Weight: 38 lbs.
 Sound Dampening: Sound Pad and Spray Coat
 Stainless Finish: Diamond
 Corner Radius: 8mm
 Installation: Undermount with 1/2" Reveal

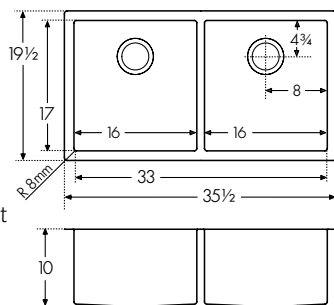

ACCESSORIES

- | | | | | | |
|--------------------------------------|-------------------------------------|-------------------------------|--|--------------------------------|--|
| 2 Bottom Grid PS2-16-36S | 3 Cutting Board PS2-45S | 4 Colander PE-70S | 5 Drain Cover RNDCVR (2) Included | 6 Roller Mat RM18S | 7 Strainer Basket 906 906SN |
|--------------------------------------|-------------------------------------|-------------------------------|--|--------------------------------|--|

ACCESSORIES

- | | | | |
|--|--|--|---|
| 1 Bottom Grid 13 1/2" x 16 1/2" Stainless PS2-14-36S \$140 | 2 Bottom Grid 15 1/2" x 16 1/2" Stainless PS2-16-36S \$150 | 3 Cutting Board 11" x 17 7/8" x 1" Maple PS2-45S \$230 | 4 Colander 6 1/8" x 17 5/8" x 2 1/8" Stainless PE-70S \$230 |
| 5 Drain Cover 4 1/2" Stainless RNDCVR \$90 Two included with each double bowl sink. | 6 Roller Mat 12 13/16" x 17 7/8" Stainless RM18S \$165 | 7 Strainer Basket Chrome 906 \$70 Satin Nickel 906SN \$95 | |

PERFECT TOGETHER

Professional Faucets

For the complete PROFESSIONAL Faucet Collection see page 199.



FF5300



FFPD5300



FFPD5400



Crystal

The Crystal sinks not only look stunning - especially when combined with the Crystal faucet - their **performance** and their **reliability** are even more impressive.

Behind the discreetly **elegant glass and stainless steel** is where the magic happens, that's when drains disappear, sinks get flat bottoms and faucets flow like waterfalls.



Pictured: CLV110-28 sink with FFPD4621 faucet

Crystal

1

Commercial Grade Stainless

Made of 16 gauge stainless steel with a Diamond finish that will retain its beauty for many years.



2

Removable Drain Cover

Shatterproof drain cover is easily removed for cleaning and sits perfectly in the sink to provide an even flat surface. Goodbye broken stemware.



3

Reversible Installation

Invisible drain is located on the side of the sink bowl and can be installed with either a left or right side drain hole (single bowl sinks only) while allowing for more room beneath the sink.



4

Sound Dampening System

Absorbs and reduces the noise caused by a garbage disposal or running water.



deco-inspired GLAMOUR

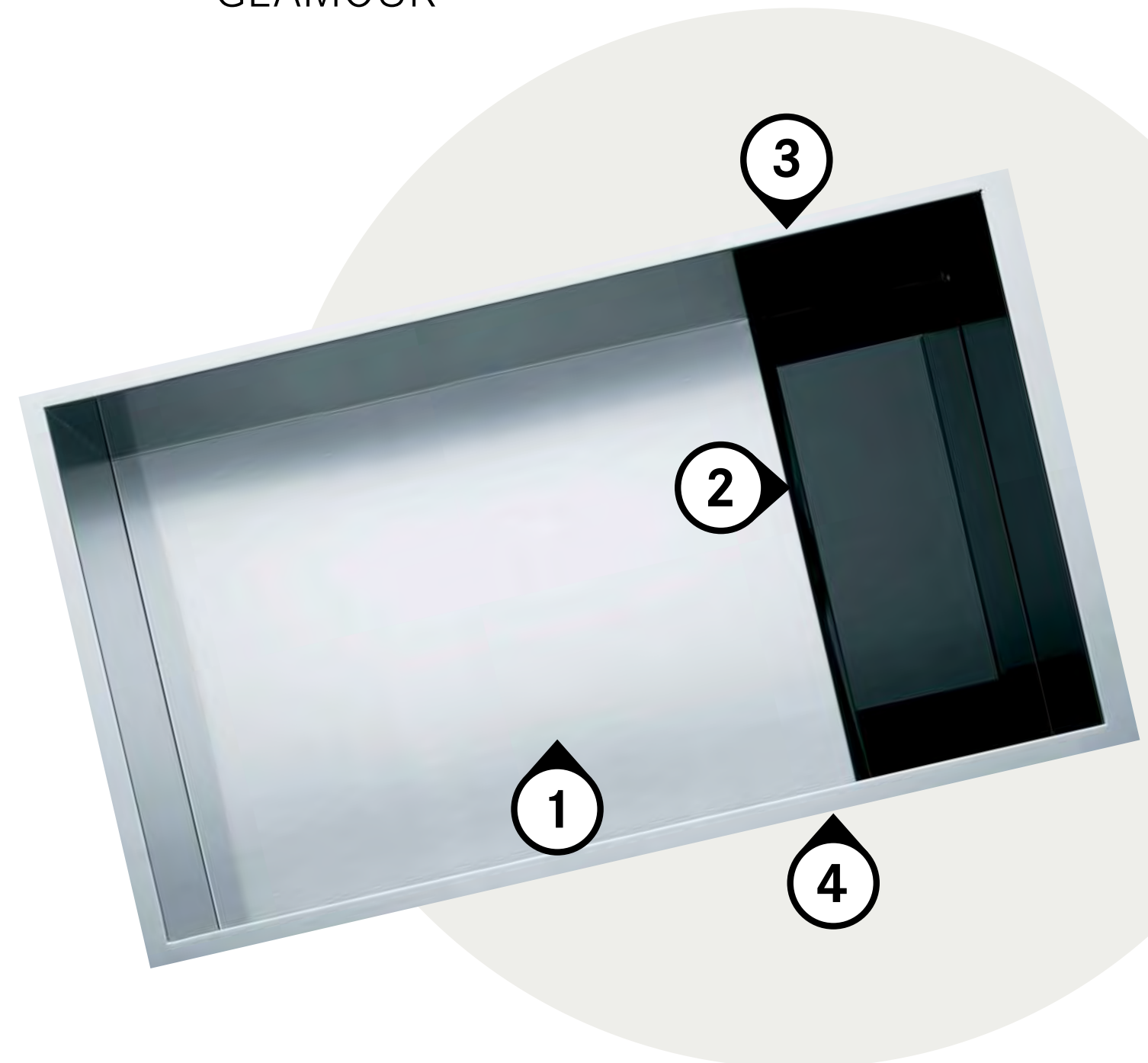

CLV110-24 \$1,695



SPECIFICATIONS

Interior Dimensions: 24½" x 17" x 9"
 Exterior Dimensions: 26½" x 19"
 Minimum Cabinet Size: 30"
 Gauge: 16
 Weight: 28 lbs.
 Sound Dampening: Sound Pad & Spray Coat
 Stainless Finish: Diamond
 Corner Radius: 0mm
 Installation: Undermount with ½" Reveal

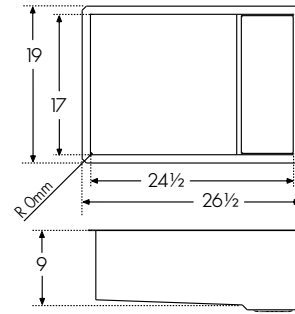

ACCESSORIES

- | | | | | | |
|-----------------------------------|-----------------------------------|-----------------------------|------------------------------|---|----------------------------|
| 2 Bottom Grid CL-24-36S | 5 Cutting Board PS2-45S | 6 Colander PE-70S | 7 Roller Mat RM18S | 8 Drain Cover CL-BGC Included CL-WGC CL-SSC | 9 Inox Cream 903 |
|-----------------------------------|-----------------------------------|-----------------------------|------------------------------|---|----------------------------|

CLV110-28 \$1,805

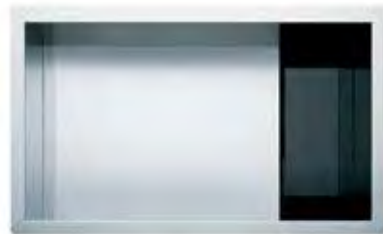

SPECIFICATIONS

Interior Dimensions: 27½" x 17" x 9"
 Exterior Dimensions: 29½" x 19"
 Minimum Cabinet Size: 33"
 Gauge: 16
 Weight: 31 lbs.
 Sound Dampening: Sound Pad & Spray Coat
 Stainless Finish: Diamond
 Corner Radius: 0mm
 Installation: Undermount with ½" Reveal

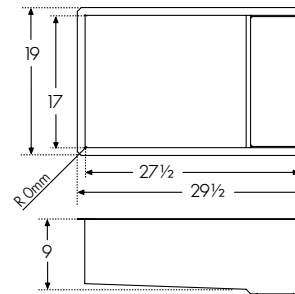

ACCESSORIES

- | | | | | | |
|-----------------------------------|-----------------------------------|-----------------------------|------------------------------|---|----------------------------|
| 3 Bottom Grid CL-28-36S | 5 Cutting Board PS2-45S | 6 Colander PE-70S | 7 Roller Mat RM18S | 8 Drain Cover CL-BGC Included CL-WGC CL-SSC | 9 Inox Cream 903 |
|-----------------------------------|-----------------------------------|-----------------------------|------------------------------|---|----------------------------|

CLV110-31 \$1,915



SPECIFICATIONS

Interior Dimensions: 30½" x 17" x 9"
 Exterior Dimensions: 32½" x 19"
 Minimum Cabinet Size: 36"
 Gauge: 16
 Weight: 34 lbs.
 Sound Dampening: Sound Pad & Spray Coat
 Stainless Finish: Diamond
 Corner Radius: 0mm
 Installation: Undermount with ½" Reveal

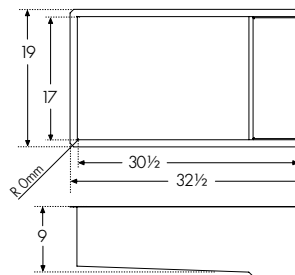

ACCESSORIES

- | | | | | | |
|-----------------------------------|-----------------------------------|-----------------------------|------------------------------|---|----------------------------|
| 4 Bottom Grid CL-31-36S | 5 Cutting Board PS2-45S | 6 Colander PE-70S | 7 Roller Mat RM18S | 8 Drain Cover CL-BGC Included CL-WGC CL-SSC | 9 Inox Cream 903 |
|-----------------------------------|-----------------------------------|-----------------------------|------------------------------|---|----------------------------|

CLV120-33 \$2,025



SPECIFICATIONS

Interior Dimensions: 30" x 17" x 9"
 Exterior Dimensions: 32½" x 19"
 Minimum Cabinet Size: 36"
 Gauge: 16
 Weight: 35 lbs.
 Sound Dampening: Sound Pad & Spray Coat
 Stainless Finish: Diamond
 Corner Radius: 0mm
 Installation: Undermount with ½" Reveal

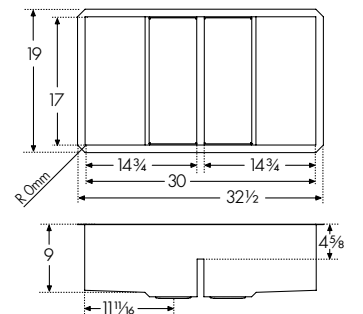

ACCESSORIES

- | | | | | | |
|-----------------------------------|-----------------------------------|-----------------------------|------------------------------|---|----------------------------|
| 1 Bottom Grid CL-14-36S | 5 Cutting Board PS2-45S | 6 Colander PE-70S | 7 Roller Mat RM18S | 8 Drain Cover CL-BGC Included CL-WGC CL-SSC | 9 Inox Cream 903 |
|-----------------------------------|-----------------------------------|-----------------------------|------------------------------|---|----------------------------|

ACCESSORIES

- | | | | | |
|--|---|--|--|---|
| 1 Bottom Grid 15" x 16¾" x 4¾" Stainless CL-14-36S \$165 | 2 Bottom Grid 16 1/16" x 16 1/8" Stainless CL-24-36S \$165 | 3 Bottom Grid 19 1/2" x 16 1/8" Stainless CL-28-36S \$175 | 4 Bottom Grid 22 3/4" x 16 1/8" Stainless CL-31-36S \$190 | 5 Cutting Board 11" x 17 7/8" x 1" Maple PS2-45S \$230 |
| 6 Colander 6 1/8" x 17 5/8" x 2 1/8" Stainless PE-70S \$230 | 7 Roller Mat 12 13/16" x 17 7/8" Stainless RM18S \$165 | 8 Drain Cover 6 1/4" x 16 7/8" Black CL-BGC PE-70S \$150 Included White CL-WGC \$150 Stainless Steel CL-SSC \$125 | 9 Inox Cream Stainless Steel Polish 903 \$35 | |

PERFECT TOGETHER

Crystal Faucet

For the complete CRYSTAL Faucet Collection see page 201.
 For dispenser details see page 256.



FFPD4600



SD2600



Pictured: PTX160-37 sink with FFPD4300 faucet

Pescara

Whether it's used in a kitchen, bar area, or prep area, Pescara is sure to be a head-turner. The **hidden drain** accents its **contemporary look**, while an **integrated ledge system** takes functionality to a whole new level. With three new double-bowl options, there's a Pescara sink for every cooking style.



Pescara

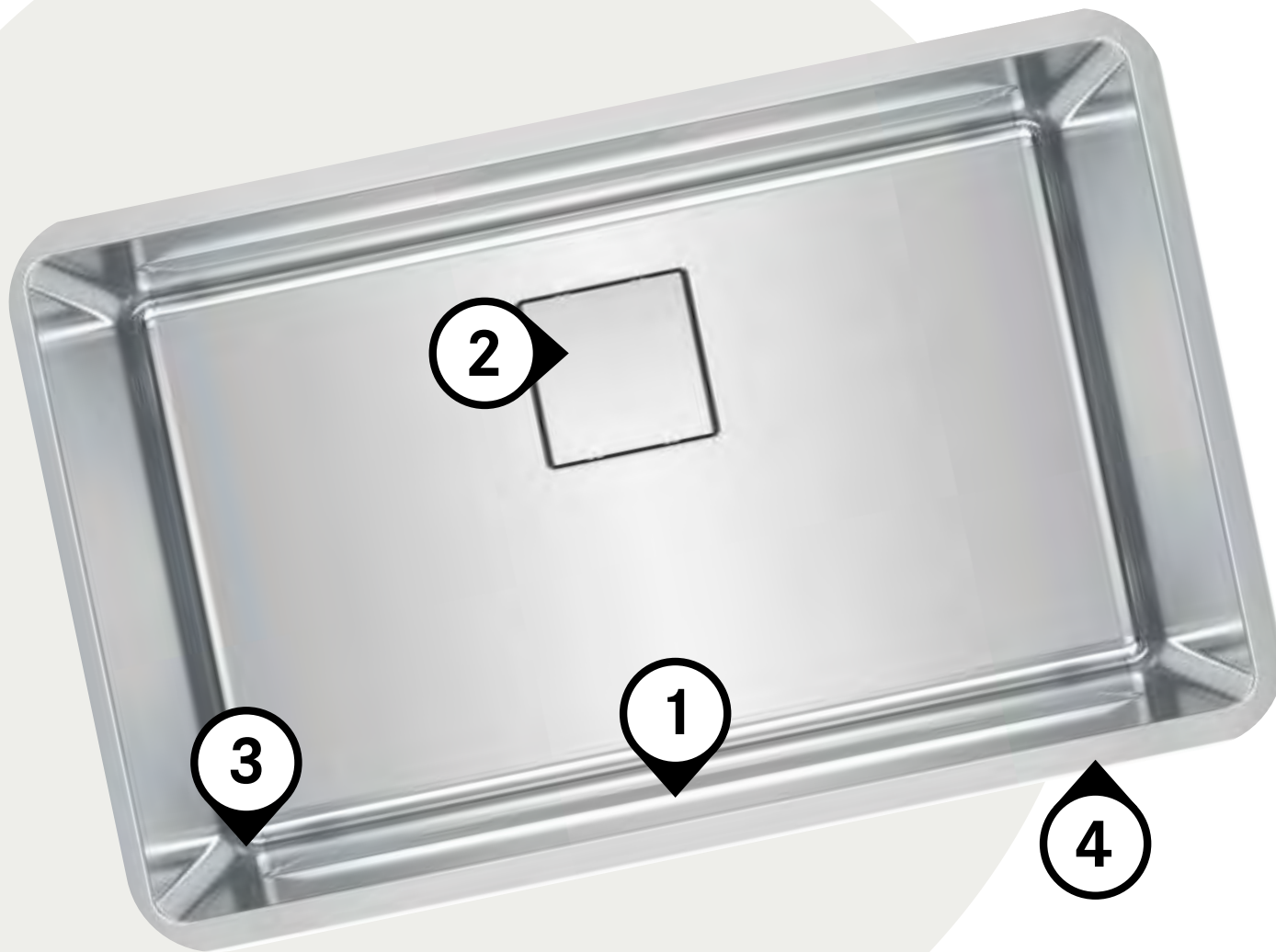

**detailed to
PERFECTION**

1

Integrated Ledge System

Shelf grid sits conveniently on the integrated ledge system, creating a higher level workspace. Expand your workspace when you prep, rinse and clean.



2

Concealed Drain

The removable drain cover conceals the drain for a seamless bowl surface, while providing a flat bottom surface to allow for more usable workspace.



3

Easy-Clean Corners

The 20mm radius corners make it easy to clean every part of the sink.



4

Sound Dampening System

Sound dampening pads and spray coat reduce excess noise from running water and disposal vibration.



PTX110-14 \$650



SPECIFICATIONS

Interior Dimensions: 13½" x 17" x 8"
 Exterior Dimensions: 14⅞" x 18⅜"
 Minimum Cabinet Size: 18"
 Gauge: 18
 Weight: 11 lbs.
 Sound Dampening: Sound Pad & Spray Coat
 Stainless Finish: Pearl
 Corner Radius: 20mm
 Installation: Undermount with 3mm Reveal

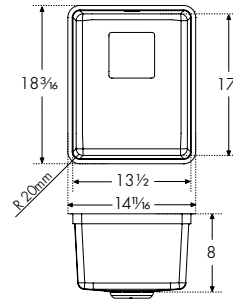

ACCESSORIES

| | | | | | | | | |
|----------------------------------|----------------------------------|---|----------------------------------|------------------------------|---|---|---|---|
| 1 Bottom Grid PT14-36S | 7 Cutting Board PT-40S | 8 Self Healing Cutting Mat SP-40S | 9 Cutting Board PT-41S | 10 Colander PE-70S | 11 Universal Roller Mat UV-36RM | 12 Push Button Strainer Kit 906P-C 906P-SN | 13 Strainer Basket 906 906SN | 14 Drain Cover PKGCVR Included |
|----------------------------------|----------------------------------|---|----------------------------------|------------------------------|---|---|---|---|

PTX110-17 \$740



SPECIFICATIONS

Interior Dimensions: 16⅞" x 17" x 8½"
 Exterior Dimensions: 17¾" x 18⅜"
 Minimum Cabinet Size: 21"
 Gauge: 18
 Weight: 14 lbs.
 Sound Dampening: Sound Pad & Spray Coat
 Stainless Finish: Pearl
 Integral Franke Ledge System
 Corner Radius: 20mm
 Installation: Undermount with 3mm Reveal

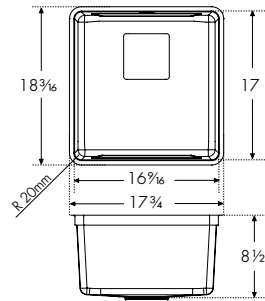

ACCESSORIES

| | | | | | | | | | |
|----------------------------------|---------------------------------|----------------------------------|---|----------------------------------|------------------------------|---|---|---|---|
| 2 Bottom Grid PT17-36S | 6 Shelf Grid PT14-31S | 7 Cutting Board PT-40S | 8 Self Healing Cutting Mat SP-40S | 9 Cutting Board PT-41S | 10 Colander PE-70S | 11 Universal Roller Mat UV-36RM | 12 Push Button Strainer Kit 906P-C 906P-SN | 13 Strainer Basket 906 906SN | 14 Drain Cover PKGCVR Included |
|----------------------------------|---------------------------------|----------------------------------|---|----------------------------------|------------------------------|---|---|---|---|

PTX110-20 \$960

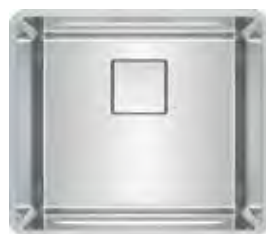

SPECIFICATIONS

Interior Dimensions: 19½" x 17" x 9"
 Exterior Dimensions: 20⅝" x 18⅜"
 Minimum Cabinet Size: 24"
 Gauge: 18
 Weight: 16 lbs.
 Sound Dampening: Sound Pad & Spray Coat
 Stainless Finish: Pearl
 Integral Franke Ledge System
 Corner Radius: 20mm
 Installation: Undermount with 3mm Reveal

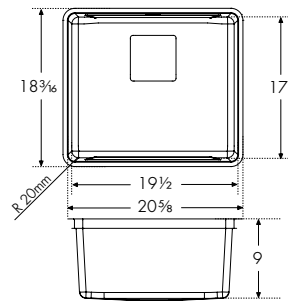

ACCESSORIES

| | | | | | | | | | |
|----------------------------------|---------------------------------|----------------------------------|---|----------------------------------|------------------------------|---|---|---|---|
| 3 Bottom Grid PT20-36S | 6 Shelf Grid PT14-31S | 7 Cutting Board PT-40S | 8 Self Healing Cutting Mat SP-40S | 9 Cutting Board PT-41S | 10 Colander PE-70S | 11 Universal Roller Mat UV-36RM | 12 Push Button Strainer Kit 906P-C 906P-SN | 13 Strainer Basket 906 906SN | 14 Drain Cover PKGCVR Included |
|----------------------------------|---------------------------------|----------------------------------|---|----------------------------------|------------------------------|---|---|---|---|

PTX110-22 \$1,070

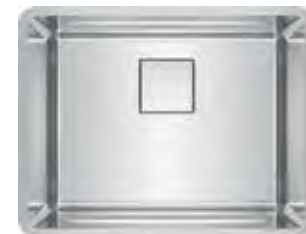

SPECIFICATIONS

Interior Dimensions: 22⅞" x 17" x 9½"
 Exterior Dimensions: 23⅝" x 18½"
 Minimum Cabinet Size: 27"
 Gauge: 18
 Weight: 18 lbs.
 Sound Dampening: Sound Pad & Spray Coat
 Stainless Finish: Pearl
 Integral Franke Ledge System
 Corner Radius: 20mm
 Installation: Undermount with 3mm Reveal

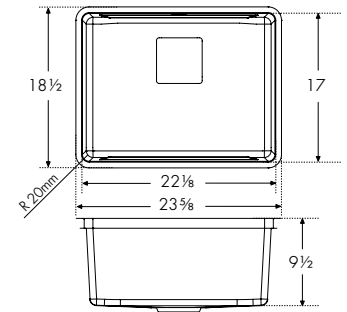

ACCESSORIES

| | | | | | | | | | |
|----------------------------------|---------------------------------|----------------------------------|---|----------------------------------|------------------------------|---|---|---|---|
| 4 Bottom Grid PT22-36S | 6 Shelf Grid PT14-31S | 7 Cutting Board PT-40S | 8 Self Healing Cutting Mat SP-40S | 9 Cutting Board PT-41S | 10 Colander PE-70S | 11 Universal Roller Mat UV-36RM | 12 Push Button Strainer Kit 906P-C 906P-SN | 13 Strainer Basket 906 906SN | 14 Drain Cover PKGCVR Included |
|----------------------------------|---------------------------------|----------------------------------|---|----------------------------------|------------------------------|---|---|---|---|

PTX110-25 \$1,125

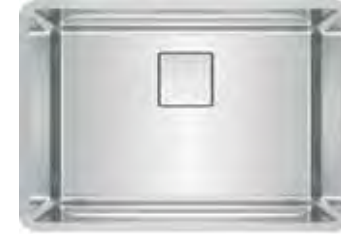

SPECIFICATIONS

Interior Dimensions: 25" x 17" x 9½"
 Exterior Dimensions: 26½" x 18½"
 Minimum Cabinet Size: 30"
 Gauge: 18
 Weight: 20 lbs.
 Sound Dampening: Sound Pad & Spray Coat
 Stainless Finish: Pearl
 Integral Franke Ledge System
 Corner Radius: 20mm
 Installation: Undermount with 3mm Reveal

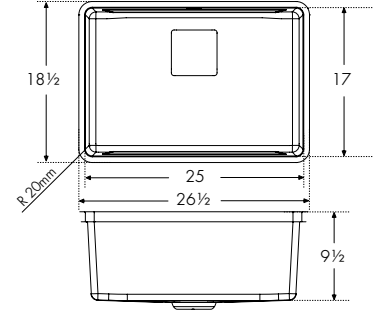

ACCESSORIES

| | | | | | | | | | |
|----------------------------------|---------------------------------|----------------------------------|---|----------------------------------|------------------------------|---|---|---|---|
| 5 Bottom Grid PT25-36S | 6 Shelf Grid PT14-31S | 7 Cutting Board PT-40S | 8 Self Healing Cutting Mat SP-40S | 9 Cutting Board PT-41S | 10 Colander PE-70S | 11 Universal Roller Mat UV-36RM | 12 Push Button Strainer Kit 906P-C 906P-SN | 13 Strainer Basket 906 906SN | 14 Drain Cover PKGCVR Included |
|----------------------------------|---------------------------------|----------------------------------|---|----------------------------------|------------------------------|---|---|---|---|

ACCESSORIES

| | | | | | | |
|--|--|---|--|---|---|--|
| 1 Bottom Grid 12⅝" x 15⅜" Stainless PT14-36S \$150 | 2 Bottom Grid 15⅜" x 15⅜" Stainless PT17-36S \$150 | 3 Bottom Grid 18⅝" x 15⅜" Stainless PT20-36S \$165 | 4 Bottom Grid 20⅝" x 15⅜" Stainless PT22-36S \$165 | 5 Bottom Grid 23⅜" x 15⅜" Stainless PT25-36S \$165 | 6 Shelf Grid 14" x 16¼" Stainless PT14-31S \$150 | 7 Cutting Board 10⅞" x 18½" Tempered Glass PT-40S \$220 |
| 8 Self Healing Cutting Mat 9⅜" x 14⅞" Silicone SP-40S \$60 | 9 Cutting Board 11" x 18½" Solid Wood PT-41S \$210 | 10 Colander 6⅞" x 17⅝" x 2⅞" Stainless PE-70S \$230 | 11 Universal Roller Mat 18⅞" x 20" Stainless UV-36RM \$175 | 12 Push Button Strainer Kit Chrome 906P-C \$135 Satin Nickel 906P-SN \$160 | 13 Strainer Basket Chrome 906 \$70 Satin Nickel 906SN \$95 | 14 Drain Cover Stainless PKGCVR \$90 (One included with each sink) |

PTX110-28 \$1,200



SPECIFICATIONS

Interior Dimensions: 28" x 17" x 9½"
 Exterior Dimensions: 29½" x 18½"
 Minimum Cabinet Size: 33"
 Gauge: 18
 Weight: 21 lbs.
 Sound Dampening: Sound Pad & Spray Coat
 Stainless Finish: Pearl
 Integral Franke Ledge System
 Corner Radius: 20mm
 Installation: Undermount with 3mm Reveal

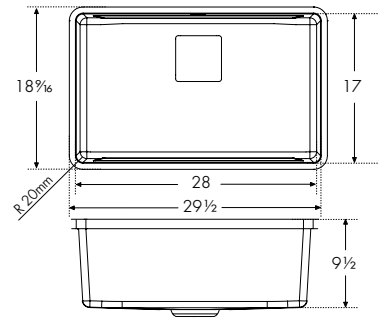

ACCESSORIES

| | | | | | | | | | | | | | | | | | | | |
|---|--------------------------------|---|-------------------------------|---|--------------------------------|---|---|---|--------------------------------|----|---------------------------|----|--|----|--|----|--|----|--|
| 4 | Bottom Grid PT28-36S | 6 | Shelf Grid PT14-31S | 7 | Cutting Board PT-40S | 8 | Self Healing Cutting Mat SP-40S | 9 | Cutting Board PT-41S | 10 | Colander PE-70S | 11 | Universal Roller Mat UV-36RM | 12 | Push Button Strainer Kit 906P-C 906P-SN | 13 | Strainer Basket 906 906SN | 14 | Drain Cover PKGCVR Included |
|---|--------------------------------|---|-------------------------------|---|--------------------------------|---|---|---|--------------------------------|----|---------------------------|----|--|----|--|----|--|----|--|

PTX110-31 \$1,315



SPECIFICATIONS

Interior Dimensions: 31" x 17" x 9½"
 Exterior Dimensions: 32½" x 18½"
 Minimum Cabinet Size: 36"
 Gauge: 18
 Weight: 23 lbs.
 Sound Dampening: Sound Pad & Spray Coat
 Stainless Finish: Silk
 Integral Franke Ledge System
 Corner Radius: 20mm
 Installation: Undermount with 3mm Reveal

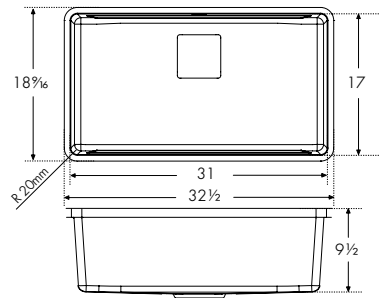

ACCESSORIES

| | | | | | | | | | | | | | | | | | | | |
|---|--------------------------------|---|-------------------------------|---|--------------------------------|---|---|---|--------------------------------|----|---------------------------|----|--|----|--|----|--|----|--|
| 5 | Bottom Grid PT31-36S | 6 | Shelf Grid PT14-31S | 7 | Cutting Board PT-40S | 8 | Self Healing Cutting Mat SP-40S | 9 | Cutting Board PT-41S | 10 | Colander PE-70S | 11 | Universal Roller Mat UV-36RM | 12 | Push Button Strainer Kit 906P-C 906P-SN | 13 | Strainer Basket 906 906SN | 14 | Drain Cover PKGCVR Included |
|---|--------------------------------|---|-------------------------------|---|--------------------------------|---|---|---|--------------------------------|----|---------------------------|----|--|----|--|----|--|----|--|

NEW PTX160-31 \$1,500



SPECIFICATIONS

Interior Dimensions: 31" x 17" x 8½" & 8"
 Exterior Dimensions: 32" x 18"
 Minimum Cabinet Size: 36"
 Gauge: 18
 Weight: 20.5 lbs.
 Sound Dampening: Sound Pad & Spray Coat
 Stainless Finish: Pearl
 Integral Franke Ledge System
 Corner Radius: 20mm
 Installation: Undermount with 3mm Reveal

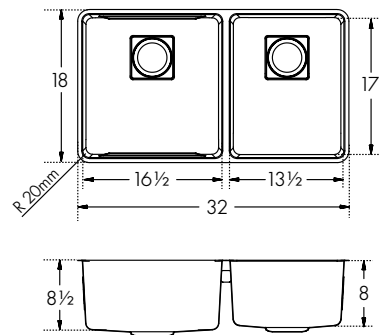

ACCESSORIES

| | | | | | | | | | | | | | | | | | | | | | |
|---|--------------------------------|---|--------------------------------|---|-------------------------------|---|--------------------------------|---|---|---|--------------------------------|----|---------------------------|----|--|----|--|----|--|----|--|
| 1 | Bottom Grid PT14-36S | 2 | Bottom Grid PT17-36S | 6 | Shelf Grid PT14-31S | 7 | Cutting Board PT-40S | 8 | Self Healing Cutting Mat SP-40S | 9 | Cutting Board PT-41S | 10 | Colander PE-70S | 11 | Universal Roller Mat UV-36RM | 12 | Push Button Strainer Kit 906P-C 906P-SN | 13 | Strainer Basket 906 906SN | 14 | Drain Cover PKGCVR Included |
|---|--------------------------------|---|--------------------------------|---|-------------------------------|---|--------------------------------|---|---|---|--------------------------------|----|---------------------------|----|--|----|--|----|--|----|--|

NEW PTX160-37 \$1,550

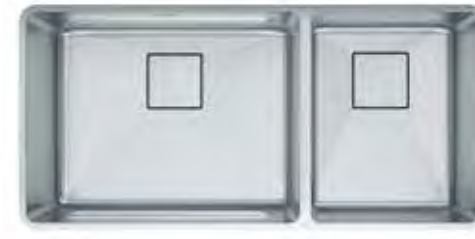

SPECIFICATIONS

Interior Dimensions: 36½" x 17" x 9½" & 8"
 Exterior Dimensions: 38" x 18"
 Minimum Cabinet Size: 42"
 Gauge: 18
 Weight: 25.4 lbs.
 Sound Dampening: Sound Pad & Spray Coat
 Stainless Finish: Pearl
 Integral Franke Ledge System
 Corner Radius: 20mm
 Installation: Undermount with 3mm Reveal

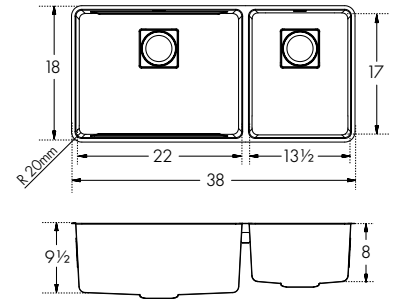

ACCESSORIES

| | | | | | | | | | | | | | | | | | | | | | |
|---|--------------------------------|---|--------------------------------|---|-------------------------------|---|--------------------------------|---|---|---|--------------------------------|----|---------------------------|----|--|----|--|----|--|----|--|
| 1 | Bottom Grid PT14-36S | 3 | Bottom Grid PT22-36S | 6 | Shelf Grid PT14-31S | 7 | Cutting Board PT-40S | 8 | Self Healing Cutting Mat SP-40S | 9 | Cutting Board PT-41S | 10 | Colander PE-70S | 11 | Universal Roller Mat UV-36RM | 12 | Push Button Strainer Kit 906P-C 906P-SN | 13 | Strainer Basket 906 906SN | 14 | Drain Cover PKGCVR Included |
|---|--------------------------------|---|--------------------------------|---|-------------------------------|---|--------------------------------|---|---|---|--------------------------------|----|---------------------------|----|--|----|--|----|--|----|--|

NEW PTX160-40 \$1,650

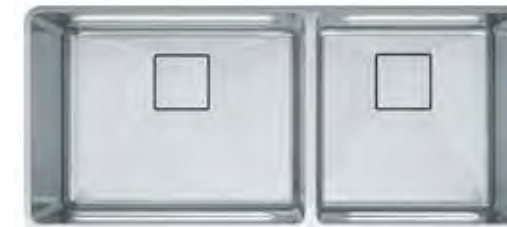

SPECIFICATIONS

Interior Dimensions: 39½" x 17" x 9½" & 8½"
 Exterior Dimensions: 41" x 18"
 Minimum Cabinet Size: 45"
 Gauge: 18
 Weight: 27.2 lbs.
 Sound Dampening: Sound Pad & Spray Coat
 Stainless Finish: Pearl
 Integral Franke Ledge System
 Corner Radius: 20mm
 Installation: Undermount with 3mm Reveal

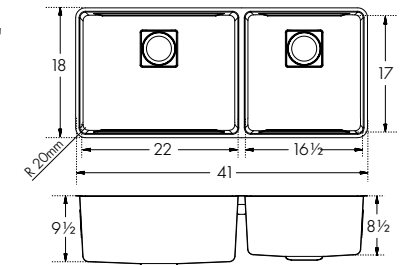

ACCESSORIES

| | | | | | | | | | | | | | | | | | | | | | |
|---|--------------------------------|---|--------------------------------|---|-------------------------------|---|--------------------------------|---|---|---|--------------------------------|----|---------------------------|----|--|----|--|----|--|----|--|
| 2 | Bottom Grid PT17-36S | 3 | Bottom Grid PT22-36S | 6 | Shelf Grid PT14-31S | 7 | Cutting Board PT-40S | 8 | Self Healing Cutting Mat SP-40S | 9 | Cutting Board PT-41S | 10 | Colander PE-70S | 11 | Universal Roller Mat UV-36RM | 12 | Push Button Strainer Kit 906P-C 906P-SN | 13 | Strainer Basket 906 906SN | 14 | Drain Cover PKGCVR Included |
|---|--------------------------------|---|--------------------------------|---|-------------------------------|---|--------------------------------|---|---|---|--------------------------------|----|---------------------------|----|--|----|--|----|--|----|--|

ACCESSORIES

| | | | | | | | | | | | | | | | | | | | | | | | | | | | |
|---|--|---|---|---|---|---|---|---|---|---|--|---|--|---|---|---|--|----|--|----|---|----|--|----|--|----|---|
| 1 | Bottom Grid 12 9/16" x 15 13/16" Stainless PT14-36S \$150 | 2 | Bottom Grid 15 3/8" x 15 13/16" Stainless PT17-36S \$150 | 3 | Bottom Grid 20 15/16" x 15 13/16" Stainless PT22-36S \$165 | 4 | Bottom Grid 26 3/4" x 15 13/16" Stainless PT28-36S \$175 | 5 | Bottom Grid 29 13/16" x 15 13/16" Stainless PT31-36S \$190 | 6 | Shelf Grid 14" x 16 1/4" Stainless PT14-31S \$150 | 7 | Cutting Board 10 7/8" x 18 1/2" Tempered Glass PT-40S \$220 | 8 | Self Healing Cutting Mat 9 13/16" x 14 7/8" Silicone SP-40S \$60 | 9 | Cutting Board 11" x 18 1/2" Solid Wood PT-41S \$210 | 10 | Colander 6 1/8" x 17 5/8" x 2 1/8" Stainless PE-70S \$230 | 11 | Universal Roller Mat 18 7/8" x 20" Stainless UV-36RM \$175 | 12 | Push Button Strainer Kit Chrome 906P-C \$135 Satin Nickel 906P-SN \$160 | 13 | Strainer Basket Chrome 906 \$70 Satin Nickel 906SN \$95 | 14 | Drain Cover Stainless PKGCVR \$90 (One included with each sink. Two included with double bowl) |
|---|--|---|---|---|---|---|---|---|---|---|--|---|--|---|---|---|--|----|--|----|---|----|--|----|--|----|---|

PERFECT TOGETHER

Pescara Faucets

For the complete PESCARA Faucet Collection see pages 212-214.



FFPD4300



FF4800



FF4400

Extended View



PFD4400



FFP4400



DW16000



Pictured: PTX110-25 sink with FF4420 faucet

Orca 2.0

Orca 2.0 offers the size advantage of a commercial sink with a **modern design** that is at home in today's luxury kitchen. Spacious Orca 2.0 accommodates large cookware and big tasks, while the optional shelf grid roller mat and wire basket that fit the integral ledge make this sink a high performer.

Designed with gentle curves and a rear drain with a smooth round cover, Orca 2.0 is easy to maintain and **offers enduring visual appeal**. Complete your workstation by adding a solid wood cutting board, a stainless steel colander and a roller mat to **make every meal you prepare effortless**.



Pictured: OR2X110 sink with FF3450 faucet

Orca 2.0

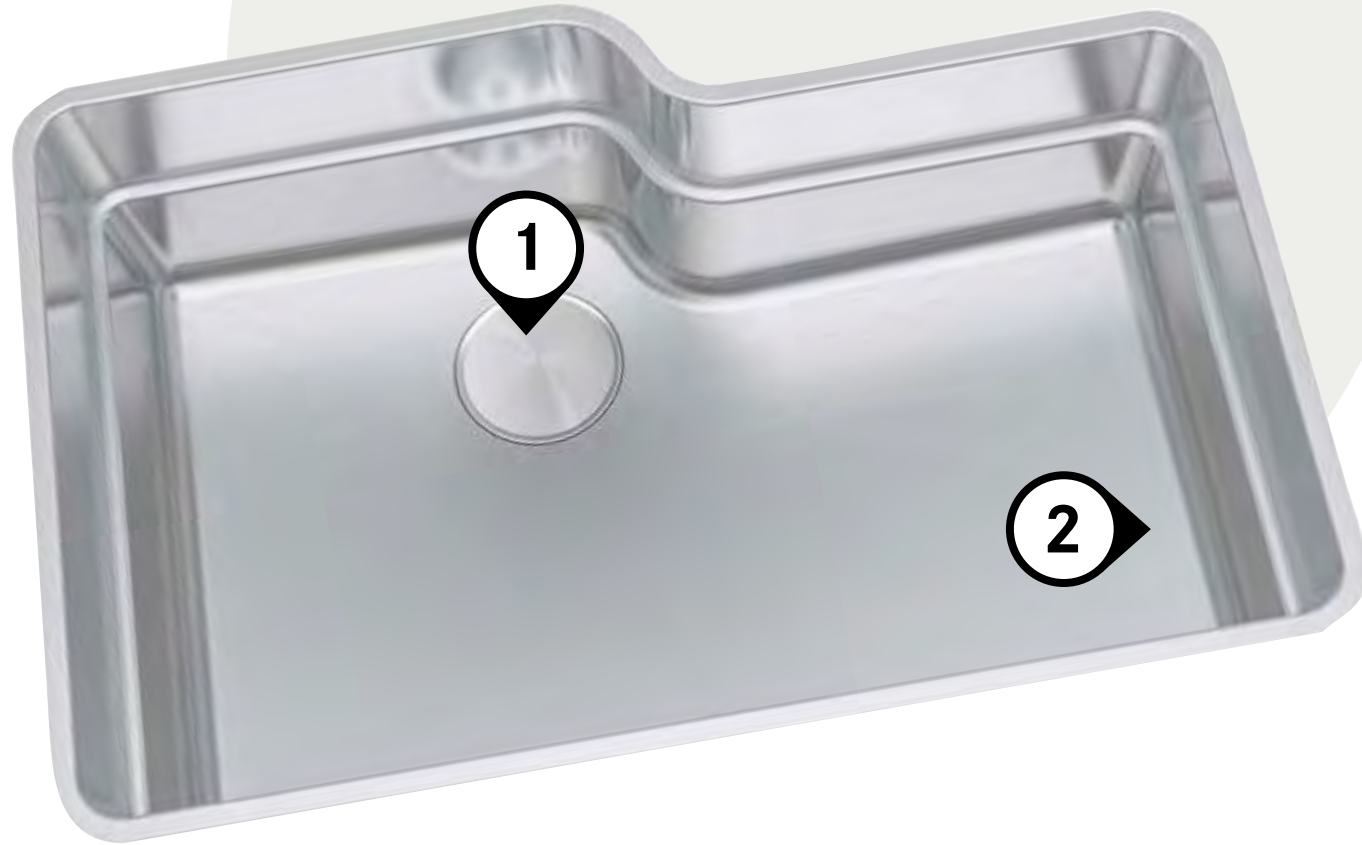

1

Drain Cover

Covers the drain to maintain an even surface of the basin. Goodbye, broken stemware.



2

Kitchen Essentials

Custom-fit accessories made to work together and turn the sink into a multi-purpose workstation.



OR2X110 \$1,090



SPECIFICATIONS



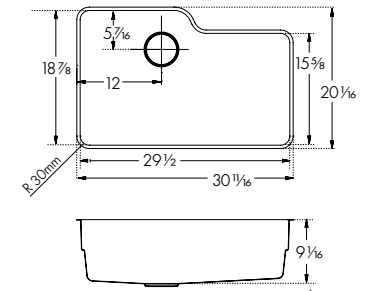





Interior Dimensions: 29 1/2" x 18 7/8" x 9 1/16"
 Exterior Dimensions: 30 1/16" x 20 1/16"
 Minimum Cabinet Size: 36"
 Gauge: 18
 Weight: 24 lbs.
 Sound Dampening: Sound Pad & Spray Coat
 Stainless Finish: Silk
 Integral Franke Ledge System
 Corner Radius: 30mm
 Installation: Undermount



ACCESSORIES

| | | | | | | | | | | | | | | | |
|---|-------------------------------|---|--|---|----------------------------------|---|-------------------------------|---|----------------------------|---|--|---|--|---|--------------------------|
| 1 | Bottom Grid OC2-36S | 2 | Shelf Grid Roller Mat OC2-31S-RH | 3 | Cutting Board OC2-45SP | 4 | Wire Basket OC2-50C | 5 | Colander OC2-60S | 6 | Drain Cover RNDCVR Included | 7 | Strainer Basket 906 906SN | 8 | Inox Cream 903 |
|---|-------------------------------|---|--|---|----------------------------------|---|-------------------------------|---|----------------------------|---|--|---|--|---|--------------------------|

ACCESSORIES

| | | | |
|---|--|--|--|
|  |  |  |  |
| 1 Bottom Grid 27 7/16" x 16 3/4" Stainless OC2-36S \$235 | 2 Shelf Grid Roller Mat 10 1/2" x 15 3/8" Stainless OC2-31S-RH \$170 | 3 Cutting Board 17 1/8" x 19 13/16" Solid Wood with Stainless Colander OC2-45SP \$355 | 4 Wire Basket 13 3/8" x 18 1/2" x 2 5/8" Stainless OC2-50C \$170 |
|  |  |  |  |
| 5 Colander 7" x 12 1/2" x 2 1/2" Polished Stainless OC2-60S \$135 | 6 Drain Cover 4 1/2" Stainless RNDCVR \$90 One included with each sink. | 7 Strainer Basket Chrome 906 \$70 Satin Nickel 906SN \$95 | 8 Inox Cream Stainless Steel Polish 903 \$35 |



Pictured: PRX11021 sink with FF3450 faucet and SD-580N soap dispenser



Prestige

You'll be amazed by the volume that the **deep-bowl** Prestige sink can handle. The PRX11021 model features a **ledge system** for added convenience and **ergonomic** ease of use. A final Silk finish after production creates a **sleek glistening surface**, resulting in a beautiful finish that is hygienic and easy to clean.

Prestige



1

Sound Dampening

Sound pads and a spray coating absorb and reduce noise.



2

2

Hygienic Silk Finish

A glistening surface resulting in a beautiful finish that is hygienic and easy to clean.

1



PCX1102109 \$740



SPECIFICATIONS

Interior Dimensions: 21 1/4" x 18 7/8" x 9 1/16"
 Exterior Dimensions: 22 1/4" x 19 7/8"
 Minimum Cabinet Size: 27"
 Gauge: 18
 Weight: 20 lbs.
 Sound Dampening: Sound Pad & Spray Coat
 Stainless Finish: Silk
 Corner Radius: 83mm
 Installation: Undermount

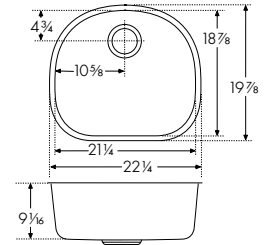

ACCESSORIES

| | | | | | | | | | |
|---|------------------------------|---|--|---|---|---|--|---|--------------------------|
| 1 | Bottom Grid PR-36S | 3 | Universal Roller Mat UV-36RM | 4 | Pop-Up Strainer 900P 900P-SN27 | 5 | Strainer Basket 906 906SN | 6 | Inox Cream 903 |
|---|------------------------------|---|--|---|---|---|--|---|--------------------------|

PRX11021 \$850



SPECIFICATIONS

Interior Dimensions: 21 1/4" x 18 7/8" x 9 1/16"
 Exterior Dimensions: 22 1/4" x 19 7/8"
 Minimum Cabinet Size: 27"
 Gauge: 18
 Weight: 20 lbs.
 Sound Dampening: Sound Pad & Spray Coat
 Stainless Finish: Silk
 Integral Franke Ledge System
 Corner Radius: 83mm
 Installation: Undermount

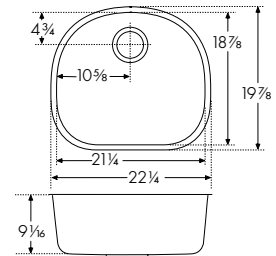

ACCESSORIES

| | | | | | | | | | | | |
|---|------------------------------|---|-----------------------------|---|--|---|---|---|--|---|--------------------------|
| 1 | Bottom Grid PR-36S | 2 | Shelf Grid PR-31S | 3 | Universal Roller Mat UV-36RM | 4 | Pop-Up Strainer 900P 900P-SN27 | 5 | Strainer Basket 906 906SN | 6 | Inox Cream 903 |
|---|------------------------------|---|-----------------------------|---|--|---|---|---|--|---|--------------------------|

ACCESSORIES

| | | | | | | | | | | | |
|---|--|---|---|---|---|---|---|---|--|---|--|
| 1 | Bottom Grid 18 13/32" x 16 3/8" Stainless PR-36S \$165 | 2 | Shelf Grid 20 3/16" x 13 7/16" Stainless PR-31S \$165 | 3 | Universal Roller Mat 18 7/16" x 20" Stainless UV-36RM \$175 | 4 | Pop-Up Strainer Chrome 900P \$125 Satin Nickel 900P-SN27 \$150 | 5 | Strainer Basket Chrome 906 \$70 Satin Nickel 906SN \$95 | 6 | Inox Cream Stainless Steel Polish 903 \$35 |
|---|--|---|---|---|---|---|---|---|--|---|--|

Regatta

The innovative design of the Regatta offers **large bowls** while remaining space conscious. A final Silk finish after production creates a **sleek glistening surface**, resulting in a beautiful finish that is hygienic and easy to clean.



Pictured: RGX160 sink with FF3180 faucet

Regatta



1

Rear Drain

Maximizes the usable bottom surface of the bowl while also creating extra cabinet space beneath the sink.



2

Multiple Bowl

A multiple bowl sink provides convenience so you can stack dishes in one sink while prepping in the other.



RGX160 \$1,060



SPECIFICATIONS



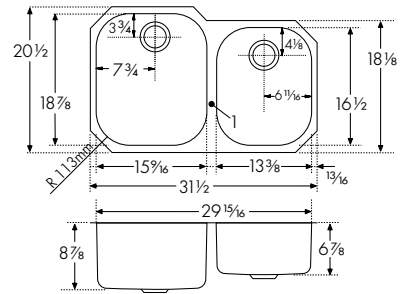



Interior Dimensions: 29 15/16" x 18 7/8" x 8 7/8" & 6 7/8"
 Exterior Dimensions: 31 1/2" x 20 1/2"
 Minimum Cabinet Size: 36"
 Gauge: 18
 Weight: 24 lbs.
 Sound Dampening: Sound Pad & Spray Coat
 Stainless Finish: Silk
 Corner Radius: 113mm
 Installation: Undermount



ACCESSORIES

| | | | | | | | | | | | | | |
|---|------------------------------|---|---------------------------------|---|-------------------------------------|---|--|---|---|---|--|---|--------------------------|
| 1 | Bottom Grid RG-36S | 2 | Bottom Grid RG-36S-RH | 3 | Small Drain Basket CP-50C | 4 | Universal Roller Mat UV-36RM | 5 | Pop-Up Strainer 900P 900P-SN27 | 6 | Strainer Basket 906 906SN | 7 | Inox Cream 903 |
|---|------------------------------|---|---------------------------------|---|-------------------------------------|---|--|---|---|---|--|---|--------------------------|

ACCESSORIES

| | | | |
|---|--|--|---|
|  |  |  |  |
| 1 Bottom Grid 13" x 16 7/16" Stainless RG-36S \$165 | 2 Bottom Grid 11 1/2" x 14 1/4" Stainless RG-36S-RH \$165 | 3 Small Drain Basket 15 3/8" x 12 1/2" Coated Stainless CP-50C \$280 | 4 Universal Roller Mat 18 7/16" x 20" Stainless UV-36RM \$175 |
|  |  |  | |
| 5 Pop-Up Strainer Chrome 900P \$125 Satin Nickel 900P-SN27 \$150 | 6 Strainer Basket Chrome 906 \$70 Satin Nickel 906SN \$95 | 7 Inox Cream Stainless Steel Polish 903 \$35 | |



Pictured: CUX120 sink with FF3325BSS faucet

Cube

With the modern **18 gauge stainless steel** design of the Cube family, this **Swiss engineered** line of sinks has it all. The **single and double bowl** styles offer a clean, sleek look with an easy-to-clean **Pearl finish**. **ADA compliant** sinks are available to accommodate your task.



Cube

1

Optimal Radius Design

The radius of the sink is simple and contemporary and is easy to clean.



2

Deep Capacity Bowl

A large deep bowl makes it easy to clean cookware items and minimizes splashing, offering the form and function you expect from your sink.



3

Efficient Drain

The pitched bottom creates efficient draining and the rear drain placement provides additional storage below the sink.



4

Pearl Finish

A durable, resilient finish that will stand up to heavy everyday use.



wonderfully
MODERN



CUX11010-W \$1,860



Note:
Included accessories
are meant to work on
the counter or with the
balance of the Cube sinks.

SPECIFICATIONS

Interior Dimensions: 10⁵/₈" x 18⁷/₈" x 8¹/₁₆"
Exterior Dimensions: 13¹/₈" x 21³/₈"
Minimum Cabinet Size: 18"
Gauge: 19
Weight: 19 lbs.
Sound Dampening: Sound Pad
Stainless Finish: Diamond
Corner Radius: 12mm
Installation: Undermount with 1/2" Reveal

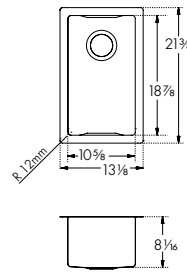

ACCESSORIES

- | | | | | | | | | | |
|--|--|--|--|---|---|---|--|--|---|
| 4 Cutting Board CU-40S Included | 5 Cutting Board CU-40P Included | 6 Cutting Mat SP-40S Included | 7 Glass Cover/ Cutting Board CU-GC Included | 8 Knife Holder + Cutting Board CU-40K Included | 9 Knife Set CU-KS Included | 10 Colander CUW-70S Included | 11 Wire Rack CU-WR Included | 12 Frame Cover CU-FC Included | 15 Strainer Basket 906 906SN |
|--|--|--|--|---|---|---|--|--|---|

CUX11015 \$675



SPECIFICATIONS

Interior Dimensions: 15" x 16¹/₈" x 9"
Exterior Dimensions: 16¹/₂" x 17³/₄"
Minimum Cabinet Size: 21"
Gauge: 18
Weight: 13 lbs.
Sound Dampening: Sound Pad & Spray Coat
Stainless Finish: Pearl
Corner Radius: 12mm
Installation: Undermount

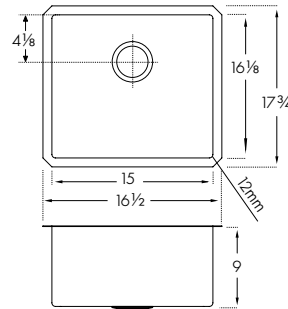

ACCESSORIES

- | | | | | | | | |
|------------------------------------|------------------------------------|------------------------------------|---------------------------------|---|---|---|-------------------------------|
| 1 Bottom Grid CU15-36S | 4 Cutting Board CU-40S | 5 Cutting Board CU-40P | 10 Colander CUW-70S | 13 Universal Roller Mat UV-36RM | 14 Push Button Strainer Kit 906P-C 906P-SN | 15 Strainer Basket 906 906SN | 16 Inox Cream 903 |
|------------------------------------|------------------------------------|------------------------------------|---------------------------------|---|---|---|-------------------------------|

NEW CUX11019 \$715



SPECIFICATIONS

Interior Dimensions: 18" x 16¹/₈" x 9"
Exterior Dimensions: 19¹/₁₆" x 17³/₄"
Minimum Cabinet Size: 24"
Gauge: 18
Weight: 23 lbs.
Sound Dampening: Sound Pad & Spray Coat
Stainless Finish: Pearl
Corner Radius: 12mm
Installation: Undermount

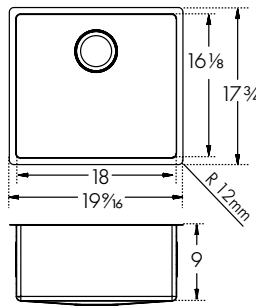

ACCESSORIES

- | | | | | | | | |
|------------------------------------|------------------------------------|------------------------------------|---------------------------------|---|---|---|-------------------------------|
| 2 Bottom Grid CU19-36S | 4 Cutting Board CU-40S | 5 Cutting Board CU-40P | 10 Colander CUW-70S | 13 Universal Roller Mat UV-36RM | 14 Push Button Strainer Kit 906P-C 906P-SN | 15 Strainer Basket 906 906SN | 16 Inox Cream 903 |
|------------------------------------|------------------------------------|------------------------------------|---------------------------------|---|---|---|-------------------------------|

CUX11021 \$790



SPECIFICATIONS

Interior Dimensions: 21¹/₄" x 16¹/₈" x 9"
Exterior Dimensions: 22³/₄" x 17³/₄"
Minimum Cabinet Size: 27"
Gauge: 18
Weight: 16 lbs.
Sound Dampening: Sound Pad & Spray Coat
Stainless Finish: Pearl
Corner Radius: 12mm
Installation: Undermount

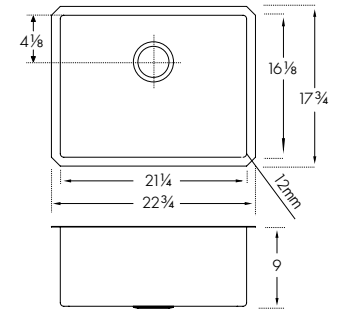

ACCESSORIES

- | | | | | | | | |
|------------------------------------|------------------------------------|------------------------------------|---------------------------------|---|---|---|-------------------------------|
| 3 Bottom Grid CU21-36S | 4 Cutting Board CU-40S | 5 Cutting Board CU-40P | 10 Colander CUW-70S | 13 Universal Roller Mat UV-36RM | 14 Push Button Strainer Kit 906P-C 906P-SN | 15 Strainer Basket 906 906SN | 16 Inox Cream 903 |
|------------------------------------|------------------------------------|------------------------------------|---------------------------------|---|---|---|-------------------------------|

ACCESSORIES

- | | | | | | |
|---|--|--|--|---|--|
| 1 Bottom Grid 13 ³ / ₄ " x 15 ³ / ₈ " Stainless CU15-36S \$135 | 2 Bottom Grid 17 ¹⁵ / ₃₂ " x 15 ¹ / ₂ " Stainless CU19-36S \$140 | 3 Bottom Grid 20 ³ / ₈ " x 15 ³ / ₈ " Stainless CU21-36S \$150 | 4 Cutting Board 7 ¹ / ₁₆ " x 16 ⁷ / ₈ " Walnut CU-40S \$160 Included with CUX11010-W | 5 Cutting Board 7 ¹ / ₁₆ " x 16 ⁷ / ₈ " Black Plastic CU-40P \$105 Included with CUX11010-W | 6 Cutting Mat 11 ¹ / ₄ " x 17 ³ / ₄ " Silicone SP-40S \$60 Included with CUX11010-W |
| 7 Glass Cover/ Cutting Board 11 ¹ / ₂ " x 19 ³ / ₄ " Black Glass CU-GC \$125 Included with CUX11010-W | 8 Knife Holder+ Cutting Board 7 ³ / ₁₆ " x 16 ⁷ / ₈ " Walnut CU-40K \$255 Included with CUX11010-W | 9 Knife Set Set of 3 Black CU-KS \$105 Included with CUX11010-W | 10 Colander 6 ³ / ₁₆ " x 17 ⁵ / ₈ " x 2 ¹ / ₈ " Stainless CUW-70S \$210 Included with CUX11010-W | 11 Wire Rack 11" x 18 ³ / ₄ " Stainless CU-WR \$135 Included with CUX11010-W | 12 Frame Cover 10 ¹ / ₂ " x 18 ¹³ / ₁₆ " Stainless Finish CU-FC \$215 Included with CUX11010-W |

- | | | | |
|---|---|---|---|
| 13 Universal Roller Mat 18 ⁷ / ₁₆ " x 20" Stainless UV-36RM \$175 | 14 Push Button Strainer Kit Chrome 906P-C \$135 Satin Nickel 906P-SN \$160 | 15 Strainer Basket Chrome 906 \$70 Satin Nickel 906SN \$95 | 16 Inox Cream Stainless Steel Polish 903 \$35 |
|---|---|---|---|

Cube Stainless

CUX11023 \$820



SPECIFICATIONS

Interior Dimensions: 23" x 16 1/8" x 9"
 Exterior Dimensions: 24 3/8" x 17 1/4"
 Minimum Cabinet Size: 30"
 Gauge: 18
 Weight: 17 lbs.
 Sound Dampening: Sound Pad & Spray Coat
 Stainless Finish: Pearl
 Corner Radius: 12mm
 Installation: Undermount

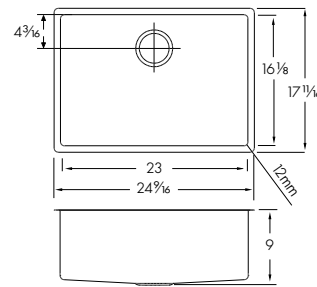

ACCESSORIES

- | | | | | | | | | | | | | | | | |
|---|-------------------------|---|-------------------------|---|-------------------------|---|---------------------|---|---------------------------------|----|---|----|---------------------------------|----|-------------------|
| 1 | Bottom Grid CU23-36S | 6 | Cutting Board CU-40S | 7 | Cutting Board CU-40P | 8 | Colander CUW-70S | 9 | Universal Roller Mat UV-36RM | 10 | Push Button Strainer Kit 906P-C 906P-SN | 11 | Strainer Basket 906 906SN | 12 | Inox Cream 903 |
|---|-------------------------|---|-------------------------|---|-------------------------|---|---------------------|---|---------------------------------|----|---|----|---------------------------------|----|-------------------|

Cube Stainless

CUX11027 \$910



SPECIFICATIONS

Interior Dimensions: 27" x 16 1/8" x 9"
 Exterior Dimensions: 28 1/2" x 17 3/4"
 Minimum Cabinet Size: 33"
 Gauge: 18
 Weight: 19 lbs.
 Sound Dampening: Sound Pad & Spray Coat
 Stainless Finish: Pearl
 Corner Radius: 12mm
 Installation: Undermount

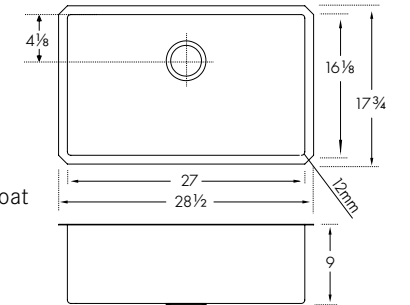

ACCESSORIES

- | | | | | | | | | | | | | | | | |
|---|-------------------------|---|-------------------------|---|-------------------------|---|---------------------|---|---------------------------------|----|---|----|---------------------------------|----|-------------------|
| 4 | Bottom Grid CU27-36S | 6 | Cutting Board CU-40S | 7 | Cutting Board CU-40P | 8 | Colander CUW-70S | 9 | Universal Roller Mat UV-36RM | 10 | Push Button Strainer Kit 906P-C 906P-SN | 11 | Strainer Basket 906 906SN | 12 | Inox Cream 903 |
|---|-------------------------|---|-------------------------|---|-------------------------|---|---------------------|---|---------------------------------|----|---|----|---------------------------------|----|-------------------|

CUX11025 \$850



SPECIFICATIONS

Interior Dimensions: 25" x 16 1/8" x 9"
 Exterior Dimensions: 26 5/8" x 17 3/4"
 Minimum Cabinet Size: 30"
 Gauge: 18
 Weight: 18 lbs.
 Sound Dampening: Sound Pad & Spray Coat
 Stainless Finish: Pearl
 Corner Radius: 12mm
 Installation: Undermount

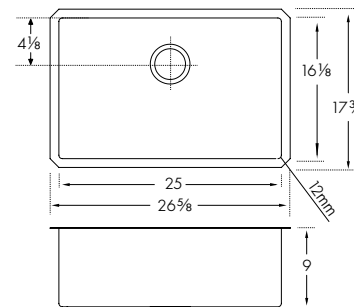

ACCESSORIES

- | | | | | | | | | | | | | | | | |
|---|-------------------------|---|-------------------------|---|-------------------------|---|---------------------|---|---------------------------------|----|---|----|---------------------------------|----|-------------------|
| 2 | Bottom Grid CU25-36S | 6 | Cutting Board CU-40S | 7 | Cutting Board CU-40P | 8 | Colander CUW-70S | 9 | Universal Roller Mat UV-36RM | 10 | Push Button Strainer Kit 906P-C 906P-SN | 11 | Strainer Basket 906 906SN | 12 | Inox Cream 903 |
|---|-------------------------|---|-------------------------|---|-------------------------|---|---------------------|---|---------------------------------|----|---|----|---------------------------------|----|-------------------|

CUX11027-8 \$910



SPECIFICATIONS

Interior Dimensions: 27" x 16 1/8" x 8"
 Exterior Dimensions: 28 1/2" x 17 3/4"
 Minimum Cabinet Size: 33"
 Gauge: 18
 Weight: 19 lbs.
 Sound Dampening: Sound Pad & Spray Coat
 Stainless Finish: Pearl
 Corner Radius: 12mm
 Installation: Undermount

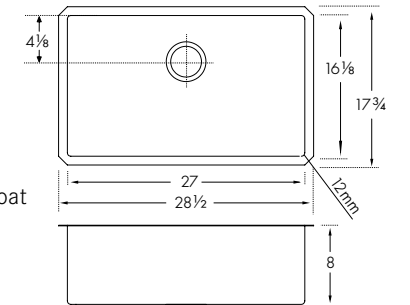

ACCESSORIES

- | | | | | | | | | | | | | | | | |
|---|---------------------------|---|-------------------------|---|-------------------------|---|---------------------|---|---------------------------------|----|---|----|---------------------------------|----|-------------------|
| 5 | Bottom Grid CU27-8-36S | 6 | Cutting Board CU-40S | 7 | Cutting Board CU-40P | 8 | Colander CUW-70S | 9 | Universal Roller Mat UV-36RM | 10 | Push Button Strainer Kit 906P-C 906P-SN | 11 | Strainer Basket 906 906SN | 12 | Inox Cream 903 |
|---|---------------------------|---|-------------------------|---|-------------------------|---|---------------------|---|---------------------------------|----|---|----|---------------------------------|----|-------------------|

CUX11025-8 \$850



SPECIFICATIONS

Interior Dimensions: 25" x 16 1/8" x 8"
 Exterior Dimensions: 26 5/8" x 17 3/4"
 Minimum Cabinet Size: 30"
 Gauge: 18
 Weight: 18 lbs.
 Sound Dampening: Sound Pad & Spray Coat
 Stainless Finish: Pearl
 Corner Radius: 12mm
 Installation: Undermount

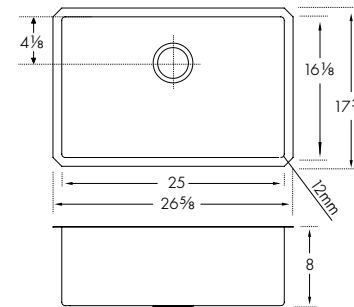

ACCESSORIES

- | | | | | | | | | | | | | | | | |
|---|---------------------------|---|-------------------------|---|-------------------------|---|---------------------|---|---------------------------------|----|---|----|---------------------------------|----|-------------------|
| 3 | Bottom Grid CU25-8-36S | 6 | Cutting Board CU-40S | 7 | Cutting Board CU-40P | 8 | Colander CUW-70S | 9 | Universal Roller Mat UV-36RM | 10 | Push Button Strainer Kit 906P-C 906P-SN | 11 | Strainer Basket 906 906SN | 12 | Inox Cream 903 |
|---|---------------------------|---|-------------------------|---|-------------------------|---|---------------------|---|---------------------------------|----|---|----|---------------------------------|----|-------------------|

ACCESSORIES

- | | | | | | |
|---|--|--|--|--|--|
| | | | | | |
| 1 | 2 | 3 | 4 | 5 | 6 |
| Bottom Grid 22 1/2" x 15 3/8" Stainless CU23-36S \$150 | Bottom Grid 24 7/32" x 15 3/8" Stainless CU25-36S \$165 | Bottom Grid 23 3/8" x 14 3/4" Stainless CU25-8-36S \$160 | Bottom Grid 26 3/16" x 15 3/8" Stainless CU27-36S \$165 | Bottom Grid 25 9/16" x 14 3/4" Stainless CU27-8-36S \$160 | Cutting Board 7 1/16" x 16 7/8" Walnut CU-40S \$160 |
| | | | | | |
| 7 | 8 | 9 | 10 | 11 | 12 |
| Cutting Board 7 1/16" x 16 7/8" Black Plastic CU-40P \$105 | Colander 6 3/16" x 17 3/8" x 2 1/8" Stainless CUW-70S \$210 | Universal Roller Mat 18 7/16" x 20" Stainless UV-36RM \$175 | Push Button Strainer Kit Chrome 906P-C \$135 Satin Nickel 906P-SN \$160 | Strainer Basket Chrome 906 \$70 Satin Nickel 906SN \$95 | Inox Cream Stainless Steel Polish 903 \$35 |

CUX11030

\$1,015



SPECIFICATIONS

Interior Dimensions: 30" x 16 1/8" x 9"
 Exterior Dimensions: 31 1/2" x 17 3/4"
 Minimum Cabinet Size: 36"
 Gauge: 18
 Weight: 21 lbs.
 Sound Dampening: Sound Pad & Spray Coat
 Stainless Finish: Pearl
 Corner Radius: 12mm
 Installation: Undermount

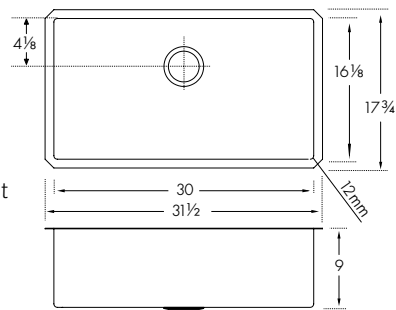

ACCESSORIES

- 6 Bottom Grid CU30-36S
- 8 Cutting Board CU-40S
- 9 Cutting Board CU-40P
- 10 Colander CUW-70S
- 11 Universal Roller Mat UV-36RM
- 12 Push Button Strainer Kit 906P-C 906P-SN
- 13 Strainer Basket 906 906SN
- 14 Inox Cream 903

CUX11030-8

\$1,015



SPECIFICATIONS

Interior Dimensions: 30" x 16 1/8" x 8"
 Exterior Dimensions: 31 1/2" x 17 3/4"
 Minimum Cabinet Size: 36"
 Gauge: 18
 Weight: 21 lbs.
 Sound Dampening: Sound Pad & Spray Coat
 Stainless Finish: Pearl
 Corner Radius: 12mm
 Installation: Undermount

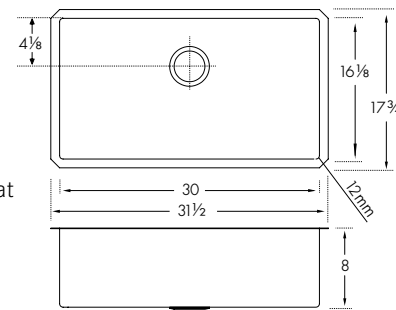

ACCESSORIES

- 7 Bottom Grid CU30-8-36S
- 8 Cutting Board CU-40S
- 9 Cutting Board CU-40P
- 10 Colander CUW-70S
- 11 Universal Roller Mat UV-36RM
- 12 Push Button Strainer Kit 906P-C 906P-SN
- 13 Strainer Basket 906 906SN
- 14 Inox Cream 903

NEW CUX16024

\$910



SPECIFICATIONS

Interior Dimensions: 23 7/8" x 16 1/8" x 9"
 Exterior Dimensions: 25 1/16" x 17 1/16"
 Minimum Cabinet Size: 30"
 Gauge: 18
 Weight: 22.6 lbs.
 Sound Dampening: Sound Pad & Spray Coat
 Stainless Finish: Pearl
 Corner Radius: 12mm
 Installation: Undermount

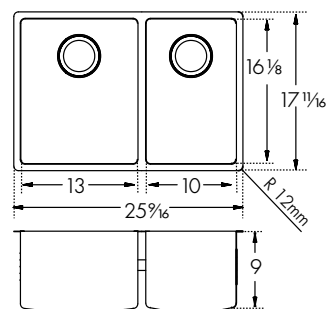

ACCESSORIES

- 1 Bottom Grid CU10-36S
- 3 Bottom Grid CU13-36S
- 8 Cutting Board CU-40S
- 9 Cutting Board CU-40P
- 10 Colander CUW-70S
- 11 Universal Roller Mat UV-36RM
- 12 Push Button Strainer Kit 906P-C 906P-SN
- 13 Strainer Basket 906 906SN
- 14 Inox Cream 903

CUX160

\$1,125



SPECIFICATIONS

Interior Dimensions: 30" x 16 1/8" x 9"
 Exterior Dimensions: 31 1/2" x 17 3/4"
 Minimum Cabinet Size: 36"
 Gauge: 18
 Weight: 24 lbs.
 Sound Dampening: Sound Pad & Spray Coat
 Stainless Finish: Pearl
 Corner Radius: 12mm
 Installation: Undermount

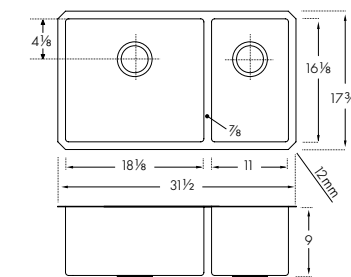

ACCESSORIES

- 2 Bottom Grid CU11-36S
- 5 Bottom Grid CU18-36S
- 8 Cutting Board CU-40S
- 9 Cutting Board CU-40P
- 10 Colander CUW-70S
- 11 Universal Roller Mat UV-36RM
- 12 Push Button Strainer Kit 906P-C 906P-SN
- 13 Strainer Basket 906 906SN
- 14 Inox Cream 903

CUX120

\$1,125



SPECIFICATIONS

Interior Dimensions: 30" x 16 1/8" x 9"
 Exterior Dimensions: 31 1/2" x 17 3/4"
 Minimum Cabinet Size: 36"
 Gauge: 18
 Weight: 24 lbs.
 Sound Dampening: Sound Pad & Spray Coat
 Stainless Finish: Pearl
 Corner Radius: 12mm
 Installation: Undermount

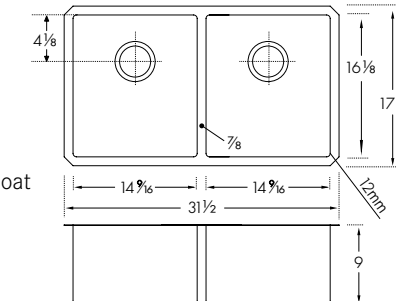

ACCESSORIES

- 4 Bottom Grid CU15-36S
- 8 Cutting Board CU-40S
- 9 Cutting Board CU-40P
- 10 Colander CUW-70S
- 11 Universal Roller Mat UV-36RM
- 12 Push Button Strainer Kit 906P-C 906P-SN
- 13 Strainer Basket 906 906SN
- 14 Inox Cream 903

ACCESSORIES

- 1 Bottom Grid 23 11/32" x 15 1/2" Stainless CU10-36S \$115
- 2 Bottom Grid 10 1/4" x 15 3/8" Stainless CU11-36S \$125
- 3 Bottom Grid 11 15/16" x 15 1/2" Stainless CU13-36S \$120
- 4 Bottom Grid 13 3/4" x 15 3/8" Stainless CU15-36S \$135
- 5 Bottom Grid 17 7/16" x 15 3/8" Stainless CU18-36S \$150
- 6 Bottom Grid 29 1/4" x 15 3/8" Stainless CU30-36S \$175
- 7 Bottom Grid 28 19/32" x 14 3/4" Stainless CU30-8-36S \$170
- 8 Cutting Board 7 1/16" x 16 7/8" Walnut CU-40S \$160
- 9 Cutting Board 7 7/16" x 16 7/8" Black Plastic CU-40P \$105
- 10 Colander 6 3/16" x 17 3/16" x 2 1/8" Stainless CUW-70S \$210
- 11 Universal Roller Mat 18 7/16" x 20" Stainless UV-36RM \$175
- 12 Push Button Strainer Kit Chrome 906P-C \$135
Satin Nickel 906P-SN \$160
- 13 Strainer Basket Chrome 906 \$70
Satin Nickel 906SN \$95
- 14 Inox Cream Stainless Steel Polish 903 \$35

NEW CUX16032 \$1,170



SPECIFICATIONS

Interior Dimensions: 30⁷/₈" x 16¹/₈" x 9"
 Exterior Dimensions: 32⁷/₁₆" x 17¹¹/₁₆"
 Minimum Cabinet Size: 36"
 Gauge: 18
 Weight: 26.8 lbs.
 Sound Dampening: Sound Pad & Spray Coat
 Stainless Finish: Pearl
 Corner Radius: 12mm
 Installation: Undermount

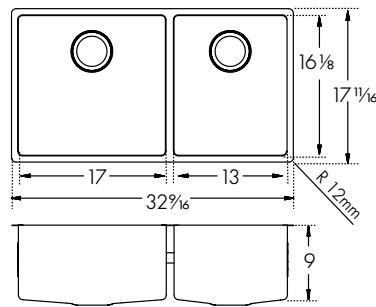

ACCESSORIES

| | | | | | | | | |
|------------------------------------|------------------------------------|------------------------------------|------------------------------------|--------------------------------|--|--|---|-------------------------------|
| 1 Bottom Grid CU13-36S | 2 Bottom Grid CU17-36S | 5 Cutting Board CU-40S | 6 Cutting Board CU-40P | 7 Colander CUW-70S | 8 Universal Roller Mat UV-36RM | 9 Push Button Strainer Kit 906P-C 906P-SN | 10 Strainer Basket 906 906SN | 11 Inox Cream 903 |
|------------------------------------|------------------------------------|------------------------------------|------------------------------------|--------------------------------|--|--|---|-------------------------------|

CUX11021-ADA \$790



SPECIFICATIONS

Interior Dimensions: 21¹/₄" x 16¹/₈" x 5"
 Exterior Dimensions: 22³/₄" x 17³/₄"
 Minimum Cabinet Size: 27"
 Gauge: 18
 Weight: 16 lbs.
 Sound Dampening: Sound Pad
 Stainless Finish: Pearl
 Corner Radius: 12mm
 Installation: Undermount
 ADA Compliant

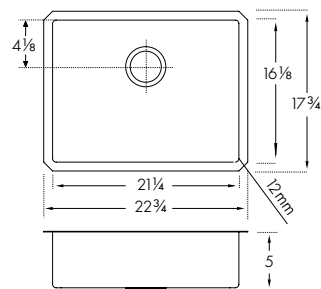

ACCESSORIES

| | | | | | | | |
|------------------------------------|------------------------------------|------------------------------------|--------------------------------|--|--|---|-------------------------------|
| 3 Bottom Grid CU21-36S | 5 Cutting Board CU-40S | 6 Cutting Board CU-40P | 7 Colander CUW-70S | 8 Universal Roller Mat UV-36RM | 9 Push Button Strainer Kit 906P-C 906P-SN | 10 Strainer Basket 906 906SN | 11 Inox Cream 903 |
|------------------------------------|------------------------------------|------------------------------------|--------------------------------|--|--|---|-------------------------------|

CUX11027-ADA \$910



SPECIFICATIONS

Interior Dimensions: 27" x 16¹/₈" x 5"
 Exterior Dimensions: 28¹/₂" x 17³/₄"
 Minimum Cabinet Size: 33"
 Gauge: 18
 Weight: 19 lbs.
 Sound Dampening: Sound Pad
 Stainless Finish: Pearl
 Corner Radius: 12mm
 Installation: Undermount
 ADA Compliant

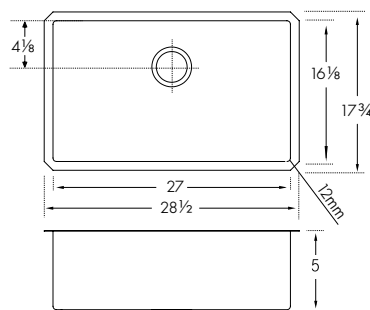

ACCESSORIES

| | | | | | | | |
|------------------------------------|------------------------------------|------------------------------------|--------------------------------|--|--|---|-------------------------------|
| 4 Bottom Grid CU27-36S | 5 Cutting Board CU-40S | 6 Cutting Board CU-40P | 7 Colander CUW-70S | 8 Universal Roller Mat UV-36RM | 9 Push Button Strainer Kit 906P-C 906P-SN | 10 Strainer Basket 906 906SN | 11 Inox Cream 903 |
|------------------------------------|------------------------------------|------------------------------------|--------------------------------|--|--|---|-------------------------------|

ACCESSORIES

| | | | | | |
|---|--|--|--|--|---|
| 1 Bottom Grid 11 ¹⁵ / ₁₆ " x 15 ¹ / ₂ " Stainless CU13-36S \$120 | 2 Bottom Grid 16 ³ / ₃₂ " x 15 ¹ / ₂ " Stainless CU17-36S \$135 | 3 Bottom Grid 20 ³ / ₁₆ " x 15 ³ / ₈ " Stainless CU21-36S \$150 | 4 Bottom Grid 26 ³ / ₁₆ " x 15 ³ / ₈ " Stainless CU27-36S \$165 | 5 Cutting Board 7 ¹ / ₁₆ " x 16 ⁷ / ₈ " Walnut CU-40S \$160 | 6 Cutting Board 7 ¹ / ₁₆ " x 16 ⁷ / ₈ " Black Plastic CU-40P \$105 |
| 7 Colander 6 ³ / ₁₆ " x 17 ³ / ₈ " x 2 ¹ / ₈ " Stainless CUW-70S \$210 | 8 Universal Roller Mat 18 ⁷ / ₁₆ " x 20" Stainless UV-36RM \$175 | 9 Push Button Strainer Kit Chrome 906P-C \$135 Satin Nickel 906P-SN \$160 | 10 Strainer Basket Chrome 906 \$70 Satin Nickel 906SN \$95 | 11 Inox Cream Stainless Steel Polish 903 \$35 | |

PERFECT TOGETHER

Cube Faucets

For the complete CUBE Faucet Collection see pages 238-239.



FFPD3350



FF3352



FFT3350



FFP3350



Grande

While providing the functionality of a **large surface** and the convenience of **wide corners**, the Grande series will meet your everyday kitchen needs. These design elements provide a unique collaboration of utility and **ease of cleaning**.



Pictured: GDX11023 sink with FF4700 faucet and SD-500 soap dispenser

Grande

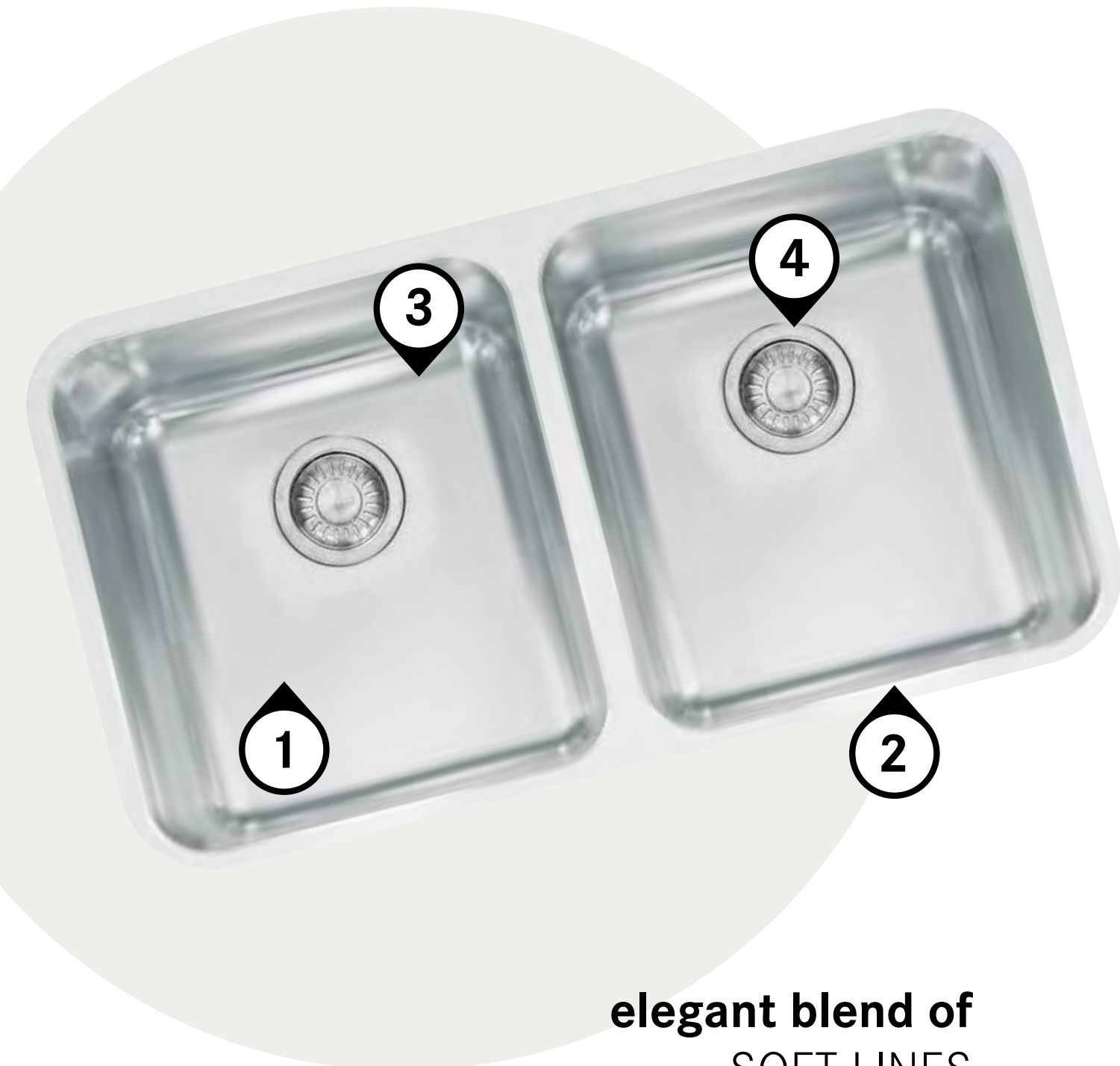

**elegant blend of
SOFT LINES**

1

Commercial Grade Stainless

18 gauge stainless steel with exceptional resistance to staining.



2

Sound Dampening System

Sound dampening pads and spray coat reduce excess noise from running water and disposal vibration.



3

Deep Bowls

Maximizing sink capacity with deep bowls to give the sink space needed to complete tasks with ease.



4

Rear Drain

Maximizes the usable bottom surface of the bowl while also creating extra cabinet space beneath the sink.



GDX11012 \$595



SPECIFICATIONS

Interior Dimensions: 12" x 17" x 8"
 Exterior Dimensions: 13 3/4" x 18 3/4"
 Minimum Cabinet Size: 18"
 Gauge: 18
 Weight: 12 lbs.
 Sound Dampening: Sound Pad & Spray Coat
 Stainless Finish: Silk
 Corner Radius: 50mm
 Installation: Undermount

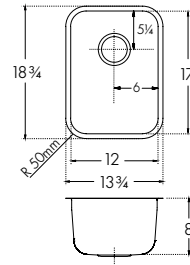

ACCESSORIES

- | | | | | |
|---|---|--|--|--------------------------------------|
| 1 Bottom Grid GD12-36S | 8 Universal Roller Mat UV-36RM | 9 Pop-Up Strainer 900P 900P-SN27 | 10 Strainer Basket 906 906SN | 11 Inox Cream 903 |
|---|---|--|--|--------------------------------------|

GDX11015 \$640



SPECIFICATIONS

Interior Dimensions: 15" x 17" x 9"
 Exterior Dimensions: 16 3/4" x 18 3/4"
 Minimum Cabinet Size: 21"
 Gauge: 18
 Weight: 15 lbs.
 Sound Dampening: Sound Pad & Spray Coat
 Stainless Finish: Silk
 Corner Radius: 50mm
 Installation: Undermount

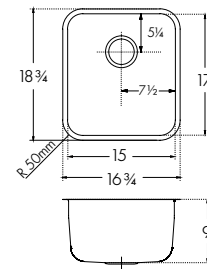

ACCESSORIES

- | | | | | |
|---|---|--|--|--------------------------------------|
| 2 Bottom Grid GD15-36S | 8 Universal Roller Mat UV-36RM | 9 Pop-Up Strainer 900P 900P-SN27 | 10 Strainer Basket 906 906SN | 11 Inox Cream 903 |
|---|---|--|--|--------------------------------------|

GDX11018 \$740



SPECIFICATIONS

Interior Dimensions: 18" x 19 3/4" x 9"
 Exterior Dimensions: 19 3/4" x 21 1/2"
 Minimum Cabinet Size: 24"
 Gauge: 18
 Weight: 17 lbs.
 Sound Dampening: Sound Pad & Spray Coat
 Stainless Finish: Silk
 Corner Radius: 50mm
 Installation: Undermount

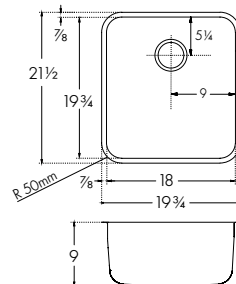

ACCESSORIES

- | | | | |
|---|--|--|--------------------------------------|
| 3 Bottom Grid GD18-36S | 9 Pop-Up Strainer 900P 900P-SN27 | 10 Strainer Basket 906 906SN | 11 Inox Cream 903 |
|---|--|--|--------------------------------------|

GDX11023 \$820



SPECIFICATIONS

Interior Dimensions: 23" x 17" x 9"
 Exterior Dimensions: 24 3/4" x 18 3/4"
 Minimum Cabinet Size: 30"
 Gauge: 18
 Weight: 21 lbs.
 Sound Dampening: Sound Pad & Spray Coat
 Stainless Finish: Silk
 Corner Radius: 50mm
 Installation: Undermount

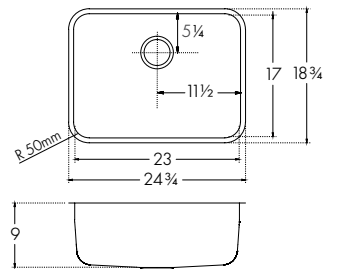

ACCESSORIES

- | | | | | | |
|---|---|---|--|--|--------------------------------------|
| 4 Bottom Grid GD23-36S | 6 Cutting Board GD-40S | 8 Universal Roller Mat UV-36RM | 9 Pop-Up Strainer 900P 900P-SN27 | 10 Strainer Basket 906 906SN | 11 Inox Cream 903 |
|---|---|---|--|--|--------------------------------------|

GDX11028 \$870



SPECIFICATIONS

Interior Dimensions: 28" x 17" x 9"
 Exterior Dimensions: 30 1/8" x 19 1/8"
 Minimum Cabinet Size: 36"
 Gauge: 18
 Weight: 25 lbs.
 Sound Dampening: Sound Pad & Spray Coat
 Stainless Finish: Silk
 Corner Radius: 70mm
 Installation: Undermount

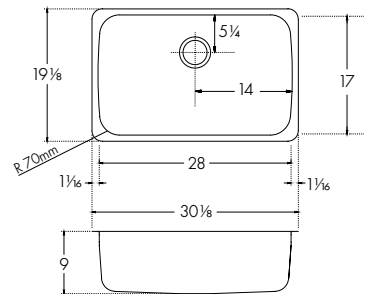

ACCESSORIES

- | | | | | | |
|---|---|---|--|--|--------------------------------------|
| 5 Bottom Grid GD28-36S | 7 Cutting Board GD28-40S | 8 Universal Roller Mat UV-36RM | 9 Pop-Up Strainer 900P 900P-SN27 | 10 Strainer Basket 906 906SN | 11 Inox Cream 903 |
|---|---|---|--|--|--------------------------------------|

ACCESSORIES

- | | | | | | |
|---|--|--|--|---|--|
| 1 Bottom Grid 10 1/2" x 15 1/2" Stainless GD12-36S \$135 | 2 Bottom Grid 13 5/8" x 15 1/2" Stainless GD15-36S \$150 | 3 Bottom Grid 16 1/2" x 18 1/4" Stainless GD18-36S \$165 | 4 Bottom Grid 21 1/2" x 15 1/2" Stainless GD23-36S \$175 | 5 Bottom Grid 25 7/8" x 15 5/8" Stainless GD28-36S \$210 | 6 Cutting Board 18 3/8" x 14 3/4" Solid Wood GD-40S \$270 |
| 7 Cutting Board 18 7/16" x 14 3/4" Solid Wood GD28-40S \$270 | 8 Universal Roller Mat 18 7/16" x 20" Stainless UV-36RM \$175 | 9 Pop-Up Strainer Chrome 900P \$125 Satin Nickel 900P-SN27 \$150 | 10 Strainer Basket Chrome 906 \$70 Satin Nickel 906SN \$95 | 11 Inox Cream Stainless Steel Polish 903 \$35 | |

GDX11031 \$940



SPECIFICATIONS

Interior Dimensions: 31" x 17" x 9"
 Exterior Dimensions: 32¾" x 18¾"
 Minimum Cabinet Size: 36"
 Gauge: 18
 Weight: 28 lbs.
 Sound Dampening: Sound Pad & Spray Coat
 Stainless Finish: Silk
 Corner Radius: 50mm
 Installation: Undermount

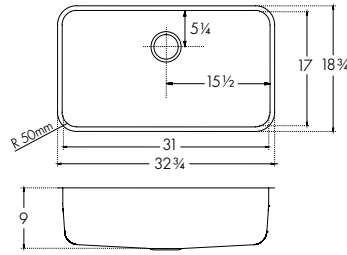

ACCESSORIES

| | | | | | |
|----------------------------------|----------------------------------|--|---|--|-----------------------------|
| 1 Bottom Grid GD31-36S | 6 Cutting Board GD-40S | 7 Universal Roller Mat UV-36RM | 8 Pop-Up Strainer 900P 900P-SN27 | 9 Strainer Basket 906 906SN | 10 Inox Cream 903 |
|----------------------------------|----------------------------------|--|---|--|-----------------------------|

GDX16028RH \$1,045



SPECIFICATIONS

Interior Dimensions: 28⅞" x 17" x 9" & 8"
 Exterior Dimensions: 29⅞" x 18¾"
 Minimum Cabinet Size: 36"
 Gauge: 18
 Weight: 20 lbs.
 Sound Dampening: Sound Pad & Spray Coat
 Stainless Finish: Silk
 Corner Radius: 51mm
 Installation: Undermount

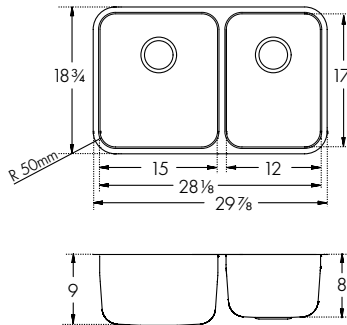

ACCESSORIES

| | | | | | | |
|----------------------------------|----------------------------------|----------------------------------|--|---|--|-----------------------------|
| 2 Bottom Grid GD12-36S | 4 Bottom Grid GD15-36S | 6 Cutting Board GD-40S | 7 Universal Roller Mat UV-36RM | 8 Pop-Up Strainer 900P 900P-SN27 | 9 Strainer Basket 906 906SN | 10 Inox Cream 903 |
|----------------------------------|----------------------------------|----------------------------------|--|---|--|-----------------------------|

GDX12031 \$1,075



SPECIFICATIONS

Interior Dimensions: 31⅞" x 17" x 9"
 Exterior Dimensions: 32⅞" x 18¾"
 Minimum Cabinet Size: 36"
 Gauge: 18
 Weight: 29 lbs.
 Sound Dampening: Sound Pad & Spray Coat
 Stainless Finish: Silk
 Corner Radius: 50mm
 Installation: Undermount

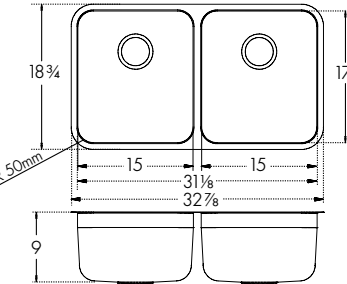

ACCESSORIES

| | | | | | |
|----------------------------------|----------------------------------|--|---|--|-----------------------------|
| 4 Bottom Grid GD15-36S | 6 Cutting Board GD-40S | 7 Universal Roller Mat UV-36RM | 8 Pop-Up Strainer 900P 900P-SN27 | 9 Strainer Basket 906 906SN | 10 Inox Cream 903 |
|----------------------------------|----------------------------------|--|---|--|-----------------------------|

GDX16031RH \$1,095



SPECIFICATIONS

Interior Dimensions: 31⅞" x 17" x 9" x 8"
 Exterior Dimensions: 32⅞" x 18¾"
 Minimum Cabinet Size: 36"
 Gauge: 18
 Weight: 27 lbs.
 Sound Dampening: Sound Pad & Spray Coat
 Stainless Finish: Silk
 Corner Radius: 50mm
 Installation: Undermount

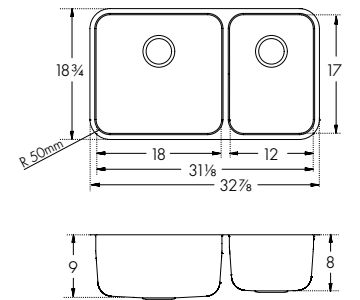

ACCESSORIES

| | | | | | | |
|----------------------------------|----------------------------------|----------------------------------|--|---|--|-----------------------------|
| 3 Bottom Grid NC12-36S | 5 Bottom Grid NC18-36S | 6 Cutting Board GD-40S | 7 Universal Roller Mat UV-36RM | 8 Pop-Up Strainer 900P 900P-SN27 | 9 Strainer Basket 906 906SN | 10 Inox Cream 903 |
|----------------------------------|----------------------------------|----------------------------------|--|---|--|-----------------------------|

ACCESSORIES

| | | | | |
|---|---|---|--|--|
| 1 Bottom Grid 29⅞" x 15½" Stainless GD31-36S \$220 | 2 Bottom Grid 10½" x 15½" Stainless GD12-36S \$135 | 3 Bottom Grid 10¾" x 14⅝" Stainless NC12-36S \$80 | 4 Bottom Grid 13⅝" x 15½" Stainless GD15-36S \$130 | 5 Bottom Grid 15⅝" x 14⅝" Stainless NC18-36S \$115 |
| 6 Cutting Board 18⅝" x 14¾" Solid Wood GD-40S \$270 | 7 Universal Roller Mat 18⅞" x 20" Stainless UV-36RM \$175 | 8 Pop-Up Strainer Chrome 900P \$125 Satin Nickel 900P-SN27 \$150 | 9 Strainer Basket Chrome 906 \$70 Satin Nickel 906SN \$95 | 10 Inox Cream Stainless Steel Polish 903 \$35 |

Rotondo

The Rotondo offers the option of **topmount or undermount** installation along with a **smaller size** that works well in the kitchen, bar or laundry. Its attractive **round design** perks up even the most utilitarian space.



Pictured: RBX-110 sink with FFB3100 faucet

Rotondo



1

Dual Mount Installation

Provides versatility, installing as a fashionable undermount with an edgeless finish or an easy drop-in with rim extending over the countertop surface.



2

Easy to Clean

Round smooth edges are easy to clean and maintain, while the stainless steel keeps the sink stain free.



RBX-110 \$590



SPECIFICATIONS

Interior Dimensions: 14 $\frac{3}{4}$ " x 6 $\frac{9}{16}$ "
 Exterior Dimensions: 17 $\frac{1}{8}$ " x 6 $\frac{9}{16}$ "
 Minimum Cabinet Size: 21" (undermount)
 18" (topmount)

Gauge: 20
 Weight: 5 lbs.
 Sound Dampening: Sound Pad
 Stainless Finish: Silk
 Installation: Undermount
 with 1/2" Reveal or Topmount

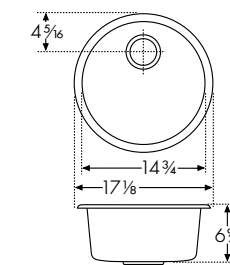





May be used as a topmount (has polished rim).
 May be undermounted (requires EL-Clips).
 Use interior dimensions as cutout guide.

ACCESSORIES

| | | | | | | | |
|---|--|---|---|---|--|---|--------------------------|
| 1 | Universal Roller Mat UV-36RM | 2 | Pop-Up Strainer 900P 900P-SN27 | 3 | Strainer Basket 906 906SN | 4 | Inox Cream 903 |
|---|--|---|---|---|--|---|--------------------------|

ACCESSORIES

| | | | |
|--|---|--|---|
|  |  |  |  |
| 1 Universal Roller Mat 18 $\frac{7}{16}$ " x 20" Stainless UV-36RM \$175 | 2 Pop-Up Strainer Chrome 900P \$125 Satin Nickel 900P-SN27 \$150 | 3 Strainer Basket Chrome 906 \$70 Satin Nickel 906SN \$95 | 4 Inox Cream Stainless Steel Polish 903 \$35 |



The Outdoor Series

Whether your preference is for casual backyard barbecues or elaborate summertime soirées, your outdoor kitchen workspace requires a sink that stands up to the elements and enhances your entertaining style. The Outdoor Series is designed with the **attention to detail and quality** that is the hallmark of Franke products.

The simple styling of this undermount design features angled interior lines to promote better draining and help keep your sink clean. Pair it with the weather-resistant Outdoor Series faucet, also made of **18-gauge T316 stainless**, for an outdoor kitchen that will **retain its beauty and integrity for years**.

Note: It is recommended to cover sink in the winter to prevent ice build up. Ice may damage the bowl by expansion.

Pictured: ODX110-2312-316 sink with FF3352 faucet

The Outdoor Series

1
Weather Resistant
 Manufactured with high-grade, 18-gauge T316 stainless steel – one of the most corrosion resistant grades available – Outdoor Series sinks and faucets can handle rain, cold, snow and heavy use.



2
Large Capacity Bowls
 Deep basin provides maximum flexibility. Easily accommodates nearly any pot or pan, and minimizes splashing.



3
Precision Drain
 Designed with sloped, elegant lines on the bottom of the bowl to allow water to drain from sink.



4
Sound Dampening System
 Sound dampening pads and spray coat reduce excess noise from running water and disposal vibration.



a breath of
 FRESH AIR

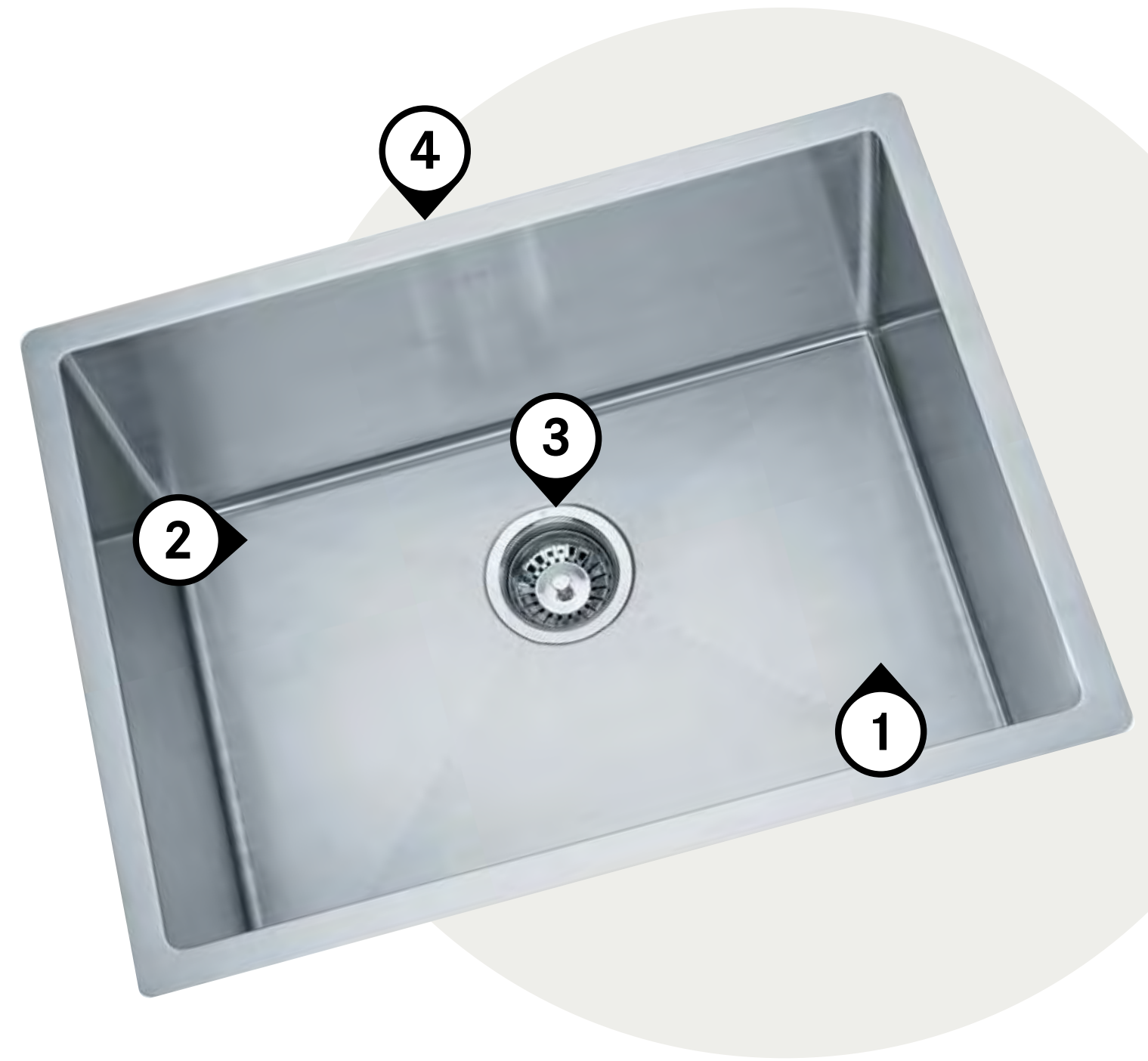

ODX110-2310-316 \$910

Suitable for outdoor use



T316 strainer basket included

SPECIFICATIONS

Interior Dimensions: 23" x 17" x 10"
 Exterior Dimensions: 25" x 19"
 Minimum Cabinet Size: 30"
 Gauge: 18 T316 Stainless Steel
 Weight: 31 lbs.
 Sound Dampening: Sound Pad and Spray Coat
 Finish: Pearl
 Corner Radius: 10mm
 Installation: Undermount with 1/2" Reveal

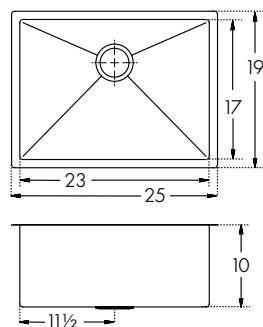

ACCESSORIES

- | | |
|---|---|
| <p>1 Bottom Grid PS23-36S Included</p> | <p>2 Strainer Basket 906 906SN</p> |
|---|---|

ODX110-2312-316 \$960

Suitable for outdoor use



T316 strainer basket included

SPECIFICATIONS

Interior Dimensions: 23" x 17" x 12"
 Exterior Dimensions: 25" x 19"
 Minimum Cabinet Size: 30"
 Gauge: 18 T316 Stainless Steel
 Weight: 31 lbs.
 Sound Dampening: Sound Pad and Spray Coat
 Finish: Pearl
 Corner Radius: 10mm
 Installation: Undermount with 1/2" Reveal

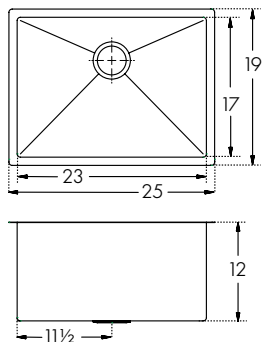

ACCESSORIES

- | | |
|---|---|
| <p>1 Bottom Grid PS23-36S Included</p> | <p>2 Strainer Basket 906 906SN</p> |
|---|---|

ACCESSORIES



- 1 | Bottom Grid**
22 1/4" x 16 1/4"
Stainless
PS23-36S
\$245
Included



- 2 | Strainer Basket**
Chrome
906
\$70
Satin Nickel
906SN
\$95

Note: All accessories sold separately unless otherwise indicated. Design of custom accessories subject to change without notice. It is absolutely critical that you have the sink and any custom sink accessories on site prior to any cut or modification to the countertop. Franke will not be responsible for any errors in countertop preparation and sink installation.

PERFECT TOGETHER

Outdoor Faucet

FF3352

FF3352 Stainless Steel **\$750**

Suitable for outdoor use



FEATURES AND BENEFITS

1-Hole Pull-Down
 Flow Rate: 1.75 gpm
 Spray Function: Toggle
 Spray Type: Spray & Stream
 Spout Swivel Range: 360°
 Cartridge: 35mm Ceramic
 Countertop Hole Diameter: 1 3/8"
 Weight: 10 lbs.
 316 Stainless Steel
 ADA Compliant

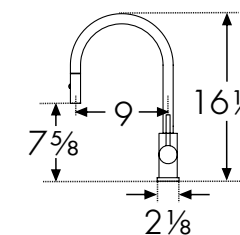

NEW FF3452SS

FF3452SS Stainless Steel **\$850**

Suitable for outdoor use



FEATURES AND BENEFITS

1-Hole Pull-Down
 Flow Rate: 1.75 gpm
 Spray Function: Toggle
 Spray Type: Spray & Stream
 Spout Swivel Range: 360°
 Cartridge: 35mm Ceramic
 Countertop Hole Diameter: 1 3/8"
 Weight: 8 lbs.
 316 Stainless Steel
 ADA Compliant

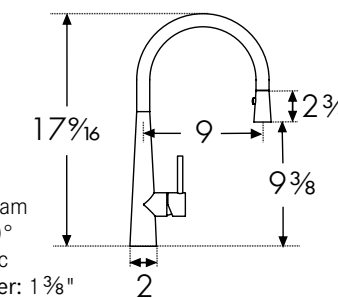

Note: All accessories sold separately unless otherwise indicated. Design of custom accessories subject to change without notice. It is absolutely critical that you have the sink and any custom sink accessories on site prior to any cut or modification to the countertop. Franke will not be responsible for any errors in countertop preparation and sink installation.



Fireclay Sinks

| | |
|-------------|---------|
| Farm House | 108-113 |
| Manor House | 114-119 |
| Orca | 120-123 |
| Prestige | 124-127 |
| Cisterna | 128-133 |



Note: Color may vary between series.

Wonderfully Elegant Fireclay

HOW YOUR FIRECLAY SINK IS MADE

Liquid ceramic consisting of quartz, china clay and kaolin is injected into a mold under high pressure. Prior to drying, surface imperfections are smoothed with soft sponges and a level surface is created with water. The final drying process involves 20 hours in a tunnel kiln at 2200° F. At every stage, each sink is subjected to stringent quality checks performed by experts to make it wonderful.

A LIFETIME OF SERVICE

Fireclay is entirely natural, very stylish and amazingly practical. We apply a dirt-repellent finishing polish, which means that any mess, tea or red wine stains can simply be wiped with a little soapy water.

SILKY SMOOTH GOOD LOOKS

Fireclay sinks combine beautifully with a variety of work surfaces, such as wood, glass and granite. It's a durable choice that stands up to heat, staining and impact with ease.

VILLEROY & BOCH

Many handcrafted Franke Fireclay sinks are designed in partnership with Villeroy & Boch, a world-renowned premium porcelain and ceramic producer since 1748. Together, Franke and Villeroy & Boch create distinctive designs that enhance your personal kitchen style.



Farm House

Franke's **apron front** Farm House sinks are made of attractive fireclay for a **smooth, polished finish** that's both durable and **easy to clean**. For flexibility, we offer three sizes that let you install a **traditional flat apron front** design.

Note: Color may vary between series.



Pictured: FHK710-33WH sink with FF7000A faucet

Farm House

Farm House
Fireclay

Farm House
Fireclay



stunningly
SPACIOUS

1

Easy to Clean

A dirt-repellent finishing polish keeps stains like tea and red wine at bay, allowing them to be wiped away with only soap and water.



2

9" Deep Bowls

Maximizing sink capacity, Farm House offers deep bowls to give you the space you need to complete tasks with ease.



3

Rear Drain*

The rear drain maximizes the usable bottom surface of the bowl while also creating extra cabinet space beneath the sink.



4

Apron Front Design

The apron front design enables the user to stand directly in front of the basin, with no cabinets or countertop in between, making it more comfortable for prepping food and cleaning up.



*Select models

FHK710-30WH ■ White

\$1,165



SPECIFICATIONS

Interior Dimensions: 28 1/8" x 18 1/4" x 9 3/16"
 Exterior Dimensions: 30 1/8" x 20" x 10 1/8"
 Minimum Cabinet Size: 33"
 Weight: 103 lbs.
 Corner Radius: 19mm
 Installation: Undermount
 Apron Front

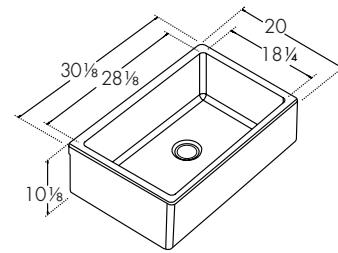

ACCESSORIES

- | | | |
|----------------------------------|----------------------------------|--|
| 1 Bottom Grid FK30-36S | 4 Cutting Board OA-40S | 5 Strainer Basket 906 906SN |
|----------------------------------|----------------------------------|--|

Note: Dimensions may vary by 2% (plus or minus), due to material attributes and firing process. See website for Fireclay Repair Kits. Pop-Up strainer not compatible. **Special installation required - see website.** Finished on front and sides only.

FHK710-33WH ■ White

\$1,490



SPECIFICATIONS

Interior Dimensions: 31 7/16" x 18 1/4" x 9 3/16"
 Exterior Dimensions: 33" x 20" x 10 1/8"
 Minimum Cabinet Size: 33"
 Weight: 110 lbs.
 Corner Radius: 19mm
 Installation: Undermount
 Apron Front

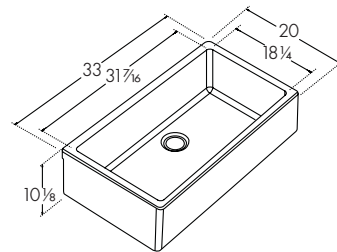

ACCESSORIES

- | | | |
|----------------------------------|----------------------------------|--|
| 2 Bottom Grid FK33-36S | 4 Cutting Board OA-40S | 5 Strainer Basket 906 906SN |
|----------------------------------|----------------------------------|--|

Note: Dimensions may vary by 2% (plus or minus), due to material attributes and firing process. See website for Fireclay Repair Kits. Pop-Up strainer not compatible. **Special installation required - see website.** Finished on front and sides only.

FHK710-36WH ■ White

\$1,620



SPECIFICATIONS

Interior Dimensions: 34 7/16" x 18 1/4" x 9 3/16"
 Exterior Dimensions: 36" x 20" x 10 1/8"
 Minimum Cabinet Size: 36"
 Weight: 117 lbs.
 Corner Radius: 19mm
 Installation: Undermount
 Apron Front

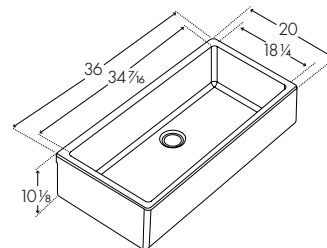

ACCESSORIES

- | | | |
|----------------------------------|----------------------------------|--|
| 3 Bottom Grid FK36-36S | 4 Cutting Board OA-40S | 5 Strainer Basket 906 906SN |
|----------------------------------|----------------------------------|--|

Note: Dimensions may vary by 2% (plus or minus), due to material attributes and firing process. See website for Fireclay Repair Kits. Pop-Up strainer not compatible. **Special installation required - see website.** Finished on front and sides only.

ACCESSORIES



1 Bottom Grid
27 1/8" x 16 7/8"
Stainless
FK30-36S
\$270



2 Bottom Grid
29 13/16" x 16 7/8"
Stainless
FK33-36S
\$300



3 Bottom Grid
32 1/16" x 16 7/8"
Stainless
FK36-36S
\$315



4 Cutting Board
14 1/2" x 21 7/8"
Solid Wood
OA-40S
\$385



5 Strainer Basket
Chrome
906
\$70
Satin Nickel
906SN
\$95

PERFECT TOGETHER

Farm House Faucets & Dispenser

For the complete FARM HOUSE Faucet Collection see pages 192-195.
 For dispenser details see page 257.



FF6000A



FFPD400



PF7000A



DW6100C



DW12000



SD6000



Pictured: MHK720-35WH sink with FF7000A faucet, LB12200 filtration faucet, SD6000 soap dispenser and WD3428C air switch

Manor House

Villeroy & Boch brings centuries of excellence to the handcrafted beauty of Manor House **apron front** sinks. **Scratch-resistant** and **hygienic** fireclay offers the qualities most desired in today's kitchens.



Note: Color may vary between series.

Manor House

1

Apron Front Design

The apron front design enables the user to stand directly in front of the basin, with no cabinets or countertop in between, making it more comfortable for prepping food and cleaning up.



2

Stain Resistant

We apply a dirt-repellent finishing polish, which means that any mess, tea or red wine stains can simply be wiped away with a little soapy water.



3

CeramicPlus

The CeramicPlus coating causes liquids to bead upon making contact with the sink's surface, repelling dirt, lime-scale and other residues, which are easily wiped off.



4

Highly Durable

Fireclay is an extremely tough, scratch-resistant surface that is impervious to acids and bleaches.



designed for
ENDURANCE

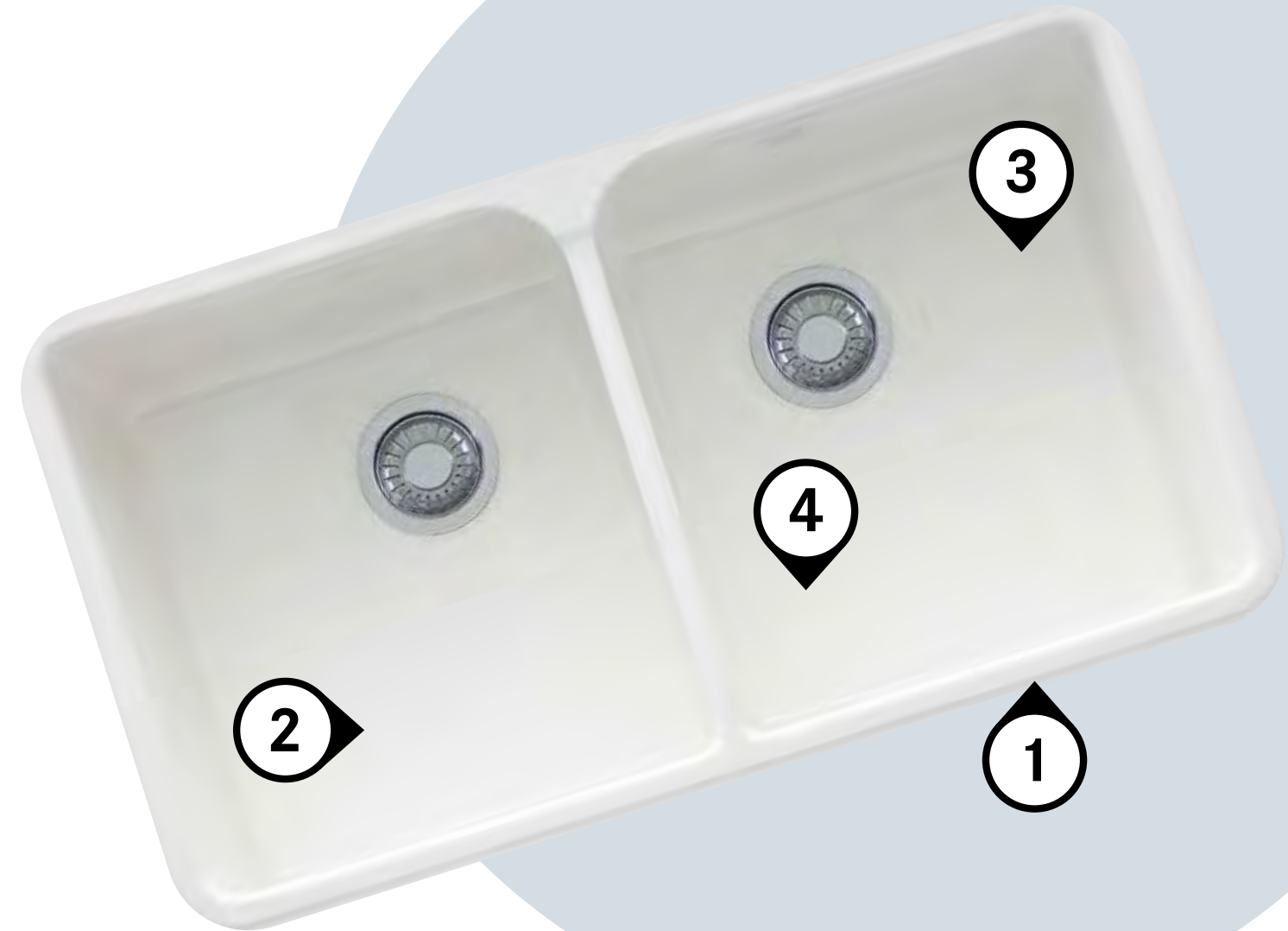

MHK110-20WH White \$585



SPECIFICATIONS

Interior Dimensions: 18 1/8" x 13 1/4" x 5 7/8"
 Exterior Dimensions: 19 1/2" x 16" x 6 3/4"
 Minimum Cabinet Size: 21"
 Weight: 40 lbs.
 Corner Radius: 12mm
 Installation: Undermount
 Apron Front

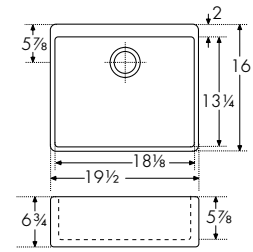

Note: Dimensions may vary by 2% (plus or minus), due to material attributes and firing process. See website for Fireclay Repair Kits. Pop-Up strainer not compatible. **Special installation required - see website.** Finished on front and sides only.

ACCESSORIES

- 7 **Cutting Board**
OA-40S
- 8 **Strainer Basket**
906
906SN

MHK110-24WH White \$775



SPECIFICATIONS

Interior Dimensions: 22" x 16 7/8" x 7 1/8"
 Exterior Dimensions: 23 5/8" x 19 7/8" x 8 1/8"
 Minimum Cabinet Size: 24"
 Weight: 58 lbs.
 Corner Radius: 12mm
 Installation: Undermount
 Apron Front

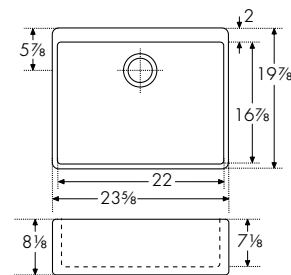

Note: Dimensions may vary by 2% (plus or minus), due to material attributes and firing process. See website for Fireclay Repair Kits. Pop-Up strainer not compatible. **Special installation required - see website.** Finished on front and sides only.

ACCESSORIES

- 1 **Bottom Grid**
MK24-36C
- 7 **Cutting Board**
OA-40S
- 8 **Strainer Basket**
906
906SN

MHK110-28WH White \$840



SPECIFICATIONS

Interior Dimensions: 26" x 17 3/8" x 7 1/8"
 Exterior Dimensions: 27 1/8" x 19 7/8" x 7 7/8"
 Minimum Cabinet Size: 30"
 Weight: 64 lbs.
 Corner Radius: 12mm
 Installation: Undermount
 Apron Front

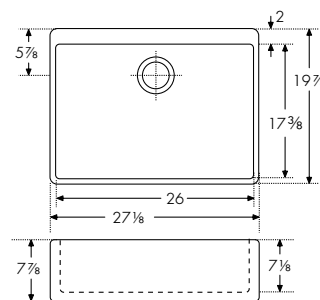

Note: Dimensions may vary by 2% (plus or minus), due to material attributes and firing process. See website for Fireclay Repair Kits. Pop-Up strainer not compatible. **Special installation required - see website.** Finished on front and sides only.

ACCESSORIES

- 2 **Bottom Grid**
MK28-36C
- 7 **Cutting Board**
OA-40S
- 8 **Strainer Basket**
906
906SN

MHK720-31WH White \$910



SPECIFICATIONS

Interior Dimensions: 29 3/4" x 17 1/2" x 7 5/8"
 Exterior Dimensions: 31 1/4" x 19 3/4" x 8 5/8"
 Minimum Cabinet Size: 33"
 Weight: 82 lbs.
 Corner Radius: 12mm
 Installation: Undermount
 Apron Front

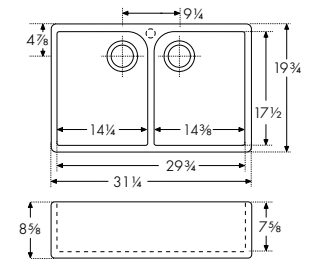

Note: Dimensions may vary by 2% (plus or minus), due to material attributes and firing process. See website for Fireclay Repair Kits. Pop-Up strainer not compatible. **Special installation required - see website.** Finished on front and sides only.

ACCESSORIES

- 3 **Bottom Grid**
MK31-36C-LH
- 4 **Bottom Grid**
MK31-36C-RH
- 7 **Cutting Board**
OA-40S
- 8 **Strainer Basket**
906
906SN

MHK720-35WH White \$1,295



SPECIFICATIONS

Interior Dimensions: 33 5/8" x 19 3/4" x 7 7/8"
 Exterior Dimensions: 35 1/2" x 21 5/8" x 8 5/8"
 Minimum Cabinet Size: 36"
 Weight: 96 lbs.
 Corner Radius: 12mm
 Installation: Undermount
 Apron Front

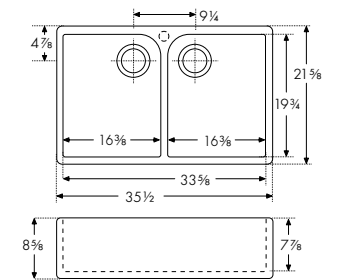

Note: Dimensions may vary by 2% (plus or minus), due to material attributes and firing process. See website for Fireclay Repair Kits. Pop-Up strainer not compatible. **Special installation required - see website.** Finished on front and sides only.

ACCESSORIES

- 5 **Bottom Grid**
MK35-36C-LH
- 6 **Bottom Grid**
MK35-36C-RH
- 7 **Cutting Board**
OA-40S
- 8 **Strainer Basket**
906
906SN

ACCESSORIES

- 1 **Bottom Grid**
21" x 15 7/8"
Coated Stainless
MK24-36C
\$230
- 2 **Bottom Grid**
25 3/16" x 15 7/8"
Coated Stainless
MK28-36C
\$255
- 3 **Bottom Grid**
17 1/16" x 13 11/16"
Coated Stainless
MK31-36C-LH
\$245
- 4 **Bottom Grid**
17 1/16" x 13 11/16"
Coated Stainless
MK31-36C-RH
\$245
- 5 **Bottom Grid**
19 3/16" x 15 3/8"
Coated Stainless
MK35-36C-LH
\$290
- 6 **Bottom Grid**
19 3/16" x 15 3/8"
Coated Stainless
MK35-36C-RH
\$290

- 7 **Cutting Board**
14 1/2" x 21 7/8"
Solid Wood
OA-40S
\$385
- 8 **Strainer Basket**
Chrome
906
\$70
Satin Nickel
906SN
\$95

Note: All accessories sold separately unless otherwise indicated. Design of custom accessories subject to change without notice. It is absolutely critical that you have the sink and any custom sink accessories on site prior to any cut or modification to the countertop. Franke will not be responsible for any errors in countertop preparation and sink installation.

Orca

With Franke's Orca fireclay sink, you'll enjoy the versatility of a **contemporary design** with a softer **classic look**. Orca is rimmed with the unique **accessory shelf** to create additional workspace without forgoing a **deep basin**. This sophisticated spacious sink is designed to meet your largest culinary challenges head-on.



Pictured: ORK110WH sink with FF5290SB faucet

Note: Color may vary between series.

Orca



1

Integrated Ledge System

The unique Franke accessory shelf turns this large sink into an extra workspace for all of your culinary needs.



2

Easy To Clean

With smooth, rounded corners and a dirt-repelling finish, your fireclay sink is easy to clean and will retain its original beauty for years.



ORK110WH White

\$1,295



SPECIFICATIONS

Interior Dimensions: 27½" x 17½" x 9"
 Exterior Dimensions: 29⅞" x 19½" x 9⅞"
 Minimum Cabinet Size: 33"
 Weight: 57 lbs.
 Integral Franke Ledge System
 Corner Radius: 70mm
 Installation: Undermount

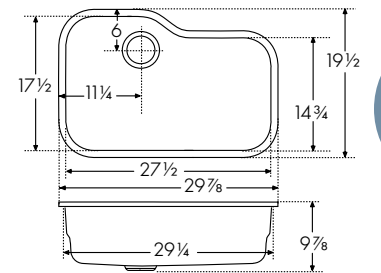

ACCESSORIES

| | | | | | |
|--------------------------------|----------------------------------|----------------------------------|----------------------------------|--|--|
| 1 Bottom Grid OK-36C | 2 Shelf Grid OK-31C-LH | 3 Shelf Grid OK-31C-RH | 4 Cutting Board OA-40S | 5 Universal Roller Mat UV-36RM | 6 Strainer Basket 906 906SN |
|--------------------------------|----------------------------------|----------------------------------|----------------------------------|--|--|

Note: Dimensions may vary by 2% (plus or minus), due to material attributes and firing process. See website for Fireclay Repair Kits. Pop-Up strainer not compatible. **Special installation required - see website.**

ACCESSORIES

| | | | | | |
|--|--|--|--|--|---|
|  1 Bottom Grid 24⅜" x 13⅞" Coated Stainless OK-36C \$245 |  2 Shelf Grid 13⅞" x 16⅞" Coated Stainless OK-31C-LH \$175 |  3 Shelf Grid 13⅞" x 13⅞" Coated Stainless OK-31C-RH \$175 |  4 Cutting Board 14½" x 21⅞" Solid Wood OA-40S \$385 |  5 Universal Roller Mat 18⅞" x 20" Stainless UV-36RM \$175 |  6 Strainer Basket Chrome 906 \$70 Satin Nickel 906SN \$95 |
|--|--|--|--|--|---|



Prestige

Renowned ceramics manufacturer Villeroy & Boch created the Prestige **single-bowl** sink in a **classic design** to suit your kitchen. The **CeramicPlus finish** ensures this sink's beauty will endure for years to come.

Note: Color may vary between series.



Pictured: PRK11021WH sink with FFP3180 faucet and DW10080 filtration faucet

Prestige

Prestige Fireclay

Prestige Fireclay



1

Easy Cleaning

A silky smooth surface, gently rounded corners and our exclusive CeramicPlus finish make Prestige fireclay easy to clean and help retain its look of luxury for years.



2

Integrated Ledge System

A shelf grid sits conveniently on the integrated ledge system, creating a higher level workspace for prepping, rinsing and cleaning.



PRK11021WH

White

\$910



SPECIFICATIONS

Interior Dimensions: 21 1/8" x 18 1/2" x 8 3/4"
 Exterior Dimensions: 23 3/8" x 20 1/2" x 9 5/8"
 Minimum Cabinet Size: 27"
 Weight: 42 lbs.
 Integral Franke Ledge System
 Corner Radius: 83mm
 Installation: Undermount

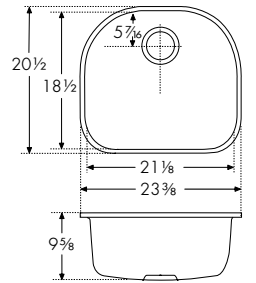

ACCESSORIES

| | | | | | | | | | |
|---|--------------------------------|---|-------------------------------|---|--------------------------------|---|--|---|--|
| 1 | Bottom Grid PK21-36S | 2 | Shelf Grid PK21-31S | 3 | Cutting Board OA-40S | 4 | Universal Roller Mat UV-36RM | 5 | Strainer Basket 906 906SN |
|---|--------------------------------|---|-------------------------------|---|--------------------------------|---|--|---|--|

Note: Dimensions may vary by 2% (plus or minus), due to material attributes and firing process. See website for Fireclay Repair Kits. Pop-Up strainer not compatible. **Special installation required - see website.** Finished on front and sides only.

ACCESSORIES

| | | | | | | | | | |
|---|--|---|---|---|---|---|---|---|--|
| 1 | Bottom Grid 17 1/2" x 15 13/16" Stainless PK21-36S \$165 | 2 | Shelf Grid 22" x 15 1/2" Stainless PK21-31S \$165 | 3 | Cutting Board 14 1/2" x 21 7/8" Solid Wood OA-40S \$385 | 4 | Universal Roller Mat 18 7/16" x 20" Stainless UV-36RM \$175 | 5 | Strainer Basket Chrome 906 \$70 Satin Nickel 906SN \$95 |
|---|--|---|---|---|---|---|---|---|--|



Pictured: CCK110-19WH sink with FFP3 180 faucet and DW10080 filtration faucet



Cisterna

Created by **Villeroy & Boch** with a **classic design** offered in **three sizes**, the Cisterna fireclay sink is a perfect fit for the kitchen and beyond. Use the smallest size as a bar or prep sink – or pair it with a larger size to create a unique two-bowl design.

Note: Color may vary between series.

Cisterna

Cisterna
Fireclay

1

Exceptionally Durable

Liquid ceramic undergoes a thorough refinement and firing process resulting in a beautifully smooth and hard wearing, highly durable sink.



2

Kitchen Essentials

An optional fitted grid protects the bottom of the sink. Add a cutting board and roller mat to complete your perfect workspace.



3

Sound Absorbing

Fireclay is a naturally sound-absorbing material that reduces the noise caused by a garbage disposal or running water.



4

Simply Stain Resistant

Don't worry about red wine, coffee and other food stains. The CeramicPlus finish makes our fireclay sinks simple to clean. Soap and water are all it takes.



crafted for
LONGEVITY



Cisterna
Fireclay

CCK110-13WH White \$715



SPECIFICATIONS

Interior Dimensions: 12⁵/₈" x 15³/₈" x 6⁷/₈"
 Exterior Dimensions: 14³/₈" x 17¹/₈" x 7⁵/₈"
 Minimum Cabinet Size: 18"
 Weight: 29 lbs.
 Corner Radius: 68mm
 Installation: Undermount

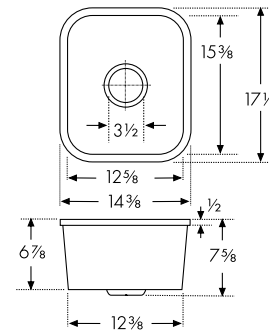

Note: Dimensions may vary by 2% (plus or minus), due to material attributes and firing process. See website for Fireclay Repair Kits. Pop-Up strainer not compatible. **Special installation required - see website.**

ACCESSORIES

- | | | | |
|------------------------------------|------------------------------------|--|--|
| 1 Bottom Grid CK13-36C | 4 Cutting Board OA-40S | 5 Universal Roller Mat UV-36RM | 6 Strainer Basket 906 906SN |
|------------------------------------|------------------------------------|--|--|

ACCESSORIES



- 1 | **Bottom Grid**
13³/₄" x 10¹⁵/₁₆"
Coated Stainless
CK13-36C
\$220



- 2 | **Bottom Grid**
13³/₄" x 13³/₄"
Coated Stainless
CK15-36C
\$230



- 3 | **Bottom Grid**
18" x 13¹/₁₆"
Coated Stainless
CK19-36C
\$245



- 4 | **Cutting Board**
14¹/₂" x 21⁷/₈"
Solid Wood
OA-40S
\$385



- 5 | **Universal Roller Mat**
18⁷/₁₆" x 20"
Stainless
UV-36RM
\$175



- 6 | **Strainer Basket**
Chrome
906
\$70
Satin Nickel
906SN
\$95

CCK110-15WH White \$715



SPECIFICATIONS

Interior Dimensions: 15³/₈" x 15³/₈" x 6⁷/₈"
 Exterior Dimensions: 17¹/₂" x 17¹/₂" x 7⁵/₈"
 Minimum Cabinet Size: 21"
 Weight: 33 lbs.
 Corner Radius: 68mm
 Installation: Undermount

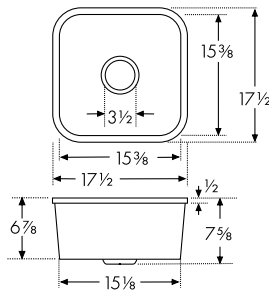

Note: Dimensions may vary by 2% (plus or minus), due to material attributes and firing process. See website for Fireclay Repair Kits. Pop-Up strainer not compatible. **Special installation required - see website.**

ACCESSORIES

- | | | | |
|------------------------------------|------------------------------------|--|--|
| 2 Bottom Grid CK15-36C | 4 Cutting Board OA-40S | 5 Universal Roller Mat UV-36RM | 6 Strainer Basket 906 906SN |
|------------------------------------|------------------------------------|--|--|

CCK110-19WH White \$775



SPECIFICATIONS

Interior Dimensions: 19⁵/₈" x 15³/₈" x 6⁷/₈"
 Exterior Dimensions: 21⁵/₈" x 17³/₈" x 7⁵/₈"
 Minimum Cabinet Size: 27"
 Weight: 39 lbs.
 Corner Radius: 68mm
 Installation: Undermount

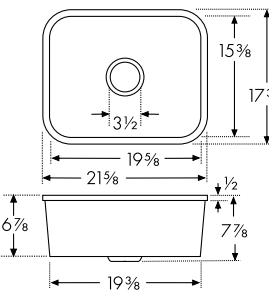

Note: Dimensions may vary by 2% (plus or minus), due to material attributes and firing process. See website for Fireclay Repair Kits. Pop-Up strainer not compatible. **Special installation required - see website.**

ACCESSORIES

- | | | | |
|------------------------------------|------------------------------------|--|--|
| 3 Bottom Grid CK19-36C | 4 Cutting Board OA-40S | 5 Universal Roller Mat UV-36RM | 6 Strainer Basket 906 906SN |
|------------------------------------|------------------------------------|--|--|



Granite Sinks

| | |
|---------|---------|
| Peak | 138-145 |
| Urban | 146-153 |
| Maris | 154-159 |
| Kubus | 160-163 |
| Ellipse | 164-171 |
| Primo | 172-175 |
| Gravity | 176-179 |
| Quantum | 180-183 |



Color Your Kitchen with Granite

Sinks made of granite bring a natural look and long-lasting beauty to your kitchen. Made from 80% quartz sand and 20% hard acrylic resin, Franke's processed granite has a subtle shine and feels warm to the touch.

WONDERFUL FOR ACTIVE FAMILIES

Franke is recognized as a pioneer in the development of granite compounds for sinks. The Sanitized® hygiene function reduces the growth of biofilm and bacterial microbes, ensuring that your sink is clean. Durable granite sinks resist scratches and stains and are easy to clean. That means less work, giving you more time to enjoy the things you love and the peace of mind in knowing your kitchen is clean.

COLORS THAT CREATE ATMOSPHERE

Practicality meets style with durable, scratch-and-stain-resistant granite sinks in warm, sophisticated shades inspired by nature and on-trend with today's designs. Choose warm tones for a classic look or go contemporary with grey and matte black.



Colors may vary by model.

Pictured: PKG11031OYS sink with FF3120MBK faucet

Peak

Available in **single-bowl** and **double-bowl** options in **eight finish colors**, Peak granite sinks let you create the kitchen that fits your style. A wide range of accessories allows you to create the ultimate workspace for the way you use your sink.



Pictured: PKG 160STO sink with FF4250 faucet

Peak

Peak
Granite

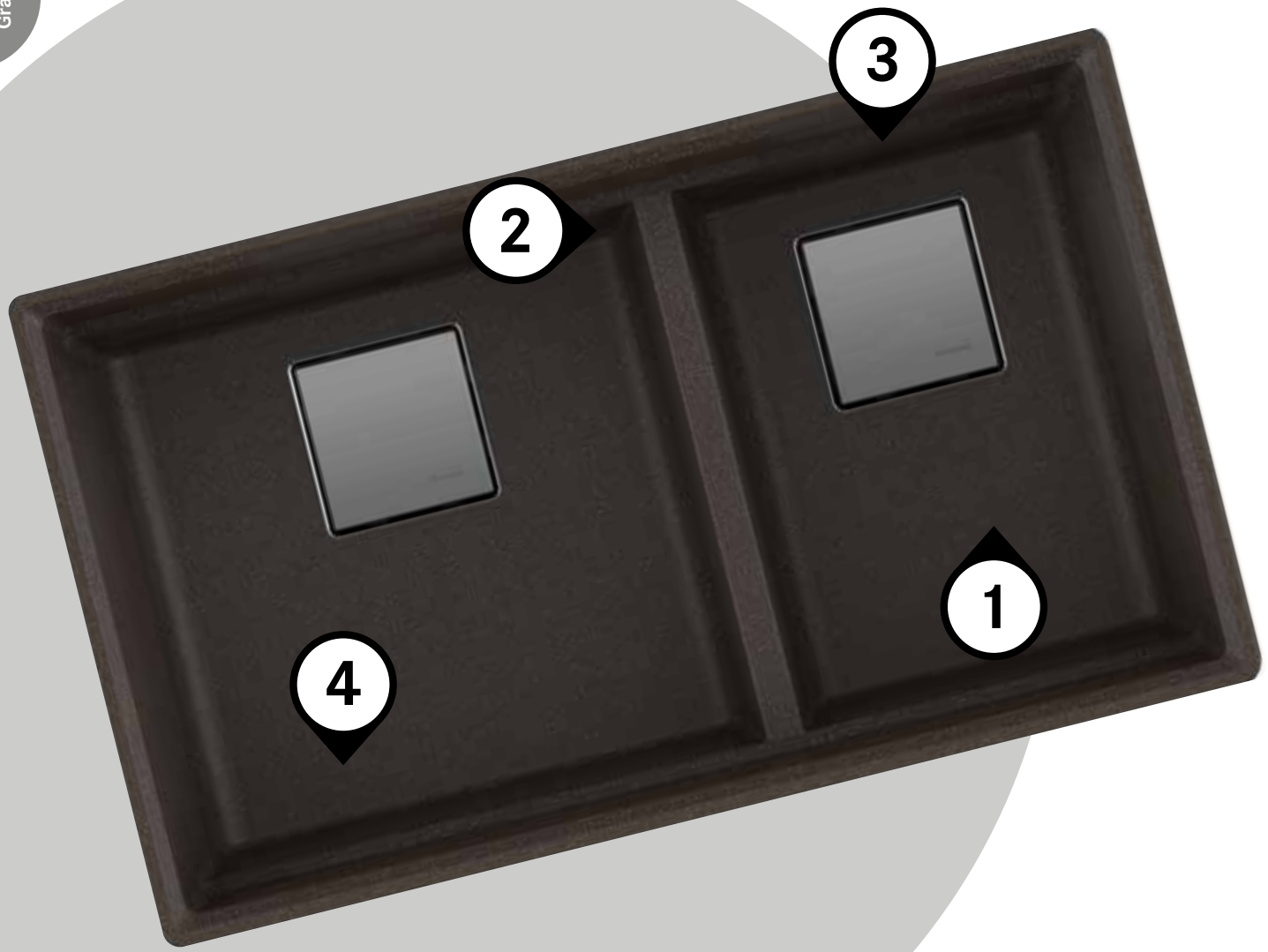

make it
MODERN

1

Sophisticated Colors

Whether your style is high contrast, monochromatic or warm complementary colors, a choice of eight finishes lets you define the perfect look.



2

Modern Style

Clean lines, tight corners and a hidden drain add a contemporary edge to this line of sinks.



Peak
Granite

3

Integrated Ledge

The integrated ledge enhances your workspace by allowing you to work directly over the sink. Custom-fit accessories streamline the workflow.



4

Sanitized®

Our treated granite reduces bacteria and microbe growth, giving the sink lasting protection.



- PKG11014ONY Onyx \$540
- PKG11014MOC Mocha \$540
- PKG11014STO Storm \$540
- PKG11014OYS Oyster \$540
- PKG11014CHA Champagne \$540
- PKG11014SHG Stone Grey \$540
- NEW PKG11014PWT Polar White \$540
- NEW PKG11014MBK Matte Black \$540

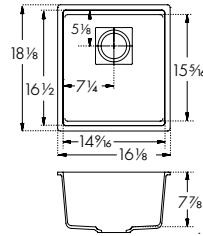

SPECIFICATIONS

Interior Dimensions: 14⁹/₁₆" x 16¹/₂" x 7⁷/₈"
 Exterior Dimensions: 16¹/₈" x 18¹/₈"
 Minimum Cabinet Size: 21"
 Weight: 20 lbs.
 Integral Franke Ledge System
 Corner Radius: 10mm
 Installation: Undermount

- PKG11031ONY Onyx \$760
- PKG11031MOC Mocha \$760
- PKG11031STO Storm \$760
- PKG11031OYS Oyster \$760
- PKG11031CHA Champagne \$760
- PKG11031SHG Stone Grey \$760
- NEW PKG11031PWT Polar White \$760
- NEW PKG11031MBK Matte Black \$760

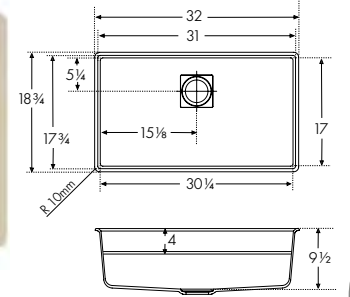

SPECIFICATIONS

Interior Dimensions: 31" x 17³/₄" x 9¹/₂"
 Exterior Dimensions: 32" x 18³/₄"
 Minimum Cabinet Size: 36"
 Weight: 38 lbs.
 Integral Franke Ledge System
 Corner Radius: 10mm
 Installation: Undermount

ACCESSORIES

- | | | | | |
|--|---|-----------------------------------|--|---|
| 1 Bottom Roller Mat PKG14-36RM | 6 Shelf Roller Mat PKG14-31RM | 7 Cutting Board PG2-40S | 9 Strainer Basket 906 906SN | 10 Drain Cover PKGCVR Included |
|--|---|-----------------------------------|--|---|

ACCESSORIES

- | | | | | | |
|--|-----------------------------------|---|----------------------------------|--|---|
| 3 Bottom Roller Mat PKG31-36RM | 4 Bottom Grid PKG31-36S | 5 Shelf Roller Mat PKG18-31RM | 8 Cutting Board PG-40S | 9 Strainer Basket 906 906SN | 10 Drain Cover PKGCVR Included |
|--|-----------------------------------|---|----------------------------------|--|---|

- PKG11020ONY Onyx \$650
- PKG11020MOC Mocha \$650
- PKG11020STO Storm \$650
- PKG11020OYS Oyster \$650
- PKG11020CHA Champagne \$650
- PKG11020SHG Stone Grey \$650
- NEW PKG11020PWT Polar White \$650
- NEW PKG11020MBK Matte Black \$650

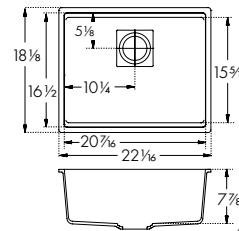

SPECIFICATIONS

Interior Dimensions: 20⁷/₁₆" x 16¹/₂" x 7⁷/₈"
 Exterior Dimensions: 22¹/₁₆" x 18¹/₈"
 Minimum Cabinet Size: 27"
 Weight: 24 lbs.
 Integral Franke Ledge System
 Corner Radius: 10mm
 Installation: Undermount

ACCESSORIES

- | | | | | |
|---|--|--|---|--|
| 1 Bottom Roller Mat 11 ¹ / ₁₆ " x 13 ¹ / ₂ " Stainless PKG14-36RM \$170 | 2 Bottom Roller Mat 17 ³ / ₄ " x 13 ¹ / ₂ " Stainless PKG20-36RM \$195 | 3 Bottom Roller Mat 25 ³ / ₄ " x 13 ³ / ₄ " Stainless PKG31-36RM \$220 | 4 Bottom Grid 28 ¹ / ₂ " x 14 ¹ / ₂ " Stainless PKG31-36S \$230 | 5 Shelf Roller Mat 18 ⁷ / ₁₆ " x 16 ³ / ₁₆ " Stainless PKG18-31RM \$165 |
| 6 Shelf Roller Mat 11 ³ / ₄ " x 16 ¹ / ₈ " Stainless PKG14-31RM \$135 | 7 Cutting Board 11" x 17 ⁷ / ₁₆ " Solid Wood PG2-40S \$215 | 8 Cutting Board 14 ³ / ₈ " x 18 ³ / ₈ " Solid Wood PG-40S \$225 | 9 Strainer Basket Chrome 906 \$70 Satin Nickel 906SN \$95 | 10 Drain Cover 4 ⁷ / ₈ " x 4 ⁷ / ₈ " Stainless PKGCVR \$90 One included |

ACCESSORIES

- | | | | | |
|--|---|-----------------------------------|--|---|
| 2 Bottom Roller Mat PKG20-36RM | 6 Shelf Roller Mat PKG14-31RM | 7 Cutting Board PG2-40S | 9 Strainer Basket 906 906SN | 10 Drain Cover PKGCVR Included |
|--|---|-----------------------------------|--|---|

Note: All accessories sold separately unless otherwise indicated. Design of custom accessories subject to change without notice. It is absolutely critical that you have the sink and any custom sink accessories on site prior to any cut or modification to the countertop. Franke will not be responsible for any errors in countertop preparation and sink installation.

Note: All accessories sold separately unless otherwise indicated. Design of custom accessories subject to change without notice. It is absolutely critical that you have the sink and any custom sink accessories on site prior to any cut or modification to the countertop. Franke will not be responsible for any errors in countertop preparation and sink installation.

Peak Granite

- PKG160ONY
- PKG160MOC
- PKG160STO
- PKG160OYS
- PKG160CHA
- PKG160SHG
- NEW** PKG160PWT
- NEW** PKG160MBK

- Onyx \$830
- Mocha \$830
- Storm \$830
- Oyster \$830
- Champagne \$830
- Stone Grey \$830
- Polar White \$830
- Matte Black \$830

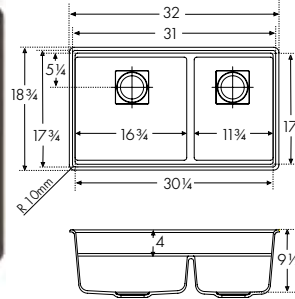









SPECIFICATIONS

Interior Dimensions: 31" x 17 3/4" x 9 1/2"
 Exterior Dimensions: 32" x 18 3/4"
 Minimum Cabinet Size: 36"
 Weight: 40 lbs.
 Integral Franke Ledge System
 Corner Radius: 10mm
 Installation: Undermount

ACCESSORIES

- | | | | | | | | |
|--|--|-----------------------------------|-----------------------------------|---|----------------------------------|--|--|
| 1 Bottom Roller Mat PKG17-36RM | 2 Bottom Roller Mat PKG12-36RM | 3 Bottom Grid PKG17-36S | 4 Bottom Grid PKG12-36S | 5 Shelf Roller Mat PKG18-31RM | 6 Cutting Board PG-40S | 7 Strainer Basket 906 906SN | 8 Drain Cover PKGCVR Included |
|--|--|-----------------------------------|-----------------------------------|---|----------------------------------|--|--|

ACCESSORIES

- | | | | |
|---|--|---|--|
|  1 Bottom Roller Mat 15" x 13 3/4" Stainless PKG17-36RM \$175 |  2 Bottom Roller Mat 9 3/4" x 13 3/4" Stainless PKG12-36RM \$140 |  3 Bottom Grid 15 1/2" x 14 1/2" Stainless PKG17-36S \$175 |  4 Bottom Grid 10 1/2" x 14 1/2" Stainless PKG12-36S \$150 |
|  5 Shelf Roller Mat 18 7/8" x 16 3/8" Stainless PKG18-31RM \$165 |  6 Cutting Board 14 3/8" x 18 3/8" Solid Wood PG-40S \$230 |  7 Strainer Basket Chrome 906 \$70 Satin Nickel 906SN \$95 |  8 Drain Cover 4 7/8" x 4 7/8" Stainless PKGCVR \$90 Two included with PKG160 series |



Pictured: PKG160ONY sink with FFPD5400 faucet



Pictured: UBG120-32ONY sink with FF3801 faucet



Urban

Franke Urban brings ultra-modern design to a durable sink that is perfect for today's home chef. Made of granite, a blend of quartz and acrylic resin, Franke Urban is **easy to clean, scratch resistant** and **impact resistant** to retain its beauty. With an **extensive color palette** and a **variety of sizes**, Urban is sure to fit your space and your style.

Urban

1

Germ Resistant

Franke granite is treated with Sanitized®, that helps to reduce bacteria and microbe growth, giving the sink lasting protection.



2

Earthy Color Palette

The natural texture of granite combined with neutral, warm colors help define a modern style.



3

Superbly Hard Wearing

Composed of 80% quartz and 20% hard acrylic resin, this material is scratch, stain and impact resistant.



4

Enhanced Functionality

Optimize your workspace with custom-fit accessories that allow you to work over your sink, keeping your countertops clear.



designed with an
ARTISTIC FLAIR

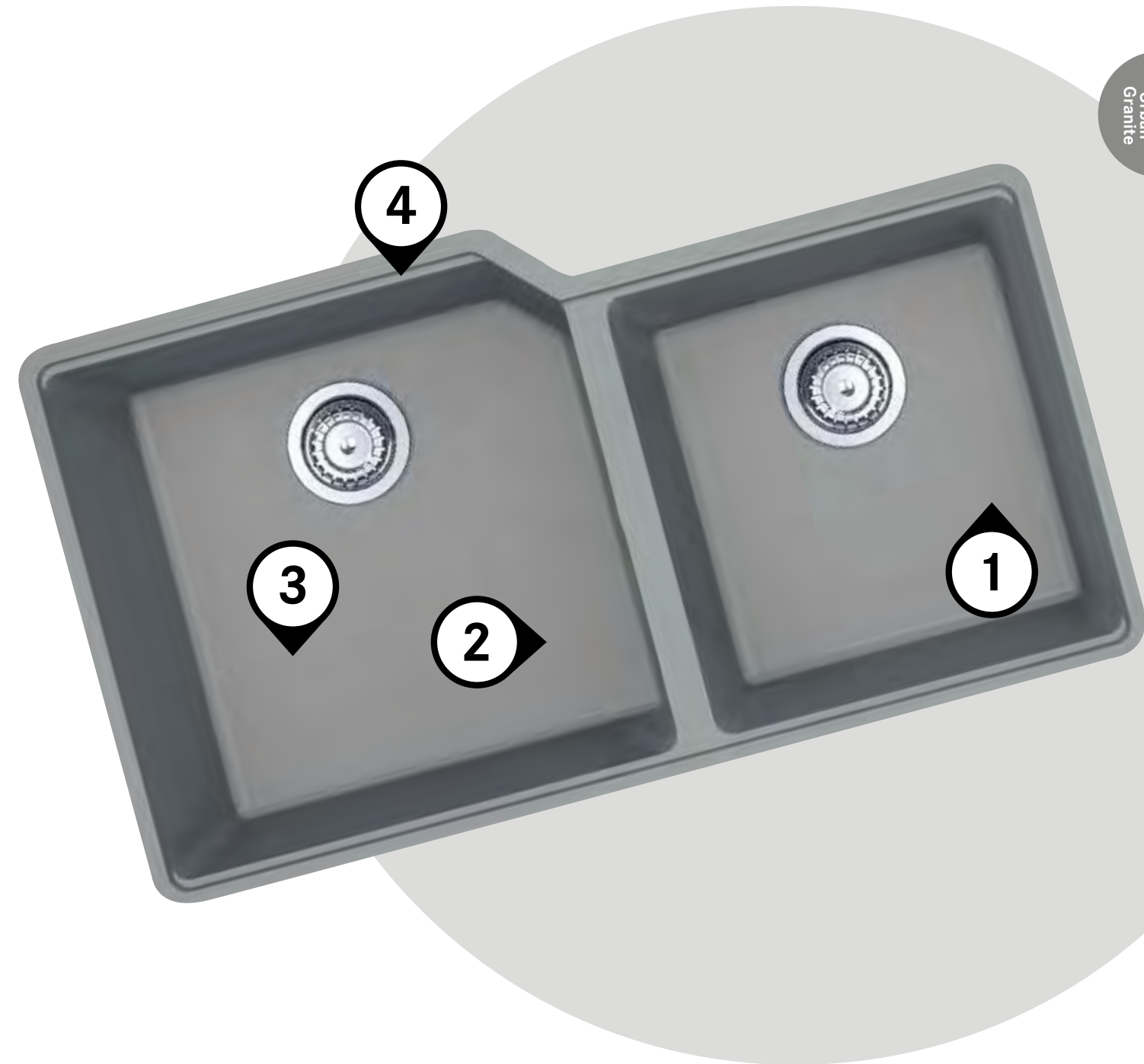

- UBG110-20ONY Onyx \$540
- UBG110-20MOC Mocha \$540
- UBG110-20STO Storm \$540
- NEW UBG110-20CHA Champagne \$540
- UBG110-20SHG Stone Grey \$540
- NEW UBG110-20PWT Polar White \$540
- NEW UBG110-20MBK Matte Black \$540

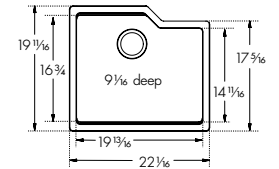

SPECIFICATIONS

Interior Dimensions: 19 1/16" x 16 3/4" x 9 1/16"
 Exterior Dimensions: 22 1/16" x 19 1/16"
 Minimum Cabinet Size: 27"
 Weight: 25 lbs.
 Corner Radius: 15mm
 Installation: Undermount

| ACCESSORIES | | | |
|----------------------------------|-------------------------------|------------------------------------|--|
| 1 Bottom Grid BG400S | 5 Colander PX-70S | 6 Cutting Board UG-40S | 7 Strainer Basket 906 906SN |

- UBG110-28ONY Onyx \$605
- UBG110-28MOC Mocha \$605
- UBG110-28STO Storm \$605
- NEW UBG110-28CHA Champagne \$605
- UBG110-28SHG Stone Grey \$605
- NEW UBG110-28PWT Polar White \$605
- NEW UBG110-28MBK Matte Black \$605

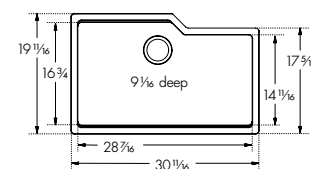

SPECIFICATIONS

Interior Dimensions: 28 7/16" x 16 3/4" x 9 1/16"
 Exterior Dimensions: 30 1/16" x 19 1/16"
 Minimum Cabinet Size: 36"
 Weight: 33 lbs.
 Corner Radius: 15mm
 Installation: Undermount

| ACCESSORIES | | | |
|----------------------------------|-------------------------------|------------------------------------|--|
| 2 Bottom Grid BG410S | 5 Colander PX-70S | 6 Cutting Board UG-40S | 7 Strainer Basket 906 906SN |

- UBG120-28ONY Onyx \$630
- UBG120-28MOC Mocha \$630
- UBG120-28STO Storm \$630
- NEW UBG120-28CHA Champagne \$630
- UBG120-28SHG Stone Grey \$630
- NEW UBG120-28PWT Polar White \$630
- NEW UBG120-28MBK Matte Black \$630

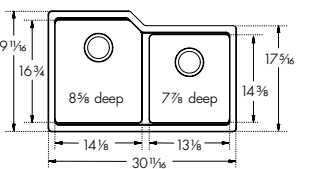

SPECIFICATIONS

Interior Dimensions: 28 7/16" x 16 3/4" x 8 5/8" x 7 7/8"
 Exterior Dimensions: 30 1/16" x 19 1/16"
 Minimum Cabinet Size: 36"
 Weight: 35 lbs.
 Corner Radius: 15mm
 Installation: Undermount

| ACCESSORIES | | | | |
|----------------------------------|----------------------------------|-------------------------------|------------------------------------|--|
| 3 Bottom Grid BG430S | 4 Bottom Grid BG440S | 5 Colander PX-70S | 6 Cutting Board UG-40S | 7 Strainer Basket 906 906SN |

ACCESSORIES

- 1 | **Bottom Grid**
18 1/4" x 15 9/32"
Stainless
BG400S
\$110
- 2 | **Bottom Grid**
26 17/32" x 15 9/32"
Stainless
BG410S
\$160
- 3 | **Bottom Grid**
12 11/32" x 15 3/32"
Stainless
BG430S
\$105
- 4 | **Bottom Grid**
11 3/4" x 12 15/16"
Stainless
BG440S
\$100
- 5 | **Colander**
6 1/8" x 17 5/16" x 2 1/8"
Stainless
PX-70S
\$220
- 6 | **Cutting Board**
10 13/16" x 17 1/4"
Solid Wood
UG-40S
\$135
- 7 | **Strainer Basket**
Chrome
906
\$70

Satin Nickel
906SN
\$95

- UBG120-32ONY Onyx \$645
- UBG120-32MOC Mocha \$645
- UBG120-32STO Storm \$645
- NEW UBG120-32CHA Champagne \$645
- UBG120-32SHG Stone Grey \$645
- NEW UBG120-32PWT Polar White \$645
- NEW UBG120-32MBK Matte Black \$645

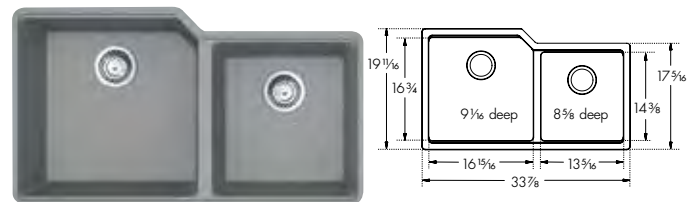

SPECIFICATIONS

Interior Dimensions: 31 5/8" x 16 3/4" x 9 1/16" x 8 5/8"
 Exterior Dimensions: 33 7/8" x 19 1/16"
 Minimum Cabinet Size: 39"
 Weight: 40 lbs.
 Corner Radius: 15mm
 Installation: Undermount

ACCESSORIES

- | | | | | |
|--------------------------------|--------------------------------|-----------------------------|----------------------------------|--|
| 1 Bottom Grid BG450S | 2 Bottom Grid BG430S | 3 Colander PX-70S | 4 Cutting Board UG-40S | 5 Strainer Basket 906 906SN |
|--------------------------------|--------------------------------|-----------------------------|----------------------------------|--|

ACCESSORIES

- | | | | | |
|--|---|--|---|--|
|  |  |  |  |  |
| 1 Bottom Grid 15 7/32" x 15 3/32" Stainless BG450S \$115 | 2 Bottom Grid 12 11/32" x 15 3/32" Stainless BG430S \$105 | 3 Colander 6 1/8" x 17 5/16" x 2 1/8" Stainless PX-70S \$220 | 4 Cutting Board 10 19/16" x 17 1/4" Solid Wood UG-40S \$135 | 5 Strainer Basket Chrome 906 \$70 Satin Nickel 906SN \$95 |



Pictured: UBG110-20SHG sink with FF3800 faucet



Pictured: MAG6 1023PWT sink with FF3807 faucet



Maris

Bring the beauty of Franke granite to the laundry room with Maris, a single-bowl sink with **exceptionally spacious size** and a wealth of features. **Durable, scratch-and-stain resistant**, this granite sink is also **bacteria resistant** thanks to the **Sanitized® treatment**. Available as a topmount or undermount in six colors that enhance most any design style, Maris is equally at home in the kitchen.

Maris

Maris
Granite

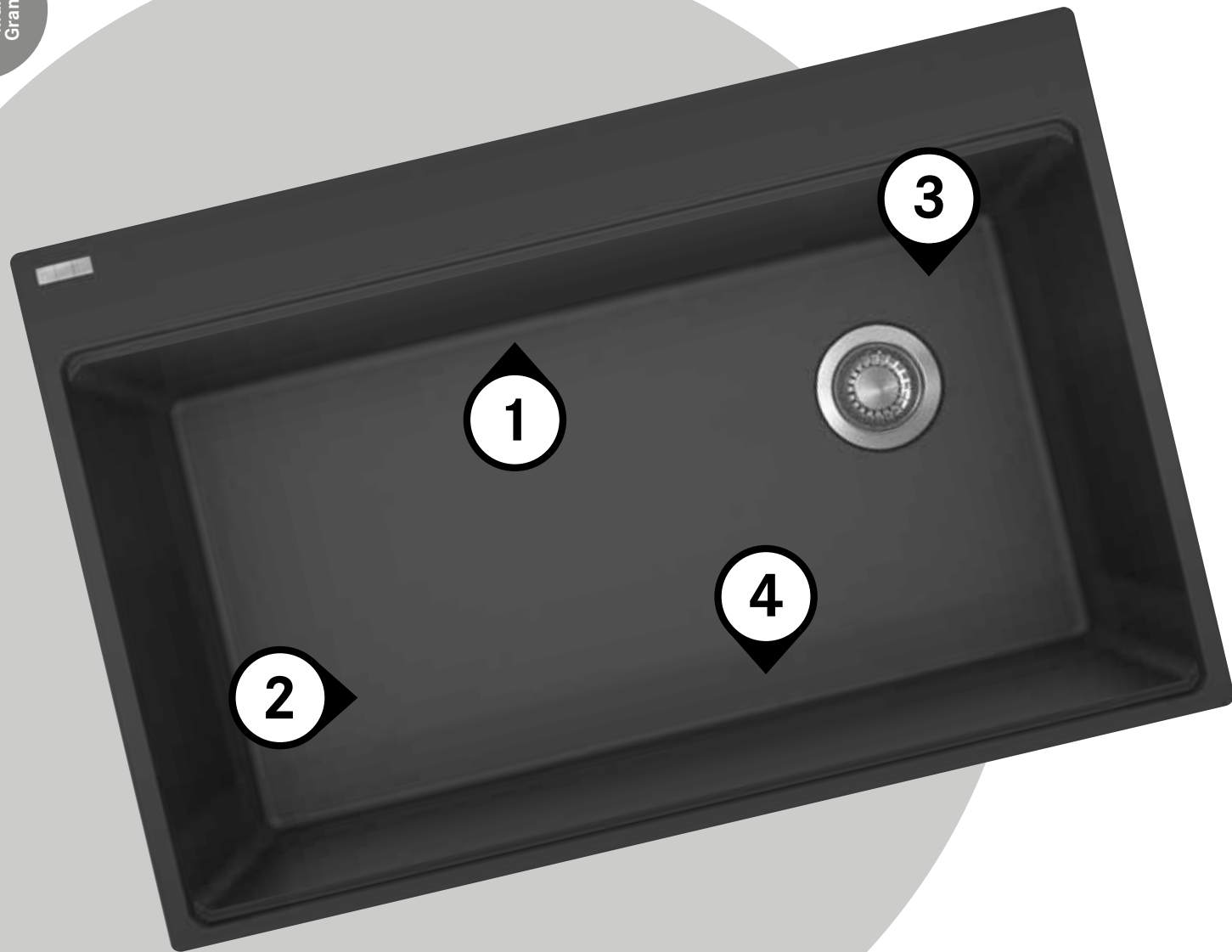

**spacious and
HARDWORKING**

1

Multi-functional Utility Sink

These generous size sinks are ideal for any busy laundry room or kitchen. They can be used for cleanup, washing pets, washing clothes or for whatever you may need.



2

Superbly Hard Wearing

Our processed granite is made of 80% quartz sand and 20% hard acrylic resin, which means your sink will stand up to use and retain its attractive appearance, with only soap and water cleanup.



3

Space-Saving Design

The flat-bottom design creates more room for big tasks without blocking the flow of water. A tight-corner radius helps maximize the sink's interior while the offset rear drain makes the most of cabinet space beneath the sink.



4

Perfect Functional Addition

Your laundry room and kitchen are hubs of household chores, but that doesn't mean your sink has to look utilitarian. Maris brings a modern flair with clean lines and a choice of six warm colors.



Maris
Granite

- NEW** MAG61023ONY Onyx \$625
- NEW** MAG61023OYS Oyster \$625
- NEW** MAG61023CHA Champagne \$625
- NEW** MAG61023SHG Stone Grey \$625
- NEW** MAG61023PWT Polar White \$625
- NEW** MAG61023MBK Matte Black \$625

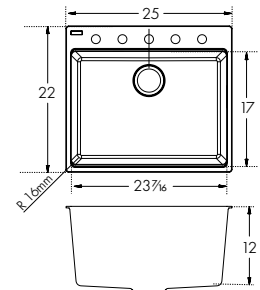

SPECIFICATIONS

Interior Dimensions: 23⁷/₁₆" x 17" x 12"
 Exterior Dimensions: 25" x 22"
 Minimum Cabinet Size: 27"
 Weight: 35 lbs.
 Corner Radius: 16mm
 Installation: Dual Mount
 Pre-drilled Faucet Hole: 1 to 5

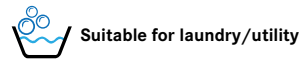

ACCESSORIES

- 2** Roller Mat MA-17-31LRM
- 4** Colander MA-70S
- 5** Strainer Basket 906 906SN

- NEW** MAG61031OW-ONY Onyx \$625
- NEW** MAG61031OW-OYS Oyster \$625
- NEW** MAG61031OW-CHA Champagne \$625
- NEW** MAG61031OW-SHG Stone Grey \$625
- NEW** MAG61031OW-PWT Polar White \$625
- NEW** MAG61031OW-MBK Matte Black \$625

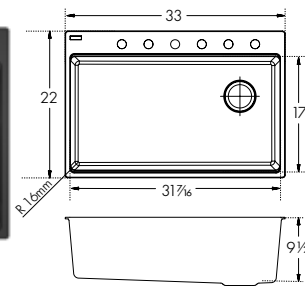

SPECIFICATIONS

Interior Dimensions: 31⁷/₁₆" x 17" x 9¹/₂"
 Exterior Dimensions: 33" x 22"
 Minimum Cabinet Size: 36"
 Weight: 37 lbs.
 Corner Radius: 16mm
 Installation: Topmount
 Pre-drilled Faucet Hole: 1 to 6

ACCESSORIES

- 1** Bottom Grid MA-31-36S
- 3** Roller Mat MA-31RM
- 4** Colander MA-70S
- 5** Cutting Board MA-40S
- 6** Strainer Basket 906 906SN

- NEW** MAG11031OW-ONY Onyx \$645
- NEW** MAG11031OW-OYS Oyster \$645
- NEW** MAG11031OW-CHA Champagne \$645
- NEW** MAG11031OW-SHG Stone Grey \$645
- NEW** MAG11031OW-PWT Polar White \$645
- NEW** MAG11031OW-MBK Matte Black \$645

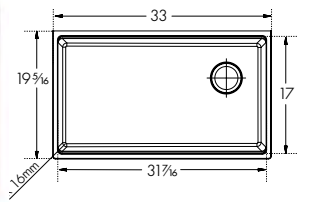

SPECIFICATIONS

Interior Dimensions: 31⁷/₁₆" x 17" x 9¹/₂"
 Exterior Dimensions: 33" x 19⁵/₁₆"
 Minimum Cabinet Size: 36"
 Weight: 37 lbs.
 Corner Radius: 16mm
 Installation: Undermount

ACCESSORIES

- 1** Bottom Grid MA-31-36S
- 3** Roller Mat MA-31RM
- 4** Colander MA-70S
- 5** Cutting Board MA-40S
- 6** Strainer Basket 906 906SN

ACCESSORIES

- 1** Bottom Grid (Left) 14⁷/₈" x 15¹⁵/₃₂" (Right) 14⁷/₈" x 15¹⁵/₃₂" Stainless MA-31-36S **\$260**
- 2** Roller Mat 18⁷/₁₆" x 17¹⁷/₃₂" Stainless MA-17-31LRM **\$160**
- 3** Roller Mat 18⁷/₈" x 17⁵/₁₆" Stainless MA-31RM **\$160**
- 4** Colander 6⁵/₃₂" x 17¹⁷/₃₂" Stainless MA-70S **\$210**
- 5** Cutting Board 11²¹/₃₂" x 17⁵/₈" Solid Wood MA-40S **\$185**
- 6** Strainer Basket Chrome 906 **\$70**
Satin Nickel 906SN **\$95**



Kubus

Kubus fits wherever you need it, whether it's your primary kitchen sink or in a prep area. Choose from **six granite colors** to create the kitchen workspace you've always imagined.



Pictured: KBG11031SHG sink with FF3807 faucet

Kubus

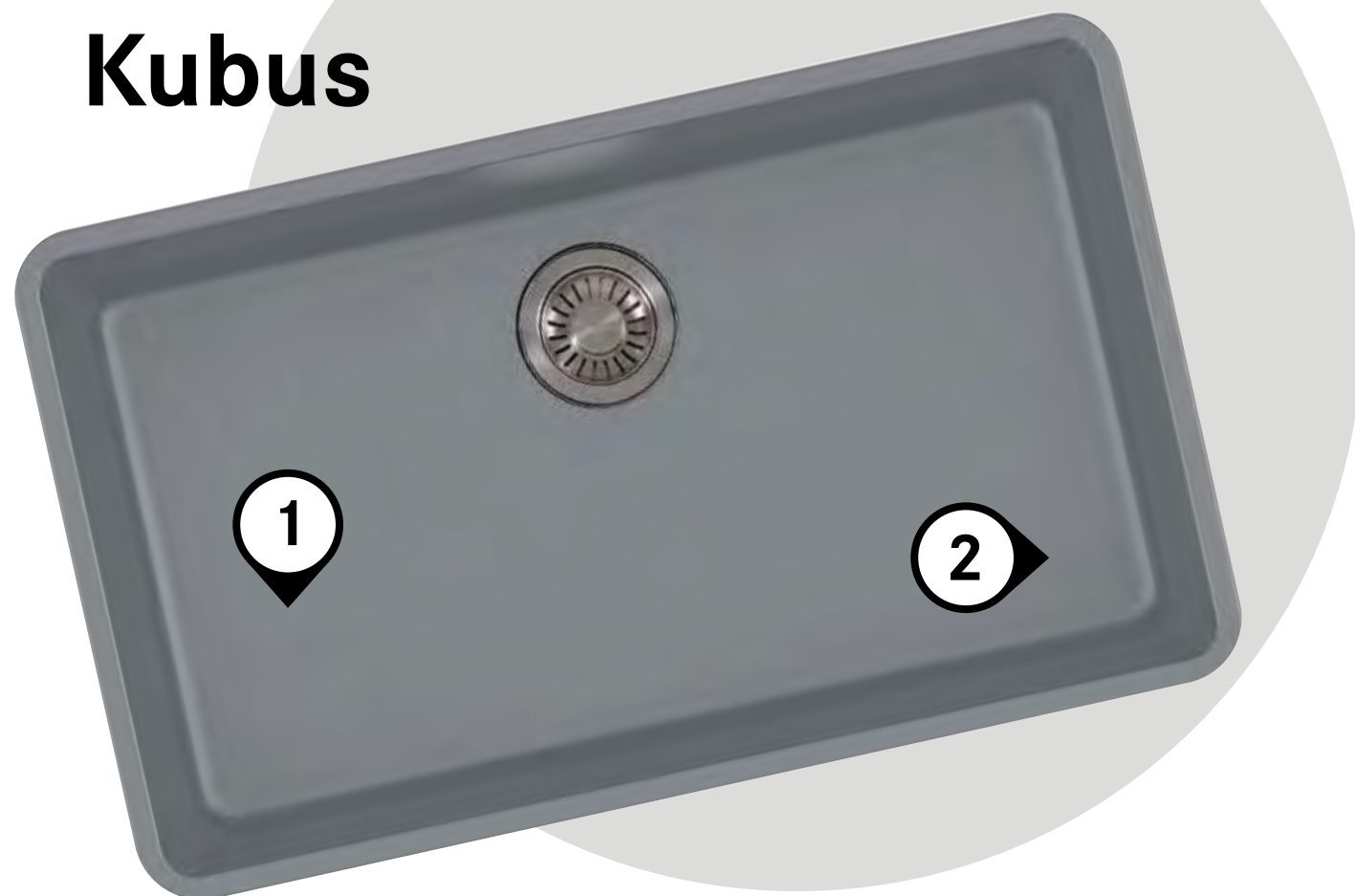

1

2

1

Sized Right

Whether you need a roomy and spacious sink for meals and cleanup or a compact sink to use for prep or as a bar sink, Kubus offers options to make everyday kitchen tasks a breeze.



2

Easy Care

Cleanup is simple with a Franke granite sink. Soap and water are all it takes. Our Sanitized® treatment makes your Kubus sink bacteria resistant – an added plus for busy kitchens and active families.



- KBG11013ONY ■ Onyx \$520
- KBG11013MOC ■ Mocha \$520
- KBG11013STO ■ Storm \$520
- KBG11013OYS ■ Oyster \$520
- KBG11013CHA ■ Champagne \$520
- KBG11013SHG ■ Stone Grey \$520

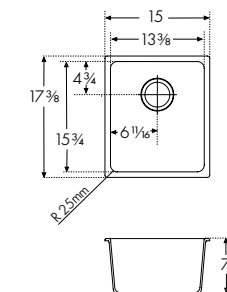

SPECIFICATIONS

Interior Dimensions: 13 3/8" x 15 3/4" x 7 7/8"
 Exterior Dimensions: 15" x 17 3/8"
 Minimum Cabinet Size: 21"
 Weight: 18 lbs.
 Corner Radius: 25mm
 Installation: Undermount

ACCESSORIES

- 1 **Bottom Grid**
KBG13-36S
- 3 **Universal Roller Mat**
UV-36RM
- 4 **Strainer Basket**
906
906SN

- KBG11031ONY ■ Onyx \$630
- KBG11031MOC ■ Mocha \$630
- KBG11031STO ■ Storm \$630
- KBG11031OYS ■ Oyster \$630
- KBG11031CHA ■ Champagne \$630
- KBG11031SHG ■ Stone Grey \$630

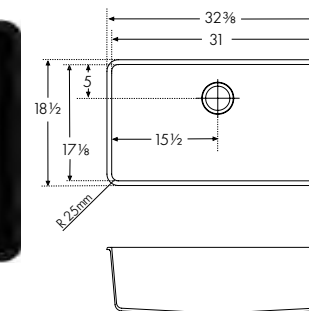

SPECIFICATIONS

Interior Dimensions: 31" x 17 1/8" x 9 1/2"
 Exterior Dimensions: 32 3/8" x 18 1/2"
 Minimum Cabinet Size: 36"
 Weight: 39 lbs.
 Corner Radius: 25mm
 Installation: Undermount

ACCESSORIES

- 2 **Bottom Grid**
KBG31-36S
- 3 **Universal Roller Mat**
UV-36RM
- 4 **Strainer Basket**
906
906SN

ACCESSORIES

- 1 **Bottom Grid**
13 1/8" x 14 1/8"
Stainless
KBG13-36S
\$135
- 2 **Bottom Grid**
29 1/2" x 15 1/8"
Stainless
KBG31-36S
\$220
- 3 **Universal Roller Mat**
18 7/8" x 20"
Stainless
UV-36RM
\$175
- 4 **Strainer Basket**
Chrome
906
\$70
Satin Nickel
906SN
\$95

Note: All accessories sold separately unless otherwise indicated. Design of custom accessories subject to change without notice. It is absolutely critical that you have the sink and any custom sink accessories on site prior to any cut or modification to the countertop. Franke will not be responsible for any errors in countertop preparation and sink installation.



Ellipse

Available in **several configurations**, there's an Ellipse sink that's perfect for your space. Franke granite sinks are made from **80% quartz**, the hardest component of granite, and bonded using **high-quality acrylic resins**, for a sink that will serve you for years to come.



Pictured: ELG1200NY sink with FF4420 faucet

Ellipse

1

Germ Resistant

Franke granite is treated with Sanitized®, which helps to reduce bacteria and microbe growth, giving the sink lasting protection.



2

Natural Beauty

The collection of Ellipse Granite sinks are offered in a variety of warm, sophisticated and enveloping shades, inspired by natural elements.



3

Versatile Installation Options

Ellipse has installation options to suit any kitchen style, from a seamless-finish undermount, to an easy-to-install topmount.



4

Always Colorful

Thanks to the UV protection, the beautiful color of the granite will not fade and ensure long-lasting use.



colors that
WOW



- ELG11022ONY Onyx \$540
- ELG11022MOC Mocha \$540
- ELG11022STO Storm \$540
- ELG11022OYS Oyster \$540
- ELG11022CHA Champagne \$540
- ELG11022SHG Stone Grey \$540
- NEW ELG11022PWT Polar White \$540

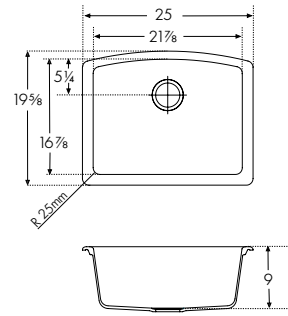

SPECIFICATIONS

Interior Dimensions: 21 7/8" x 16 7/8" x 9"
 Exterior Dimensions: 25" x 19 5/8"
 Minimum Cabinet Size: 27"
 Weight: 30 lbs.
 Corner Radius: 25mm
 Installation: Undermount

ACCESSORIES

- 4 **Bottom Grid**
ELG22-36S
- 5 **Universal Roller Mat**
UV-36RM
- 6 **Strainer Basket**
906
906SN

- ELG1200NY Onyx \$630
- ELG120MOC Mocha \$630
- ELG120STO Storm \$630
- ELG120OYS Oyster \$630
- ELG120CHA Champagne \$630
- ELG120SHG Stone Grey \$630
- NEW ELG120PWT Polar White \$630

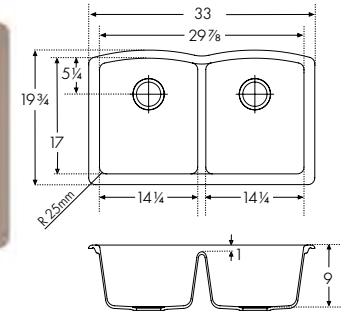

SPECIFICATIONS

Interior Dimensions: 29 3/4" x 17" x 9"
 Exterior Dimensions: 33" x 19 3/4"
 Minimum Cabinet Size: 36"
 Weight: 37 lbs.
 Corner Radius: 25mm
 Installation: Undermount

ACCESSORIES

- 2 **Bottom Grid**
ELG14-36S
- 5 **Universal Roller Mat**
UV-36RM
- 6 **Strainer Basket**
906
906SN

- ELG1600NY Onyx \$630
- ELG160MOC Mocha \$630
- ELG160STO Storm \$630
- ELG160OYS Oyster \$630
- ELG160CHA Champagne \$630
- ELG160SHG Stone Grey \$630
- NEW ELG160PWT Polar White \$630

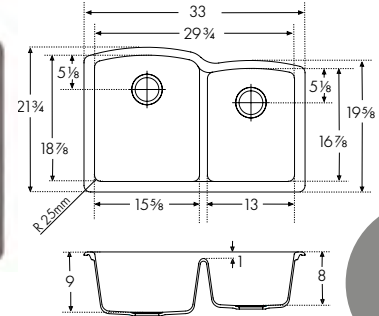

SPECIFICATIONS

Interior Dimensions: 29 3/4" x 18 7/8" x 9" & 8"
 Exterior Dimensions: 33" x 21 3/4"
 Minimum Cabinet Size: 36"
 Weight: 42 lbs.
 Corner Radius: 25mm
 Installation: Undermount

ACCESSORIES

- 3 **Bottom Grid**
ELG16-36S
- 1 **Bottom Grid**
ELG13-36S
- 5 **Universal Roller Mat**
UV-36RM
- 6 **Strainer Basket**
906
906SN

ACCESSORIES

- 1 **Bottom Grid**
10 3/4" x 14 1/4"
Stainless
ELG13-36S
\$135
- 2 **Bottom Grid**
11 3/4" x 14 1/4"
Stainless
ELG14-36S
\$150
- 3 **Bottom Grid**
13 1/8" x 16 1/8"
Stainless
ELG16-36S
\$165
- 4 **Bottom Grid**
19 1/4" x 14 1/4"
Stainless
ELG22-36S
\$165
- 5 **Universal Roller Mat**
18 7/8" x 20"
Stainless
UV-36RM
\$175
- 6 **Strainer Basket**
Chrome
906
\$70
Satin Nickel
906SN
\$95

- ESOX25229-1** (1 faucet hole; 3 predrilled) ■ Onyx \$480
- ESDB25229-1** (1 faucet hole; 3 predrilled) ■ Mocha \$480
- ESCH25229-1** (1 faucet hole; 3 predrilled) ■ Champagne \$480
- NEW ESSG25229-1** (1 faucet hole; 3 predrilled) ■ Stone Grey \$480
- NEW ESOY25229-1** (1 faucet hole; 3 predrilled) ■ Oyster \$480
- NEW ESPW25229-1** (1 faucet hole; 3 predrilled) ■ Polar White \$480

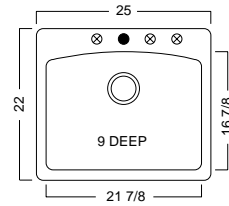

SPECIFICATIONS

Interior Dimensions: 21 7/8" x 16 7/8" x 9"
 Exterior Dimensions: 25" x 22"
 Minimum Cabinet Size: 27"
 Weight: 30 lbs.
 Corner Radius: 25mm
 Installation: Dual Mount

ACCESSORIES

- 4 Bottom Grid**
FBGG1914

- E0OX33229-1** (1 faucet hole; 3 predrilled) ■ Onyx \$540
- E0DB33229-1** (1 faucet hole; 3 predrilled) ■ Mocha \$540
- E0CH33229-1** (1 faucet hole; 3 predrilled) ■ Champagne \$540
- NEW E0SG33229-1** (1 faucet hole; 3 predrilled) ■ Stone Grey \$540
- NEW E0OY33229-1** (1 faucet hole; 3 predrilled) ■ Oyster \$540
- NEW E0PW33229-1** (1 faucet hole; 3 predrilled) ■ Polar White \$540

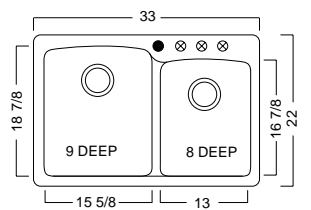

SPECIFICATIONS

Interior Dimensions: 29 3/4" x 18 7/8" x 16 7/8" x 9" & 8"
 Exterior Dimensions: 33" x 22"
 Minimum Cabinet Size: 36"
 Weight: 42 lbs.
 Corner Radius: 25mm
 Installation: Dual Mount

ACCESSORIES

- 3 Bottom Grid** FBGG1316
- 2 Bottom Grid** FBGG1014

- EDOX33229-1** (1 faucet hole; 3 predrilled) ■ Onyx \$530
- EDDB33229-1** (1 faucet hole; 3 predrilled) ■ Mocha \$530
- EDCH33229-1** (1 faucet hole; 3 predrilled) ■ Champagne \$530
- NEW ED SG33229-1** (1 faucet hole; 3 predrilled) ■ Stone Grey \$530
- NEW ED OY33229-1** (1 faucet hole; 3 predrilled) ■ Oyster \$530
- NEW ED PW33229-1** (1 faucet hole; 3 predrilled) ■ Polar White \$530

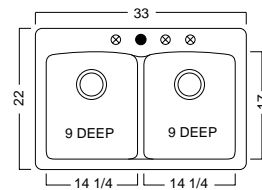





SPECIFICATIONS

Interior Dimensions: 29 7/8" x 17" x 9"
 Exterior Dimensions: 33" x 22"
 Minimum Cabinet Size: 36"
 Weight: 42 lbs.
 Corner Radius: 25mm
 Installation: Dual Mount

ACCESSORIES

- 1 Bottom Grid**
FBGG1114

ACCESSORIES

- 
1 Bottom Grid
11 1/2" x 14"
Stainless
FBGG1114
\$105
- 
2 Bottom Grid
10" x 14"
Stainless
FBGG1014
\$105
- 
3 Bottom Grid
12 3/4" x 16"
Stainless
FBGG1316
\$115
- 
4 Bottom Grid
18 3/4" x 13 3/4"
Stainless
FBGG1914
\$125



Primo

Sleek aesthetics, **plenty of prep space** and the **durability** every kitchen requires, grace the Primo sink. The deep **9" bowl** allows for easy washing of large dishes and minimize splashing.

Primo



1

Generous Bowl Capacity

The 9" deep bowl easily accommodates large cookware to tackle your biggest kitchen tasks.



2

Dual Mount Installation

Primo provides the versatility of undermount installation for an edgeless finish or topmount installation with the rim extending over the countertop.



- NEW** DIG61091-ONY ■ Onyx \$530
(1 faucet hole; 3 predrilled)
- DIG61091-GRA ■ Graphite \$530
(1 faucet hole; 3 predrilled)
- DIG61091-MOC ■ Mocha \$530
(1 faucet hole; 3 predrilled)
- DIG61091-CHA ■ Champagne \$530
(1 faucet hole; 3 predrilled)
- DIG61091-PWT ■ Polar White \$530
(1 faucet hole; 3 predrilled)
- DIG61091-SHG ■ Stone Grey \$530
(1 faucet hole; 3 predrilled)

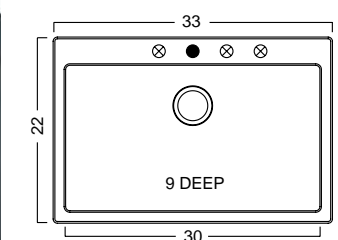

SPECIFICATIONS

Interior Dimensions: 30" x 17" x 9"
Exterior Dimensions: 33" x 22"
Minimum Cabinet Size: 36"
Weight: 36 lbs.
Corner Radius: 13mm
Installation: Dual Mount

ACCESSORIES

- 1 **Bottom Grid**
BGDI110

- NEW** DIG62D91-ONY ■ Onyx \$600
(1 faucet hole; 3 predrilled)
- DIG62D91-GRA ■ Graphite \$600
(1 faucet hole; 3 predrilled)
- DIG62D91-MOC ■ Mocha \$600
(1 faucet hole; 3 predrilled)
- DIG62D91-CHA ■ Champagne \$600
(1 faucet hole; 3 predrilled)
- DIG62D91-PWT ■ Polar White \$600
(1 faucet hole; 3 predrilled)
- DIG62D91-SHG ■ Stone Grey \$600
(1 faucet hole; 3 predrilled)

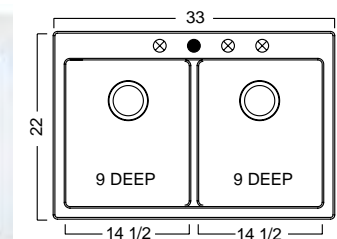

SPECIFICATIONS

Interior Dimensions: 30" x 17" x 9"
Exterior Dimensions: 33" x 22"
Minimum Cabinet Size: 36"
Weight: 42 lbs.
Corner Radius: 13mm
Installation: Dual Mount

ACCESSORIES

- 2 **Bottom Grid**
BGDI100

ACCESSORIES

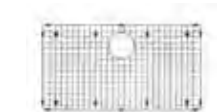

- 1 **Bottom Grid**
27⁷/₈" x 15"
Stainless
BGDI110
\$135



- 2 **Bottom Grid**
12³/₈" x 15"
Stainless
BGDI100
\$125

Gravity

The beauty of granite offsets the subtly **curved design** of Gravity to create a sink that adds an attractive element to your kitchen. **Durable and hygienic**, it's perfect for the family kitchen.



Pictured: SP3322-1 sink with FFP3450 faucet

Gravity



1

Graceful Curves

The artistry of gentle curves adds visual appeal to create a luxurious look to the most-used space in your home.



2

Dual Mount

Whether you prefer a topmount or undermount sink, Gravity offers versatility to suit your style.



SGR3322-1
(1 faucet hole; 3 predrilled)

■ Graphite \$530

SC3322-1
(1 faucet hole; 3 predrilled)

■ Champagne \$530

SP3322-1
(1 faucet hole; 3 predrilled)

■ Polar White \$530

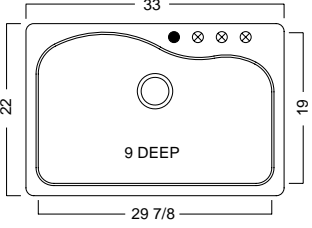

SPECIFICATIONS

Interior Dimensions: 29 7/8" x 19" x 9"
Exterior Dimensions: 33" x 22"
Minimum Cabinet Size: 36"
Weight: 34 lbs.
Corner Radius: 26mm
Installation: Dual Mount

ACCESSORIES

1 | **Bottom Grid**
FBBG2716

DIG62F91-ONY
(1 faucet hole; 3 predrilled)

■ Onyx \$580

DIG62F91-GRA
(1 faucet hole; 3 predrilled)

■ Graphite \$580

DIG62F91-MOC
(1 faucet hole; 3 predrilled)

■ Mocha \$580

DIG62F91-CHA
(1 faucet hole; 3 predrilled)

■ Champagne \$580

DIG62F91-PWT
(1 faucet hole; 3 predrilled)

■ Polar White \$580

DIG62F91-SHG
(1 faucet hole; 3 predrilled)

■ Stone Grey \$580

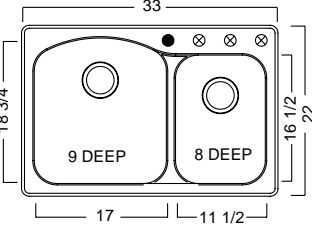

SPECIFICATIONS

Interior Dimensions: 29 3/4" x 18 3/4" x 16 1/2" x 9" & 8"
Exterior Dimensions: 33" x 22"
Minimum Cabinet Size: 36"
Weight: 42 lbs.
Corner Radius: 75mm
Installation: Dual Mount

ACCESSORIES

2 | **Bottom Grid**
BGDIS150

3 | **Bottom Grid**
BGDIL150

ACCESSORIES

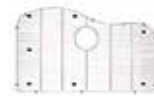

1 | **Bottom Grid**
27" x 16 1/2"
Stainless
FBBG2716
\$150



2 | **Bottom Grid**
9 1/2" x 14 1/2"
Stainless
BGDIS150
\$125



3 | **Bottom Grid**
15 7/8" x 16 1/2"
Stainless
BGDIL150
\$125

Note: All accessories sold separately unless otherwise indicated. Design of custom accessories subject to change without notice. It is absolutely critical that you have the sink and any custom sink accessories on site prior to any cut or modification to the countertop. Franke will not be responsible for any errors in countertop preparation and sink installation.

Quantum

Beautiful and durable, Quantum is the perfect bar or prep sink. Thanks to its **UV protection**, granite does not fade, ensuring that your sink will be long-lasting. Granite also offers **superior resistance to scratches** and chipping and is heat resistant.



Pictured: SZPW1720-1 sink with FF3180 faucet

Quantum

Quantum Granite



1

Exquisitely Compact

A small sink that's big on looks, Quantum brings the beauty of granite to your bar or prep area.



2

Enduring Good Looks

Scratch resistant and stain resistant, this sink will provide long-lasting use.



SOX1720-1

(1 faucet hole; 2 predrilled)

■ Onyx \$400

SZGR1720-1

(1 faucet hole; 2 predrilled)

■ Graphite \$400

SZCH1720-1

(1 faucet hole; 2 predrilled)

■ Champagne \$400

SZPW1720-1

(1 faucet hole; 2 predrilled)

■ Polar White \$400

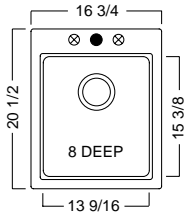

SPECIFICATIONS

Interior Dimensions: 13 7/8" x 15 3/8" x 8"
Exterior Dimensions: 16 3/4" x 20 1/2"
Minimum Cabinet Size: 18"
Weight: 22 lbs.
Corner Radius: 25mm
Installation: Dual Mount

ACCESSORIES

1 **Bottom Grid**
FBG180S

ACCESSORIES



1 **Bottom Grid**
11 7/8" x 13 5/8"
Stainless
FBG180S
\$95

Quantum Granite



Faucets

| | |
|--------------|---------|
| Farm House | 190-195 |
| Professional | 196-199 |
| Crystal | 200-201 |
| Absinthe | 202-207 |
| Pescara | 208-215 |
| Peak | 216-217 |
| Ambient | 218-223 |
| Steel | 224-229 |
| Active | 230-233 |
| Kubus | 234-235 |
| Cube | 236-239 |



Faucets

Faucets

Faucets to the highest standards

From extravagant to purist. From satin nickel to polished chrome. Whether you prefer a flexible, pull-out, or integrated water filter, the Franke faucet range meets every need in every kitchen. Your favorite Franke faucet will be the perfect match for your ideal Franke sink.

MANUFACTURING TO FINEST STANDARDS

Outstanding design and quality components come together during the Franke manufacturing process. Strict adherence to Franke manufacturing standards in forming, finishing and final assembly achieves the exceptional quality and durability that makes a Franke faucet the most desired addition to a kitchen.

WATER SAVING FEATURE

Conserve natural resources and trim your water bill with Franke's water saving feature. Move the handle to the first position for a water-saving 50% flow. Moving the handle to the second position allows for 100% flow.

Look for faucets with the water saving feature icon, as not all faucets have this feature.



QUALITY ASSURANCE AND CERTIFICATIONS

Franke faucets are manufactured under the supervision and testing of local and international certifying bodies, including CSA, IAPMO, ICC, and NSF. All Franke faucets meet the requirements of the Federal Safe Drinking Water Act, NSF372, NSF61 and ASME A112.18.1\CSA B125.





Faucet Finishes

MAKE YOUR STATEMENT

Franke offers a large selection of premium faucet finishes to complete the design statement in your well-appointed kitchen. Complement or contrast your sink or appliances with one of **16 available** finishes from Matte Black for a sophisticated, modern appeal, to earthy Bronze or rich, bold Copper to accent cabinetry and countertops.





Farm House

Farm House faucets bring country charm to sinks and kitchens of any design. Choose among **Polished Chrome** and **Satin Nickel finishes** to reflect your personal style.



Pictured: FF7000A faucet

FF6000A

Limited Quantities Available

- FF6000A Polished Chrome \$1,755
- FF6080A Satin Nickel \$1,960

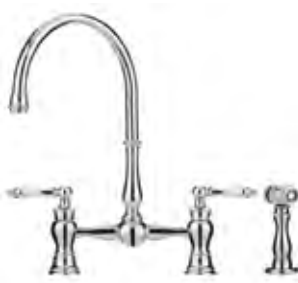

FEATURES AND BENEFITS

3-Hole Bridge Faucet with Side Spray
 Flow Rate: 1.75 gpm
 Spray Function: Press & Hold
 Spray Type: Spray & Stream
 Spout Swivel Range: 180°
 Cartridge: 1/2" Ceramic
 Countertop Hole Diameter: 1 3/8"
 Weight: 14 lbs.
 ADA Compliant

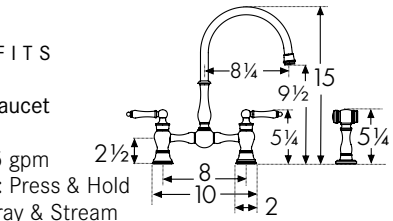

FFPD400

Limited Quantities Available

- FFPD400 Polished Chrome \$870
- FFPD480 Satin Nickel \$1,015



FEATURES AND BENEFITS

1-Hole Pull-Down
 Flow Rate: 1.75 gpm
 Spray Function: Toggle
 Spray Type: Spray & Stream
 Spout Swivel Range: 360°
 Cartridge: 35mm Ceramic
 Countertop Hole Diameter: 1 3/8"
 Weight: 10 lbs.
 ADA Compliant

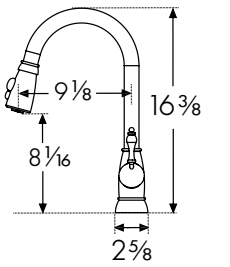

FF7000A

Limited Quantities Available

- FF7000A Polished Chrome \$1,755
- FF7080A Satin Nickel \$1,960



FEATURES AND BENEFITS

3-Hole Bridge Faucet with Side Spray
 Flow Rate: 1.75 gpm
 Spray Function: Press & Hold
 Spray Type: Spray & Stream
 Spout Swivel Range: 180°
 Cartridge: 1/2" Ceramic
 Countertop Hole Diameter: 1 3/8"
 Weight: 15 lbs.
 ADA Compliant

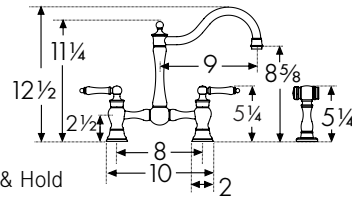

PF7000A

Limited Quantities Available

- PF7000A Polished Chrome \$910
- PF7080A Satin Nickel \$1,015



FEATURES AND BENEFITS

Wall Mount Pot Filler
 Flow Rate: 2.2 gpm
 Spout Swivel Range: 180°
 Cartridge: 1/2" Ceramic
 Weight: 5 lbs.
 ADA Compliant

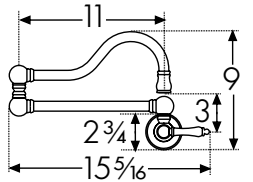

FFS100

Limited Quantities Available

- FFS100 Polished Chrome \$1,015
- FFS180 Satin Nickel \$1,130



FEATURES AND BENEFITS

1-Hole with Side Spray
 Flow Rate: 1.75 gpm
 Spray Function: Press & Hold
 Spray Type: Spray & Stream
 Spout Swivel Range: 180°
 Cartridge: 3/8" Ceramic
 Countertop Hole Diameter: 1 3/8"
 Weight: 9 lbs.
 ADA Compliant

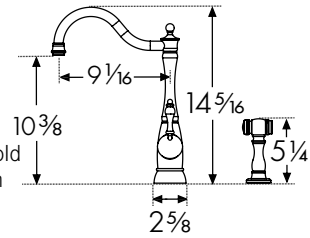

PF3300

Limited Quantities Available

- PF3300 Polished Chrome \$710
- PF3380 Satin Nickel \$820



FEATURES AND BENEFITS

Wall Mount Pot Filler
 Flow Rate: 2.2 gpm
 Spout Swivel Range: 180°
 Cartridge: 1/2" Ceramic
 Weight: 5 lbs.
 ADA Compliant

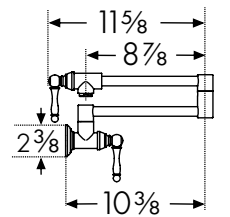

FFS400

Limited Quantities Available

- FFS400 Polished Chrome \$1,015
- FFS480 Satin Nickel \$1,130



FEATURES AND BENEFITS

1-Hole with Side Spray
 Flow Rate: 1.75 gpm
 Spray Function: Press & Hold
 Spray Type: Spray & Stream
 Spout Swivel Range: 180°
 Cartridge: 1/2" Ceramic
 Countertop Hole Diameter: 1 3/8"
 Weight: 11 lbs.
 ADA Compliant

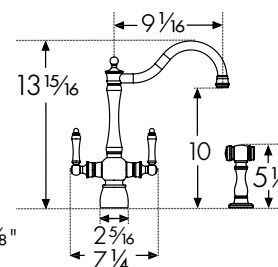

DW6100C

Limited Quantities Available

- DW6100C Polished Chrome \$435
- DW6180C Satin Nickel \$525



FEATURES AND BENEFITS

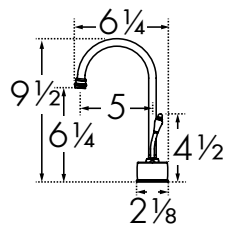

The Little Butler® Cold Filtered
 Flow Rate: 0.5 gpm
 Spray Type: Stream
 Spout Swivel Range: 360°
 Cartridge: 3/8" Ceramic
 Countertop Hole Diameter: 1 3/8"
 Weight: 3 lbs.
 ADA Compliant



Indicates: Cold Hot Hot/Cold

LB6100C

Limited Quantities Available

- LB6100C  Polished Chrome \$435
- LB6180C  Satin Nickel \$525



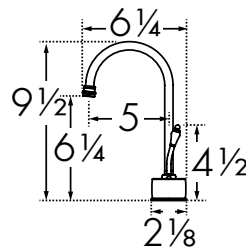

FEATURES AND BENEFITS

The Little Butler® Hot Filtered
 Flow Rate: 0.5 gpm
 Spray Type: Stream
 Spout Swivel Range: 360°
 Cartridge: 3/8" Ceramic
 Countertop Hole Diameter: 1 3/8"
 Weight: 3 lbs.
 ADA Compliant 



LB12200

Limited Quantities Available

- LB12200  Polished Chrome \$580
- LB12280  Satin Nickel \$700



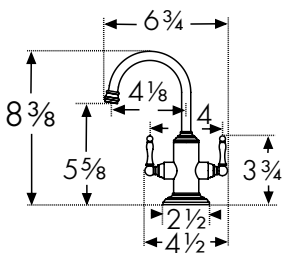

FEATURES AND BENEFITS

The Little Butler® Hot/Cold Filtered
 Flow Rate: 0.5 gpm
 Spray Type: Stream
 Spout Swivel Range: 360°
 Cartridge: 3/8" Ceramic
 Countertop Hole Diameter: 1 1/4"
 Weight: 4 lbs.
 ADA Compliant 



LB6200C

Limited Quantities Available

- LB6200C  Polished Chrome \$600
- LB6280C  Satin Nickel \$720



FEATURES AND BENEFITS

The Little Butler® Hot/Cold Filtered
 Flow Rate: 0.5 gpm
 Spray Type: Stream
 Spout Swivel Range: 360°
 Cartridge: 3/8" Ceramic
 Countertop Hole Diameter: 1 3/8"
 Weight: 3 lbs.
 ADA Compliant 

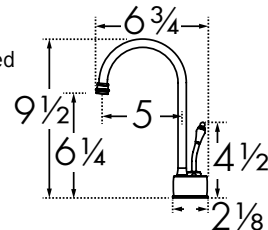

SD6000

Limited Quantities Available

- SD6000  Polished Chrome \$200
- SD6080  Satin Nickel \$230



FEATURES AND BENEFITS

Hole Size: 1 1/8"
 Weight: 1 lb.
 Capacity: 12 oz.

Dispenser Head Detail

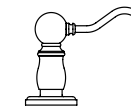

Farm House Dispenser

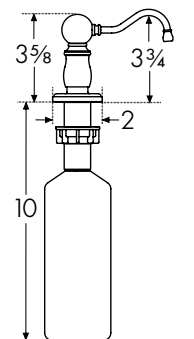

DW12000

Limited Quantities Available

- DW12000  Polished Chrome \$460
- DW12080  Satin Nickel \$540



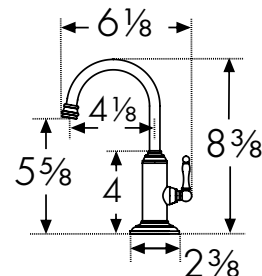

FEATURES AND BENEFITS

The Little Butler® Cold Filtered
 Flow Rate: 0.5 gpm
 Spray Type: Stream
 Spout Swivel Range: 360°
 Cartridge: 3/8" Ceramic
 Countertop Hole Diameter: 1 1/4"
 Weight: 2 lbs.
 ADA Compliant 



LB12100

Limited Quantities Available

- LB12100  Polished Chrome \$460
- LB12180  Satin Nickel \$540



FEATURES AND BENEFITS

The Little Butler® Hot Filtered
 Flow Rate: 0.5 gpm
 Spray Type: Stream
 Spout Swivel Range: 360°
 Cartridge: 3/8" Ceramic
 Countertop Hole Diameter: 1 1/4"
 Weight: 3 lbs.
 ADA Compliant 

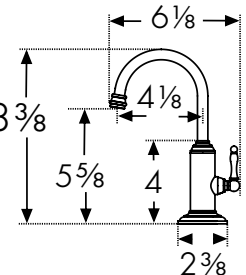

Indicates:  Cold  Hot  Hot/Cold

Indicates:  Cold  Hot  Hot/Cold



Pictured: FFPD5400 faucet

Professional

Professional faucets are available in **three configurations** to fit your workstyle and your design preference. All feature a **360-degree swivel spout** for a powerful, directional spray. Pair your new faucet with one of **Franke's Professional** series sinks for a kitchen that not only works hard but will also add beauty to your home. The filter spout model offers the convenience of **clean water** for cooking and drinking right from the faucet.



Professional



1

Full Coverage Swivel

The 360 degree swivel spout generates a full range of motion, allowing you the flexibility to reach almost any area of your sink, and the tall arch design offers exceptional space for cleaning or filling large pots and pans.



2

Pre-Rinse Spray

Dual functionality, toggle between spray and stream to make rinsing vegetables or cleaning food residue effortless.



FFPD5400

FFPD5400 Polished Chrome \$1,285
FFPD5480 Satin Nickel \$1,525



FEATURES AND BENEFITS

1-Hole Semi-Pro & 3 in 1 Hot/Cold/Filtered Cold
Pre-Rinse Spout: Spray + Stream
Filling Spout: Cold filtered
Flow Rate: 1.75 gpm & .5 gpm
Spray Function: Press & Hold
Spray Type: Spray & Stream
Spout Swivel Range: 360°
Cartridge: 35mm Ceramic
Countertop Hole Diameter: 1 3/8"
Weight: 12 lbs.
ADA Compliant

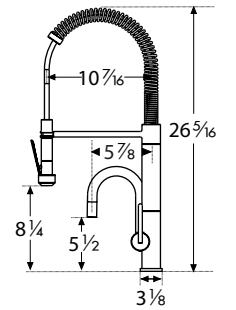

Note: Filter is not included. Please reference pages 249-253 for filtration options.

FFPD5300

FFPD5300 Polished Chrome \$1,160
FFPD5380 Satin Nickel \$1,400



FEATURES AND BENEFITS

1-Hole Semi-Pro
Pre-Rinse Spout: Spray Only
Filling Spout: Stream Only
Flow Rate: 1.75 gpm
Spray Function: Press & Hold
Spray Type: Spray & Stream
Spout Swivel Range: 360°
Cartridge: 35mm Ceramic
Countertop Hole Diameter: 1 3/8"
Weight: 11 lbs.
ADA Compliant

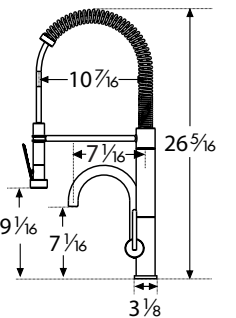

FF5300

FF5300 Polished Chrome \$775
FF5380 Satin Nickel \$930



FEATURES AND BENEFITS



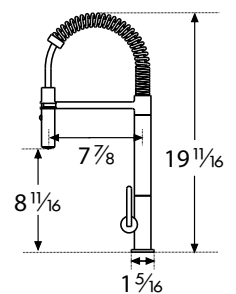

1-Hole Semi-Pro Pull-Down
Flow Rate: 1.75 gpm
Spray Function: Toggle
Spray Type: Spray & Stream
Spout Swivel Range: 360°
Cartridge: 35mm Ceramic
Countertop Hole Diameter: 1 3/8"
Weight: 8 lbs.
ADA Compliant



Indicates: Cold Hot Hot/Cold

ADA Compliant: Product is compliant with the American Disabilities Act when properly installed.
Faucet supply lines are U.S. standard 3/8" O.D. All faucets can accommodate at least 1 3/4" countertop thickness. Several can accommodate up to 3". Call for additional thickness.

FFPD4600

- FFPD4600  Polished Chrome \$1,235
- FFPD4611  Chrome with White Glass \$1,345
- FFPD4621  Chrome with Black Glass \$1,345
- FFPD4680  Satin Nickel \$1,455



FEATURES AND BENEFITS

- 1-Hole Semi-Pro
- Flow Rate: 1.75 gpm
- Spray Function: Toggle
- Spray Type: Spray & Stream
- Spout Swivel Range: 360°
- Cartridge: 35mm Ceramic
- Countertop Hole Diameter: 1 3/8"
- Weight: 11 lbs.
- Magnetic Spray Dock
- ADA Compliant 

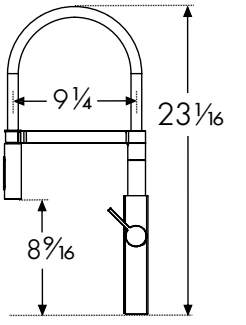



Pictured: FFPD4611 faucet

Crystal

Crystal faucets beautifully complement the sinks in our Crystal Collection. They make a **bold statement** – and offer extraordinary function – when paired with any Franke sink.

Crystal Dispenser

SD2600

- SD2600  Polished Chrome \$205
- SD2680  Satin Nickel \$240



FEATURES AND BENEFITS

- Hole Size: 1 1/8"
- Weight: 1 lb.
- Capacity: 8.5 oz.

Dispenser Head Detail

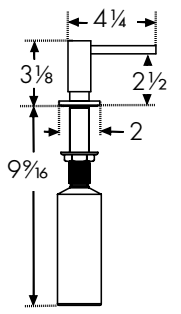
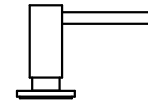







Pictured: FF5200 faucet, LB15200 filtration faucet and SD5200 soap dispenser

Absinthe

Beauty across the entire range. Oriented on current trends in product design, the combination of the **urban style** and sculptured form provide **sleek aesthetics** that will delight the culinary artist day after day.



FFS5200

- FFS5200**  Polished Chrome **\$795**
- FFS5220**  Matte Black **\$950**
- FFS5280**  Satin Nickel **\$950**
- NEW** **FFS5290SB**  Satin Brass **\$950**





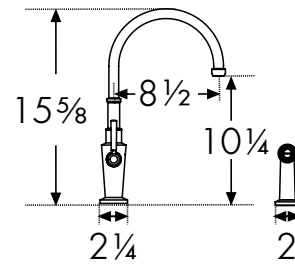

FEATURES AND BENEFITS

1-Hole Faucet with Side Spray
 Flow Rate: 1.75 gpm
 Spray Function: Press & Hold
 Spray Type: Spray & Stream
 Spout Swivel Range: 360°
 Cartridge: 1/2" Ceramic
 Countertop Hole Diameter: 1 3/8"
 Weight: 10 lbs.
 ADA Compliant 



FFP5200

- FFP5200**  Polished Chrome **\$640**
- FFP5220**  Matte Black **\$780**
- FFP5280**  Satin Nickel **\$780**
- NEW** **FFP5290SB**  Satin Brass **\$780**





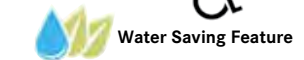
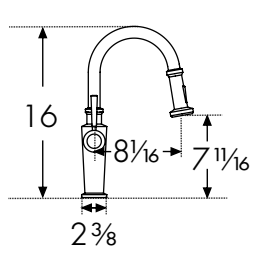

FEATURES AND BENEFITS

1-Hole Prep
 Flow Rate: 1.75 gpm
 Spray Function: Toggle
 Spray Type: Spray & Stream
 Spout Swivel Range: 180°
 Cartridge: 35mm Ceramic
 Countertop Hole Diameter: 1 3/8"
 Weight: 11 lbs.
 Magnetic Spray Dock
 ADA Compliant 



FF5200

- FF5200**  Polished Chrome **\$675**
- FF5220**  Matte Black **\$825**
- FF5280**  Satin Nickel **\$825**
- NEW** **FF5290SB**  Satin Brass **\$825**





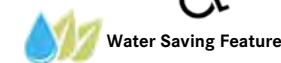
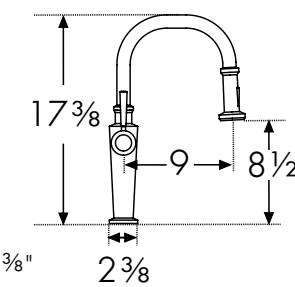

FEATURES AND BENEFITS

1-Hole Pull-Down
 Flow Rate: 1.75 gpm
 Spray Function: Toggle
 Spray Type: Spray & Stream
 Spout Swivel Range: 180°
 Cartridge: 35mm Ceramic
 Countertop Hole Diameter: 1 3/8"
 Weight: 11 lbs.
 Magnetic Spray Dock
 ADA Compliant 



FFB5200

- FFB5200**  Polished Chrome **\$485**
- FFB5220**  Matte Black **\$595**
- FFB5280**  Satin Nickel **\$595**
- NEW** **FFB5290SB**  Satin Brass **\$595**





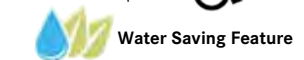
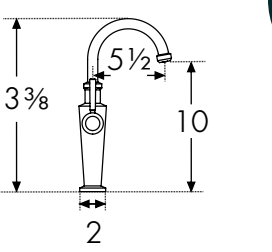

FEATURES AND BENEFITS

1-Hole Bar
 Flow Rate: 1.75 gpm
 Spray Type: Stream
 Spout Swivel Range: 360°
 Cartridge: 28mm Ceramic
 Countertop Hole Diameter: 1 3/8"
 Weight: 6 lbs.
 ADA Compliant 



FFPS5200

- FFPS5200**  Polished Chrome **\$675**
- FFPS5220**  Matte Black **\$825**
- FFPS5280**  Satin Nickel **\$825**
- NEW** **FFPS5290SB**  Satin Brass **\$825**



FEATURES AND BENEFITS

1-Hole Pull-Out
 Flow Rate: 1.75 gpm
 Spray Function: Toggle
 Spray Type: Spray & Stream
 Spout Swivel Range: 180°
 Cartridge: 35mm Ceramic
 Countertop Hole Diameter: 1 3/8"
 Weight: 9 lbs.

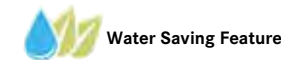
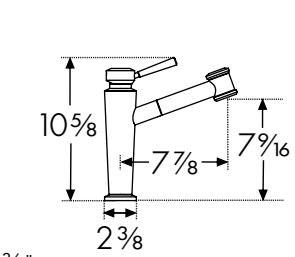

FFT5200

- FFT5200**  Polished Chrome **\$640**
- FFT5220**  Matte Black **\$780**
- FFT5280**  Satin Nickel **\$780**





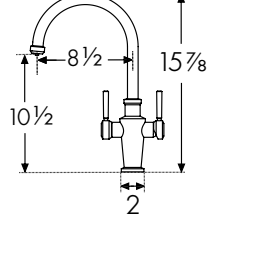

FEATURES AND BENEFITS

3 in 1 Hot/Cold/Filtered Cold
 Flow Rate: 1.75 gpm/0.5 gpm
 Spray Type: Stream
 Spout Swivel Range: 360°
 Cartridge: 28mm Ceramic
 Countertop Hole Diameter: 1 3/8"
 Weight: 10 lbs.
 ADA Compliant 



Note: Filter is not included. Please reference pages 249-253 for filtration options.

PF5200

- PF5200**  Polished Chrome **\$675**
- PF5220**  Matte Black **\$825**
- PF5280**  Satin Nickel **\$825**
- NEW** **PF5290SB**  Satin Brass **\$825**



FEATURES AND BENEFITS

Wall Mount Pot Filler
 Flow Rate: 2.2 gpm
 Spout Swivel Range: 180°
 Cartridge: 1/2" Ceramic
 Weight: 6 lbs.
 ADA Compliant 

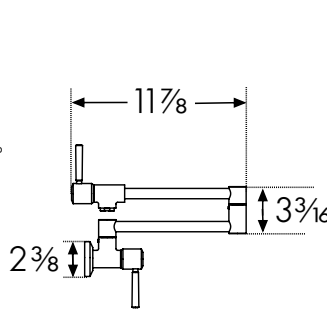

DW15000

- DW15000**  Polished Chrome **\$475**
- DW15020**  Matte Black **\$555**
- DW15080**  Satin Nickel **\$555**
- NEW** **DW15090**  Satin Brass **\$555**



FEATURES AND BENEFITS

The Little Butler® Cold Filtered
 Flow Rate: 0.5
 Spray Type: Stream
 Spout Swivel Range: 360°
 Cartridge: 3/8" Ceramic
 Countertop Hole Diameter: 1 1/4"
 Weight: 3 lbs.
 ADA Compliant 

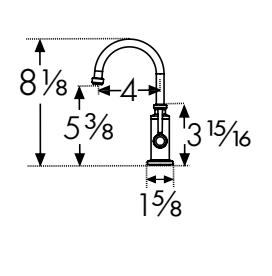

Absinthe

LB15100

- LB15100 Polished Chrome \$475
- LB15120 Matte Black \$555
- LB15180 Satin Nickel \$555
- NEW LB15190 Satin Brass \$555



FEATURES AND BENEFITS

The Little Butler® Hot Filtered
 Flow Rate: 0.5
 Spray Type: Stream
 Spout Swivel Range: 360°
 Cartridge: 3/8" Ceramic
 Countertop Hole Diameter: 1 1/4"
 Weight: 3 lbs.
 ADA Compliant

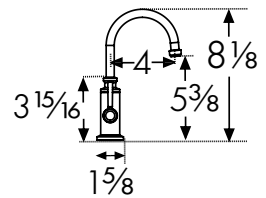

LB15200

- LB15200 Polished Chrome \$580
- LB15220 Matte Black \$700
- LB15280 Satin Nickel \$700
- NEW LB15290 Satin Brass \$700



FEATURES AND BENEFITS

The Little Butler® Hot/Cold Filtered
 Flow Rate: 0.5
 Spray Type: Stream
 Spout Swivel Range: 360°
 Cartridge: 3/8" Ceramic
 Countertop Hole Diameter: 1 1/4"
 Weight: 3 lbs.
 ADA Compliant

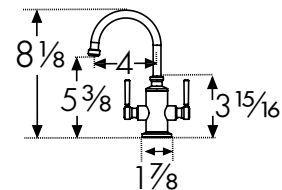

Absinthe Dispenser

SD5200

- SD5200 Polished Chrome \$150
- SD5220 Matte Black \$185
- SD5280 Satin Nickel \$185
- NEW SD5290SB Satin Brass \$185



FEATURES AND BENEFITS

Hole Size: 1 1/8"
 Weight: 1 lb.
 Capacity: 10 oz.

Dispenser Head Detail

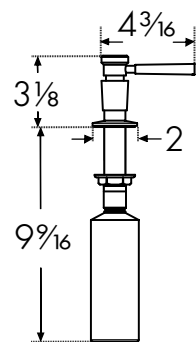
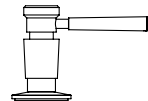

Indicates: Cold Hot Hot/Cold

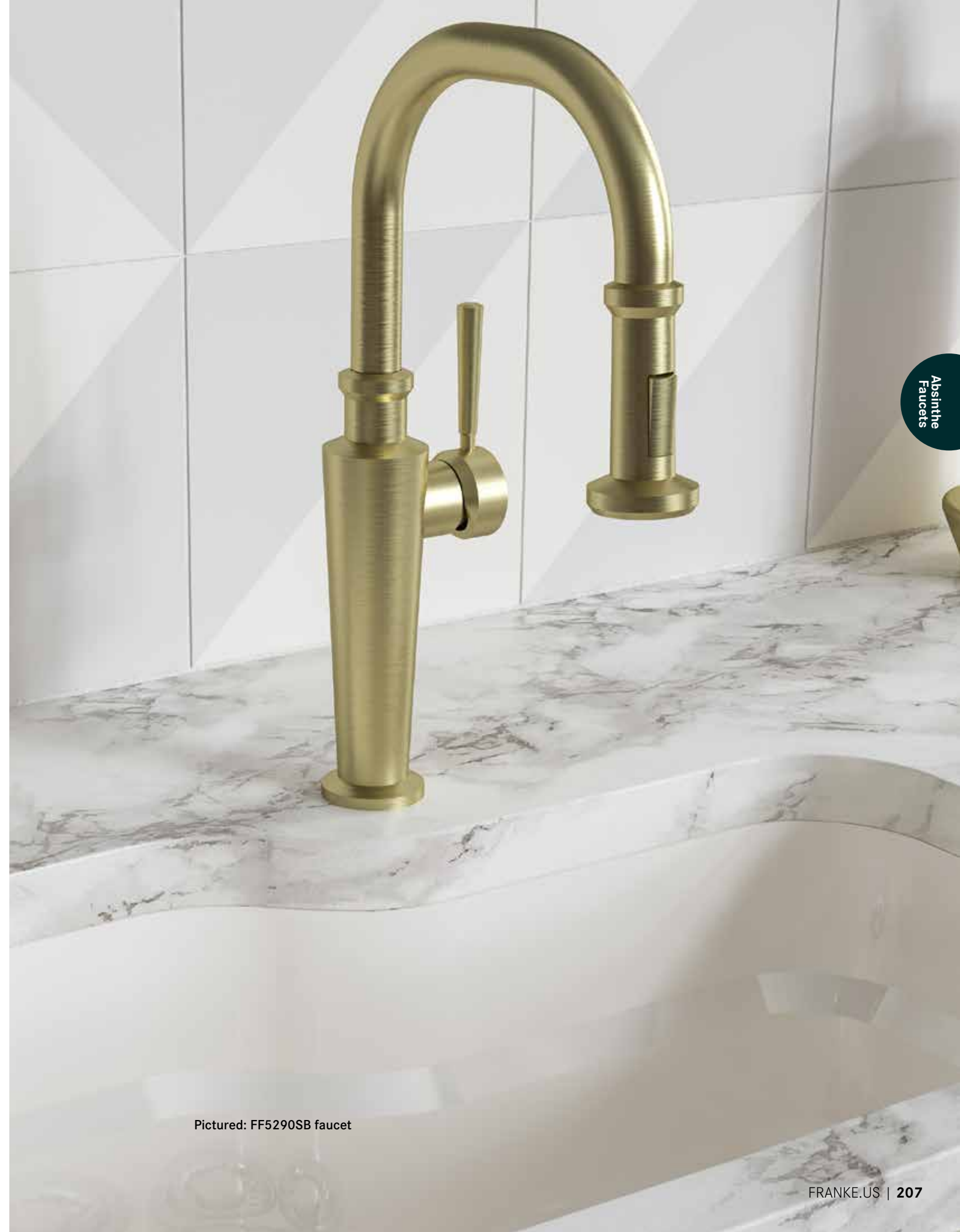

Pictured: FF5290SB faucet



Pescara

With a sleek, modern design, Pescara adds professional flair and maximum function to the home kitchen. It features a **single-lever handle** and pull-down sprayer that fits comfortably in your hand for effortless operation. Intuitive, **ergonomic design** allows easy toggling between spray and stream.

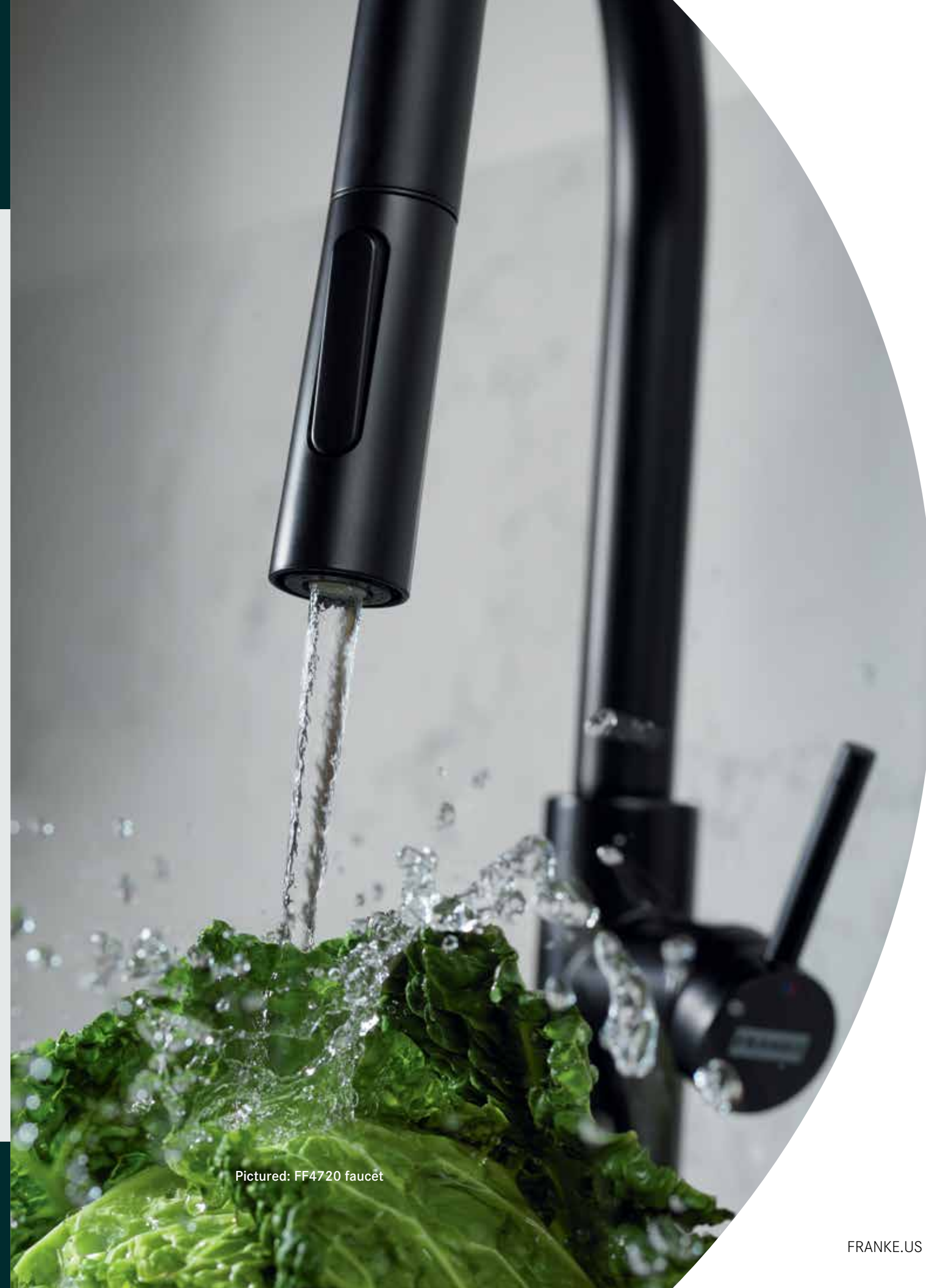

Pictured: FF4720 faucet

Pescara

1

Dual Function Spray Head

Easily toggle between spray and stream without the need to reduce water pressure between modes.



2

Durable Coil Spring Hose

The coil spring hose provides great flexibility for complete reach of the entire sink.



3

Magnetic Docking

An intuitive, quick release, magnetic dock holds the spray head securely in place when not in use.



4

Full Coverage Swivel



The 360 degree swivel spout generates a full range of motion, allowing you the flexibility to reach almost any area of your sink. The tall arch design offers exceptional space for cleaning or filling large pots and pans.

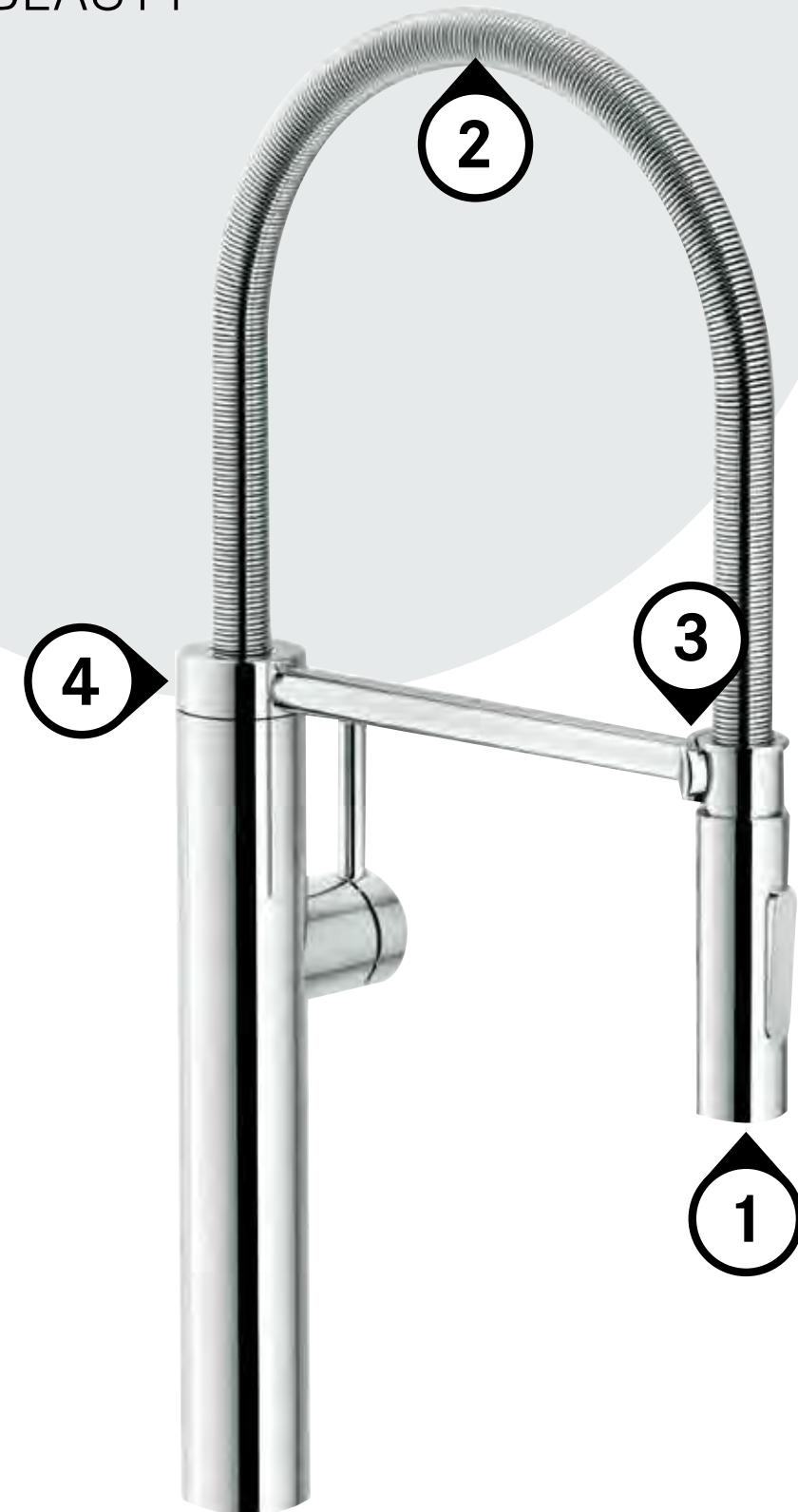

a natural
BEAUTY



FFPD4300

- FFPD4300  Polished Chrome \$795
- FFPD4350  Stainless Steel \$935



FEATURES AND BENEFITS

1-Hole Semi-Pro
 Flow Rate: 1.75 gpm
 Spray Function: Toggle
 Spray Type: Spray & Stream
 Spout Swivel Range: 360°
 Cartridge: 35mm Ceramic
 Countertop Hole Diameter: 1 3/8"
 Weight: 10 lbs.
 Magnetic Spray Dock
 ADA Compliant 

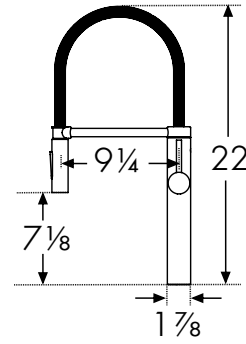

FF4700

- FF4700  Polished Chrome \$615
- FF4720  Matte Black \$725
- FF4780  Satin Nickel \$725



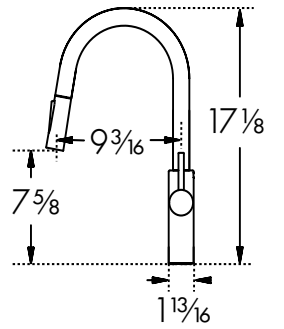

FEATURES AND BENEFITS

1-Hole Pull-Down
 Flow Rate: 1.75 gpm
 Spray Function: Toggle
 Spray Type: Spray & Stream
 Spout Swivel Range: 180°
 Cartridge: 35mm Ceramic
 Countertop Hole Diameter: 1 3/8"
 Weight: 6 lbs.
 ADA Compliant 



FFPD4400

- FFPD4400  Polished Chrome \$660
- FFPD4450  Stainless Steel \$805



FEATURES AND BENEFITS

1-Hole Semi-Pro
 Flow Rate: 1.75 gpm
 Spray Function: Toggle
 Spray Type: Spray & Stream
 Spout Swivel Range: 360°
 Cartridge: 25mm Ceramic (FFPD4450)
 28mm Ceramic (FFPD4400)
 Countertop Hole Diameter: 1 3/8"
 Weight: 8 lbs.
 Magnetic Spray Dock
 ADA Compliant 

 Water Saving Feature (FFPD4400 only)

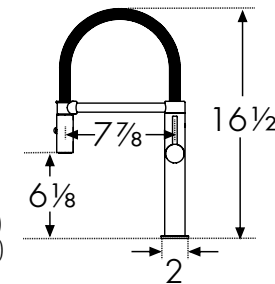



FFP4400

- FFP4400  Polished Chrome \$450
- FFP4480  Satin Nickel \$560



FEATURES AND BENEFITS

1-Hole Prep
 Flow Rate: 1.75 gpm
 Spray Type: Stream
 Spout Swivel Range: 360°
 Cartridge: 28mm Ceramic
 Countertop Hole Diameter: 1 3/8"
 Weight: 7 lbs.
 ADA Compliant 

 Water Saving Feature

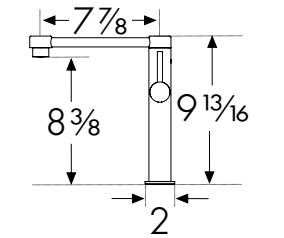

FF4400

- FF4400  Polished Chrome \$645
- FF4420  Matte Black \$775
- FF4480  Satin Nickel \$775



Extended View

FEATURES AND BENEFITS

1-Hole Semi-Pro
 Flow Rate: 1.75 gpm
 Spray Function: Press & Hold
 Spray Type: Spray & Stream
 Spout Swivel Range: 360°
 Cartridge: 28mm Ceramic
 Countertop Hole Diameter: 1 3/8"
 Weight: 8 lbs.
 Magnetic Spray Dock
 ADA Compliant 

 Water Saving Feature

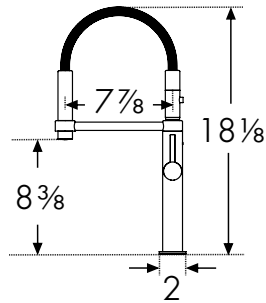



PFD4400

- PFD4400  Polished Chrome \$645
- PFD4480  Satin Nickel \$675



FEATURES AND BENEFITS

Deck Mount Pot Filler
 Flow Rate: 1.75 gpm
 Spout Swivel Range: 360°
 Cartridge: 28mm Ceramic
 Countertop Hole Diameter: 1 3/8"
 Weight: 8 lbs.
 ADA Compliant 

 Water Saving Feature

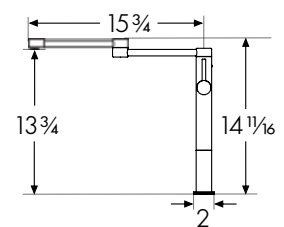

FF4800

- FF4800  Polished Chrome \$645
- FF4880  Satin Nickel \$775



FEATURES AND BENEFITS

1-Hole Pull-Down
 Flow Rate: 1.75 gpm
 Spray Function: Toggle
 Spray Type: Spray & Stream
 Spout Swivel Range: 180°
 Cartridge: 35mm Ceramic
 Countertop Hole Diameter: 1 3/8"
 Weight: 7 lbs.
 ADA Compliant 

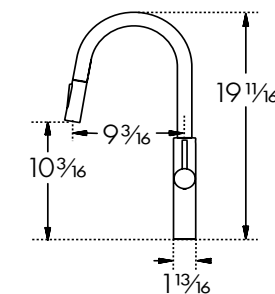

PF4400

- PF4400  Polished Chrome \$645
- PF4480  Satin Nickel \$775



FEATURES AND BENEFITS

Wall Mount Pot Filler
 Flow Rate: 2.2 gpm
 Spout Swivel Range: 180°
 Cartridge: 1/2" Ceramic
 Weight: 6 lbs.
 ADA Compliant 

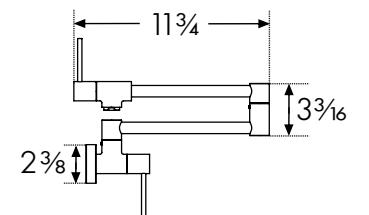

DW16000

| | | | |
|---------|---|-----------------|-------|
| DW16000 |  | Polished Chrome | \$460 |
| DW16020 |  | Matte Black | \$540 |
| DW16022 |  | Shiny Black | \$540 |
| DW16040 |  | Gun Metal | \$540 |
| DW16061 |  | Copper | \$540 |
| DW16065 |  | Bronze | \$540 |
| DW16080 |  | Satin Nickel | \$540 |
| DW16090 |  | Satin Brass | \$540 |



FEATURES AND BENEFITS

The Little Butler® Cold Filtered
 Flow Rate: 0.5
 Spray Type: Stream
 Spout Swivel Range: 360°
 Cartridge: 3/8" Ceramic
 Countertop Hole Diameter: 1 1/4"
 Weight: 3 lbs.
 ADA Compliant 

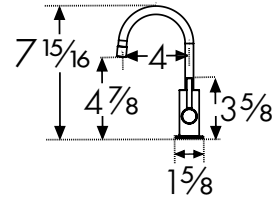

LB16100

| | | | |
|---------|---|-----------------|-------|
| LB16100 |  | Polished Chrome | \$460 |
| LB16120 |  | Matte Black | \$540 |
| LB16122 |  | Shiny Black | \$540 |
| LB16140 |  | Gun Metal | \$540 |
| LB16161 |  | Copper | \$540 |
| LB16165 |  | Bronze | \$540 |
| LB16180 |  | Satin Nickel | \$540 |
| LB16190 |  | Satin Brass | \$540 |



FEATURES AND BENEFITS

The Little Butler® Hot Filtered
 Flow Rate: 0.5
 Spray Type: Stream
 Spout Swivel Range: 360°
 Cartridge: 3/8" Ceramic
 Countertop Hole Diameter: 1 1/4"
 Weight: 3 lbs.
 ADA Compliant 

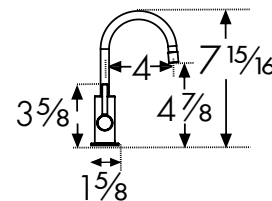

LB16200

| | | | |
|---------|---|-----------------|-------|
| LB16200 |  | Polished Chrome | \$580 |
| LB16220 |  | Matte Black | \$700 |
| LB16222 |  | Shiny Black | \$700 |
| LB16240 |  | Gun Metal | \$700 |
| LB16261 |  | Copper | \$700 |
| LB16265 |  | Bronze | \$700 |
| LB16280 |  | Satin Nickel | \$700 |
| LB16290 |  | Satin Brass | \$700 |



FEATURES AND BENEFITS

The Little Butler® Hot/Cold Filtered
 Flow Rate: 0.5
 Spray Type: Stream
 Spout Swivel Range: 360°
 Cartridge: 3/8" Ceramic
 Countertop Hole Diameter: 1 1/4"
 Weight: 3 lbs.
 ADA Compliant 

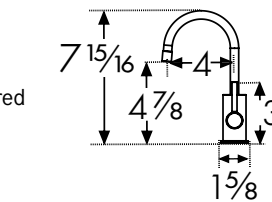

Indicates:  Cold  Hot  Hot/Cold

ADA Compliant: Product is compliant with the American Disabilities Act when properly installed.
 Faucet supply lines are U.S. standard 3/8" O.D. All faucets can accommodate at least 1 3/4" countertop thickness. Several can accommodate up to 3". Call for additional thickness.



Pictured: PFD4400 faucet

Peak



The **clean lines** and **metropolitan elegance** of the Peak faucet demonstrate that design and function can hold equal status in your kitchen. Pair this **semi-pro pull-down faucet** with a Peak granite or stainless steel sink for a kitchen that works and looks the way you want it to.



Pictured: FFPD5550 faucet

FFPD5550

FFPD5550  Stainless Steel \$760



FEATURES AND BENEFITS

- 1-Hole Semi-Pro
- Flow Rate: 1.75 gpm
- Spray Function: Toggle
- Spray Type: Spray & Stream
- Spout Swivel Range: 360°
- Cartridge: 35mm Ceramic
- Countertop Hole Diameter: 1 3/8"
- Weight: 8 lbs.
- ADA Compliant 

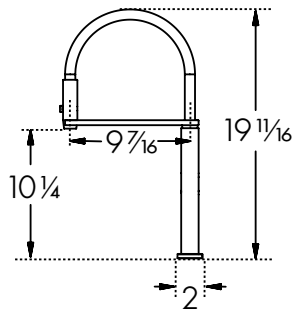



Pictured: FF3120MBK faucet

Ambient

Ambient faucets encompass all of your kitchen needs with **pull-down** and **pull-out** styles for ultimate flexibility. Enhance your workspace with the collection's **filtration faucets** and **pot filler** to have all of the functions you need – in a beautifully coordinated style.



FF3100

- FF3100 Polished Chrome \$615
- NEW** FF3120MBK Matte Black \$725
- FF3180 Satin Nickel \$725



FEATURES AND BENEFITS

1-Hole Pull-Down
 Flow Rate: 1.75 gpm
 Spray Function: Toggle
 Spray Type: Spray & Stream
 Spout Swivel Range: 180°
 Cartridge: 28mm Ceramic
 Countertop Hole Diameter: 1 3/8"
 Weight: 6 lbs.
 Magnetic Spray Dock
 ADA Compliant

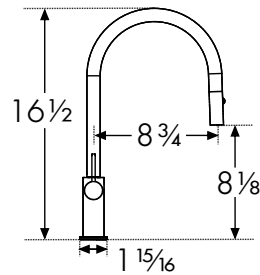
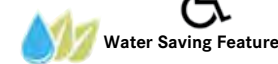

FFPS3600

- FFPS3600 Polished Chrome \$465
- FFPS3680 Satin Nickel \$580



FEATURES AND BENEFITS

1-Hole Pull-Out
 Flow Rate: 1.75 gpm
 Spray Function: Toggle
 Spray Type: Spray & Stream
 Spout Swivel Range: 110°
 Cartridge: 35mm Ceramic
 Countertop Hole Diameter: 1 3/8" 1 1/16"
 Weight: 6 lbs.
 ADA Compliant

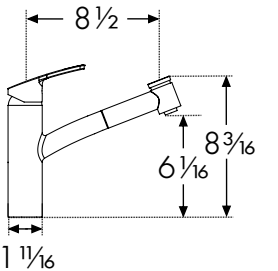

FFP3100

- FFP3100 Polished Chrome \$580
- NEW** FFP3120MBK Matte Black \$690
- FFP3180 Satin Nickel \$690



FEATURES AND BENEFITS

1-Hole Pull-Down Prep
 Flow Rate: 1.75 gpm
 Spray Function: Toggle
 Spray Type: Spray & Stream
 Spout Swivel Range: 180°
 Cartridge: 28mm Ceramic
 Countertop Hole Diameter: 1 3/8"
 Weight: 6 lbs.
 ADA Compliant

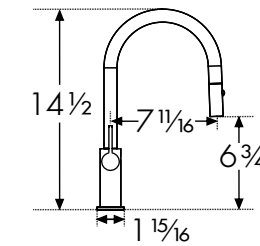
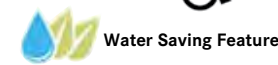

PF3100

- PF3100 Polished Chrome \$615
- NEW** PF3120MBK Matte Black \$725
- PF3180 Satin Nickel \$725



FEATURES AND BENEFITS

Wall Mount Pot Filler
 Flow Rate: 2.2 gpm
 Spout Swivel Range: 180°
 Cartridge: 1/2" Ceramic
 Weight: 5 lbs.
 ADA Compliant

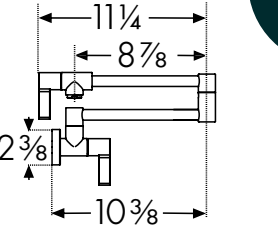

FFPS4300

- FFPS4300 Polished Chrome \$455
- FFPS4320 Matte Black \$540
- FFPS4380 Satin Nickel \$540
- FFPS4395 Brushed Gold \$540



FEATURES AND BENEFITS

1-Hole Pull-Out
 Flow Rate: 1.75 gpm
 Spray Function: Toggle
 Spray Type: Spray & Stream
 Spout Swivel Range: 110°
 Cartridge: 35mm Ceramic
 Countertop Hole Diameter: 1 3/8"
 Weight: 6 lbs.
 ADA Compliant

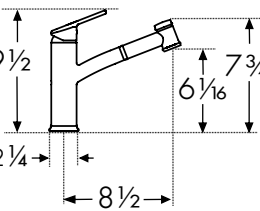

FFT3100

- FFT3100 Polished Chrome \$580
- FFT3180 Satin Nickel \$690



FEATURES AND BENEFITS

3 in 1 Hot/Cold/Filtered Cold
 Flow Rate: 1.75 gpm/0.5 gpm
 Spray Type: Stream
 Spout Swivel Range: 360°
 Cartridge: 28mm Ceramic
 Countertop Hole Diameter: 1 3/8"
 Weight: 6 lbs.
 ADA Compliant

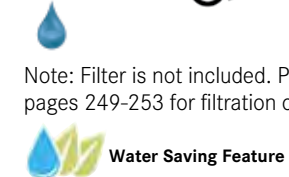

Note: Filter is not included. Please reference pages 249-253 for filtration options.

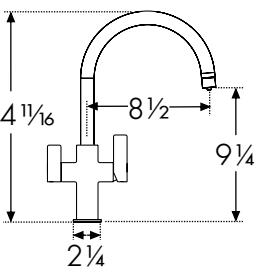

FFB3100

- FFB3100 Polished Chrome \$410
- NEW** FFB3120MBK Matte Black \$520
- FFB3180 Satin Nickel \$520



FEATURES AND BENEFITS

1-Hole Bar
 Flow Rate: 1.75 gpm
 Spray Type: Stream
 Spout Swivel Range: 360°
 Cartridge: 28mm Ceramic
 Countertop Hole Diameter: 1 3/8"
 Weight: 5 lbs.
 ADA Compliant

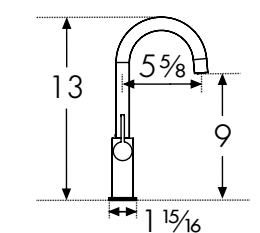
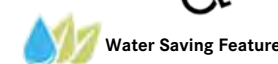

DW7000C

- DW7000C Polished Chrome \$435
- NEW** DW7020C Matte Black \$525
- DW7080C Satin Nickel \$525



FEATURES AND BENEFITS

The Little Butler® Cold Filtered
 Flow Rate: 0.5 gpm
 Spray Type: Stream
 Spout Swivel Range: 360°
 Cartridge: 3/8" Ceramic
 Countertop Hole Diameter: 1 3/8"
 Weight: 3 lbs.
 ADA Compliant

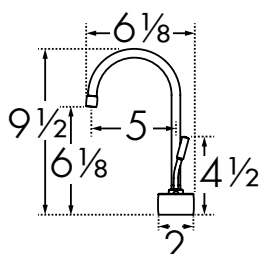

Indicates: Cold Hot Hot/Cold
 ADA Compliant: Product is compliant with the American Disabilities Act when properly installed.
 Faucet supply lines are U.S. standard 3/8" O.D. All faucets can accommodate at least 1 3/4" countertop thickness. Several can accommodate up to 3". Call for additional thickness.

LB7100C

- LB7100C Polished Chrome \$435
- NEW** LB7120C Matte Black \$525
- LB7180C Satin Nickel \$525



FEATURES AND BENEFITS

The Little Butler® Hot Filtered
 Flow Rate: 0.5 gpm
 Spray Type: Stream
 Spout Swivel Range: 360°
 Cartridge: 3/8" Ceramic
 Countertop Hole Diameter: 1 3/8"
 Weight: 3 lbs.
 ADA Compliant

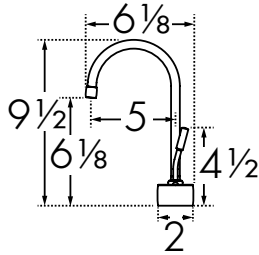

LB10200

- LB10200 Polished Chrome \$580
- NEW** LB10220 Matte Black \$700
- LB10280 Satin Nickel \$700



FEATURES AND BENEFITS

The Little Butler® Hot/Cold Filtered
 Flow Rate: 0.5 gpm
 Spray Type: Stream
 Spout Swivel Range: 360°
 Cartridge: 3/8" Ceramic
 Countertop Hole Diameter: 1 1/4"
 Weight: 3 lbs.
 ADA Compliant

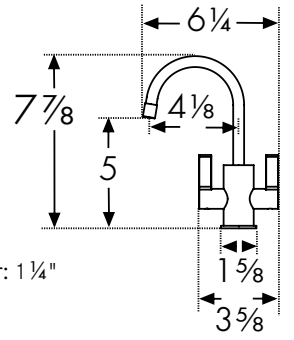

LB7200C

- LB7200C Polished Chrome \$600
- NEW** LB7220C Matte Black \$720
- LB7280C Satin Nickel \$720



FEATURES AND BENEFITS

The Little Butler® Hot/Cold Filtered
 Flow Rate: 0.5 gpm
 Spray Type: Stream
 Spout Swivel Range: 360°
 Cartridge: 3/8" Ceramic
 Countertop Hole Diameter: 1 3/8"
 Weight: 3 lbs.
 ADA Compliant

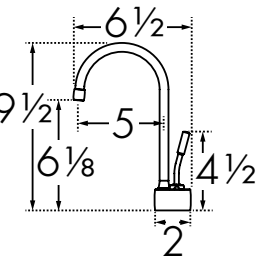

SD3100

- SD3100 Polished Chrome \$130
- NEW** SD3120MBK Matte Black \$165
- SD3180 Satin Nickel \$165



FEATURES AND BENEFITS

Hole Size: 1 1/8"
 Weight: 1 lb.
 Capacity: 10 oz.

Dispenser Head Detail

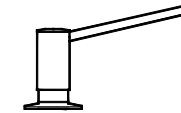

Ambient Dispenser

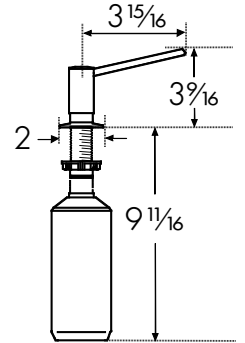

DW10000

- DW10000 Polished Chrome \$460
- NEW** DW10020 Matte Black \$540
- DW10080 Satin Nickel \$540



FEATURES AND BENEFITS

The Little Butler® Cold Filtered
 Flow Rate: 0.5 gpm
 Spray Type: Stream
 Spout Swivel Range: 360°
 Cartridge: 3/8" Ceramic
 Countertop Hole Diameter: 1 1/4"
 Weight: 2 lbs.
 ADA Compliant

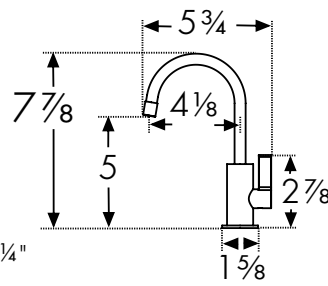

LB10100

- LB10100 Polished Chrome \$460
- NEW** LB10120 Matte Black \$540
- LB10180 Satin Nickel \$540



FEATURES AND BENEFITS

The Little Butler® Hot Filtered
 Flow Rate: 0.5 gpm
 Spray Type: Stream
 Spout Swivel Range: 360°
 Cartridge: 3/8" Ceramic
 Countertop Hole Diameter: 1 1/4"
 Weight: 3 lbs.
 ADA Compliant

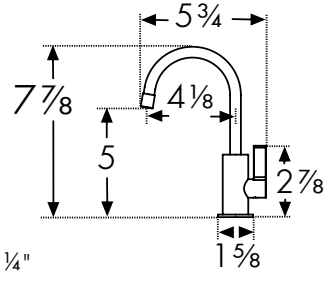

Indicates: Cold Hot Hot/Cold

Indicates: Cold Hot Hot/Cold



Steel

The name says it all: Steel collection faucets blend the **modern look** and inherent sturdiness of solid stainless steel. The **pull-down sprayer** and **360-degree spout swivel** range offer maximum utility for today's hard-working kitchen.

Pictured: FFP3450 faucet, LB13150 filtration faucet and SD3450 soap dispenser

NEW FF3452SS

FF3452SS  Stainless Steel \$850

 Suitable for outdoor use



FEATURES AND BENEFITS

1-Hole Pull-Down
Flow Rate: 1.75 gpm
Spray Function: Toggle
Spray Type: Spray & Stream
Spout Swivel Range: 360°
Cartridge: 35mm Ceramic
Countertop Hole Diameter: 1 3/8"
Weight: 8 lbs.
316 Stainless Steel
ADA Compliant 

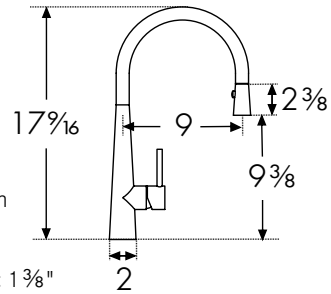

FFPS3450

FFPS3450  Stainless Steel \$635

NEW FFPS3425BSS  Black Stainless Steel \$775



FEATURES AND BENEFITS

1-Hole Pull-Out
Flow Rate: 1.75 gpm
Spray Function: Toggle
Spray Type: Spray & Stream
Spout Swivel Range: 150°
Cartridge: 35mm Ceramic
Countertop Hole Diameter: 1 3/8"
Weight: 8 lbs.
ADA Compliant 

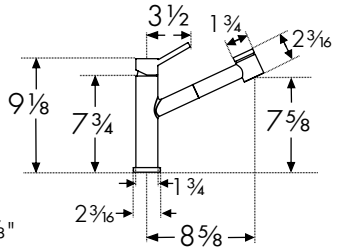

Steel Faucets

FF3450

FF3450  Stainless Steel \$695

NEW FF3425BSS  Black Stainless Steel \$850



FEATURES AND BENEFITS

1-Hole Pull-Down
Flow Rate: 1.75 gpm
Spray Function: Toggle
Spray Type: Spray & Stream
Spout Swivel Range: 360°
Cartridge: 35mm Ceramic
Countertop Hole Diameter: 1 3/8"
Weight: 8 lbs.
ADA Compliant 

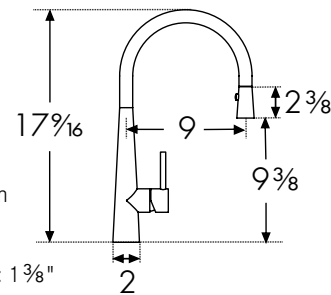

PF3450

PF3450  Stainless Steel \$695

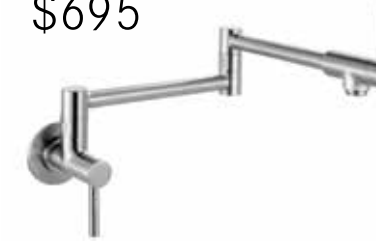

FEATURES AND BENEFITS

Wall Mount Pot Filler
Flow Rate: 2.2 gpm
Spout Swivel Range: 180°
Cartridge: 1/2" Ceramic
Weight: 6 lbs.
ADA Compliant 

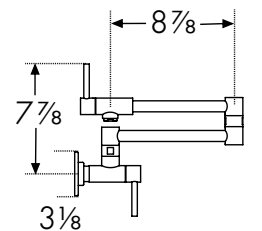

Steel Faucets

FFP3450

FFP3450  Stainless Steel \$635

NEW FFP3425BSS  Black Stainless Steel \$775



FEATURES AND BENEFITS

1-Hole Pull-Down Prep
Flow Rate: 1.75 gpm
Spray Function: Toggle
Spray Type: Spray & Stream
Spout Swivel Range: 360°
Cartridge: 35mm Ceramic
Countertop Hole Diameter: 1 3/8"
Weight: 8 lbs.
ADA Compliant 

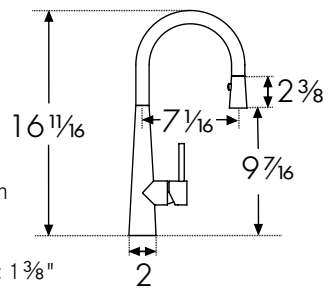

DW13050

DW13050  Stainless Steel \$480

NEW DW13025BSS  Black Stainless Steel \$580



FEATURES AND BENEFITS

The Little Butler® Cold Filtered
Flow Rate: 0.5 gpm
Spray Function: Stream
Spout Swivel Range: 360°
Cartridge: 3/8" Ceramic
Countertop Hole Diameter: 1 1/4"
Weight: 3 lbs.
ADA Compliant 

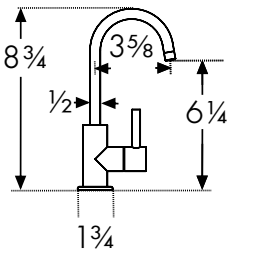

FFB3450

FFB3450  Stainless Steel \$495

NEW FFB3425BSS  Black Stainless Steel \$605



FEATURES AND BENEFITS

1-Hole Bar
Flow Rate: 1.75 gpm
Spray Type: Stream
Spout Swivel Range: 360°
Cartridge: 35mm Ceramic
Countertop Hole Diameter: 1 3/8"
Weight: 5 lbs.
ADA Compliant 

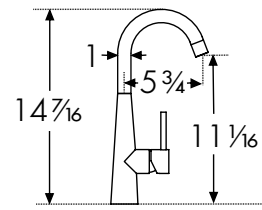

LB13150

LB13150  Stainless Steel \$480

NEW LB13125BSS  Black Stainless Steel \$580



FEATURES AND BENEFITS

The Little Butler® Hot Filtered
Flow Rate: 0.5 gpm
Spray Type: Stream
Spout Swivel Range: 360°
Cartridge: 3/8" Ceramic
Countertop Hole Diameter: 1 1/4"
Weight: 3 lbs.
ADA Compliant 

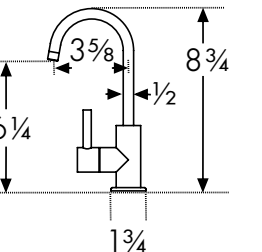



Indicates:  Cold  Hot  Hot/Cold



Steel

LB13250

LB13250  Stainless Steel \$590
NEW LB13225BSS  Black Stainless Steel \$695



FEATURES AND BENEFITS

The Little Butler®
 Hot/Cold Filtered
 Flow Rate: 0.5 gpm
 Spray Type: Stream
 Spout Swivel Range: 360°
 Cartridge: 3/8" Ceramic
 Countertop Hole Diameter: 1 1/4"
 Weight: 4 lbs.
 ADA Compliant 

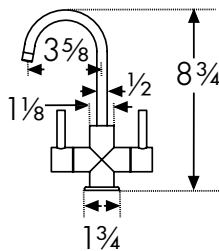

Steel Dispenser

NEW SD3450SS

SD3450SS  Stainless Steel \$250



FEATURES AND BENEFITS

Hole Size: 1 1/8"
 Weight: 1 lb.
 Capacity: 11.5 oz.
 316 Stainless Steel

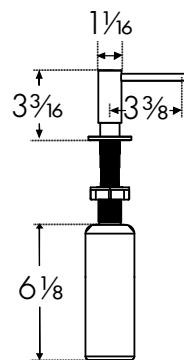

Dispenser Head Detail

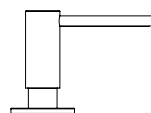

NEW SD3425BSS

SD3425BSS  Black Stainless Steel \$250



FEATURES AND BENEFITS

Hole Size: 1 1/8"
 Weight: 1 lb.
 Capacity: 11.5 oz.

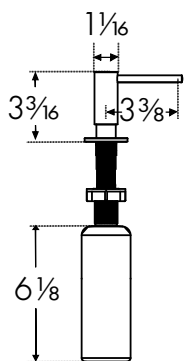

Dispenser Head Detail

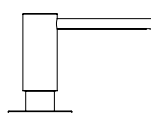

Indicates:  Cold  Hot  Hot/Cold

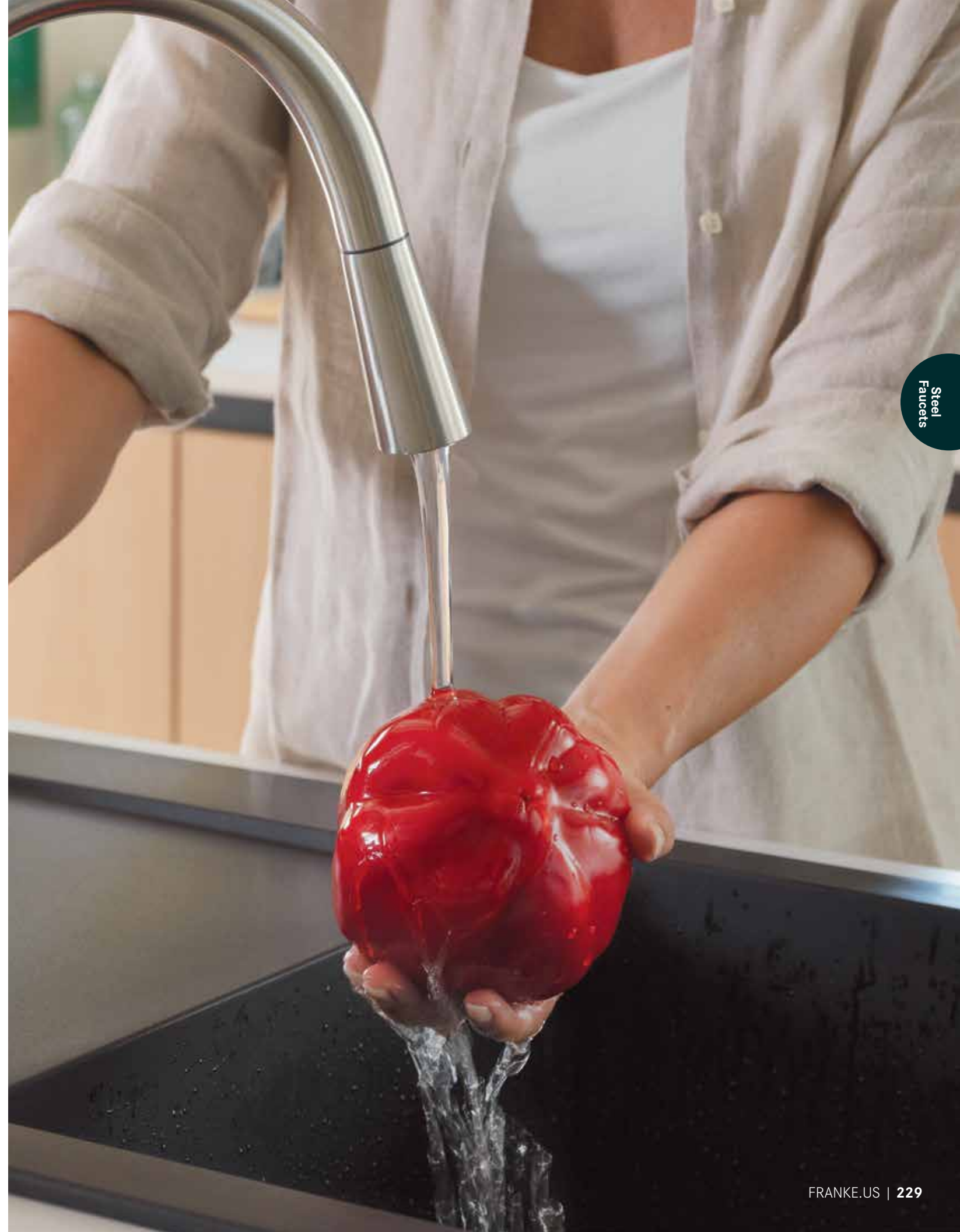

Steel
Faucets

Steel
Faucets



Pictured: FF3920 faucet

Active

Active faucets are perfect for today's busy kitchens and feature the convenience of a **360-degree swivel spray** and a choice of **14 finishes**. The **dual function** spray-head provides **maximum maneuverability** so you can reach every corner of the sink, with a **smooth retraction** that securely puts the hose back into place.



Active



1

Dual Function Spray Head

Spray head has a toggle switch that allows you to effortlessly change between spray and stream.



2

Variety of Finish Options

Choose from an array of finish options. Make it match with the granite color palette from Active Plus or choose from a wide selection of metal finishes from Active Neo.



Active Plus FF3800

| | | |
|--------|-----------------|-------|
| FF3800 | Polished Chrome | \$610 |
| FF3801 | Onyx | \$720 |
| FF3802 | Mocha | \$720 |
| FF3803 | Storm | \$720 |
| FF3804 | Oyster | \$720 |
| FF3805 | Champagne | \$720 |
| FF3807 | Stone Grey | \$720 |
| FF3880 | Satin Nickel | \$720 |



FEATURES AND BENEFITS

1-Hole Pull-Out
Flow Rate: 1.75 gpm
Spray Function: Toggle
Spray Type: Spray & Stream
Spout Swivel Range: 360°
Cartridge: 35mm Ceramic
Countertop Hole Diameter: 1 3/8"
Weight: 7 lbs.
ADA Compliant

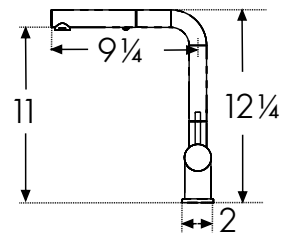

Active Neo FF3900

| | | |
|-------------------------------------|-----------------|-------|
| FF3900 | Polished Chrome | \$610 |
| FF3920 | Matte Black | \$720 |
| FF3922 | Shiny Black | \$720 |
| FF3940 | Gun Metal | \$720 |
| <i>Limited Quantities Available</i> | | |
| FF3961 | Copper | \$720 |
| FF3965 | Bronze | \$720 |
| FF3980 | Satin Nickel | \$720 |
| FF3990 | Satin Brass | \$720 |



FEATURES AND BENEFITS

1-Hole Pull-Down
Flow Rate: 1.75 gpm
Spray Type: Toggle
Spray Type: Spray & Stream
Spout Swivel Range: 360°
Cartridge: 35mm Ceramic
Countertop Hole Diameter: 1 3/8"
Weight: 8 lbs.
ADA Compliant

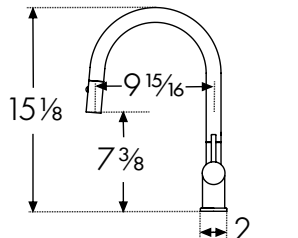

SD3200

| | | |
|-------------------------------------|-----------------|-------|
| SD3200 | Polished Chrome | \$125 |
| SD3201 | Onyx | \$160 |
| SD3202 | Mocha | \$160 |
| SD3203 | Storm | \$160 |
| SD3204 | Oyster | \$160 |
| SD3205 | Champagne | \$160 |
| SD3207 | Stone Grey | \$160 |
| SD3220 | Matte Black | \$160 |
| SD3222 | Shiny Black | \$160 |
| SD3240 | Gun Metal | \$160 |
| <i>Limited Quantities Available</i> | | |
| SD3261 | Copper | \$160 |



FEATURES AND BENEFITS

Hole Size: 1 1/8"
Weight: 1 lb.
Capacity: 10 oz.

| | | |
|--------|--------------|-------|
| SD3265 | Bronze | \$160 |
| SD3280 | Satin Nickel | \$160 |
| SD3290 | Satin Brass | \$160 |

Active Dispenser

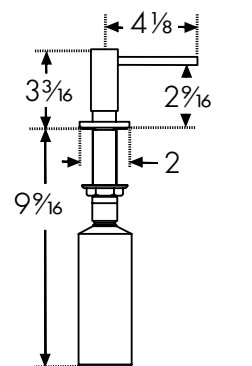

Kubus

Kubus faucets bring a strikingly simple design to your kitchen while offering a **host of useful features** including a cleverly designed **pull-down spray**. When work is complete, the hose neatly retracts. The inclined design is the perfect height for large pots.



Pictured: FF4250 faucet

FF4250

FF4250 ■ Stainless Steel

\$600



FEATURES AND BENEFITS

1-Hole Pull-Down
 Flow Rate: 1.75 gpm
 Spray Function: Toggle
 Spray Type: Spray & Stream
 Spout Swivel Range: 180°
 Cartridge: 35mm Ceramic
 Countertop Hole Diameter: 1 3/8"
 Weight: 7 lbs.
 ADA Compliant 

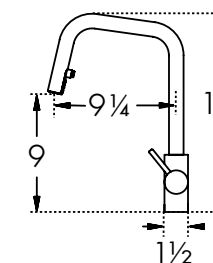

FFP4250

FFP4250 ■ Stainless Steel

\$540



FEATURES AND BENEFITS

1-Hole Pull-Down Prep
 Flow Rate: 1.75 gpm
 Spray Function: Toggle
 Spray Type: Spray & Stream
 Spout Swivel Range: 180°
 Cartridge: 35mm Ceramic
 Countertop Hole Diameter: 1 3/8"
 Weight: 6 lbs.
 ADA Compliant 

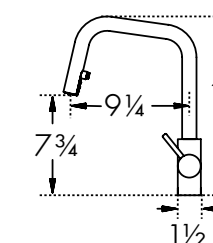

FFB4250

FFB4250 ■ Stainless Steel

\$435



FEATURES AND BENEFITS

1-Hole Bar
 Flow Rate: 1.75 gpm
 Spray Type: Stream
 Spout Swivel Range: 180°
 Cartridge: 35mm Ceramic
 Countertop Hole Diameter: 1 3/8"
 Weight: 4 lbs.
 ADA Compliant 

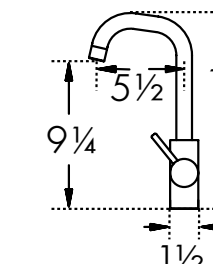



Pictured: FF3350 faucet

Cube

The sleek **steel styling** of Cube faucets brings **modern chic** to your kitchen. Complement your kitchen sink with a Cube prep or bar sink for a stylish look throughout.



FF3352

FF3352  Stainless Steel

\$750

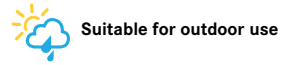

FEATURES AND BENEFITS

1-Hole Pull-Down
 Flow Rate: 1.75 gpm
 Spray Function: Toggle
 Spray Type: Spray & Stream
 Spout Swivel Range: 360°
 Cartridge: 35mm Ceramic
 Countertop Hole Diameter: 1 3/8"
 Weight: 10 lbs.
 316 Stainless Steel
 ADA Compliant 

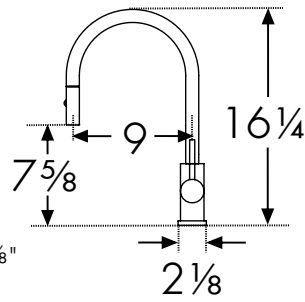

FFB3350

FFB3350  Stainless Steel

\$475



FFB3325BSS  Black Stainless Steel

\$580



FEATURES AND BENEFITS

1-Hole Bar
 Flow Rate: 1.75 gpm
 Spray Type: Stream
 Spout Swivel Range: 360°
 Cartridge: 35mm Ceramic
 Countertop Hole Diameter: 1 3/8"
 Weight: 7 lbs.
 ADA Compliant 

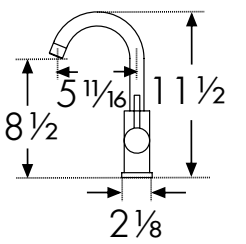

FF3350

FF3350  Stainless Steel

\$615



FF3325BSS  Black Stainless Steel

\$750



FEATURES AND BENEFITS

1-Hole Pull-Down
 Flow Rate: 1.75 gpm
 Spray Function: Toggle
 Spray Type: Spray & Stream
 Spout Swivel Range: 360°
 Cartridge: 35mm Ceramic
 Countertop Hole Diameter: 1 3/8"
 Weight: 10 lbs.
 ADA Compliant 

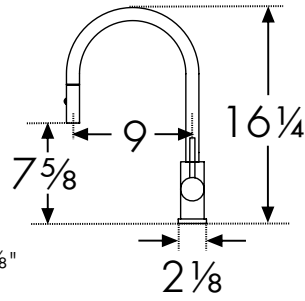

FFT3350

FFT3350  Stainless Steel

\$585



FEATURES AND BENEFITS

3 in 1 Hot/Cold/Filtered Cold
 Flow Rate: 1.75 gpm/0.5 gpm
 Spray Type: Full & Stream
 Spout Swivel Range: 360°
 Cartridge: 35mm Ceramic
 Countertop Hole Diameter: 1 3/8"
 Weight: 7 lbs.
 ADA Compliant 

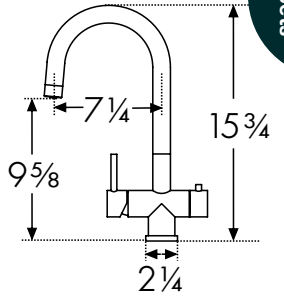

Note: Filter is not included. Please reference pages 249-253 for filtration options.

FFPD3350

FFPD3350  Stainless Steel

\$585



FEATURES AND BENEFITS

1-Hole Pull-Down, 2 Handle
 Flow Rate: 1.75 gpm
 Spray Function: Toggle
 Spray Type: Spray & Stream
 Spout Swivel Range: 360°
 Cartridge: 1/2" Ceramic
 Countertop Hole Diameter: 1 3/8"
 Weight: 8 lbs.
 ADA Compliant 

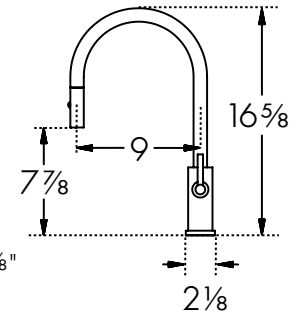

FFP3350

FFP3350  Stainless Steel

\$585



FFP3325BSS  Black Stainless Steel

\$715



FEATURES AND BENEFITS

1-Hole Prep
 Flow Rate: 1.75 gpm
 Spray Function: Toggle
 Spray Type: Spray & Stream
 Spout Swivel Range: 360°
 Cartridge: 35mm Ceramic
 Countertop Hole Diameter: 1 3/8"
 Weight: 10 lbs.
 ADA Compliant 

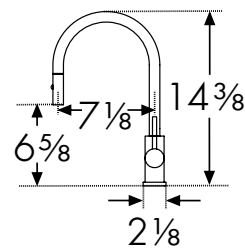

Indicates:  Cold  Hot  Hot/Cold



Every drop is wonderful

Franke pioneered multi-tasking kitchen faucets. Today, our beautifully designed range of point-of-use faucets, which dispense hot, cold and filtered water, are considered the blueprint for faucets that go the extra step. By combining the beauty of our most stylish designs and the technologically advanced ceramic water filtration of the Franke StillPure system, we've created the perfect addition to a health-focused kitchen.

PURE WATER WHEN YOU NEED IT.

Invisible to the eye and even to the tongue, contaminants, lead, toxins, industrial pollutants, pesticides and even diseases are passed through local water systems into our homes. Unfortunately, filtration pitchers don't fully filter out impurities, and bottled water creates waste. Franke StillPure delivers **delicious, water right from the tap.**

STYLED FOR CONVENIENCE.

With the Franke **StillPure filtration** system you can choose from a full range of faucet designs to fit your style.

CONFIDENCE TO KNOW IT'S PURE.

When you understand the importance of filtered water, you'll want to use StillPure for everything you do in your kitchen. That's why we created point-of-use faucets that deliver filtered water where and when you need it. Instantly rinse, prep and cook with the clean water. With Franke StillPure, it's always right at hand.



Point-of-Use Filtration Faucet



Undercounter Water Filter



Heating Tank



Water Chiller

Cube
FFT3350

FFT3350 ■ Stainless Steel

\$585



FEATURES AND BENEFITS

3 in 1 Hot/Cold/Filtered Cold
Flow Rate: 1.75 gpm/0.5 gpm
Spray Type: Full & Stream
Spout Swivel Range: 360°
Cartridge: 35mm Ceramic
Countertop Hole Diameter: 1 3/8"
Weight: 7 lbs.
ADA Compliant

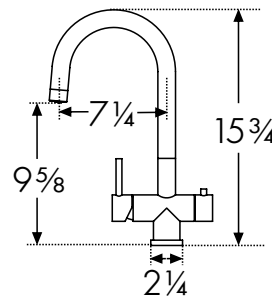

Note: Filter is not included. Please reference pages 249-253 for filtration options.

Ambient
FFT3100

FFT3100 ■ Polished Chrome \$580
FFT3180 ■ Satin Nickel \$690



FEATURES AND BENEFITS

3 in 1 Hot/Cold/Filtered Cold
Flow Rate: 1.75 gpm/0.5 gpm
Spray Type: Stream
Spout Swivel Range: 360°
Cartridge: 28mm Ceramic
Countertop Hole Diameter: 1 3/8"
Weight: 6 lbs.
ADA Compliant

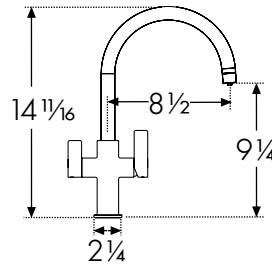

Note: Filter is not included. Please reference pages 249-253 for filtration options.



Absinthe
FFT5200

FFT5200 ■ Polished Chrome \$640
FFT5220 ■ Matte Black \$780
FFT5280 ■ Satin Nickel \$780



FEATURES AND BENEFITS

3 in 1 Hot/Cold/Filtered Cold
Flow Rate: 1.75 gpm/0.5 gpm
Spray Type: Stream
Spout Swivel Range: 360°
Cartridge: 28mm Ceramic
Countertop Hole Diameter: 1 3/8"
Weight: 10 lbs.
ADA Compliant

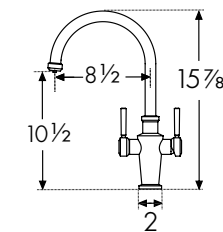

Note: Filter is not included. Please reference pages 249-253 for filtration options.

Farm House
DW6100C

Limited Quantities Available
DW6100C ■ Polished Chrome \$435
DW6180C ■ Satin Nickel \$525



FEATURES AND BENEFITS

The Little Butler® Cold Filtered
Flow Rate: 0.5 gpm
Spray Type: Stream
Spout Swivel Range: 360°
Cartridge: 3/8" Ceramic
Countertop Hole Diameter: 1 3/8"
Weight: 3 lbs.
ADA Compliant

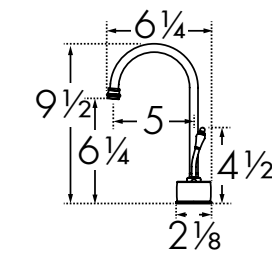

Indicates: Cold Hot Hot/Cold

Farm House
LB6100C

Limited Quantities Available
LB6100C ■ Polished Chrome \$435
LB6180C ■ Satin Nickel \$525



FEATURES AND BENEFITS

The Little Butler® Hot Filtered
Flow Rate: 0.5 gpm
Spray Type: Stream
Spout Swivel Range: 360°
Cartridge: 3/8" Ceramic
Countertop Hole Diameter: 1 3/8"
Weight: 3 lbs.
ADA Compliant

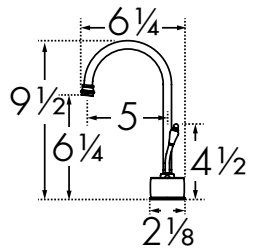

Farm House
LB6200C

Limited Quantities Available
LB6200C ■ Polished Chrome \$600
LB6280C ■ Satin Nickel \$720



FEATURES AND BENEFITS

The Little Butler® Hot/Cold Filtered
Flow Rate: 0.5 gpm
Spray Type: Stream
Spout Swivel Range: 360°
Cartridge: 3/8" Ceramic
Countertop Hole Diameter: 1 3/8"
Weight: 3 lbs.
ADA Compliant

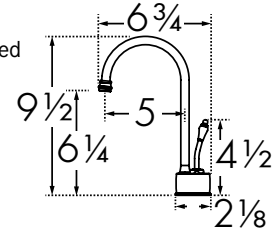

Farm House
DW12000

Limited Quantities Available
DW12000 ■ Polished Chrome \$460
DW12080 ■ Satin Nickel \$540



FEATURES AND BENEFITS

The Little Butler® Cold Filtered
Flow Rate: 0.5 gpm
Spray Type: Stream
Spout Swivel Range: 360°
Cartridge: 3/8" Ceramic
Countertop Hole Diameter: 1 1/4"
Weight: 2 lbs.
ADA Compliant

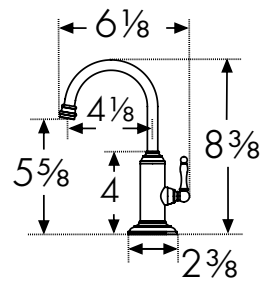

Farm House
LB12100

Limited Quantities Available
LB12100 ■ Polished Chrome \$460
LB12180 ■ Satin Nickel \$540



FEATURES AND BENEFITS

The Little Butler® Hot Filtered
Flow Rate: 0.5 gpm
Spray Type: Stream
Spout Swivel Range: 360°
Cartridge: 3/8" Ceramic
Countertop Hole Diameter: 1 1/4"
Weight: 3 lbs.
ADA Compliant

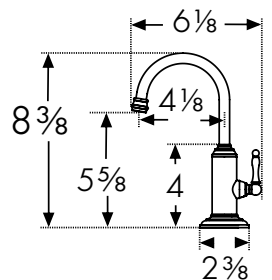

Indicates: Cold Hot Hot/Cold

Farm House
LB12200

Limited Quantities Available

- LB12200** Polished Chrome \$580
- LB12280** Satin Nickel \$700



FEATURES AND BENEFITS

The Little Butler® Hot/Cold Filtered
Flow Rate: 0.5 gpm
Spray Type: Stream
Spout Swivel Range: 360°
Cartridge: 3/8" Ceramic
Countertop Hole Diameter: 1 1/4"
Weight: 4 lbs.
ADA Compliant

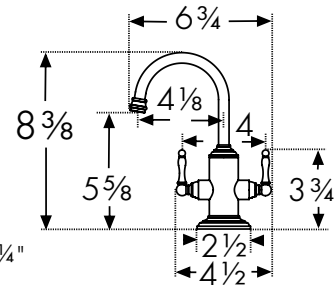

Absinthe
DW15000

- DW15000** Polished Chrome \$475
- DW15020** Matte Black \$555
- DW15080** Satin Nickel \$555
- DW15090** Satin Brass \$555



FEATURES AND BENEFITS

The Little Butler® Cold Filtered
Flow Rate: 0.5
Spray Type: Stream
Spout Swivel Range: 360°
Cartridge: 3/8" Ceramic
Countertop Hole Diameter: 1 1/4"
Weight: 3 lbs.
ADA Compliant

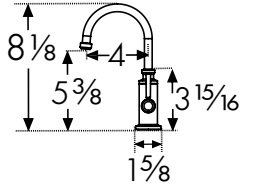

Logik
DW9000C

- DW9000C** Polished Chrome \$425
- DW9080C** Satin Nickel \$515



FEATURES AND BENEFITS

The Little Butler® Cold Filtered
Flow Rate: 0.5 gpm
Spray Function: Stream
Spout Swivel Range: 360°
Cartridge: 3/8" Ceramic
Countertop Hole Diameter: 1 3/8"
Weight: 3 lbs.
ADA Compliant

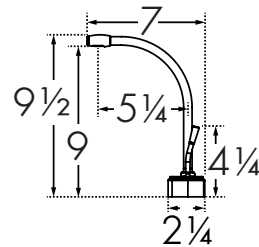

Absinthe
LB15100

- LB15100** Polished Chrome \$475
- LB15120** Matte Black \$555
- LB15180** Satin Nickel \$555
- LB15190** Satin Brass \$555



FEATURES AND BENEFITS

The Little Butler® Hot Filtered
Flow Rate: 0.5
Spray Type: Stream
Spout Swivel Range: 360°
Cartridge: 3/8" Ceramic
Countertop Hole Diameter: 1 1/4"
Weight: 3 lbs.
ADA Compliant

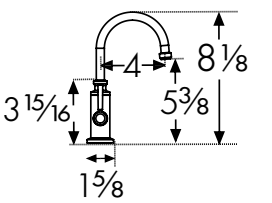

Logik
LB9100C

- LB9100C** Polished Chrome \$425
- LB9180C** Satin Nickel \$515



FEATURES AND BENEFITS

The Little Butler® Hot Filtered
Flow Rate: 0.5 gpm
Spray Type: Stream
Spout Swivel Range: 360°
Cartridge: 3/8" Ceramic
Countertop Hole Diameter: 1 3/8"
Weight: 3 lbs.
ADA Compliant

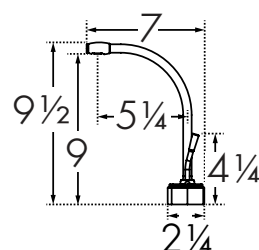

Absinthe
LB15200

- LB15200** Polished Chrome \$580
- LB15220** Matte Black \$700
- LB15280** Satin Nickel \$700
- LB15290** Satin Brass \$700



FEATURES AND BENEFITS

The Little Butler® Hot/Cold Filtered
Flow Rate: 0.5
Spray Type: Stream
Spout Swivel Range: 360°
Cartridge: 3/8" Ceramic
Countertop Hole Diameter: 1 1/4"
Weight: 3 lbs.
ADA Compliant

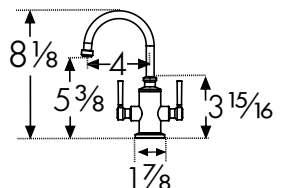

Logik
LB9200C

- LB9200C** Polished Chrome \$590
- LB9280C** Satin Nickel \$700



FEATURES AND BENEFITS

The Little Butler® Hot/Cold Filtered
Flow Rate: 0.5 gpm
Spray Type: Stream
Spout Swivel Range: 360°
Cartridge: 3/8" Ceramic
Countertop Hole Diameter: 1 3/8"
Weight: 3 lbs.
ADA Compliant

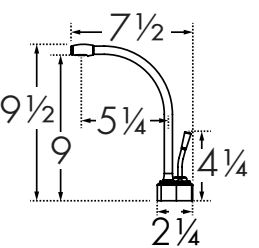

Pescara
DW16000

- DW16000** Polished Chrome \$460
- DW16020** Matte Black \$540
- DW16022** Shiny Black \$540
- DW16040** Gun Metal \$540
- DW16061** Copper \$540
- DW16065** Bronze \$540
- DW16080** Satin Nickel \$540
- DW16090** Satin Brass \$540



FEATURES AND BENEFITS

The Little Butler® Cold Filtered
Flow Rate: 0.5
Spray Type: Stream
Spout Swivel Range: 360°
Cartridge: 3/8" Ceramic
Countertop Hole Diameter: 1 1/4"
Weight: 3 lbs.
ADA Compliant

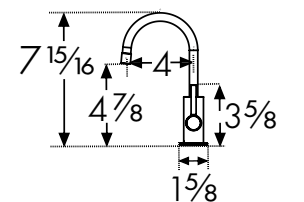

Indicates: Cold Hot Hot/Cold

Indicates: Cold Hot Hot/Cold

ADA Compliant: Product is compliant with the American Disabilities Act when properly installed. All faucets can accommodate at least 1-3/4" countertop thickness. Several can accommodate up to 3". Call for additional thicknesses. Recommended Pressure Range: 15-75 PSI. All Franke filtration faucets have been certified to comply with NSF61 and NSF372 drinking water system component requirements. These requirements meet California Health and Safety Code requirements for low lead (AB1953) as well as the low lead requirements of the US Safe Drinking Water Act. Franke faucets also meet the water efficiency requirements of the California Energy Commission and the US Department of Energy.

ADA Compliant: Product is compliant with the American Disabilities Act when properly installed. All faucets can accommodate at least 1-3/4" countertop thickness. Several can accommodate up to 3". Call for additional thicknesses. Recommended Pressure Range: 15-75 PSI. All Franke filtration faucets have been certified to comply with NSF61 and NSF372 drinking water system component requirements. These requirements meet California Health and Safety Code requirements for low lead (AB1953) as well as the low lead requirements of the US Safe Drinking Water Act. Franke faucets also meet the water efficiency requirements of the California Energy Commission and the US Department of Energy.

Pescara
LB16100

| | | | |
|---------|--|-----------------|-------|
| LB16100 | | Polished Chrome | \$460 |
| LB16120 | | Matte Black | \$540 |
| LB16122 | | Shiny Black | \$540 |
| LB16140 | | Gun Metal | \$540 |
| LB16161 | | Copper | \$540 |
| LB16165 | | Bronze | \$540 |
| LB16180 | | Satin Nickel | \$540 |
| LB16190 | | Satin Brass | \$540 |



FEATURES AND BENEFITS

The Little Butler® Hot Filtered
Flow Rate: 0.5
Spray Type: Stream
Spout Swivel Range: 360°
Cartridge: 3/8" Ceramic
Countertop Hole Diameter: 1 1/4"
Weight: 3 lbs.
ADA Compliant

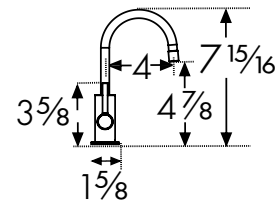

Ambient
LB7100C

| | | | |
|---------|--|-----------------|-------|
| LB7100C | | Polished Chrome | \$435 |
| LB7120C | | Matte Black | \$525 |
| LB7180C | | Satin Nickel | \$525 |



FEATURES AND BENEFITS

The Little Butler® Hot Filtered
Flow Rate: 0.5 gpm
Spray Type: Stream
Spout Swivel Range: 360°
Cartridge: 3/8" Ceramic
Countertop Hole Diameter: 1 3/8"
Weight: 3 lbs.
ADA Compliant

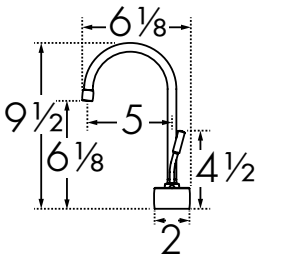

Pescara
LB16200

| | | | |
|---------|--|-----------------|-------|
| LB16200 | | Polished Chrome | \$580 |
| LB16220 | | Matte Black | \$700 |
| LB16222 | | Shiny Black | \$700 |
| LB16240 | | Gun Metal | \$700 |
| LB16261 | | Copper | \$700 |
| LB16265 | | Bronze | \$700 |
| LB16280 | | Satin Nickel | \$700 |
| LB16290 | | Satin Brass | \$700 |



FEATURES AND BENEFITS

The Little Butler® Hot/Cold Filtered
Flow Rate: 0.5
Spray Type: Stream
Spout Swivel Range: 360°
Cartridge: 3/8" Ceramic
Countertop Hole Diameter: 1 1/4"
Weight: 3 lbs.
ADA Compliant

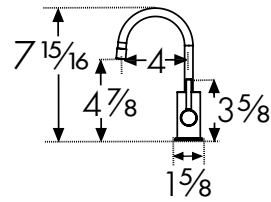

Ambient
LB7200C

| | | | |
|---------|--|-----------------|-------|
| LB7200C | | Polished Chrome | \$600 |
| LB7220C | | Matte Black | \$720 |
| LB7280C | | Satin Nickel | \$720 |



FEATURES AND BENEFITS

The Little Butler® Hot/Cold Filtered
Flow Rate: 0.5 gpm
Spray Type: Stream
Spout Swivel Range: 360°
Cartridge: 3/8" Ceramic
Countertop Hole Diameter: 1 3/8"
Weight: 3 lbs.
ADA Compliant

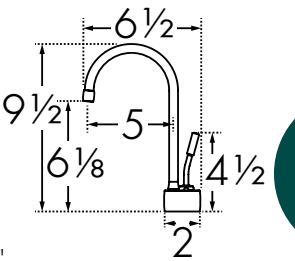

Ambient
DW7000C

| | | | |
|---------|--|-----------------|-------|
| DW7000C | | Polished Chrome | \$435 |
| DW7020C | | Matte Black | \$525 |
| DW7080C | | Satin Nickel | \$525 |



FEATURES AND BENEFITS

The Little Butler® Cold Filtered
Flow Rate: 0.5 gpm
Spray Type: Stream
Spout Swivel Range: 360°
Cartridge: 3/8" Ceramic
Countertop Hole Diameter: 1 3/8"
Weight: 3 lbs.
ADA Compliant

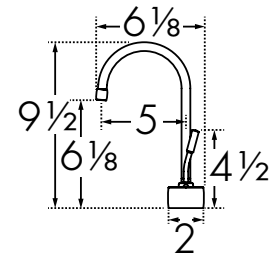

Ambient
DW10000

| | | | |
|---------|--|-----------------|-------|
| DW10000 | | Polished Chrome | \$460 |
| DW10020 | | Matte Black | \$540 |
| DW10080 | | Satin Nickel | \$540 |



FEATURES AND BENEFITS

The Little Butler® Cold Filtered
Flow Rate: 0.5 gpm
Spray Type: Stream
Spout Swivel Range: 360°
Cartridge: 3/8" Ceramic
Countertop Hole Diameter: 1 1/4"
Weight: 2 lbs.
ADA Compliant

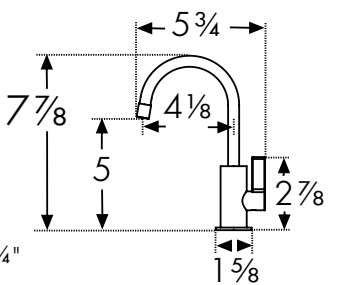

Ambient
LB10100

| | | | |
|---------|--|-----------------|-------|
| LB10100 | | Polished Chrome | \$460 |
| LB10120 | | Matte Black | \$540 |
| LB10180 | | Satin Nickel | \$540 |



FEATURES AND BENEFITS

The Little Butler® Hot Filtered
Flow Rate: 0.5 gpm
Spray Type: Stream
Spout Swivel Range: 360°
Cartridge: 3/8" Ceramic
Countertop Hole Diameter: 1 1/4"
Weight: 3 lbs.
ADA Compliant

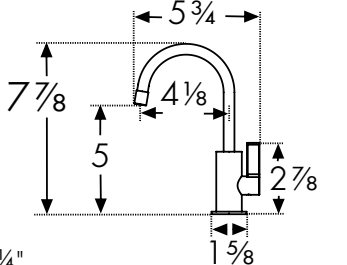

Indicates: Cold Hot Hot/Cold

Indicates: Cold Hot Hot/Cold

ADA Compliant: Product is compliant with the American Disabilities Act when properly installed.
All faucets can accommodate at least 1-3/4" countertop thickness. Several can accommodate up to 3". Call for additional thicknesses. Recommended Pressure Range: 15-75 PSI. All Franke filtration faucets have been certified to comply with NSF61 and NSF372 drinking water system component requirements. These requirements meet California Health and Safety Code requirements for low lead (AB1953) as well as the low lead requirements of the US Safe Drinking Water Act. Franke faucets also meet the water efficiency requirements of the California Energy Commission and the US Department of Energy.

ADA Compliant: Product is compliant with the American Disabilities Act when properly installed.
All faucets can accommodate at least 1-3/4" countertop thickness. Several can accommodate up to 3". Call for additional thicknesses. Recommended Pressure Range: 15-75 PSI. All Franke filtration faucets have been certified to comply with NSF61 and NSF372 drinking water system component requirements. These requirements meet California Health and Safety Code requirements for low lead (AB1953) as well as the low lead requirements of the US Safe Drinking Water Act. Franke faucets also meet the water efficiency requirements of the California Energy Commission and the US Department of Energy.

Ambient
LB10200

- LB10200** Polished Chrome \$580
- NEW LB10220** Matte Black \$700
- LB10280** Satin Nickel \$700



FEATURES AND BENEFITS

The Little Butler® Hot/Cold Filtered
Flow Rate: 0.5 gpm
Spray Type: Stream
Spout Swivel Range: 360°
Cartridge: 3/8" Ceramic
Countertop Hole Diameter: 1 1/4"
Weight: 3 lbs.
ADA Compliant

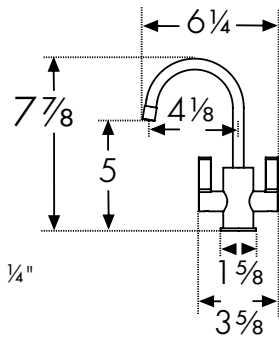

Steel
DW13050

- DW13050** Stainless Steel \$480
- NEW DW13025BSS** Black Stainless Steel \$580



FEATURES AND BENEFITS

The Little Butler® Cold Filtered
Flow Rate: 0.5 gpm
Spray Function: Stream
Spout Swivel Range: 360°
Cartridge: 3/8" Ceramic
Countertop Hole Diameter: 1 1/4"
Weight: 3 lbs.
ADA Compliant

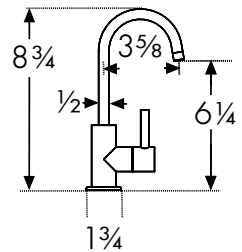

Steel
LB13150

- LB13150** Stainless Steel \$480
- NEW LB13125BSS** Black Stainless Steel \$580



FEATURES AND BENEFITS

The Little Butler® Hot Filtered
Flow Rate: 0.5 gpm
Spray Type: Stream
Spout Swivel Range: 360°
Cartridge: 3/8" Ceramic
Countertop Hole Diameter: 1 1/4"
Weight: 3 lbs.
ADA Compliant

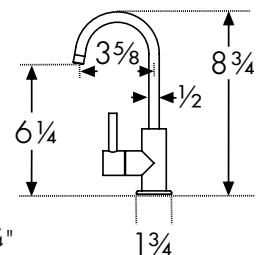

Steel
LB13250

- LB13250** Stainless Steel \$590
- NEW LB13225BSS** Black Stainless Steel \$695



FEATURES AND BENEFITS

The Little Butler® Hot/Cold Filtered
Flow Rate: 0.5 gpm
Spray Type: Stream
Spout Swivel Range: 360°
Cartridge: 3/8" Ceramic
Countertop Hole Diameter: 1 1/4"
Weight: 4 lbs.
ADA Compliant

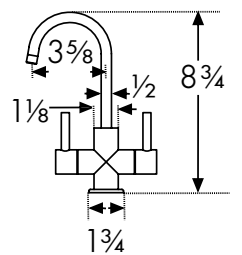

Indicates: Cold Hot Hot/Cold

HT-400 \$460

The Little Butler® Heating Tank

For use with all Franke hot only and hot/cold filtration faucets.



FEATURES AND BENEFITS

- Heats up to 60 cups per hour close to boiling temperature
- 8 pre-set temperature settings
- Electronic temperature control, max 208 degrees
- 3/8 gallon stainless steel tank
- 1100 Watts
- 5 year warranty
- 8 lbs.
- Compatible with RO water systems

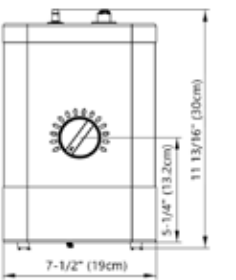

CT-200 \$1,035

The Little Butler® Chiller

For use with all Franke cold only filtration faucets.



FEATURES AND BENEFITS

- Chills 1 gallon per hour
- Water temperature 40 degrees
- Power: cord, 4 feet, 115 volts, 60 HZ
- 135 Watts
- Stainless steel tank & tubing
- 1 year limited warranty
- 25 lbs.
- Compatible with RO water systems

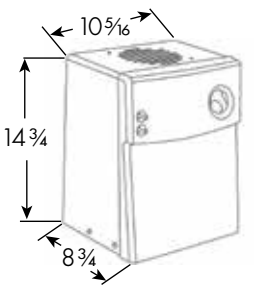

FRCNSTR100 \$220

Filtration Canister

FRCNSTR \$335

Filtration Canister



FEATURES AND BENEFITS

- FRC06 filter cartridge included
- Fits FRC06, FRC07, FRC08, FRC09 and FRC10 filters
- Thermoplastic housing
- Built-in shutoff valve
- Integrated installation bracket
- Quick connect 3/8" push fitting
- 10 year warranty
- BPA Free
- 3 lbs.

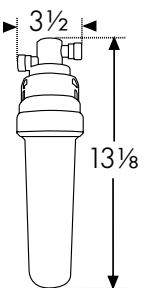

FEATURES AND BENEFITS

- FRC06 filter cartridge included
- Fits FRC06, FRC07, FRC08, FRC09 and FRC10 filters
- Solid stainless steel housing
- Easy installation bracket included
- Quick connect 3/8" push fitting
- 5 year warranty
- 4 lbs.

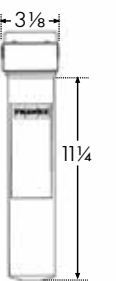

FRCNSTR-DUO-1 \$370

Dual Filtration Canister



FEATURES AND BENEFITS

- FRC06 and FRC09 filters included
- Fits FRC06, FRC07, FRC08, FRC09 and FRC10 filters
- Thermoplastic housing
- Built-in shutoff valve
- Integrated installation bracket
- Quick connect 3/8" push fitting
- 10 year warranty
- BPA Free
- 6 lbs.

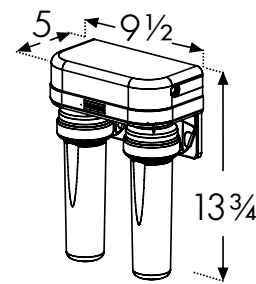

FRCNSTR-DUO-2 \$370

Dual Filtration Canister



FEATURES AND BENEFITS

- FRC07 and FRC09 filters included
- Fits FRC06, FRC07, FRC08, FRC09 and FRC10 filters
- Thermoplastic housing
- Built-in shutoff valve
- Integrated installation bracket
- Quick connect 3/8" push fitting
- 10 year warranty
- BPA Free
- 6 lbs.

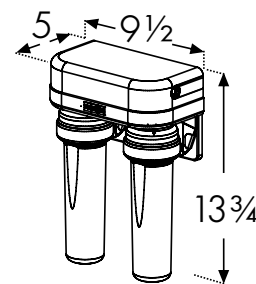

How to determine which filter to order if the replacement filter model number is not identified on the canister:

1. Locate the serial number on your canister
2. If the serial number begins with FR then order the FRX02 filter set
3. If the serial number begins with FRC then order the FRC06, FRC07, FRC08, FRC09, FRC10 filter set

Contaminant Reduction Overview

| FILTRATION CRITERIA | PRIMARY FILTERS | | | PRE-FILTERS | | |
|-------------------------------------|-----------------|-------|-------|-------------|-------|-------|
| | FRX02 | FRC06 | FRC07 | FRC08 | FRC09 | FRC10 |
| Reduces Chlorine | X | X | X | | | |
| Reduces Chloramine | | | X | | | |
| Reduces Particulates and Turbidity | X | X | X | | | |
| Reduces Cysts (Cryptosporidium) | X | X | X | | | |
| Reduces Bacteria (E Coli) | X | X | X | | | |
| Reduces Insecticides and Herbicides | X | X | X | | | |
| Reduces Lead | X | X | | | | |
| Reduces Fluoride | | | | X | | |
| Reduces Sediment | | | | | X | |
| Reduces Limescale and Hardness | | | | | | X |

Note: See individual filter product data sheets for details on specific contaminants filtered.

FRX02

\$85

Filter



FEATURES AND BENEFITS

- Reduces:
- Chlorine (taste and odor)
 - Particulate and turbidity
 - Cysts (Cryptosporidium)
 - Lead
- Note: See filter product data sheet for details on specific contaminants filtered.

1 lb.

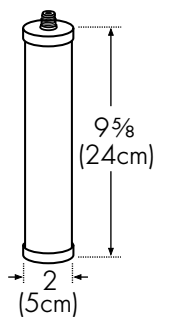

FRC06 \$85
FRC06-2PK \$155

Filter



FEATURES AND BENEFITS

Reduces:
 • Chlorine (taste and odor)
 • Particulate and turbidity
 • Cysts (Cryptosporidium)
 • Lead
 Note: See filter product data sheet for details on specific contaminants filtered.
 1 lb.

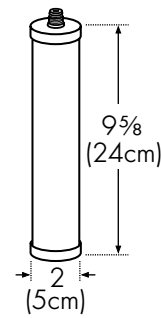

FRC10 \$100

Filter



FEATURES AND BENEFITS

• Removes temporary hardness in drinking water
 • Removes Calcium and Magnesium
 • Limescale reduction
 Note: See filter product data sheet for details on specific contaminants filtered.
 1 lb.

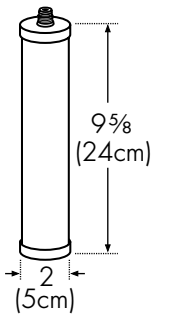

FRC07 \$85

Filter



FEATURES AND BENEFITS

Reduces:
 • Chloramine
 • Chlorine (taste and odor)
 • Particulate and turbidity
 Note: See filter product data sheet for details on specific contaminants filtered.
 1 lb.

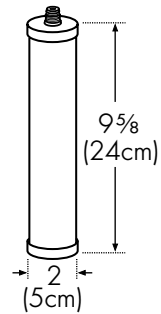

SB60 \$45

Pressure Protection Valve



FEATURES AND BENEFITS

Flow Rate: 4 gpm @ 100 psi
 Max Pressure: 300 psi
 Max Temperature: 104°F (40°C)
 Type: SB60 limiting valve, 60 psi
 Pipe: 1/4" - Inlet/Outlet Quick Connect
 Weight: 1 lb.

FRC08 \$85

Filter



FEATURES AND BENEFITS

Reduces:
 • Flouride
 Note: See filter product data sheet for details on specific contaminants filtered.
 1 lb.

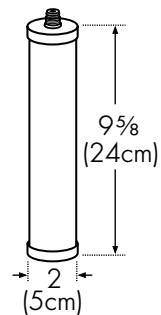

FRC09 \$50

Filter



FEATURES AND BENEFITS

Reduces:
 • Sediment
 Note: See filter product data sheet for details on specific contaminants filtered.
 1 lb.

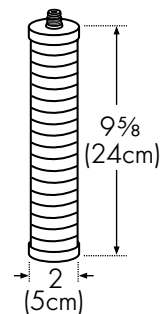



Pictured: SD3200 dispenser

Soap Dispensers

With styles to complement every Franke faucet, our **Soap Dispensers** are a must-have for today's busy kitchens. With an **easy-to-operate** hand pump, cleanliness is always within your reach.



Square
SD-800

- SD-800**  Polished Chrome \$400
- SD-880N**  Satin Nickel \$480



FEATURES AND BENEFITS

Hole Size: 1 1/8"
Weight: 3 lbs.
Capacity: 16 oz.

Dispenser Head Detail

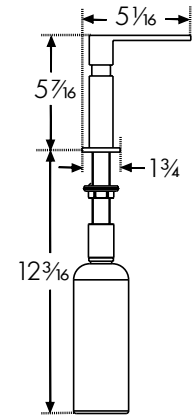
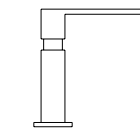

Steel
SD3425BSS

- SD3425BSS**  Black Stainless Steel \$250





FEATURES AND BENEFITS

Hole Size: 1 1/8"
Weight: 1 lb.
Capacity: 11.5 oz.

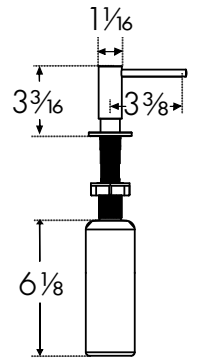
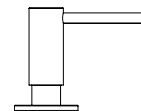
Dispenser Head Detail



Twin
SD-500

- SD-500**  Polished Chrome \$300
- SD-580N**  Satin Nickel \$360





FEATURES AND BENEFITS

Hole Size: 1 1/8"
Weight: 2 lbs.
Capacity: 16 oz.

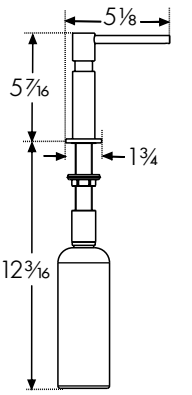
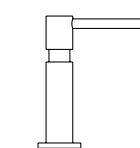
Dispenser Head Detail



Farm House
SD6000

- Limited Quantities Available
- SD6000**  Polished Chrome \$200
 - SD6080**  Satin Nickel \$230



FEATURES AND BENEFITS

Hole Size: 1 1/8"
Weight: 1 lb.
Capacity: 12 oz.

Dispenser Head Detail

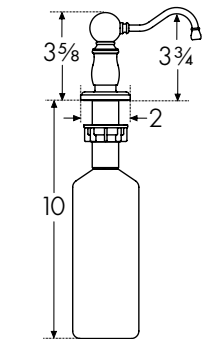
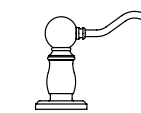

Crystal
SD2600

- SD2600**  Polished Chrome \$205
- SD2680**  Satin Nickel \$240





FEATURES AND BENEFITS

Hole Size: 1 1/8"
Weight: 1 lb.
Capacity: 8.5 oz.

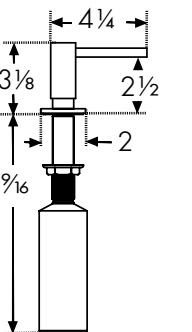
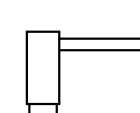
Dispenser Head Detail



Logik
902

- Limited Quantities Available
- 902-C**  Polished Chrome \$150
 - 902-SN**  Satin Nickel \$185



FEATURES AND BENEFITS

Hole Size: 1 1/8"
Weight: 1 lb.
Capacity: 12 oz.

Dispenser Head Detail

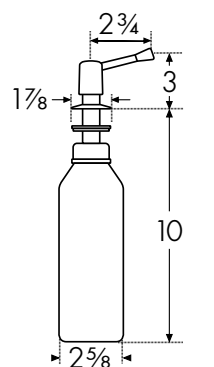
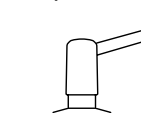

Steel
SD3450SS

- SD3450SS**  Stainless Steel \$250





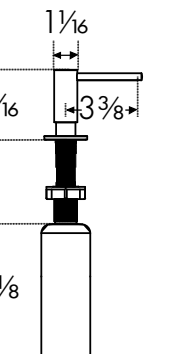
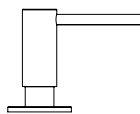

FEATURES AND BENEFITS

Hole Size: 1 1/8"
Weight: 1 lb.
Capacity: 11.5 oz.
316 Stainless Steel

Dispenser Head Detail



Absinthe
SD5200

- SD5200**  Polished Chrome \$150
- SD5220**  Matte Black \$185
- SD5280**  Satin Nickel \$185
- SD5290SB**  Satin Brass \$185



FEATURES AND BENEFITS

Hole Size: 1 1/8"
Weight: 1 lb.
Capacity: 10 oz.

Dispenser Head Detail

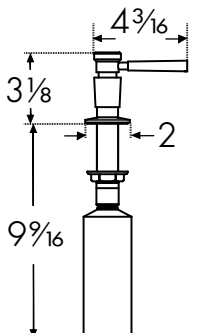
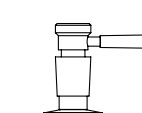

Soap Dispensers

Ambient SD3100

- SD3100 Polished Chrome \$130
- NEW SD3120MBK Matte Black \$165
- SD3180 Satin Nickel \$165



FEATURES AND BENEFITS

Hole Size: 1 1/8"
Weight: 1 lb.
Capacity: 10 oz.

Dispenser Head Detail

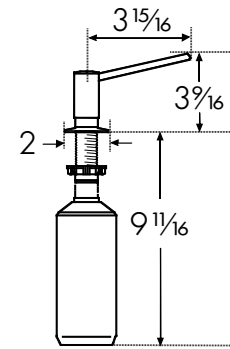
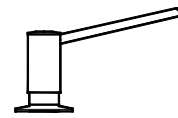

Active SD3200

- SD3200 Polished Chrome \$125
- SD3201 Onyx \$160
- SD3202 Mocha \$160
- SD3203 Storm \$160
- SD3204 Oyster \$160
- SD3205 Champagne \$160
- SD3207 Stone Grey \$160
- SD3220 Matte Black \$160
- SD3222 Shiny Black \$160
- SD3240 Gun Metal \$160
- Limited Quantities Available
- SD3261 Copper \$160
- SD3265 Bronze \$160
- SD3280 Satin Nickel \$160
- SD3290 Satin Brass \$160



FEATURES AND BENEFITS

Hole Size: 1 1/8"
Weight: 1 lb.
Capacity: 10 oz.

Dispenser Head Detail

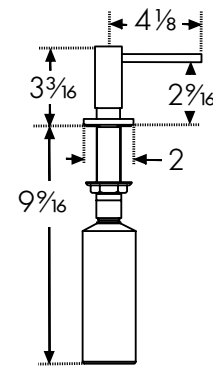
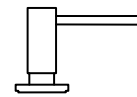

Soap Dispensers

Soap Dispensers



Waste Disposers

Clean up after a big meal has never been so simple with a Franke waste disposer. These **energy efficient** disposers won't leave you second guessing about whether to put food waste in the trash bin or disposal. The disposals come equipped with an **antimicrobial agent, Bio Shield®**, that will reduce odor causing bacteria, and the **Silver Guard®*** feature that offers a magnetic rim to prevent metal objects from falling into the disposer.

*On selected models

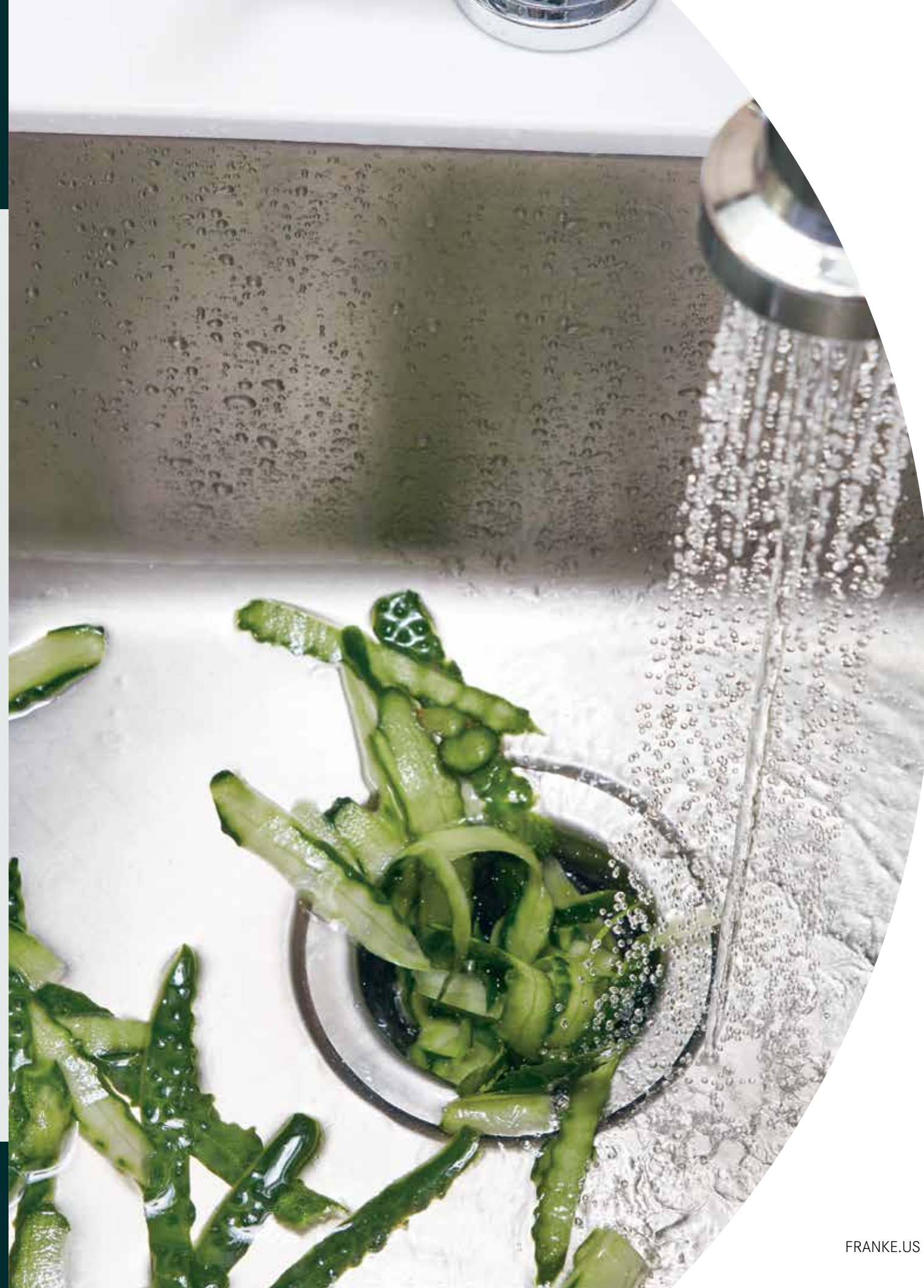

Waste Disposers

Waste Disposers

Specification Guide

| ITEM | WARRANTY | MOTOR TYPE | POWER CORD | SHREDDER BLADE TYPE | SOUND INSULATED SHELL |
|-----------------------------|------------------|---------------------------------------|------------|---------------------|-----------------------|
| FWDJ125 (1 1/4HP) | Limited Lifetime | 2800 rpm Jam-Resistant DC motor | Included | Stainless | Yes |
| FWDJ75B (3/4HP) | 10 Years | 2700 rpm Jam-Resistant DC motor | Included | Stainless | Yes |
| FWDJ75 (3/4HP) | 10 Years | 2700 rpm Jam-Resistant DC motor | Included | Stainless | Yes |
| FWDJ50 (1/2HP) | 5 Years | 2600 rpm Jam-Resistant DC motor | Included | Stainless | Yes |
| WDJ75 (3/4HP) | 5 Years | 2700 rpm Jam-Resistant DC motor | Included | Galvanized | No |
| WDJ75NC (3/4HP) | 5 Years | 2700 rpm Jam-Resistant DC motor | No Cord | Galvanized | No |
| WDJ50 (1/2HP) | 3 Years | 2600 rpm Jam-Resistant DC motor | Included | Galvanized | No |
| WDJ50NC (1/2HP) | 3 Years | 2600 rpm Jam-Resistant DC motor | No Cord | Galvanized | No |
| WDJ33 (1/3HP) | 2 Years | 2400 rpm Jam-Resistant DC motor | Included | Galvanized | No |

Franke waste disposers are  certified Finer grinding for septic system compatibility in ALL models, with no additional chemicals needed.

FWDJ125 \$520

1 1/4 HP Disposer



FEATURES AND BENEFITS

- Horsepower: 1 1/4
- Feed: Continuous
- RPM: 2800
- Silverguard®
- Warranty: Lifetime
- Bio Shield®
- Sound Insulated Shell
- Stainless Steel Grinding Chamber
- Torque Master® Balanced Grinding Systems

19 lbs.

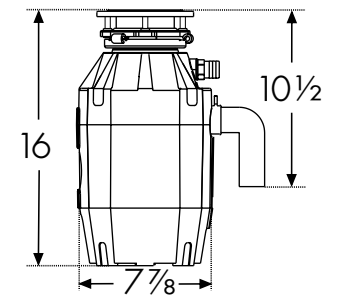

FWDJ75B \$500

3/4 HP Disposer



FEATURES AND BENEFITS

- Horsepower: 3/4
- Feed: Batch
- RPM: 2700
- Warranty: 10 Year
- Bio Shield®
- Sound Insulated Shell
- Stainless Steel Grinding Chamber
- Torque Master® Balanced Grinding Systems

18 lbs.

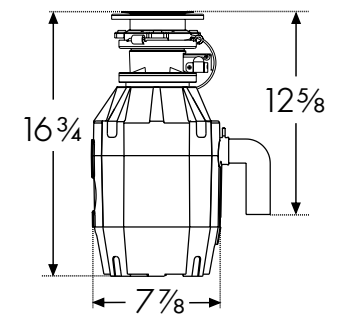

FWDJ75 \$410

3/4 HP Disposer



FEATURES AND BENEFITS

- Horsepower: 3/4
- Feed: Continuous
- RPM: 2700
- Silverguard®
- Warranty: 10 Year
- Bio Shield®
- Sound Insulated Shell
- Stainless Steel Grinding Chamber
- Torque Master® Balanced Grinding Systems

17 lbs.

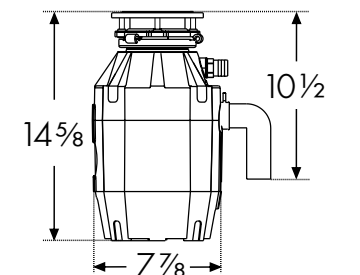

FWDJ50 \$255

1/2 HP Disposer



FEATURES AND BENEFITS

- Horsepower: 1/2
- Feed: Continuous
- RPM: 2600
- Warranty: 5 Year
- Bio Shield®
- Sound Insulated Shell
- Stainless Steel Grinding Chamber
- Torque Master® Balanced Grinding Systems

15 lbs.

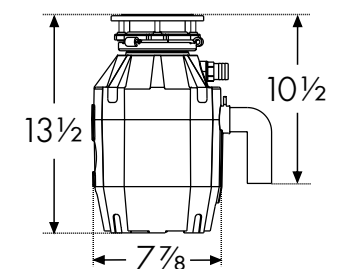

WDJ75 \$305

¾ HP Disposer



FEATURES AND BENEFITS

- Horsepower: ¾
- Feed: Continuous
- RPM: 2700
- Warranty: 5 Year
- Bio Shield®
- Torque Master® Balanced Grinding Systems

13 lbs.

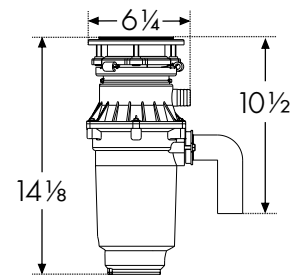

WDJ33 \$180

⅓ HP Disposer



FEATURES AND BENEFITS

- Horsepower: ⅓
- Feed: Continuous
- RPM: 2400
- Warranty: 2 Year
- Bio Shield®
- Torque Master® Balanced Grinding Systems

10 lbs.

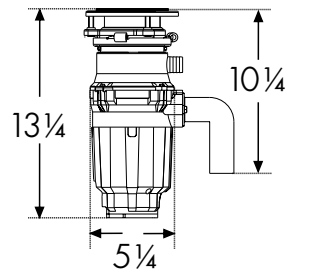

WDJ75NC \$280

¾ HP Disposer
Without Power Cord



FEATURES AND BENEFITS

- Horsepower: ¾
- Feed: Continuous
- RPM: 2700
- Warranty: 5 Year
- Bio Shield®
- Torque Master® Balanced Grinding Systems

13 lbs.

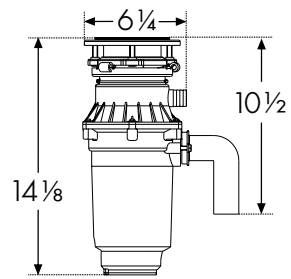

WD9088 \$130

Controller
Requires disposer air switch



FEATURES AND BENEFITS

For continuous feed models
1 lb.

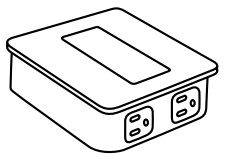

WDJ50 \$215

½ HP Disposer



FEATURES AND BENEFITS

- Horsepower: ½
- Feed: Continuous
- RPM: 2600
- Warranty: 3 Year
- Bio Shield®
- Torque Master® Balanced Grinding Systems

11 lbs.

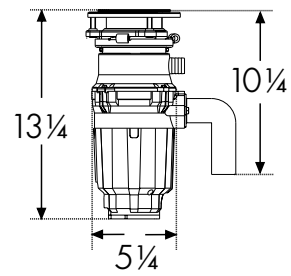

Round Disposer Air Switch

- WD3428C** Polished Chrome \$35
- WD3428SN** Satin Nickel \$35
- WD3428BK** Black \$35



FEATURES AND BENEFITS

For continuous feed models
1 ¾" Diameter
2" Shaft (length)
Fits a 1 ¾" hole
1 lb.
Note: Requires controller WD9088.

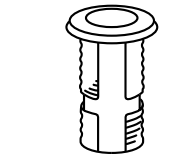

WDJ50NC \$195

½ HP Disposer
Without Power Cord



FEATURES AND BENEFITS

- Horsepower: ½
- Feed: Continuous
- RPM: 2600
- Warranty: 3 Year
- Bio Shield®
- Torque Master® Balanced Grinding Systems

11 lbs.

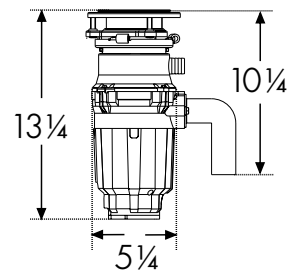

Square Disposer Air Switch

- WD930CH** Polished Chrome \$75
- WD982PN** Polished Nickel \$75
- WD981SN** Satin Nickel \$75
- WD907BLK** Black \$75



FEATURES AND BENEFITS

For continuous feed models
1 13/16" Square
2" Shaft (length)
Fits a 1 1/2" hole
1 lb.
Note: Requires controller WD9088.

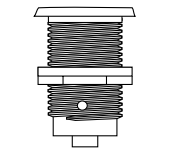

Waste Disposers

Waste Disposers

Extended Waste Disposer Flange
WDFLANGE-EX-SN
WDFLANGE-EX-WH

- Satin Nickel
- White

\$67
 \$65

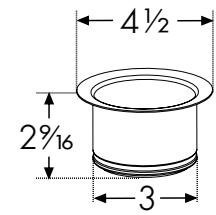

FEATURES
AND BENEFITS

Hole Size: 3 1/2"
 4 oz.
 Stopper not Included. Use stopper
 provided with the waste disposer.

Waste Disposer Flange
WDFLANGE-SS
WDFLANGE-CH
WDFLANGE-BK

- Stainless Steel
- Polished Chrome
- Black

\$65
 \$65
 \$69

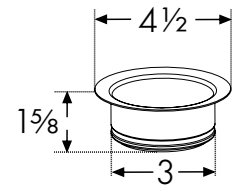

FEATURES
AND BENEFITS

Hole Size: 3 1/2"
 3.5 oz.
 Stopper Included



Waste Disposers

Waste Disposers



Accessories

Franke offers everything for the kitchen sink. **Customize your work space** with our accessories, including strainers, waste kits, drain covers and roller mats.

Universal Roller Mat
UV-36RM

Stainless Steel

\$175

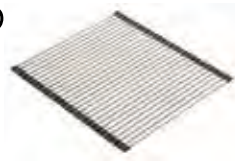

FEATURES AND BENEFITS

- 2 lbs.
- Use over sink or on counter
- Compatible with most sinks
- Holds up to 40 lbs.
- For use as dish drainer or trivet
- 18⁷/₁₆" x 20"
- Dishwasher safe

Strainer Basket
906

Polished Chrome

\$70



FEATURES AND BENEFITS

1 lb.
Standard 3¹/₂" waste hole

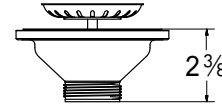

906SN

Satin Nickel

\$95

Strainer Basket
900W

White

\$60



FEATURES AND BENEFITS

1 lb.
Standard 3¹/₂" waste hole

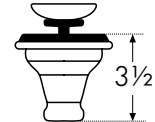

Deep Drain Waste Kit
906D-SN

Satin Nickel

\$160



FEATURES AND BENEFITS

1 lb.
Includes strainer basket and compost cup

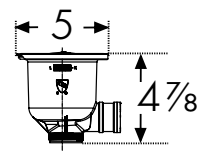

Air Gap

AG100

Polished Chrome

\$55

AG180

Satin Nickel

\$65

AG120

Matte Black

\$65

AG122

Shiny Black

\$65

AG140

Gun Metal

\$65

AG150

Stainless Steel

\$65

AG161

Copper

\$65

AG165

Bronze

\$65

AG190

Satin Brass

\$65



FEATURES AND BENEFITS

1 lb.
Hole Size: 1¹/₄"

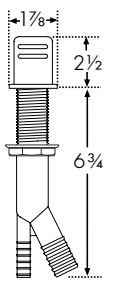

Peak Drain Cover
PKXCVR

Stainless Steel

\$105

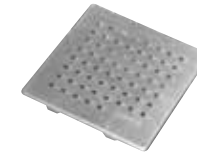

FEATURES AND BENEFITS

1 lb.
4⁷/₈" x 4⁷/₈"
Feet are coated

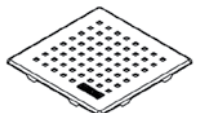

Square drain cover
PKGCVR

Stainless Steel

\$90



FEATURES AND BENEFITS

1 lb.
4⁷/₈" x 4⁷/₈"
Feet are coated

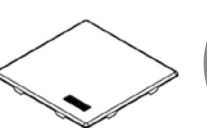

Round Drain Cover
RNDCVR

Stainless Steel

\$90



FEATURES AND BENEFITS

1 lb.
4¹/₂"
Feet are coated

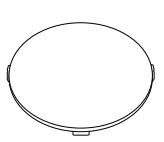

Push Button Strainer Kit

906P-C Polished Chrome \$135

906P-SN Satin Nickel \$160



FEATURES AND BENEFITS

1 lb.
Hole size: 1 3/8"
MAX. 2 1/2" countertop thickness
Flange diameter 1 3/4"
Cable length 19"
Standard 3 1/2" waste hole
Only compatible with stainless steel sinks

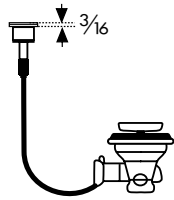

Pop-up Strainer

900P Polished Chrome \$125

900P-SN27 Satin Nickel \$150



FEATURES AND BENEFITS

1 lb.
Hole size: 1"
MAX. 2 1/2" countertop thickness
Flange diameter 1 1/2"
Cable length 27"
Standard 3 1/2" waste hole
Not compatible with fireclay sinks

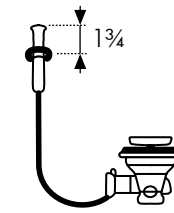

Remote Twist Waste Kit

FRTWIST-SN Satin Nickel \$170



FEATURES AND BENEFITS

1 lb.
Hole size: 1 3/8"
MAX. 2 1/2" countertop thickness
Flange diameter 1 3/4"
Cable length 19"
Standard 3 1/2" waste hole
Only compatible with stainless steel sinks

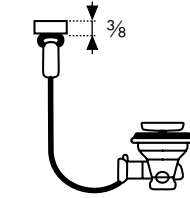

Inox Cream

903 \$35



FEATURES AND BENEFITS

Stainless steel cleaner
• Restores sheen and brightness
• Easy to use
• 250 ml

Faucet Hole Cover

628 Polished Chrome \$9

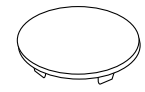

| | MODEL NO. | BOTTOM GRID | CUTTING MAT | CUTTING BOARD | CUTTING BOARD | COLANDER | DRAIN BOARD | ROLLER MAT | KNIFE SET | WIRE RACK | FRAME COVER | POP-UP STRAINER | DRAIN COVER | PAGE NO. |
|-------------|----------------|---------------------------|------------------------|-----------------------------------|----------------------|-------------------------|-------------------------|-------------------------------------|-----------|-----------|-------------|-----------------------------------|---|------------------------|
| CHEF CENTER | CUX11018-W | CUW18-36S Included | SP-40S Included | CUW-40S Included | | CUW-70S Included | CUW-60S Included | CUW-36RM Included | | | | 906P-C 906P-SN Included | PKGCVR Included | 26 |
| | CUX11024-W | CUW24-36S Included | SP-40S Included | CUW-40S Included | | CUW-70S Included | CUW-60S Included | CUW-36RM Included | | | | 906P-C 906P-SN Included | PKGCVR Included | 26 |
| | CUX11031-W | CUW31-36S Included | SP-40S Included | CUW-40S Included | | CUW-70S Included | CUW-60S Included | CUW-36RM Included | | | | | 906P-C 906P-SN Included | PKGCVR Included |
| CRYSTAL | CLV110-24 | CL-24-36S | | | PS2-45S | PE-70S | | RM18S | | | | | CL-WGC CL-SSC CL-BGC Included | 50 |
| | CLV110-28 | CL-28-36S | | | PS2-45S | PE-70S | | RM18S | | | | | CL-WGC CL-SSC CL-BGC Included | 50 |
| | CLV110-31 | CL-31-36S | | | PS2-45S | PE-70S | | RM18S | | | | | CL-WGC CL-SSC CL-BGC Included | 50 |
| | CLV120-33 | CL-14-36S | | | PS2-45S | PE-70S | | RM18S | | | | | CL-WGC CL-SSC CL-BGC Included | 51 |
| CUBE | CUX11010-W | | SP-40S | CU-40S CU-40K CU-GC | CU-40P CU-40P | CUW-70S | | CU-KS CU-WR CU-FC | | | | | | 78 |
| | CUX11015 | CU15-36S | | CU-40S | CU-40P | CUW-70S | | | | | | 906P-C 906P-SN | | 78 |
| | CUX11019 | CU19-36S | | CU-40S | CU-40P | CUW-70S | | | | | | 906P-C 906P-SN | | 78 |
| | CUX11021 | CU21-36S | | CU-40S | CU-40P | CUW-70S | | | | | | 906P-C 906P-SN | | 79 |
| | CUX11023 | CU23-36S | | CU-40S | CU-40P | CUW-70S | | | | | | 906P-C 906P-SN | | 80 |
| | CUX11025 | CU25-36S | | CU-40S | CU-40P | CUW-70S | | | | | | 906P-C 906P-SN | | 80 |
| | CUX11025-8 | CU25-8-36S | | CU-40S | CU-40P | CUW-70S | | | | | | 906P-C 906P-SN | | 80 |
| | CUX11027 | CU27-36S | | CU-40S | CU-40P | CUW-70S | | | | | | 906P-C 906P-SN | | 81 |
| | CUX11027-8 | CU27-8-36S | | CU-40S | CU-40P | CUW-70S | | | | | | 906P-C 906P-SN | | 81 |

| | MODEL NO. | BOTTOM GRID | CUTTING MAT | CUTTING BOARD | CUTTING BOARD | COLANDER | ROLLER MAT | KNIFE SET | WIRE RACK | FRAME COVER | DRAIN COVER | POP-UP STRAINER | PAGE NO. | |
|-----------------|------------------|------------------------------|-------------|-----------------------------------|-----------------------------------|-------------|-------------|-------------------------------------|-----------|-------------|-------------|------------------------|-----------------------|----|
| CUBE | CUX11030 | CU30-36S | | CU-40S | CU-40P | CUW-70S | UV-36RM | | | | | 906P-C 906P-SN | 82 | |
| | CUX11030-8 | CU30-8-36S | | CU-40S | CU-40P | CUW-70S | UV-36RM | | | | | 906P-C 906P-SN | 82 | |
| | CUX120 | CU15-36S | | CU-40S | CU-40P | CUW-70S | UV-36RM | | | | | 906P-C 906P-SN | 83 | |
| | CUX160 | CU18-36S CU11-36S | | CU-40S | CU-40P | CUW-70S | UV-36RM | | | | | 906P-C 906P-SN | 83 | |
| | CUX16024 | CU10-36S CU13-36S | | CU-40S | CU-40P | CUW-70S | UV-36RM | | | | | 906P-C 906P-SN | 82 | |
| | CUX16032 | CU13-36S CU17-36S | | CU-40S | CU-40P | CUW-70S | UV-36RM | | | | | 906P-C 906P-SN | 84 | |
| CULINARY CENTER | CUX11021-ADA | CU21-36S | | CU-40S | CU-40P | CUW-70S | UV-36RM | | | | | 906P-C 906P-SN | 84 | |
| | CUX11027-ADA | CU27-36S | | CU-40S | CU-40P | CUW-70S | UV-36RM | | | | | 906P-C 906P-SN | 84 | |
| | CUX11010-W | | SP-40S | CU-40S CU-40K CU-GC | CU-40P CU-40P | CUW-70S | | CU-KS CU-WR CU-FC | | | | | | 21 |
| | CUX16021-W | CU21-36S | SP-40S | CU-40S | CU-40P CU-40K CU-GC | CUW-70S | | CU-KS CU-WR CU-FC | | | | RNDCVR Included | | 21 |
| | GDX11012 | GD12-36S | | | | | UV-36RM | | | | | | 900P 900P-SN27 | 90 |
| | GDX11015 | GD15-36S | | | | | UV-36RM | | | | | | 900P 900P-SN27 | 90 |
| | GDX11018 | GD18-36S | | | | | | | | | | | 900P 900P-SN27 | 90 |

Quick Reference

Quick Reference

| | MODEL NO. | BOTTOM GRID | SHELF GRID | CUTTING BOARD | COLANDER | WIRE BASKET | ROLLER MAT | TWIST WASTE KIT | POP-UP STRAINER | DRAIN COVER | PAGE NO. | |
|----------------|-----------------|-------------|------------|---------------|----------|-------------|------------|-----------------|-------------------|---------------------|----------|----|
| GRANDE | GDX11023 | GD23-36S | | GD-40S | | | UV-36RM | | 900P 900P-SN27 | | 91 | |
| | GDX11028 | GD28-36S | | GD28-40S | | | UV-36RM | | 900P 900P-SN27 | | 91 | |
| | GDX11031 | GD31-36S | | GD-40S | | | UV-36RM | | 900P 900P-SN27 | | 92 | |
| | GDX12031 | GD15-36S | | GD-40S | | | UV-36RM | | 900P 900P-SN27 | | 92 | |
| | GDX16028RH | GD12-36S | | GD-40S | | | UV-36RM | | 900P 900P-SN27 | | 92 | |
| | | GD15-36S | | | | | | | | | | 92 |
| | GDX16031RH | NC12-36S | | GD-40S | | | UV-36RM | | 900P 900P-SN27 | | | 93 |
| | NC18-36S | | | | | | | | | | | |
| MANOR HOUSE | MHX710-30 | MH30-36S | | OA-40S | | | | FRTWIST-SN | | | 14 | |
| | MHX710-33 | MH33-36S | | OA-40S | | | | FRTWIST-SN | | | 14 | |
| | MHX710-36 | MH36-36S | | OA-40S | | | | FRTWIST-SN | | | 14 | |
| ORCA 2.0 | OR2X110 | OC2-36S | OC2-31S-RH | OC2-45SP | OC2-60S | OC2-50C | | | | RNDVCVR Included | 65 | |
| | ODX110-2310-316 | PS23-36S | | | | | | | | | 102 | |
| OUTDOOR SERIES | ODX110-2312-316 | PS23-36S | | | | | | | | | 102 | |
| | | | | | | | | | | | | |
| PEAK | PKX1108 | | | | PX-70S | UV-36RM | | FRTWIST-SN | | PKXCVR Included | 32 | |
| | PKX11013 | PX-13S | PX-13S | | PX-70S | UV-36RM | | FRTWIST-SN | | PKXCVR Included | 32 | |
| | PKX11016 | PX-16S | PX-16S | PX-40S | PX-70S | UV-36RM | | FRTWIST-SN | | PKXCVR Included | 32 | |

| | MODEL NO. | BOTTOM GRID | SHELF GRID | CUTTING MAT | CUTTING BOARD | CUTTING BOARD | COLANDER | ROLLER MAT | TWIST WASTE KIT | POP-UP STRAINER | DRAIN COVER | PAGE NO. |
|-----------|-----------|-------------|------------|-------------|---------------|---------------|----------|------------|-------------------|--------------------|----------------------|----------|
| PEAK | PKX11018 | PX-18S | PX-18S | | | PX-40S | PX-70S | UV-36RM | FRTWIST-SN | | PKXCVR Included | 33 |
| | PKX11021 | PX-21S | PX-21S | | | PX-40S | PX-70S | UV-36RM | FRTWIST-SN | | PKXCVR Included | 33 |
| | PKX11025 | PX-25S | PX-25S | | | PX-40S | PX-70S | UV-36RM | FRTWIST-SN | | PKXCVR Included | 34 |
| | PKX11028 | PX-28S | PX-28S | | | PX-40S | PX-70S | UV-36RM | FRTWIST-SN | | PKXCVR Included | 34 |
| | PKX160 | PX-21S | PX-21S | | | PX-40S | PX-70S | UV-36RM | FRTWIST-SN | | PKXCVR 2 Included | 34 |
| | PTX110-14 | PT14-36S | | SP-40S | PT-40S | PT-41S | PE-70S | UV-36RM | | 906P-C 906P-SN | PKGCVR Included | 56 |
| | PTX110-17 | PT17-36S | PT14-31S | SP-40S | PT-40S | PT-41S | PE-70S | UV-36RM | | 906P-C 906P-SN | PKGCVR Included | 56 |
| PTX110-20 | PT20-36S | PT14-31S | SP-40S | PT-40S | PT-41S | PE-70S | UV-36RM | | 906P-C 906P-SN | PKGCVR Included | 56 | |
| PTX110-22 | PT22-36S | PT14-31S | SP-40S | PT-40S | PT-41S | PE-70S | UV-36RM | | 906P-C 906P-SN | PKGCVR Included | 57 | |
| PTX110-25 | PT25-36S | PT14-31S | SP-40S | PT-40S | PT-41S | PE-70S | UV-36RM | | 906P-C 906P-SN | PKGCVR Included | 57 | |
| PTX110-28 | PT28-36S | PT14-31S | SP-40S | PT-40S | PT-41S | PE-70S | UV-36RM | | 906P-C 906P-SN | PKGCVR Included | 58 | |
| PTX110-31 | PT31-36S | PT14-31S | SP-40S | PT-40S | PT-41S | PE-70S | UV-36RM | | 906P-C 906P-SN | PKGCVR Included | 58 | |
| PTX160-31 | PT14-36S | PT14-31S | SP-40S | PT-40S | PT-41S | PE-70S | UV-36RM | | 906P-C 906P-SN | PKGCVR Included | 58 | |
| PTX160-37 | PT14-36S | PT14-31S | SP-40S | PT-40S | PT-41S | PE-70S | UV-36RM | | 906P-C 906P-SN | PKGCVR Included | 59 | |

Quick Reference

Quick Reference



| | MODEL NO. | BOTTOM GRID | SHELF GRID | CUTTING MAT | CUTTING BOARD | CUTTING BOARD | COLANDER | ROLLER MAT | POP-UP STRAINER | DRAIN COVER | PAGE NO. |
|------------------|---------------|----------------------|------------|-------------|---------------|---------------|----------|------------|-------------------|----------------------|----------|
| PESCARA | PTX160-40 | PT17-36S PT22-36S | PT14-31S | SP-40S | PT-40S | PT-41S | PE-70S | UV-36RM | 906P-C 906P-SN | PKGCVR 2 Included | 59 |
| | PCX1102109 | PR-36S | | | | | | UV-36RM | 900P 900P-SN27 | | 69 |
| PRESTIGE | PRX11021 | PR-36S | PR-31S | | | | | UV-36RM | 900P 900P-SN27 | | 69 |
| PROFESSIONAL 2.0 | PS2X110-15 | PS2-15-36S | | | | PS2-45S | PE-70S | RM18S | | RNDCVR Included | 40 |
| | PS2X110-18 | PS2-18-36S | | | | PS2-45S | PE-70S | RM18S | | RNDCVR Included | 40 |
| | PS2X110-21 | PS2-21-36S | | | | PS2-45S | PE-70S | RM18S | | RNDCVR Included | 40 |
| | PS2X110-24 | PS2-24-36S | | | | PS2-45S | PE-70S | RM18S | | RNDCVR Included | 41 |
| | PS2X110-24-12 | PS2-24-36S | | | | PS2-45S | PE-70S | RM18S | | RNDCVR Included | 41 |
| | PS2X110-27 | PS2-27-36S | | | | PS2-45S | PE-70S | RM18S | | RNDCVR Included | 42 |
| | PS2X110-30 | PS2-30-36S | | | | PS2-45S | PE-70S | RM18S | | RNDCVR Included | 42 |
| | PS2X110-30-12 | PS2-30-36S | | | | PS2-45S | PE-70S | RM18S | | RNDCVR Included | 42 |
| | PS2X110-33 | PS2-33-36S | | | | PS2-45S | PE-70S | RM18S | | RNDCVR Included | 43 |















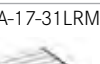

| | MODEL NO. | BOTTOM GRID | CUTTING BOARD | COLANDER | DRAIN BASKET | ROLLER MAT | POP-UP STRAINER | DRAIN COVER | PAGE NO. |
|------------------|---------------|--------------------------|---------------|----------|--------------|------------|-------------------|----------------------|----------|
| PROFESSIONAL 2.0 | PS2X160-18-11 | PS2-11-36S PS2-18-36S | PS2-45S | PE-70S | | RM18S | | RNDCVR 2 Included | 43 |
| | PS2X120-14-14 | PS2-14-36S | PS2-45S | PE-70S | | RM18S | | RNDCVR 2 Included | 44 |
| | PS2X120-16-16 | PS2-16-36S | PS2-45S | PE-70S | | RM18S | | RNDCVR 2 Included | 44 |
| REGATTA | RGX160 | RG-36S RG-36S-RH | | | CP-50C | UV-36RM | 900P 900P-SN27 | | 73 |
| ROTONDO | RBX-110 | | | | | UV-36RM | 900P 900P-SN27 | | 97 |

Quick Reference

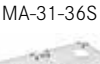
Quick Reference

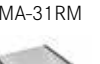
| | MODEL NO. | BOTTOM GRID | SHELF GRID | CUTTING BOARD | ROLLER MAT | PAGE NO. |
|-------------|--|--|--|---|--|----------|
| CISTERNA | CCK110-13  | CK13-36C  | | OA-40S  | UV-36RM  | 132 |
| | CCK110-15  | CK15-36C  | | OA-40S  | UV-36RM  | 132 |
| | CCK110-19  | CK19-36C  | | OA-40S  | UV-36RM  | 132 |
| FARM HOUSE | FHK710-30  | FK30-36S  | | OA-40S  | | 112 |
| | FHK710-33  | FK33-36S  | | OA-40S  | | 112 |
| | FHK710-36  | FK36-36S  | | OA-40S  | | 112 |
| MANOR HOUSE | MHK110-20  | | | OA-40S  | | 118 |
| | MHK110-24  | MK24-36C  | | OA-40S  | | 118 |
| | MHK110-28  | MK28-36C  | | OA-40S  | | 118 |
| | MHK720-31  | MK31-36C-LH  MK31-36C-RH  | | OA-40S  | | 119 |
| | MHK720-35  | MK35-36C-LH  MK35-36C-RH  | | OA-40S  | | 119 |
| ORCA | ORK110  | OK-36C  | OK-31C-LH  OK-31C-RH  | OA-40S  | UV-36RM  | 123 |
| PRESTIGE | PRK11021  | PK21-36S  | PK21-31S  | OA-40S  | UV-36RM  | 127 |

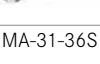
| | MODEL NO. | BOTTOM GRID | ROLLER MAT | PAGE NO. |
|---------|---|--|--|----------|
| ELLIPSE | ELG11022*  | ELG22-36S  | UV-36RM  | 168 |
| | ELG120*  | ELG14-36S  | UV-36RM  | 168 |
| | ELG160*  | ELG16-36S  ELG13-36S  | UV-36RM  | 169 |
| | ESOX25229-1*  | FBGG1914  | | 170 |
| | EDOX33229-1*  | FBGG1114  | | 170 |
| | EOOX33229-1*  | FBGG1014  FBGG1316  | | 171 |
| GRAVITY | SGR3322-1*  | FBGG2716  | | 179 |
| | DIG62F91*  | BGDIL150  BGDIS150  | | 179 |

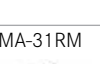
| | MODEL NO. | BOTTOM GRID | COLANDER | CUTTING BOARD | ROLLER MAT | PAGE NO. |
|-------|--|--|---|---|--|----------|
| KUBUS | KBG11013*  | KBG13-36S  | | | UV-36RM  | 163 |
| | KBG11031*  | KBG31-36S  | | | UV-36RM  | 163 |
| MARIS | MAG61023*  | | MA-70S  | | MA-17-31LRM  | 158 |
| | MAG610310W*  | MA-31-36S  | MA-70S  | MA-40S  | MA-31RM  | 158 |
| | MAG110310W*  | MA-31-36S  | MA-70S  | MA-40S  | MA-31RM  | 159 |

*Reference corresponding pages for all available color options.

Quick Reference

Quick Reference

| | MODEL NO. | BOTTOM GRID | BOTTOM ROLLER MAT | COLANDER | SHELF ROLLER MAT | CUTTING BOARD | DRAIN COVER | PAGE NO. |
|---------|------------|------------------------|--------------------------|----------|------------------|---------------|--------------------|----------|
| PEAK | PKG11014* | | PKG14-36RM | | PKG14-31RM | PG2-40S | PKGCVR Included | 142 |
| | PKG11020* | | PKG20-36RM | | PKG14-31RM | PG2-40S | PKGCVR Included | 142 |
| | PKG11031* | PKG31-36S | PKG31-36RM | | PKG18-31RM | PG-40S | PKGCVR Included | 143 |
| | PKG160* | PKG17-36S PKG12-36S | PKG17-36RM PKG12-36RM | | PKG18-31RM | PG-40S | PKGCVR Included | 144 |
| PRIMO | DIG61091* | BGD1110 | | | | | | 175 |
| | DIG62D91* | BGD1100 | | | | | | 175 |
| QUANTUM | SOX1720-1* | FBG180S | | | | | | 183 |
| URBAN | UBG110-20* | BG400S | | PX-70S | | UG-40S | | 150 |
| | UBG110-28* | BG410S | | PX-70S | | UG-40S | | 150 |
| | UBG120-28* | BG430S BG440S | | PX-70S | | UG-40S | | 151 |
| | | UBG120-32* | BG450S BG430S | | PX-70S | | UG-40S | |

| | | | | | | | | |
|-----|--|---|--|---|--|---|--|--|
| 12" |  PKX1108 Page 32 | | | | | | | |
| 18" |  CCK110-13 Page 132 |  CUX11010-W Page 21 & 78 |  GDX11012 Page 90 |  PKX11013 Page 32 |  PTX110-14 Page 56 |  RBX-110 (Topmount) Page 97 |  SOX1720-1 SZGR1720-1 SZGH1720-1 SZPW1720-1 Page 183 | |
| 21" |  CCK110-15 Page 132 |  CUX11015 Page 78 |  GDX11015 Page 90 |  KBG11013 Page 163 |  MHK110-20 Page 118 | | | |
| |  PKG11014 Page 142 |  PKX11016 Page 32 |  PS2X110-15 Page 40 |  PTX110-17 Page 56 |  RBX-110 (Undermount) Page 97 | | | |
| 24" |  CUX11019 Page 78 |  GDX11018 Page 90 |  MHK110-24 Page 118 |  PKX11018 Page 33 |  PS2X110-18 Page 40 |  PTX110-20 Page 56 | | |
| 27" |  CCK110-19 Page 132 |  CUX11021 Page 79 |  CUX11021-ADA Page 84 |  ELG11022 Page 168 |  ESOX25229-1 ESDB25229-1 ESCH25229-1 Page 170 |  MAG61023 Page 158 |  PCX1102109 Page 69 | |
| |  PKG11020 Page 142 |  PKX11021 Page 33 |  PRK11021 Page 127 |  PRX11021 Page 69 |  PS2X110-21 Page 40 |  PTX110-22 Page 57 |  UBG110-20 Page 150 | |

*Reference corresponding pages for all available color options.

Quick Reference

Quick Reference

Minimum Cabinet Size

30"



33"



36"



Minimum Cabinet Size

36"



39"



42"

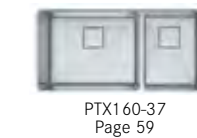

45"



Quick Reference

Quick Reference

Side Spray Faucets

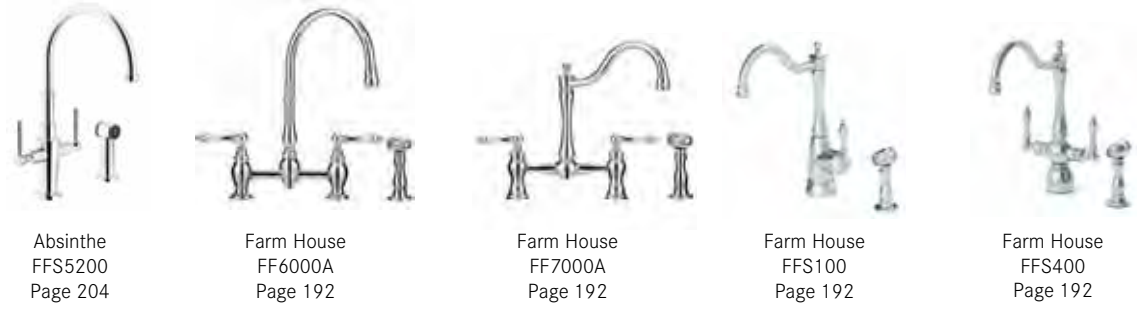

Pull-Out Faucets

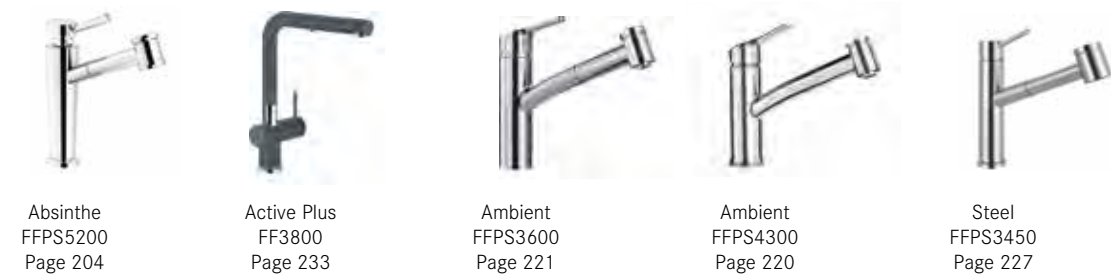

Pull-Down Faucets



Professional Faucets



Prep Faucets



Quick Reference

Quick Reference

Bar Faucets



Absinthe FFB5200 Page 205
 Ambient FFB3100 Page 220
 Cube FFB3350 Page 239
 Kubus FFB4250 Page 235
 Steel FFB3450 Page 226

Pot Fillers



Absinthe PF5200 Page 204
 Ambient PF3100 Page 221
 Farm House PF3300 Page 193
 Farm House PF7000A Page 193
 Pescara PF4400 Page 213
 Pescara PFD4400 Page 213
 Steel PF3450 Page 227

3-in-1 Filtration Faucets



Absinthe FFT5200 Page 205 & 242
 Ambient FFT3100 Page 1221 & 242
 Cube FFT3350 Page 239 & 242
 Professional FFPD5400 Page 199

Cold Filtration Faucets



Absinthe DW15000 Page 205 & 245
 Ambient DW10000 Page 222 & 247
 Ambient DW7000C Page 221 & 246
 Farm House DW12000 Page 194 & 243
 Farm House DW6100C Page 193 & 242
 Logik DW9000C Page 244
 Pescara DW16000 Page 214 & 245
 Steel DW13050 Page 227 & 248

Hot Filtration Faucets



Absinthe LB15100 Page 206 & 245
 Ambient LB10100 Page 222 & 247
 Ambient LB7100C Page 222 & 247
 Farm House LB12100 Page 194 & 243
 Farm House LB6100C Page 194 & 243
 Logik LB9100C Page 244
 Pescara LB16100 Page 214 & 246
 Steel LB13150 Page 227 & 248

Hot/Cold Filtration Faucets



Absinthe LB15200 Page 1206 & 245
 Ambient LB10200 Page 223 & 248
 Ambient LB7200C Page 222 & 247
 Farm House LB12200 Page 195 & 244
 Farm House LB6200C Page 194 & 243
 Logik LB9200C Page 244
 Pescara LB16200 Page 214 & 246
 Steel LB13250 Page 228 & 248

Soap Dispenser Guide



Absinthe SD5200 Page 206 & 257
 Active SD3200 Page 233 & 258
 Ambient SD3100 Page 223 & 258
 Crystal SD2600 Page 201 & 256
 Farm House SD6000 Page 195 & 257
 Logik 902 Page 257
 Square SD-800 Page 256
 Steel SD3450 Page 228 & 256
 Twin SD-500 Page 256

Quick Reference

Quick Reference

GENERAL

- Products may only be sold and advertised within the United States of America. Franke hereby expressly prohibits the dealer from soliciting or consummating sales outside of the United States of America without prior written consent.
- Products shall only be sold in their original packaging. Relabeling, repackaging (including the separation of bundled products or the bundling of separate products), and other alterations are not permitted.
- Sale of Franke products on the Internet shall be prohibited unless resellers apply and are approved by Franke Kitchen Systems, LLC, and execute an Authorized Internet Reseller Agreement regulating the manner in which they sell online.

ORDERING

- Once an order has been acknowledged, no changes (including additions or cancellations) will be accepted.
- Order acknowledgments are available via email. An email address must be provided to receive this benefit.
- Standard lead time for shipment is one to five (1-5) business days from receipt of order.

STANDARD PAYMENT TERMS

- Net 30 days.
- Early payment discounts are not applicable for payments via credit card.
- Franke reserves the right to charge interest and an administration fee on late payments.

PRICING

- Please refer to the electronically published price list (EPL). Orders will be priced with the prevailing price at the time the order is placed.
- Prices are subject to change without notice. Franke will attempt to provide reasonable lead time for pricing changes.

CLAIMS / CHARGE BACKS

- Damages/Shortages must be reported within ten (10) days of receipt of merchandise.
- Charge backs will not be accepted without an authorization number (RMA), provided by a Regional Sales Manager, Distributor, or Customer Service.

RETURNS

- No returns will be accepted without a return authorization number (RMA).
- Return authorization requests must be submitted through Rep/Regional Manager.
- A 25% restocking fee will be charged for ALL returns of product that was not damaged or mis-shipped.
- No returns will be accepted more than 180 days from original invoice date.
- No returns will be accepted on discontinued (DWO) or obsolete product.
- Franke reserves the right to refuse returns without reason.

FREIGHT

- Pre-paid freight/Free freight allowance (FFA)
 - USD 2,900 is the minimum order value for FFA
 - All product lines, including parts, can be included in freight qualification calculations.
 - All Display and Literature orders will be shipped with pre-paid freight status.
- Flat Rate Shipping
 - Any order shipping parcel containing standard products will ship for \$25 flat.
 - Orders >150 lbs. are shipping LTL and are charged according to weight/dimension.
 - Orders containing Fireclay sinks are charged USD 150 for up to 2 units and USD 300 for up to 4 units.
 - Other: standard shipping rates apply for Fireclay orders greater than 4 units and any parts only orders.
 - Franke reserves the right to modify these terms at any time.

- Other freights terms
 - Franke will attempt to fulfill requests to expedite shipping. Customers will be responsible for additional freight charges. Contact Customer Service for all expedited shipping requests.
 - Drop shipment of internet orders is not available. All Internet Sales must be shipped from an Authorized Internet Reseller's location. Drop shipment is offered within 100 miles of customer's place of business, or within customer's state or a bordering state.

BACK ORDERS

- Back order shipments will match freight qualifying status of original order.
- Back ordered product will be considered an active order unless customer requests cancellation.

LIMITED WARRANTY**SINKS**

Franke warrants that each Franke sink will be free from manufacturing defects in material and workmanship for the lifetime of the sink.

FAUCETS

Franke warrants that mechanical parts in all faucets purchased after January 1, 2003 will be free of manufacturing defects in material and workmanship for the lifetime of the faucet. Faucets purchased prior to 2003 are subject to the warranty in place at time of purchase. Franke warrants that (1) the chrome finishes on Franke faucets will be free of manufacturing defect for the lifetime of the faucet; and (2) all other finishes on Franke faucets will be free of manufacturing defect for five (5) years from the original date of purchase.

WATER DISPENSING & FILTRATION SYSTEMS

Franke warrants that Franke water dispensing and filtration systems are free from manufacturing defects in material and workmanship for the period set forth in the paperwork included with the product, which is 5 or 10 years from the date of purchase, depending on the model purchased.

HOT WATER TANKS

Franke warrants that Franke hot water tanks are free from manufacturing defects in material and workmanship for the period set forth in the paperwork included with the product, which is 1 or 3 years from the date of purchase, depending on the model purchased.

WASTE DISPOSERS

Franke warrants that Franke 1/2 Horsepower disposer models are free from manufacturing defects in material and workmanship for the period set forth in the paperwork included with the product, which is 3 or 5 years from the date of purchase, depending on the model purchased. Franke warrants that Franke 3/4 horsepower waste disposers are free from manufacturing defects for the period set forth in the paperwork included with the product, which is 5 or 10 years from the date of purchase, depending on the model purchased. Franke warrants that Franke 1-1/4 horsepower models are free from manufacturing defects in material and workmanship for the lifetime of the product.

LOTION/SOAP DISPENSERS

Franke warrants that Franke lotion/soap dispensers are free from manufacturing defects in material and workmanship for a period of five years from the date of purchase. Such warranty does not cover damage caused by the use of aggressive soaps and lotions.

ACCESSORIES

Franke warrants that Franke accessories, including, but not limited to, shelves, colanders, strainers, cutting boards and other accessory items, are free from manufacturing defects in material and workmanship for a period of one (1) year from the date of purchase.

OUTDOOR INSTALLATION

Franke Soap dispensers, waste disposers, water dispensing systems and accessories are NOT warranted for outdoor installations. Certain Franke faucets are warranted to be free from manufacturing defects in material and workmanship for outdoor installations for the period set forth in the paperwork included with the product, which is 5 or 10 years from the date of purchase, depending on the model purchased.

WARRANTY TERMS

Each warranty by Franke Kitchen System, LLC (“Franke”) set forth herein (each, a “Warranty” and collectively the “Warranties”) applies only to the original owner when purchased from Franke or a Franke, authorized reseller. The Warranties only apply if the applicable product has been installed in accordance with our installation instructions, used as recommended and in a normal residential application. To make a warranty claim, the owner must provide proof of purchase, in the form of a sales receipt. Each Warranty covers all components that make the applicable product operational. Franke, at its option, may repair or replace the product or components necessary to restore the product to good working condition. Franke reserves the right to inspect the installation prior to the actual replacement of the product or component part. The Warranties do not cover any product used in combination with a Reverse Osmosis Filtration System.

The Warranties do not cover misuse or abuse, accidental damages, scuffs or scratches, improper installation, abnormal usage, negligence, damage caused by improper maintenance or cleaning or normal wear. Damage caused by impurities or acts beyond Franke’s control are not covered by any Warranty. Further, this warranty does not cover any products purchased from unauthorized dealers. If any product or part has been repaired or altered in any manner outside of Franke’s factory, unless previously authorized in writing by Franke, the applicable Warranty is void with respect to such product or part. Owner of a product will be liable for any transportation and re-installation costs related to any Warranty for such product. The Warranties do not allow recovery of incidental or consequential damages such as loss of use, delay, property damage or other consequential damage, and Franke accepts no liability for such damages.

Each Warranty is limited to the conditions set forth herein and to the applicable warranty period specified herein and is exclusive. EXCEPT FOR THE WARRANTIES SET FORTH HEREIN, FRANKE MAKES NO WARRANTY WHATSOEVER WITH RESPECT TO THE PRODUCTS, INCLUDING, BUT NOT LIMITED TO, (1) ANY WARRANTY OF MERCHANTABILITY, (2) WARRANTY OF FITNESS FOR A PARTICULAR PURPOSE, (3) WARRANTY OF TITLE, OR (4) WARRANTY AGAINST INFRINGEMENT OF INTELLECTUAL PROPERTY RIGHTS OF A THIRD PARTY, WHETHER EXPRESS OR IMPLIED BY LAW, COURSE OF DEALING, COURSE OF PERFORMANCE, USAGE OF TRADE OR OTHERWISE.

LEGAL DISCLAIMER

Please read carefully.

Franke Kitchen Systems, LLC provides the above information to you for as a public service to our customers. By accessing and using this information, you agree to the following and to comply with all applicable laws. If you do not agree with these terms and conditions, do not use this information. While we try to keep the information current, changes may have occurred since its creation. Contact your Regional Manager or Customer Service to verify information regarding Franke Kitchen Systems, LLC programs and their use by you.

Copyright and Other Intellectual Property Rights. This document and our website are protected by copyright pursuant to U.S. copyright laws, international treaties, and other copyright laws. This document and our website contains copyrighted material, trademarks, and other proprietary information of Franke Kitchen Systems, LLC and others (collectively “Proprietary Material”), which may include, but shall not be limited to: text, software, photos, video, graphics, images, music and sound. You may not modify, publish, copy, transmit, participate in the transfer or sale of, create derivative works of, or in any way exploit, in whole or in part, any Proprietary Material without the prior written authorization of Franke Kitchen Systems, LLC or the applicable rights holder.

Changes. We may change these terms and any part (or all) of the information enclosed at any time without notice. Any changes will apply to your future use, so you should contact your Regional Manager or Customer Service periodically. If you use this information after any changes to these terms, then you accept those changes.

Choice of Law. We are a Delaware limited liability company and these Terms and Conditions, and the purchase of products from Franke Kitchen Systems, LLC, shall be governed by the substantive laws of the State of Delaware, including the Uniform Commercial Code as adopted in Delaware, and the United Nations Convention on Contracts for the International Sale of Goods shall not apply. Any cause of action must be commenced within one year after the claim or cause of action arises. If a court of competent jurisdiction holds these terms and conditions or any part of them to be invalid, then that part shall be enforced to the maximum extent possible and the remainder of these terms and conditions will remain in full force and effect.

HOW TO CONTACT US**Contact Info**

Customer Service: 800-626-5771

Customer Service: ks-customerservice.us@franke.com

Marketing Services Email: ks-marketing-services.us@franke.com

Mailing Address: Franke Kitchen Systems, LLC 800 Aviation Parkway Smyrna, TN 37167

| SINKS | Page | Price |
|--------------|--------|---------|
| CCK110-13WH | 132 | \$715 |
| CCK110-15WH | 132 | \$715 |
| CCK110-19WH | 132 | \$775 |
| CLV110-24 | 50 | \$1,695 |
| CLV110-28 | 50 | \$1,805 |
| CLV110-31 | 50 | \$1,915 |
| CLV120-33 | 51 | \$2,025 |
| CUX11010-W | 21, 78 | \$1,860 |
| CUX11015 | 78 | \$675 |
| CUX11018-W | 26 | \$2,635 |
| CUX11019 | 78 | \$715 |
| CUX11021 | 79 | \$790 |
| CUX11021-ADA | 84 | \$790 |
| CUX11023 | 80 | \$820 |
| CUX11024-W | 26 | \$2,850 |
| CUX11025 | 80 | \$850 |
| CUX11025-8 | 80 | \$850 |
| CUX11027 | 81 | \$910 |
| CUX11027-8 | 81 | \$910 |
| CUX11027-ADA | 84 | \$910 |
| CUX11030 | 82 | \$1,015 |
| CUX11030-8 | 82 | \$1,015 |
| CUX11031-W | 26 | \$3,070 |
| CUX120 | 83 | \$1,125 |
| CUX160 | 83 | \$1,125 |
| CUX16021-W | 21 | \$2,520 |
| CUX16024 | 82 | \$910 |
| CUX16032 | 84 | \$1,170 |
| DIG61091-CHA | 175 | \$530 |
| DIG61091-GRA | 175 | \$530 |
| DIG61091-MOC | 175 | \$530 |
| DIG61091-ONY | 175 | \$530 |
| DIG61091-PWT | 175 | \$530 |
| DIG61091-SHG | 175 | \$530 |
| DIG62D91-CHA | 175 | \$600 |
| DIG62D91-GRA | 175 | \$600 |
| DIG62D91-MOC | 175 | \$600 |
| DIG62D91-ONY | 175 | \$600 |
| DIG62D91-PWT | 175 | \$600 |
| DIG62D91-SHG | 175 | \$600 |
| DIG62F91-CHA | 179 | \$580 |
| DIG62F91-GRA | 179 | \$580 |
| DIG62F91-MOC | 179 | \$580 |
| DIG62F91-ONY | 179 | \$580 |
| DIG62F91-PWT | 179 | \$580 |
| DIG62F91-SHG | 179 | \$580 |
| EDCH33229-1 | 170 | \$530 |
| EDDB33229-1 | 170 | \$530 |
| EDOX33229-1 | 170 | \$530 |
| EDOY33229-1 | 170 | \$530 |
| EDPW33229-1 | 170 | \$530 |
| EDSG33229-1 | 170 | \$530 |
| ELG11022CHA | 168 | \$540 |
| ELG11022MOC | 168 | \$540 |
| ELG11022ONY | 168 | \$540 |
| ELG11022OYS | 168 | \$540 |
| ELG11022PWT | 168 | \$540 |
| ELG11022SHG | 168 | \$540 |
| ELG11022STO | 168 | \$540 |
| ELG120CHA | 168 | \$630 |
| ELG120MOC | 168 | \$630 |
| ELG120ONY | 168 | \$630 |

| SINKS | Page | Price |
|----------------|------|---------|
| ELG120OYS | 168 | \$630 |
| ELG120PWT | 168 | \$630 |
| ELG120SHG | 168 | \$630 |
| ELG120STO | 168 | \$630 |
| ELG160CHA | 169 | \$630 |
| ELG160MOC | 169 | \$630 |
| ELG160ONY | 169 | \$630 |
| ELG160OYS | 169 | \$630 |
| ELG160PWT | 169 | \$630 |
| ELG160SHG | 169 | \$630 |
| ELG160STO | 169 | \$630 |
| ECH33229-1 | 171 | \$540 |
| EODB33229-1 | 171 | \$540 |
| EOOX33229-1 | 171 | \$540 |
| EOOY33229-1 | 171 | \$540 |
| EOPW33229-1 | 171 | \$540 |
| EOSG33229-1 | 171 | \$540 |
| ESCH25229-1 | 170 | \$480 |
| ESDB25229-1 | 170 | \$480 |
| ESOX25229-1 | 170 | \$480 |
| ESoy25229-1 | 170 | \$480 |
| ESPW25229-1 | 170 | \$480 |
| ESSG25229-1 | 170 | \$480 |
| FHK710-30WH | 112 | \$1,165 |
| FHK710-33WH | 112 | \$1,490 |
| FHK710-36WH | 112 | \$1,620 |
| GDX11012 | 90 | \$595 |
| GDX11015 | 90 | \$640 |
| GDX11018 | 90 | \$740 |
| GDX11023 | 91 | \$820 |
| GDX11028 | 91 | \$870 |
| GDX11031 | 92 | \$940 |
| GDX12031 | 92 | \$1,075 |
| GDX16028RH | 92 | \$1,045 |
| GDX16031RH | 93 | \$1,095 |
| KBG11013CHA | 163 | \$520 |
| KBG11013MOC | 163 | \$520 |
| KBG11013ONY | 163 | \$520 |
| KBG11013OYS | 163 | \$520 |
| KBG11013SHG | 163 | \$520 |
| KBG11013STO | 163 | \$520 |
| KBG11031CHA | 163 | \$630 |
| KBG11031MOC | 163 | \$630 |
| KBG11031ONY | 163 | \$630 |
| KBG11031OYS | 163 | \$630 |
| KBG11031SHG | 163 | \$630 |
| KBG11031STO | 163 | \$630 |
| MAG11031OW-CHA | 159 | \$645 |
| MAG11031OW-MBK | 159 | \$645 |
| MAG11031OW-ONY | 159 | \$645 |
| MAG11031OW-OYS | 159 | \$645 |
| MAG11031OW-PWT | 159 | \$645 |
| MAG11031OW-SHG | 159 | \$645 |
| MAG61023CHA | 158 | \$625 |
| MAG61023MBK | 158 | \$625 |
| MAG61023ONY | 158 | \$625 |
| MAG61023OYS | 158 | \$625 |
| MAG61023PWT | 158 | \$625 |
| MAG61023SHG | 158 | \$625 |
| MAG61031OW-CHA | 158 | \$625 |
| MAG61031OW-MBK | 158 | \$625 |
| MAG61031OW-ONY | 158 | \$625 |

| SINKS | Page | Price |
|-----------------|------|---------|
| MAG61031OW-OYS | 158 | \$625 |
| MAG61031OW-PWT | 158 | \$625 |
| MAG61031OW-SHG | 158 | \$625 |
| MHK110-20WH | 118 | \$585 |
| MHK110-24WH | 118 | \$775 |
| MHK110-28WH | 118 | \$840 |
| MHK720-31WH | 119 | \$910 |
| MHK720-35WH | 119 | \$1,295 |
| MHX710-30 | 14 | \$2,190 |
| MHX710-33 | 14 | \$2,630 |
| MHX710-36 | 14 | \$3,175 |
| ODX110-2310-316 | 102 | \$910 |
| ODX110-2312-316 | 102 | \$960 |
| OR2X110 | 65 | \$1,090 |
| ORK110WH | 123 | \$1,295 |
| PCX1102109 | 69 | \$740 |
| PKG11014CHA | 142 | \$540 |
| PKG11014MBK | 142 | \$540 |
| PKG11014MOC | 142 | \$540 |
| PKG11014ONY | 142 | \$540 |
| PKG11014OYS | 142 | \$540 |
| PKG11014PWT | 142 | \$540 |
| PKG11014SHG | 142 | \$540 |
| PKG11014STO | 142 | \$540 |
| PKG11020CHA | 142 | \$650 |
| PKG11020MBK | 142 | \$650 |
| PKG11020MOC | 142 | \$650 |
| PKG11020ONY | 142 | \$650 |
| PKG11020OYS | 142 | \$650 |
| PKG11020PWT | 142 | \$650 |
| PKG11020SHG | 142 | \$650 |
| PKG11020STO | 142 | \$650 |
| PKG11031CHA | 143 | \$760 |
| PKG11031MOC | 143 | \$760 |
| PKG11031MBK | 143 | \$760 |
| PKG11031ONY | 143 | \$760 |
| PKG11031OYS | 143 | \$760 |
| PKG11031PWT | 143 | \$760 |
| PKG11031SHG | 143 | \$760 |
| PKG11031STO | 143 | \$760 |
| PKG160CHA | 144 | \$830 |
| PKG160MBK | 144 | \$830 |
| PKG160MOC | 144 | \$830 |
| PKG160ONY | 144 | \$830 |
| PKG160OYS | 144 | \$830 |
| PKG160PWT | 144 | \$830 |
| PKG160SHG | 144 | \$830 |
| PKG160STO | 144 | \$830 |
| PKX11013 | 32 | \$2,055 |
| PKX11016 | 32 | \$2,275 |
| PKX11018 | 33 | \$2,445 |
| PKX11021 | 33 | \$2,605 |
| PKX11025 | 34 | \$2,665 |
| PKX11028 | 34 | \$2,775 |
| PKX1108 | 32 | \$1,285 |
| PKX160 | 34 | \$3,150 |
| PKX160LH | 34 | \$3,150 |
| PRK11021WH | 127 | \$910 |
| PRX11021 | 69 | \$850 |
| PS2X110-15 | 40 | \$1,535 |
| PS2X110-18 | 40 | \$1,585 |
| PS2X110-21 | 40 | \$1,645 |

| SINKS | Page | Price |
|---------------|------|---------|
| PS2X110-24 | 41 | \$1,705 |
| PS2X110-24-12 | 41 | \$1,755 |
| PS2X110-27 | 42 | \$1,815 |
| PS2X110-30 | 42 | \$1,925 |
| PS2X110-30-12 | 42 | \$2,035 |
| PS2X110-33 | 43 | \$2,190 |
| PS2X120-14-14 | 44 | \$2,300 |
| PS2X120-16-16 | 44 | \$2,410 |
| PS2X160-18-11 | 43 | \$2,300 |
| PTX110-14 | 56 | \$650 |
| PTX110-17 | 56 | \$740 |
| PTX110-20 | 56 | \$960 |
| PTX110-22 | 57 | \$1,070 |
| PTX110-25 | 57 | \$1,125 |
| PTX110-28 | 58 | \$1,200 |
| PTX110-31 | 58 | \$1,315 |
| PTX160-31 | 58 | \$1,500 |
| PTX160-37 | 59 | \$1,550 |
| PTX160-40 | 59 | \$1,650 |
| RBX-110 | 97 | \$590 |
| RGX160 | 73 | \$1,060 |
| SC3322-1 | 179 | \$530 |
| SGR3322-1 | 179 | \$530 |
| SOX1720-1 | 183 | \$400 |
| SP3322-1 | 179 | \$530 |
| SZCH1720-1 | 183 | \$400 |
| SZGR1720-1 | 183 | \$400 |
| SZPW1720-1 | 183 | \$400 |
| UBG110-20CHA | 150 | \$540 |
| UBG110-20MBK | 150 | \$540 |
| UBG110-20MOC | 150 | \$540 |
| UBG110-20ONY | 150 | \$540 |
| UBG110-20PWT | 150 | \$540 |
| UBG110-20SHG | 150 | \$540 |
| UBG110-20STO | 150 | \$540 |
| UBG110-28CHA | 150 | \$605 |
| UBG110-28MBK | 150 | \$605 |
| UBG110-28MOC | 150 | \$605 |
| UBG110-28ONY | 150 | \$605 |
| UBG110-28PWT | 150 | \$605 |
| UBG110-28SHG | 150 | \$605 |
| UBG110-28STO | 150 | \$605 |
| UBG120-28CHA | 151 | \$630 |
| UBG120-28MBK | 151 | \$630 |
| UBG120-28MOC | 151 | \$630 |
| UBG120-28ONY | 151 | \$630 |
| UBG120-28PWT | 151 | \$630 |
| UBG120-28SHG | 151 | \$630 |
| UBG120-28STO | 151 | \$630 |
| UBG120-32CHA | 152 | \$645 |
| UBG120-32MBK | 152 | \$645 |
| UBG120-32MOC | 152 | \$645 |
| UBG120-32ONY | 152 | \$645 |
| UBG120-32PWT | 152 | \$645 |
| UBG120-32SHG | 152 | \$645 |
| UBG120-32STO | 152 | \$645 |

| FAUCETS | Page | Price |
|------------|----------|---------|
| FF3350 | 238 | \$615 |
| FF3352 | 103, 238 | \$750 |
| FF3425BSS | 226 | \$850 |
| FF3450 | 226 | \$695 |
| FF3452SS | 103, 226 | \$850 |
| FF3800 | 233 | \$610 |
| FF3801 | 233 | \$720 |
| FF3802 | 233 | \$720 |
| FF3803 | 233 | \$720 |
| FF3804 | 233 | \$720 |
| FF3805 | 233 | \$720 |
| FF3807 | 233 | \$720 |
| FF3880 | 233 | \$720 |
| FF3900 | 233 | \$610 |
| FF3920 | 233 | \$720 |
| FF3922 | 233 | \$720 |
| FF3940 | 233 | \$720 |
| FF3961 | 233 | \$720 |
| FF3965 | 233 | \$720 |
| FF3980 | 233 | \$720 |
| FF3990 | 233 | \$720 |
| FF4250 | 235 | \$600 |
| FF4400 | 212 | \$645 |
| FF4420 | 212 | \$775 |
| FF4480 | 212 | \$775 |
| FF4700 | 213 | \$615 |
| FF4720 | 213 | \$725 |
| FF4780 | 213 | \$725 |
| FF4800 | 212 | \$645 |
| FF4880 | 212 | \$775 |
| FF5200 | 204 | \$675 |
| FF5220 | 204 | \$825 |
| FF5280 | 204 | \$825 |
| FF5290SB | 204 | \$825 |
| FF5300 | 199 | \$775 |
| FF5380 | 199 | \$930 |
| FF6000A | 192 | \$1,755 |
| FF6080A | 192 | \$1,960 |
| FF7000A | 192 | \$1,755 |
| FF7080A | 192 | \$1,960 |
| FFB3100 | 220 | \$410 |
| FFB3120MBK | 220 | \$520 |
| FFB3180 | 220 | \$520 |
| FFB3325BSS | 239 | \$580 |
| FFB3350 | 239 | \$475 |
| FFB3425BSS | 226 | \$605 |
| FFB3450 | 226 | \$495 |
| FFB4250 | 235 | \$435 |
| FFB5200 | 205 | \$485 |
| FFB5220 | 205 | \$595 |
| FFB5280 | 205 | \$595 |
| FFB5290SB | 205 | \$565 |
| FFP3100 | 220 | \$580 |
| FFP3120MBK | 220 | \$690 |
| FFP3180 | 220 | \$690 |
| FFP3325BSS | 238 | \$715 |
| FFP3350 | 238 | \$585 |
| FFP3425BSS | 226 | \$775 |
| FFP3450 | 226 | \$635 |
| FFP4250 | 235 | \$540 |
| FFP4400 | 213 | \$450 |
| FFP4480 | 213 | \$560 |

| FAUCETS | Page | Price |
|-------------|----------|---------|
| FFP5200 | 205 | \$640 |
| FFP5220 | 205 | \$780 |
| FFP5280 | 205 | \$780 |
| FFP5290SB | 205 | \$780 |
| FFPD3350 | 238 | \$585 |
| FFPD400 | 193 | \$870 |
| FFPD4300 | 212 | \$795 |
| FFPD4350 | 212 | \$935 |
| FFPD4400 | 212 | \$660 |
| FFPD4450 | 212 | \$805 |
| FFPD4600 | 201 | \$1,235 |
| FFPD4611 | 201 | \$1,345 |
| FFPD4621 | 201 | \$1,345 |
| FFPD4680 | 201 | \$1,455 |
| FFPD480 | 193 | \$1,015 |
| FFPD5300 | 199 | \$1,160 |
| FFPD5380 | 199 | \$1,400 |
| FFPD5400 | 199 | \$1,285 |
| FFPD5480 | 199 | \$1,525 |
| FFPD5550 | 217 | \$760 |
| FFPS3425BSS | 227 | \$775 |
| FFPS3450 | 227 | \$635 |
| FFPS4400 | 212 | \$645 |
| FFPS3600 | 221 | \$465 |
| FFPS3680 | 221 | \$580 |
| FFPS4300 | 220 | \$455 |
| FFPS4320 | 220 | \$540 |
| FFPS4380 | 220 | \$540 |
| FFPS4395 | 220 | \$540 |
| FFPS5200 | 204 | \$675 |
| FFPS5220 | 204 | \$825 |
| FFPS5280 | 204 | \$825 |
| FFPS5290SB | 204 | \$825 |
| FFS100 | 192 | \$1,015 |
| FFS180 | 192 | \$1,130 |
| FFS400 | 192 | \$1,015 |
| FFS480 | 192 | \$1,130 |
| FFS5200 | 204 | \$795 |
| FFS5220 | 204 | \$950 |
| FFS5280 | 204 | \$950 |
| FFS5290SB | 204 | \$950 |
| FFT3100 | 221, 242 | \$580 |
| FFT3180 | 221, 242 | \$690 |
| FFT3350 | 239, 242 | \$585 |
| FFT5200 | 205, 242 | \$640 |
| FFT5220 | 205, 242 | \$780 |
| FFT5280 | 205, 242 | \$7 |

| FILTRATION | Page | Price |
|---------------|----------|---------|
| CT-200 | 249 | \$1,035 |
| DW10000 | 222, 247 | \$460 |
| DW10020 | 222, 247 | \$540 |
| DW10080 | 222, 247 | \$540 |
| DW12000 | 194, 243 | \$460 |
| DW12080 | 194, 243 | \$540 |
| DW13025BSS | 227, 248 | \$580 |
| DW13050 | 227, 248 | \$480 |
| DW15000 | 205, 245 | \$475 |
| DW15020 | 205, 245 | \$555 |
| DW15080 | 205, 245 | \$555 |
| DW15090 | 205, 245 | \$555 |
| DW16000 | 214, 245 | \$460 |
| DW16020 | 214, 245 | \$540 |
| DW16022 | 214, 245 | \$540 |
| DW16040 | 214, 245 | \$540 |
| DW16061 | 214, 245 | \$540 |
| DW16065 | 214, 245 | \$540 |
| DW16080 | 214, 245 | \$540 |
| DW16090 | 214, 245 | \$540 |
| DW6100C | 193, 242 | \$435 |
| DW6180C | 193, 242 | \$525 |
| DW7000C | 221, 246 | \$435 |
| DW7020C | 221, 246 | \$525 |
| DW7080C | 221, 246 | \$525 |
| DW9000C | 244 | \$425 |
| DW9080C | 244 | \$515 |
| FFT3100 | 221, 242 | \$580 |
| FFT3180 | 221, 242 | \$690 |
| FFT3350 | 239, 242 | \$585 |
| FFT5200 | 205, 242 | \$640 |
| FFT5220 | 205, 242 | \$780 |
| FFT5280 | 205, 242 | \$780 |
| FRC06 | 252 | \$85 |
| FRC06-2PK | 252 | \$155 |
| FRC07 | 252 | \$85 |
| FRC08 | 252 | \$85 |
| FRC09 | 252 | \$50 |
| FRC10 | 253 | \$100 |
| FRCNSTR | 249 | \$335 |
| FRCNSTR-DUO-1 | 250 | \$370 |
| FRCNSTR-DUO-2 | 250 | \$370 |
| FRCNSTR100 | 249 | \$220 |
| FRX02 | 251 | \$85 |
| HT-400 | 249 | \$460 |
| LB10100 | 222, 247 | \$460 |
| LB10120 | 222, 247 | \$540 |
| LB10180 | 222, 247 | \$540 |
| LB10200 | 223, 248 | \$580 |
| LB10220 | 223, 248 | \$700 |
| LB10280 | 223, 248 | \$700 |
| LB12100 | 194, 243 | \$460 |
| LB12180 | 194, 243 | \$540 |
| LB12200 | 195, 244 | \$580 |
| LB12280 | 195, 244 | \$700 |
| LB13125BSS | 227, 248 | \$580 |
| LB13150 | 227, 248 | \$480 |
| LB13225BSS | 228, 248 | \$695 |
| LB13250 | 228, 248 | \$590 |
| LB15100 | 206, 245 | \$475 |

| FILTRATION | Page | Price |
|------------|----------|-------|
| LB15120 | 206, 245 | \$555 |
| LB15180 | 206, 245 | \$555 |
| LB15190 | 206, 245 | \$555 |
| LB15200 | 206, 245 | \$580 |
| LB15220 | 206, 245 | \$700 |
| LB15280 | 206, 245 | \$700 |
| LB15290 | 206, 245 | \$700 |
| LB16100 | 214, 246 | \$460 |
| LB16120 | 214, 246 | \$540 |
| LB16122 | 214, 246 | \$540 |
| LB16140 | 214, 246 | \$540 |
| LB16161 | 214, 246 | \$540 |
| LB16165 | 214, 246 | \$540 |
| LB16180 | 214, 246 | \$540 |
| LB16190 | 214, 246 | \$540 |
| LB16200 | 214, 246 | \$580 |
| LB16220 | 214, 246 | \$700 |
| LB16222 | 214, 246 | \$700 |
| LB16240 | 214, 246 | \$700 |
| LB16261 | 214, 246 | \$700 |
| LB16265 | 214, 246 | \$700 |
| LB16280 | 214, 246 | \$700 |
| LB16290 | 214, 246 | \$700 |
| LB6100C | 194, 243 | \$435 |
| LB6180C | 194, 243 | \$525 |
| LB6200C | 194, 243 | \$600 |
| LB6280C | 194, 243 | \$720 |
| LB7100C | 222, 247 | \$435 |
| LB7120C | 222, 247 | \$525 |
| LB7180C | 222, 247 | \$525 |
| LB7200C | 222, 247 | \$600 |
| LB7220C | 222, 247 | \$720 |
| LB7280C | 222, 247 | \$720 |
| LB9100C | 244 | \$425 |
| LB9180C | 244 | \$515 |
| LB9200C | 244 | \$590 |
| LB9280C | 244 | \$700 |
| SB60 | 253 | \$45 |

SOAP DISPENSERS

| | | |
|-----------|----------|-------|
| 902-C | 257 | \$150 |
| 902-SN | 257 | \$185 |
| SD-500 | 256 | \$300 |
| SD-580N | 256 | \$360 |
| SD-800 | 256 | \$400 |
| SD-880N | 256 | \$480 |
| SD2600 | 201, 256 | \$205 |
| SD2680 | 201, 256 | \$240 |
| SD3100 | 223, 258 | \$130 |
| SD3120MBK | 223, 258 | \$165 |
| SD3180 | 223, 258 | \$165 |
| SD3200 | 233, 258 | \$125 |
| SD3201 | 233, 258 | \$160 |
| SD3202 | 233, 258 | \$160 |
| SD3203 | 233, 258 | \$160 |
| SD3204 | 233, 258 | \$160 |
| SD3205 | 233, 258 | \$160 |
| SD3207 | 233, 258 | \$160 |
| SD3220 | 233, 258 | \$160 |
| SD3222 | 233, 258 | \$160 |

| SOAP DISPENSERS | Page | Price |
|-----------------|----------|-------|
| SD3240 | 233, 258 | \$160 |
| SD3261 | 233, 258 | \$160 |
| SD3265 | 233, 258 | \$160 |
| SD3280 | 233, 258 | \$160 |
| SD3290 | 233, 258 | \$160 |
| SD3425BSS | 228, 257 | \$250 |
| SD3450SS | 228, 256 | \$250 |
| SD5200 | 206, 257 | \$150 |
| SD5220 | 206, 257 | \$185 |
| SD5280 | 206, 257 | \$185 |
| SD5290SB | 206, 257 | \$185 |
| SD6000 | 195, 257 | \$200 |
| SD6080 | 195, 257 | \$230 |

DISPOSERS

| | | |
|----------------|-----|-------|
| FWDJ125 | 263 | \$520 |
| FWDJ50 | 263 | \$255 |
| FWDJ75 | 263 | \$410 |
| FWDJ75B | 263 | \$500 |
| WD3428BK | 265 | \$35 |
| WD3428C | 265 | \$35 |
| WD3428SN | 265 | \$35 |
| WD907BLK | 265 | \$75 |
| WD9088 | 265 | \$130 |
| WD930CH | 265 | \$75 |
| WD981SN | 265 | \$75 |
| WD982PN | 265 | \$75 |
| WDFLANGE-BK | 266 | \$69 |
| WDFLANGE-CH | 266 | \$65 |
| WDFLANGE-EX-SN | 266 | \$67 |
| WDFLANGE-EX-WH | 266 | \$65 |
| WDFLANGE-SS | 266 | \$65 |
| WDJ33 | 265 | \$180 |
| WDJ50 | 264 | \$215 |
| WDJ50NC | 264 | \$195 |
| WDJ75 | 264 | \$305 |
| WDJ75NC | 264 | \$280 |

ACCESSORIES

| | | |
|-----------|--|-------|
| 628 | 273 | \$9 |
| 903 | 15, 27, 33, 35, 51, 65, 69, 73, 79, 81, 83, 85, 91, 93, 97, 273 | \$35 |
| 906 | 15, 21, 27, 41, 43, 44, 57, 59, 65, 69, 73, 79, 81, 83, 85, 91, 93, 97, 102, 113, 119, 144, 151, 152, 159, 163, 169, 270 | \$70 |
| 900P | 69, 73, 91, 93, 97, 272 | \$125 |
| 900P-SN27 | 69, 73, 91, 93, 97, 272 | \$150 |
| 900W | 270 | \$60 |
| 906D-SN | 270 | \$160 |
| 906P-C | 27, 57, 59, 79, 81, 83, 85, 272 | \$135 |
| 906P-SN | 27, 57, 59, 79, 81, 83, 85, 272 | \$160 |

| ACCESSORIES | Page | Price |
|-------------|--|-------|
| 906SN | 15, 21, 27, 41, 43, 44, 57, 59, 65, 69, 73, 79, 81, 83, 85, 91, 93, 97, 102, 113, 119, 123, 127, 133, 143, 144, 151, 152, 159, 163, 169, 270 | \$95 |
| AG100 | 271 | \$55 |
| AG120 | 271 | \$65 |
| AG122 | 271 | \$65 |
| AG140 | 271 | \$65 |
| AG150 | 271 | \$65 |
| AG161 | 271 | \$65 |
| AG165 | 271 | \$65 |
| AG180 | 271 | \$65 |
| AG190 | 271 | \$65 |
| BG400S | 151 | \$110 |
| BG410S | 151 | \$160 |
| BG430S | 151, 152 | \$105 |
| BG440S | 151 | \$100 |
| BG450S | 152 | \$115 |
| BGDI100 | 175 | \$125 |
| BGDI110 | 175 | \$135 |
| BGDIL150 | 179 | \$125 |
| BGDIS150 | 179 | \$125 |
| CK13-36C | 133 | \$220 |
| CK15-36C | 133 | \$230 |
| CK19-36C | 133 | \$245 |
| CL-14-36S | 51 | \$165 |
| CL-24-36S | 51 | \$165 |
| CL-28-36S | 51 | \$175 |
| CL-31-36S | 51 | \$190 |
| CL-BGC | 51 | \$150 |
| CL-SSC | 51 | \$125 |
| CL-WGC | 51 | \$150 |
| CP-50C | 73 | \$280 |
| CU10-36S | 83 | \$115 |
| CU11-36S | 83 | \$125 |
| CU13-36S | 83, 85 | \$120 |
| CU15-36S | 79, 83 | \$135 |
| CU17-36S | 85 | \$135 |
| CU18-36S | 83 | \$150 |
| CU19-36S | 79 | \$140 |
| CU21-36S | 21, 79, 85 | \$150 |
| CU23-36S | 81 | \$150 |
| CU25-36S | 81 | \$165 |
| CU25-8-36S | 81 | \$160 |
| CU27-36S | 81, 85 | \$165 |
| CU27-8-36S | 81 | \$160 |
| CU30-36S | 83 | \$175 |
| CU30-8-36S | 83 | \$170 |
| CU-40K | 21, 79 | \$255 |
| CU-40P | 21, 79, 81, 83, 85 | \$150 |
| CU-40S | 21, 79, 81, 83, 85 | \$160 |
| CU-FC | 21, 79 | \$215 |
| CU-GC | 21, 79 | \$125 |
| CU-KS | 21, 79 | \$105 |
| CU-WR | 21, 79 | \$135 |
| CUW-36RM | 27 | \$150 |
| CUW-40S | 27 | \$175 |
| CUW-60S | 27 | \$200 |
| CUW-70S | 21, 27, 79, 81, 83, 85 | \$210 |

| ACCESSORIES | Page | Price |
|-------------|-----------------------------|-------|
| CUW18-36S | 27 | \$150 |
| CUW24-36S | 27 | \$165 |
| CUW31-36S | 27 | \$175 |
| ELG13-36S | 169 | \$135 |
| ELG14-36S | 169 | \$150 |
| ELG16-36S | 169 | \$165 |
| ELG22-36S | 169 | \$165 |
| FBBG2716 | 179 | \$150 |
| FBG180S | 183 | \$95 |
| FBGG1014 | 171 | \$105 |
| FBGG1114 | 171 | \$105 |
| FBGG1316 | 171 | \$115 |
| FBGG1914 | 171 | \$125 |
| FK30-36S | 113 | \$270 |
| FK33-36S | 113 | \$300 |
| FK36-36S | 113 | \$315 |
| FRTWIST-SN | 15, 33, 35, 272 | \$170 |
| GD12-36S | 91, 93 | \$135 |
| GD15-36S | 91, 93 | \$150 |
| GD18-36S | 91 | \$165 |
| GD23-36S | 91 | \$175 |
| GD28-36S | 91 | \$210 |
| GD28-40S | 91 | \$270 |
| GD31-36S | 93 | \$220 |
| GD-40S | 91, 93 | \$270 |
| KBG13-36S | 163 | \$135 |
| KBG31-36S | 163 | \$220 |
| MA-17-31LRM | 159 | \$160 |
| MA-31-36S | 159 | \$260 |
| MA-31RM | 159 | \$160 |
| MA-40S | 159 | \$185 |
| MA-70S | 159 | \$210 |
| MH30-36S | 15 | \$230 |
| MH33-36S | 15 | \$255 |
| MH36-36S | 15 | \$280 |
| MK24-36C | 119 | \$230 |
| MK28-36C | 119 | \$255 |
| MK31-36C-LH | 119 | \$245 |
| MK31-36C-RH | 119 | \$245 |
| MK35-36C-LH | 119 | \$290 |
| MK35-36C-RH | 119 | \$290 |
| NC12-36S | 93 | \$80 |
| NC18-36S | 93 | \$115 |
| OA-40S | 15, 113, 119, 123, 127, 133 | \$385 |
| OC2-31S-RH | 65 | \$170 |
| OC2-36S | 65 | \$235 |
| OC2-45SP | 65 | \$355 |
| OC2-50C | 65 | \$170 |
| OC2-60S | 65 | \$135 |
| OK-31C-LH | 123 | \$175 |
| OK-31C-RH | 123 | \$175 |
| OK-36C | 123 | \$245 |
| PE-70S | 41, 43, 44, 51, 57, 59 | \$230 |
| PG-40S | 143, 144 | \$225 |
| PG2-40S | 143 | \$215 |
| PK21-31S | 127 | \$165 |
| PK21-36S | 127 | \$165 |
| PKG12-36RM | 144 | \$140 |
| PKG12-36S | 144 | \$150 |

| ACCESSORIES | Page | Price |
|-------------|---------------------------|-------|
| PKG14-31RM | 143 | \$135 |
| PKG14-36RM | 143 | \$170 |
| PKG17-36RM | 144 | \$175 |
| PKG17-36S | 144 | \$175 |
| PKG18-31RM | 143, 144 | \$165 |
| PKG20-36RM | 143 | \$195 |
| PKG31-36RM | 143 | \$220 |
| PKG31-36S | 143 | \$230 |
| PKGCVR | 27, 57, 59, 143, 144, 271 | \$90 |
| PKXCVR | 33, 35, 271 | \$105 |
| PR-31S | 69 | \$165 |
| PR-36S | 69 | \$165 |
| PS2-11-36S | 43 | \$130 |
| PS2-14-36S | 44 | \$140 |
| PS2-15-36S | 41 | \$150 |
| PS2-16-36S | 44 | \$150 |
| PS2-18-36S | 41, 43 | \$165 |
| PS2-21-36S | 41 | \$200 |
| PS2-24-36S | 41 | \$210 |
| PS2-27-36S | 43 | \$230 |
| PS2-30-36S | 43 | \$270 |
| PS2-33-36S | 43 | \$290 |
| PS2-45S | 41, 43, 44, 51 | \$230 |
| PS23-36S | 102 | \$245 |
| PT14-31S | 57, 59 | \$150 |
| PT14-36S | 57, 59 | \$150 |
| PT17-36S | 57, 59 | \$150 |
| PT20-36S | 57 | \$165 |
| PT22-36S | 57, 59 | \$165 |
| PT25-36S | 57 | \$165 |
| PT28-36S | 59 | \$175 |
| PT31-36S | 59 | \$190 |
| PT-40S | 57, 59 | \$220 |
| PT-41S | 57, 59 | \$210 |
| PX-13S | 33 | \$150 |
| PX-16S | 33 | \$150 |
| PX-18S | 33 | \$165 |
| PX-21S | 33, 35 | \$200 |
| PX-25S | 35 | \$210 |
| PX-28S | 35 | \$220 |
| PX-40S | 33, 35 | \$230 |
| PX-70S | 33, 35, 151, 152 | \$220 |
| RG-36S | 73 | \$165 |
| RG-36S-RH | 73 | \$165 |
| RM18S | 41, 43, 44, 51 | \$165 |
| RNDVCVR | 21, 41, 43, 44, 65, 271 | \$90 |
| SP-40S | 21, 27, 57, 59, 79 | \$60 |
| UG-40S | 151, 152 | \$135 |
| UV-36RM | 33, 3 | |

Table with 16 columns: PRODUCT NO., Page, Price, PRODUCT NO., Page, Price, PRODUCT NO., Page, Price, PRODUCT NO., Page, Price, PRODUCT NO., Page, Price, PRODUCT NO., Page, Price. It lists various product models and their associated page and price information.

Quick Reference

Quick Reference



2021 KWC
Kitchen Collection

www.kwc.com/us

KWC



SWISS WATER EXPERIENCE

FAUCETS FOR THE KITCHEN

| | |
|--------------------------------|----|
| KWC ERA | 12 |
| KWC ZOE touch light PRO | 20 |
| KWC ZOE | 24 |
| KWC ONO touch light PRO | 28 |
| KWC ONO | 32 |
| KWC SIN | 38 |
| KWC EVE | 44 |
| KWC SUPRIMO | 48 |
| KWC LIVELLO | 54 |
| KWC AVA | 56 |
| KWC DOMO | 62 |
| KWC LUNA-E | 68 |
| KWC Potfillers | 74 |
| ACCESSORIES | |
| KWC Soap dispensers | 76 |
| KWC Escutcheons | 79 |

THE PURSUIT OF PERFECTION

Our technology is designed not to be noticed, but to be useful. This is reflected in our kitchen faucets. Every detail is just right, every movement is perfect, every function impresses.

BRILLIANT SOLUTIONS

At KWC, we want to achieve excellence in everything we create. Our destiny is not to invent products, it is to perfect them.

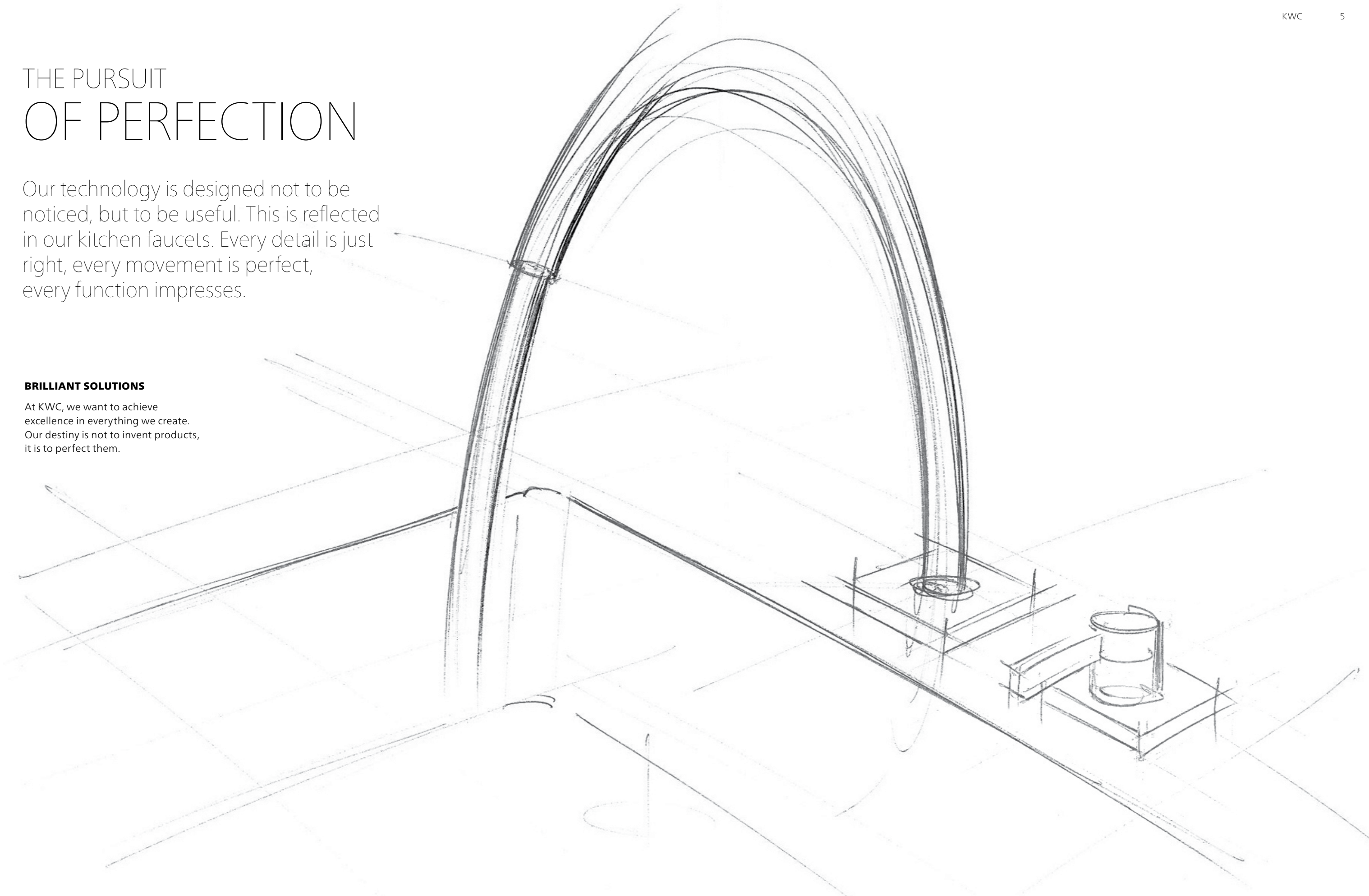

REPRESENTING PERFECTION SINCE 1874



MANUFACTURING EXCELLENCE

KWC has been famous for compelling design, aesthetics and precision for more than 140 years. Originally the company channeled its expertise into the manufacturing of exquisite music boxes, but by the end of the 19th century, those skills were being redirected into the development and production of excellent faucets.



CRAFTED BY KNOWLEDGE & PRECISION

THE SWISS DNA

KWC's Swiss heritage is very important for the manufacturing of faucets. The Swiss have a great love of detail, reliability and functional design. KWC pursues perfection every day and connects people to the natural resource of water. This is what we call the Swiss water experience.

This is what we live.

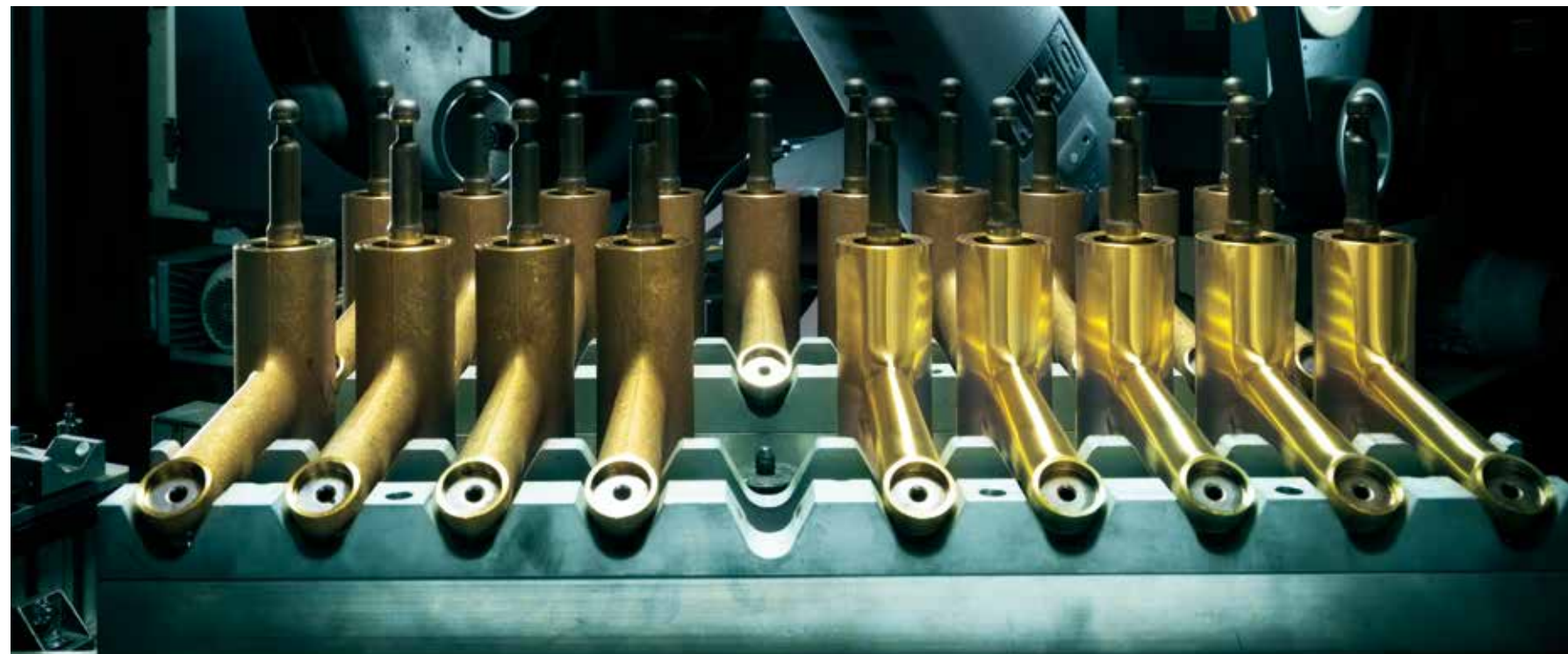

TECHNOLOGY & INNOVATION

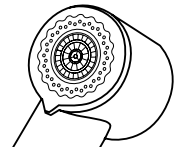

JETCLEAN

The jetclean faceplate prevents limescale deposits in the kitchen spray and makes it easier to clean. The cone-shaped sieve holes expand when water flows to blast off stubborn limescale deposits. The holes return to their normal size once the water is turned off.

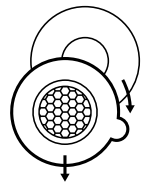

FAST AND CLEAN

If limescale residue becomes stuck in the faceplate of your faucet, the turn and clean fastening mechanism (TAC) provides assistance: turn, clean and you're done.



FAST AND FIXED

The turn and lock fastening mechanism (TAL) keeps things simple. This technology keeps the stream of your kitchen spray in the right position.

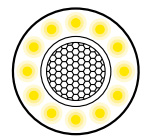

LUMINAQUA

Setting the right mood, luminaqua technology ensures the perfect ambiance in your kitchen. This brilliant technology produces a wonderful interplay of light with the water stream from your faucet at the touch of a button. The light ring is exquisitely integrated into the pull-out aerator, making it practically invisible. The LEDs require minimum power and ensure a maximum service life. The light switches off automatically after 30 to 45 minutes.

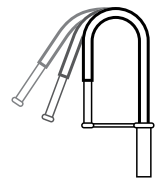

HIGHFLEX

This patented spring hose appreciates good guidance. It can be flexibly moved in every direction, is easy to clean and has a reliably stable spout when not in use.

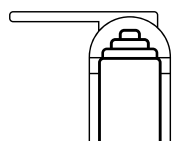

FLEXGUARD

This innovative sealing membrane keeps KWC faucets watertight for a long period of time. It protects the control cartridge from residue left by cleaning agents and dirt. The lever support is reinforced with a metal core and integrated into the membrane, reliably preventing the lever from coming loose.

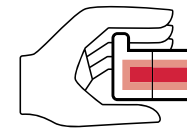

TOUCHCONTROL

The touchcontrol protection solution with dual water guidance system ensures that you never burn your fingers on your faucet. The insulated hot water supply with a "double skin" principle keeps the body of the faucet warm without letting it get too hot.

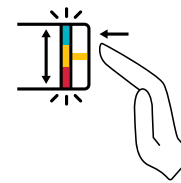

TIPCONTROL

On low-contact faucets with DDSA® sensor technology, you can set the water temperature to suit your personal preference. One tap means cold (blue), two taps means warm (orange) and three means hot (red). Pressing the faucet for five seconds will activate the cleaning function (green).

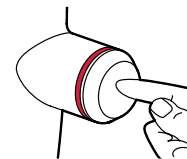

ELECTRONIC CONTROLLED

Our TLP (touch and tip) operation for our electronically controlled faucets is a new and very easy way to change the temperature and flow rate of your KWC TLP faucet. Touch once, twice or three times and you get cold, warm or hot water instantly. Temperature is indicated by a light ring from blue to red.



CONTROL CARTRIDGES

You can rely on KWC control cartridges – after all, they have proven themselves a million times over. At the heart of a KWC faucet, they control the water mixture thanks to two perforated ceramic discs with grease wells. Our faucets are equipped with various additional functions depending on where you use them.



ECOPROTECT

For the highest energy classes and responsible use of resources, EcoProtect represents our commitment to promoting a sustainable lifestyle. For example, the turning handle limits the water flow level. To switch off the water-saving mode, simply turn the handle back past the soft catch point.

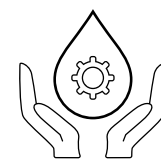

HEALTHPROTECT

Better hygiene and unchanged water quality: HealthProtect highlights the strict standards we set ourselves to ensure that our faucets do not affect the taste and smell of your water – that is why we use high-quality materials (metals, plastics) that are ideally suited for contact with water.

KWC **ERA**

AWARD-WINNING DESIGN

Elegant, slim and designed with absolute precision, KWC ERA brings a new level of sophistication to the kitchen. A timeless design with enduring beauty, KWC ERA is crafted from stainless steel, a pure material with a flawless finish. Featuring a swivel range that can be adjusted from 150° to 360°, KWC ERA is available with four different spouts – Gravity, J, or L spout, and the J spout with pull-down spray – allowing you to customize this lever mixer faucet to suit your personal style.

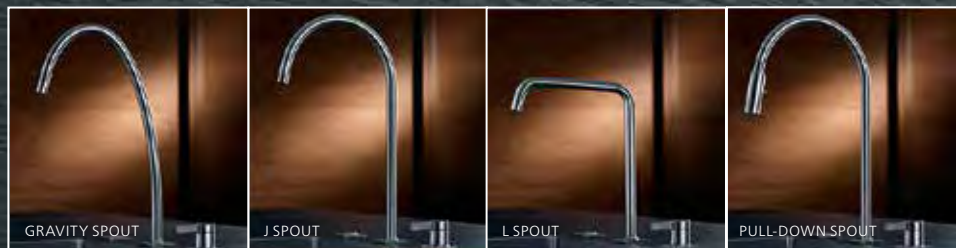

reddot design award

KWC ERA PURE & SIMPLE



LUXURY FINISHES

Precision is the main attribute of the KWC ERA faucets. They feature a plain and smooth surface with a precise and sophisticated finish.



ELEGANCE IN EVERY DETAIL

Slim proportions and graceful spouts create the perfect Swiss water experience.



NEW & EXCEPTIONAL
KWC ERA is for people who demand the absolute best products. With KWC ERA, we introduce faucets with a very minimalistic design, sleek proportions, high functionality and a fascinating high precision look.



ERA Pull-Down Faucet with jetclean

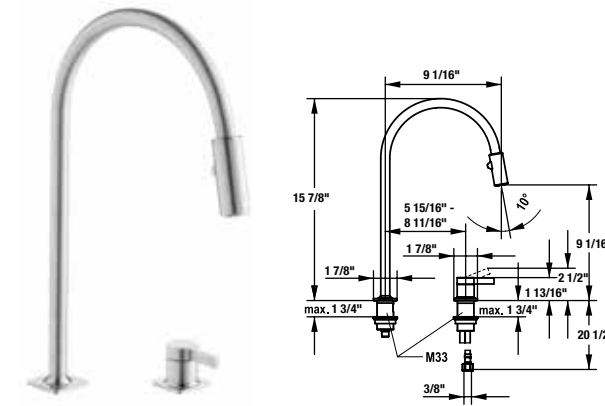

10.392.323.700
solid stainless steel

\$1,750

- Single-lever mixer - optional right or left side lever installation
- 2 hole
- jetclean technology prevents limescale deposits
- Touchcontrol anti-scald protection
- Professional 360° pull-down spray head
- Magnetic hose guide secures hose back into place
- Hose pull out length up to 20"
- KWC safety control 25mm ceramic cartridge
- Variable flow rate and temperature control
- Flow rate max 1.75 gpm (60 psi)
- Overall height 15 7/8"
- Spout swivel range 150° - 360°
- Spout reach from deck 9 1/16"
- Mounting hole size \varnothing 1 3/8"

ERA Gravity Spout Faucet

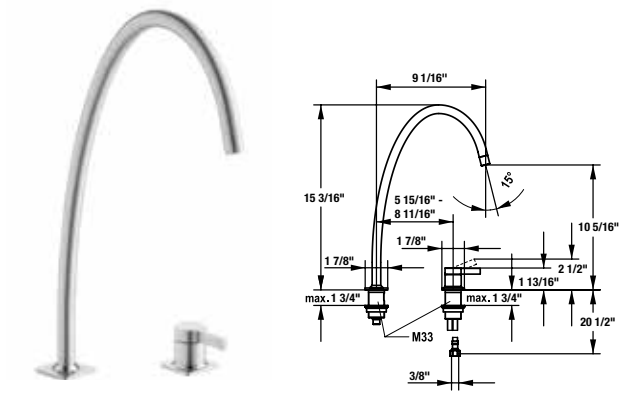

10.392.024.700
solid stainless steel

\$1,640

- Single-lever mixer - optional right or left side lever installation
- 2 hole
- Perlator® hidden aerator
- KWC safety control 25mm ceramic cartridge
- Variable flow rate and temperature control
- Flow rate max 1.75 gpm (60 psi)
- Overall height 15 3/16"
- Spout swivel range 150° - 360°
- Spout reach from deck 9 1/16"
- Mounting hole size \varnothing 1 3/8"

ERA
J-Spout Faucet

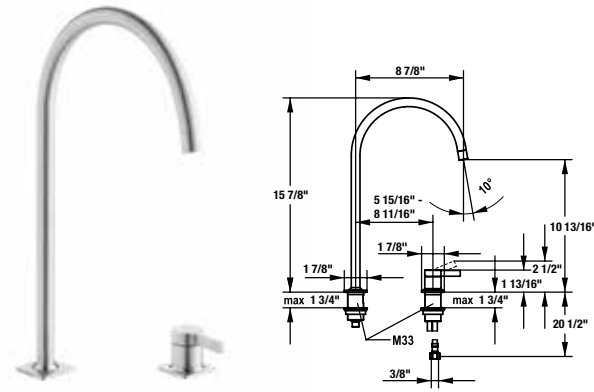

10.392.023.700 **\$1,420**
solid stainless steel

- Single-lever mixer - optional right or left side lever installation
- 2 hole
- Perlator® hidden aerator
- KWC safety control 25mm ceramic cartridge
- Variable flow rate and temperature control
- Flow rate max 1.75 gpm (60 psi)
- Overall height 15 7/8"
- Spout swivel range 150° - 360°
- Spout reach from deck 8 7/8"
- Mounting hole size \varnothing 1 3/8"

ERA
L-Spout Faucet

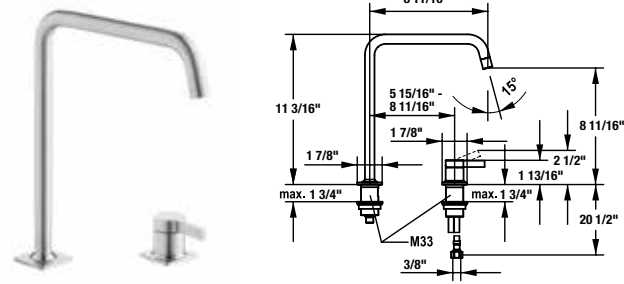

10.392.022.700 **\$1,420**
solid stainless steel

- Single-lever mixer - optional right or left side lever installation
- 2 hole
- Perlator® hidden aerator
- KWC safety control 25mm ceramic cartridge
- Variable flow rate and temperature control
- Flow rate max 1.75 gpm (60 psi)
- Overall height 11 3/16"
- Spout swivel range from 150° - 360°
- Spout reach from deck 8 11/16"
- Mounting hole size \varnothing 1 3/8"

ERA
Soap Dispenser

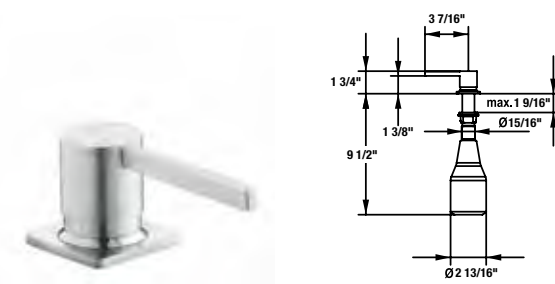

Z.538.038.700 **\$540**
solid stainless steel

- Antimicrobial soap container
- Easy to use, one hand pump operation
- Refillable from surface, no need for removing soap container
- Large capacity bottle 11.8 fl oz. Z.538.053
- Mounting hole size \varnothing 1"



KWC ZOE touch light PRO is a faucet controlled using smart technology. It responds intuitively to a gentle touch and is extremely easy to program to suit your personal habits and needs. The full range of functions is encapsulated in the round operating unit, which features a ring of light that indicates the water temperature at any given time.

KWC **ZOE** touch light PRO ARTISTRY IN MOTION



TOUCH AND REFRESH – 1 x TAP

Cold water = blue. For drinking a quick glass of water, washing fruit or preparing salad.

TOUCH AND CLEAN – 2 x TAP

Warm water = orange. For quickly washing your hands, rinsing off a plate or filling small pans.

TOUCH AND PREPARE – 3 x TAP

Hot water = red. For filling pasta pans and kettles or washing up roasting tins and baking trays.



ZOE touch light PRO Pull-Down Faucet with luminaqua LED-Technology

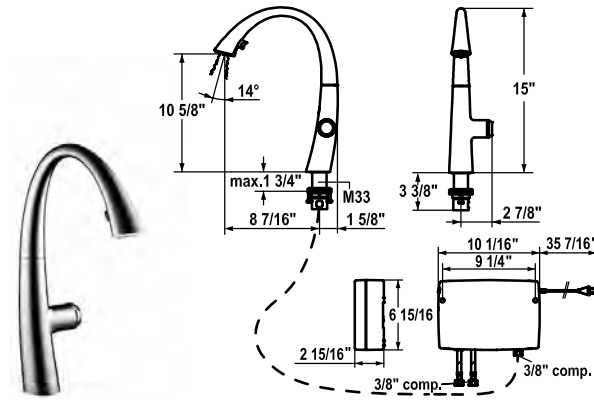

| | |
|----------------------------|----------------|
| 10.201.242.127 | \$3,460 |
| splendure™ stainless steel | |
| 10.201.242.000 | \$2,910 |
| chrome | |
| 10.201.242.176 | \$3,210 |
| matte black | |

- Electronically controlled touch light PRO technology
- Easy touch operation for 3 preset temperatures and flow rate; cold, warm, and hot water
- Flow rates can be individually adjusted and saved
- jetclean technology prevents limescale deposits
- cascade® limescale protection aerator
- Concealed pull-down spray head
- Cold water flow positioned towards front for child safety
- luminaqua LED light with integrated on/off switch
- Light switches off automatically after 30 minutes
- Hose pull out length up to 20"
- Hose guide secures hose back into place
- KWC 25mm ceramic cartridge
- Variable flow rate and temperature control
- Flow rate max 1.75 gpm (60 psi)
- Overall height 15"
- Spout swivel range 270°
- Spout reach from deck 8 7/16"
- Mounting hole size ø1 3/8"
- Power supply 100-240 V, operating voltage 6.75 V, power cord 43" in length
- Order separately: Z.536.352 1500mm extension set



KWC ZOE

ICON WITH STYLE



SAFE AND SOUND

KWC ZOE particularly proves its worth in households where small children are around. Cold water flows when the lever is pointing forward and mixed water runs when it is in the central position, keeping guests of all ages safe from scalding in the kitchen.



ON AND OFF

A touch of a button is all it takes for luminaqua to transform the jet of water from your faucet into a wonderful play of light. The light switches off automatically after 30 minutes.

With KWC ZOE, you can channel our 140 years of expertise in working with water into your kitchen in the form of a sculptural masterpiece. This faucet combines clever functions with a captivating interplay of light and water and the distinctive hallmark of a master in unparalleled perfection. In short, KWC ZOE brings a whole new level of luxury to your kitchen.



ZOE Pull-Down Faucet with luminaqua LED-Technology

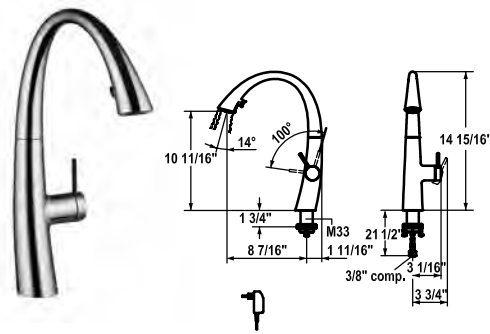

| | |
|----------------------------|----------------|
| 10.201.122.127 | \$1,915 |
| splendure™ stainless steel | |
| 10.201.122.000 | \$1,535 |
| chrome | |
| 10.201.122.176 | \$1,755 |
| matte black | |

- Single-lever mixer - right side lever installation only
- jetclean technology prevents limescale deposits
- cascade® limescale protection aerator
- Concealed pull-down spray head
- Cold water flow positioned towards front for child safety
- luminaqua LED light with integrated on/off switch
- Light switches off automatically after 30 minutes
- Hose pull out length up to 20"
- Hose guide secures hose back into place
- KWC 25mm ceramic cartridge
- Variable flow rate and temperature control
- Flow rate max 1.75 gpm (60 psi)
- Overall height 14 15/16"
- Spout swivel range 270°
- Spout reach from deck 8 7/16"
- Mounting hole size \varnothing 1 3/8"
- Power supply 100-240 V, operating voltage 6.75 V, power cord 43" in length

ZOE Pull-Down Faucet with jetclean

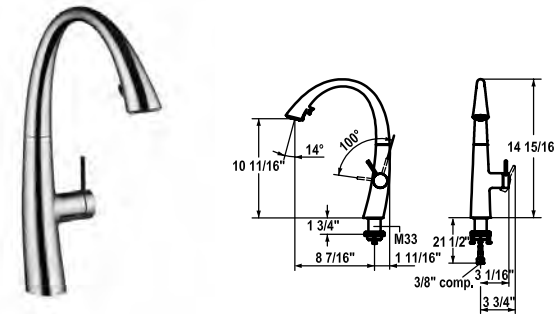

| | |
|----------------------------|----------------|
| 10.201.102.127 | \$1,645 |
| splendure™ stainless steel | |
| 10.201.102.000 | \$1,280 |
| chrome | |
| 10.201.102.176 | \$1,465 |
| matte black | |

- Single-lever mixer - right side lever installation only
- jetclean technology prevents limescale deposits
- cascade® limescale protection aerator
- Concealed pull-down spray head
- Cold water flow positioned towards front for child safety
- Hose pull out length up to 20"
- Hose guide secures hose back into place
- KWC 25mm ceramic cartridge
- Variable flow rate and temperature control
- Flow rate max 1.75 gpm (60 psi)
- Overall height 14 15/16"
- Spout swivel range 270°
- Spout reach from deck 8 7/16"
- Mounting hole size \varnothing 1 3/8"

ZOE Soap Dispenser

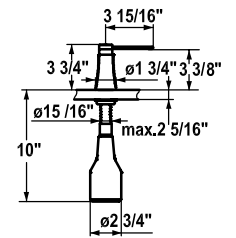

| | |
|----------------------------|--------------|
| Z.536.586.127 | \$605 |
| splendure™ stainless steel | |
| Z.536.586.000 | \$495 |
| chrome | |
| Z.536.586.176 | \$505 |
| matte black | |

- Antimicrobial soap container
- Easy to use, one hand pump operation
- Refillable from surface, no need for removing soap container
- Large capacity bottle 11.8 fl oz. Z.635.713
- Mounting hole size \varnothing 1" - 1 3/8"
- Ordered separately:
Escutcheon Z.536.291.000



KWC ONO touch light PRO makes every important element seem simple, leaving you to focus on the essential issues in the kitchen. This clever faucet takes the benefits offered by KWC ONO and enhances them with a touch of sophistication and an even greater dose of technological intelligence.

KWC **ONO** touch light PRO A TECHNOLOGICAL MASTERPIECE



TIP: JUST TAP

You can call up preset water temperatures and flow rates quickly and conveniently by simply tapping the operating unit: One tap means cold (blue), two taps mean warm (orange) and three means hot (red). Of course, you can also adjust these settings to suit your preferences.

ONO touch light PRO highflex PRO Faucet with LED-Technology

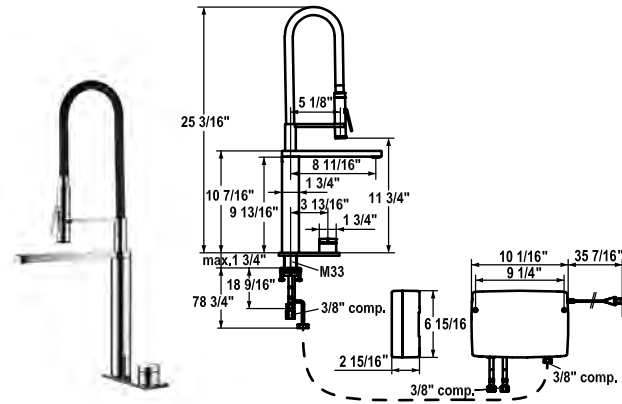

10.651.122.000
chrome

\$5,155

- Electronically controlled touch light PRO technology
- Easy touch operation for 3 preset temperatures and flow rate; cold, warm, and hot water
- highflex spring hose technology allows flexibility in any direction
- caché® adjustable, hidden aerator reduces splash and side spray
- Professional 360° turn spray head
- Maintenance free touch light PRO control unit
- Variable flow rate and temperature control
- Flow rate max 1.75 gpm (60 psi)
- Overall height 25 3/16"
- Spout swivel range 360°
- Spout reach from deck 8 11/16"
- Mounting hole size \varnothing 1 3/8"
- Power supply 100-240 V, operating voltage 15 V, power cord 35" in length

ONO touch light PRO Wireless Control

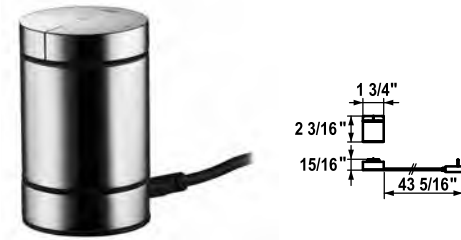

Z.536.638.000
chrome

\$1,917

- KWC ONO touch light PRO wireless operating unit with charging station
- Rechargeable battery life 3-4 months
- Power supply 100-240 V / operating voltage 6.75 V / cable length 31"

ONO touch light PRO Extension Hose

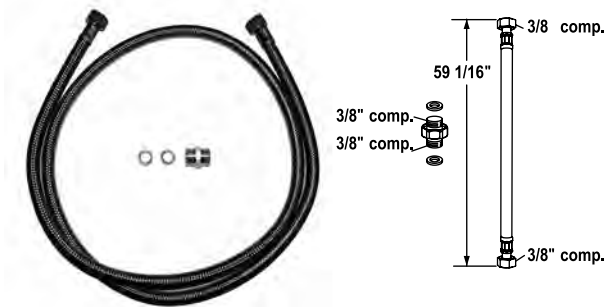

Z.536.352

\$102

- Stainless steel hose 1500 mm, 3/8"x 3/8", double nipple, sealing material
- 3/8" thread type

ONO touch light PRO Rough-In



Z.636.183

\$20

- Rough-in for touch light PRO operating unit
- Plastic suitable for installation on brickwork or cavity walls

KWC **ONO**

SIMPLY SMART



HIGH TECH AND HIGHLY FLEXIBLE

The innovative highflex spring hose opens your kitchen door to the future. This hose, designed as a sweeping curve, can be moved in any direction, returns to its original position automatically and stays firmly in place when it is not being used – even without the spray holder.

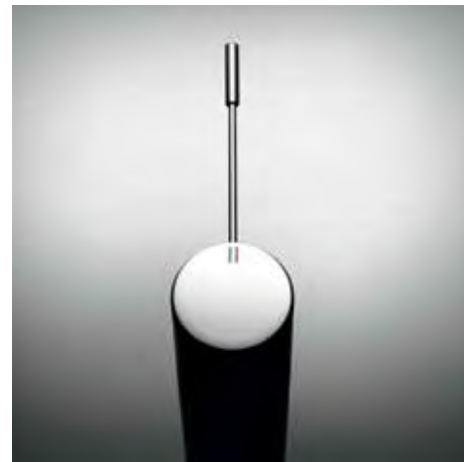

DIRECT AND PRECISE

The KWC ONO operating lever is made of the kind of unbreakable, corrosion-resistant stainless steel you would normally find in medical technology. This means that you can count on perfect precision when you use it.



KWC ONO appeals to your appreciation for all things practical – and to your sophistication. That is why this simple faucet for the kitchen is not only designed to be extra robust, but it also has an exceptionally fine finish. KWC ONO ably assists you with its intelligent functions, yet it is always the perfect picture of elegance.



ONO highflex PRO Faucet

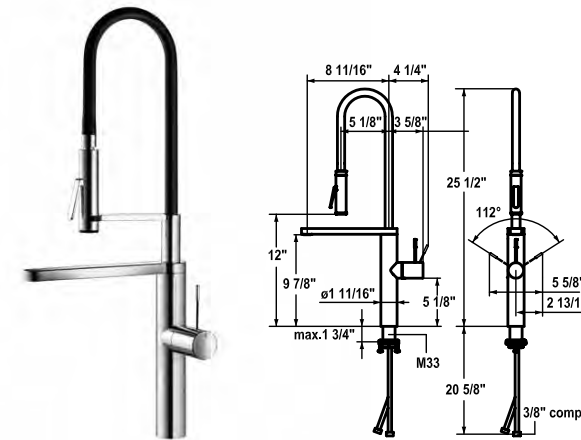

| | |
|-----------------------|----------------|
| 10.151.423.700 | \$3,870 |
| solid stainless steel | |
| 10.151.423.000 | \$2,955 |
| chrome | |

- Single-lever mixer - optional right or left side lever installation
- highflex spring hose technology allows flexibility in any direction
- Surgical-grade hardened stainless steel lever
- Integrated diverter
- caché® adjustable, hidden aerator reduces splash and side spray
- Professional 360° turn spray head
- KWC safety control 35mm ceramic cartridge
- Variable flow rate and temperature control
- Flow rate max 1.75 gpm (60 psi)
- Overall height 25 1/2"
- Spout swivel range 360°
- Spout reach from deck 8 11/16"
- Mounting hole size \varnothing 1 3/8"

ONO Pull-Out Faucet with jetclean

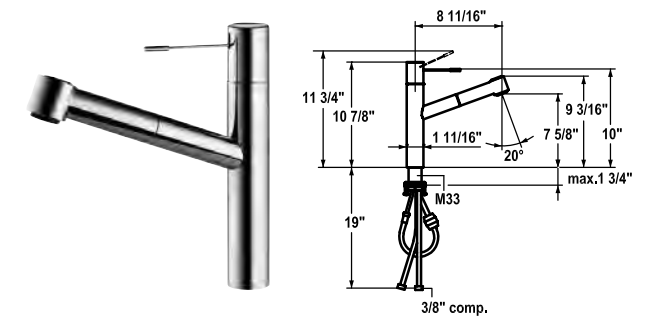

| | |
|-----------------------|----------------|
| 10.151.033.700 | \$1,675 |
| solid stainless steel | |
| 10.151.033.000 | \$1,160 |
| chrome | |

- Single-lever mixer
- jetclean technology prevents limescale deposits
- Surgical-grade hardened stainless steel lever
- Hose pull out length up to 28"
- Hose guide secures hose back into place
- KWC safety control 35mm ceramic cartridge
- Variable flow rate and temperature control
- Flow rate max 1.75 gpm (60 psi)
- Overall height 10 7/8"
- Spout swivel range 105°
- Spout reach from deck 8 11/16"
- Mounting hole size \varnothing 1 3/8"

ONO Pull-Down Faucet

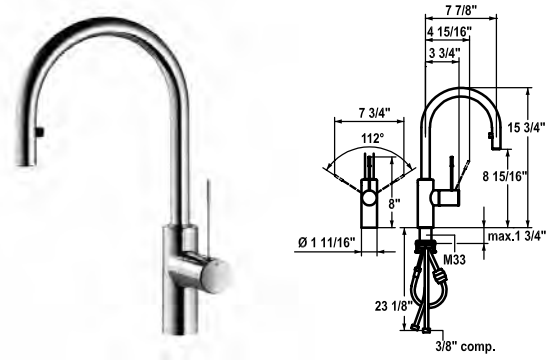

| | |
|-----------------------|----------------|
| 10.151.102.700 | \$1,535 |
| solid stainless steel | |
| 10.151.102.000 | \$1,190 |
| chrome | |

- Single-lever mixer - optional right or left side lever installation
- Surgical-grade hardened stainless steel lever
- caché® adjustable, hidden aerator reduces splash and side spray
- Hose pull out length up to 28"
- Hose guide secures hose back into place
- KWC safety control 35mm ceramic cartridge
- Variable flow rate and temperature control
- Flow rate max 1.75 gpm (60 psi)
- Overall height 15 3/4"
- Spout swivel range 360°
- Spout reach from deck 7 7/8"
- Mounting hole size \varnothing 1 3/8"

ONO Bar Faucet

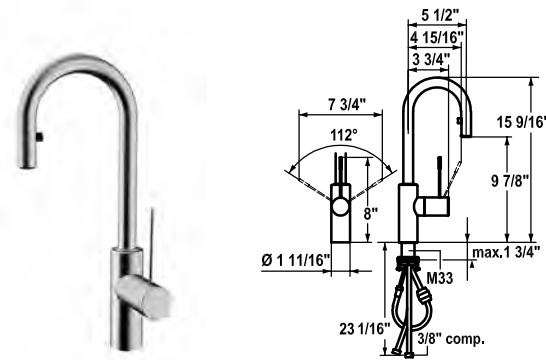

| | |
|-----------------------|----------------|
| 10.151.991.700 | \$1,505 |
| solid stainless steel | |
| 10.151.991.000 | \$1,160 |
| chrome | |

- Single-lever mixer - optional right or left side lever installation
- Surgical-grade hardened stainless steel lever
- caché® adjustable, hidden aerator reduces splash and side spray
- Hose pull out length up to 28"
- Hose guide secures hose back into place
- KWC safety control 35mm ceramic cartridge
- Variable flow rate and temperature control
- Flow rate max 1.75 gpm (60 psi)
- Overall height 15 5/8"
- Spout swivel range 360°
- Spout reach from deck 5 1/2"
- Mounting hole size \varnothing 1 3/8"

ONO Soap Dispenser

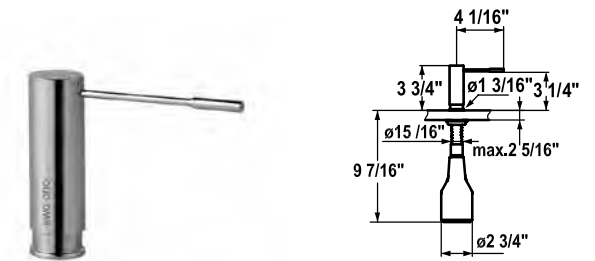

| | |
|-----------------------|--------------|
| Z.536.060.700 | \$580 |
| solid stainless steel | |
| Z.536.060.000 | \$425 |
| chrome | |

- Antimicrobial soap container
- Easy to use, one hand pump operation
- Refillable from surface, no need for removing soap container
- Large capacity bottle 11.8 fl oz. Z.635.713
- Mounting hole size \varnothing 1" - 1 3/8"
- Ordered separately:
Escutcheon Z.536.291.000



KWC SIN not only enables you to fulfill your aesthetic ambitions, it says something about your good sense too. After all, it enhances your kitchen with an extra touch of sensuality and intelligent functionality.

KWC **SIN**

SUBTLE INSPIRATION



HIGH-TECH AND HIGHLY FLEXIBLE

The innovative highflex spring hose from KWC opens your kitchen door to the future. This curved hose can be moved in any direction, returns to its original position automatically and stays firmly in place when it is not being used. If you place the spring hose in the spray holder with the help of a positioning aid, you can use it as a stable swivel spout that can be rotated 360°.



SIN highflex Professional Pull-Down Faucet

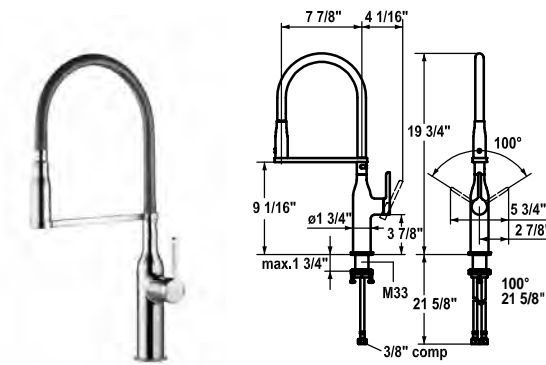

| | |
|---|----------------|
| 10.261.432.127 splendure™ stainless steel | \$1,840 |
| 10.261.432.000 chrome | \$1,400 |

- Single-lever mixer - optional right or left side lever installation
- highflex spring hose technology allows flexibility in any direction
- caché® adjustable, hidden aerator reduces splash and side spray
- Professional 360° turn toggle spray head
- Hose guide secures hose back into place
- KWC 25mm ceramic cartridge
- Variable flow rate and temperature control
- Flow rate max 1.75 gpm (60 psi)
- Overall height 19 3/4"
- Spout swivel range 360°
- Spout reach from deck 7 7/8"
- Mounting hole size \varnothing 1 3/8"

SIN Pull-Down Faucet with jetclean

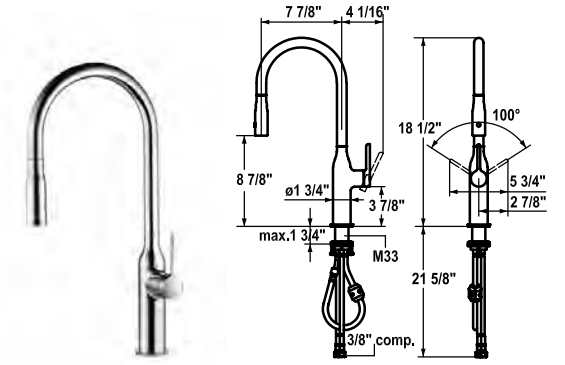

| | |
|---|----------------|
| 10.261.002.127 splendure™ stainless steel | \$1,470 |
| 10.261.002.000 chrome | \$1,160 |

- Single-lever mixer - optional right or left side lever installation
- jetclean technology prevents limescale deposits
- caché® adjustable, hidden aerator reduces splash and side spray
- Professional 360° pull-down spray head
- Hose pull out length up to 20"
- Hose guide secures hose back into place
- KWC 25mm ceramic cartridge
- Variable flow rate and temperature control
- Flow rate max 1.75 gpm (60 psi)
- Overall height 18 1/2"
- Spout swivel range 360°
- Spout reach from deck 7 7/8"
- Mounting hole size \varnothing 1 3/8"

SIN Prep Pull-Down Faucet

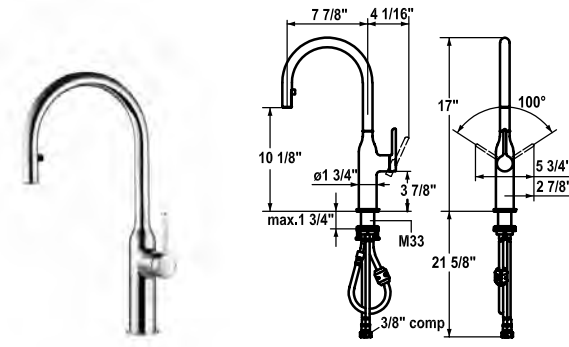

| | |
|----------------------------|----------------|
| 10.261.102.127 | \$1,290 |
| splendure™ stainless steel | |
| 10.261.102.000 | \$1,025 |
| chrome | |

- Single-lever mixer - optional right or left side lever installation
- caché® adjustable, hidden aerator reduces splash and side spray
- Hose pull out length up to 20"
- Hose guide secures hose back into place
- KWC 25mm ceramic cartridge
- Variable flow rate and temperature control
- Flow rate max 1.75 gpm (60 psi)
- Overall height 17"
- Spout swivel range 360°
- Spout reach from deck 7 7/8"
- Mounting hole size $\varnothing 1 \frac{3}{8}$ "

SIN Bar Faucet

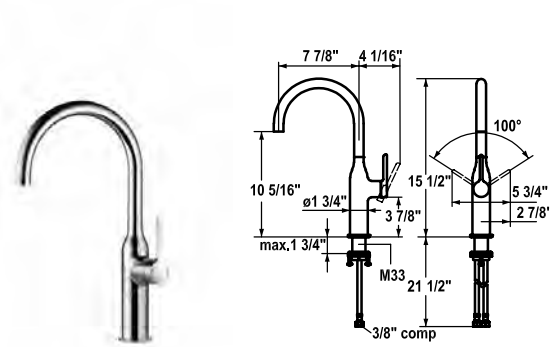

| | |
|----------------------------|----------------|
| 10.261.012.127 | \$1,240 |
| splendure™ stainless steel | |
| 10.261.012.000 | \$985 |
| chrome | |

- Single-lever mixer - optional right or left side lever installation
- caché® adjustable, hidden aerator reduces splash and side spray
- KWC 25mm ceramic cartridge
- Variable flow rate and temperature control
- Flow rate max 1.75 gpm (60 psi)
- Overall height 15 1/2"
- Spout swivel range 160°
- Spout reach from deck 7 7/8"
- Mounting hole size $\varnothing 1 \frac{3}{8}$ "

SIN Soap Dispenser

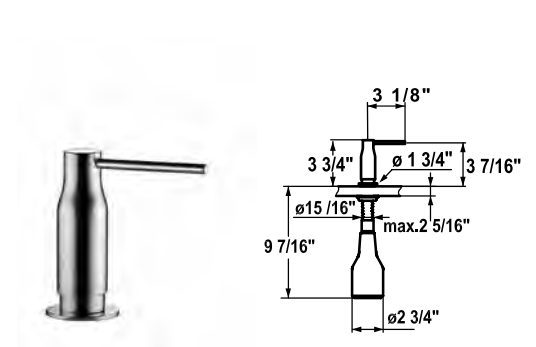

| | |
|----------------------------------|--------------|
| Z.536.332.127 | \$565 |
| splendure™ solid stainless steel | |
| Z.536.332.000 | \$455 |
| chrome | |

- Antimicrobial soap container
- Easy to use, one hand pump operation
- Refillable from surface, no need for removing soap container
- Large capacity bottle 11.8 fl oz. Z.635.713
- Mounting hole size $\varnothing 1 \frac{3}{8}$ "



KWC **EVE**

SIMPLE & ENERGY SAVING



AESTHETICS WITH FOCUS

Iridescent luminaqua LED lighting embedded into the pull-down aerator brings tranquil beauty to your kitchen. But the beauty transcends aesthetics alone and provides task lighting for your basin.



SLEEK AND FITTED

The pull-down spray with flexible hose is incorporated into the faucet design. Others will admire its beauty. You'll know how practical it really is.



Elegant and stylish yet practical, KWC EVE faucets combine sleek design with a 270-degree swivel spout and a 24-inch pull-down spray head. Integrated LED lights in the faucet head add aesthetics and illuminate your workspace.

EVE Pull-Down Faucet with luminaqua LED-Technology

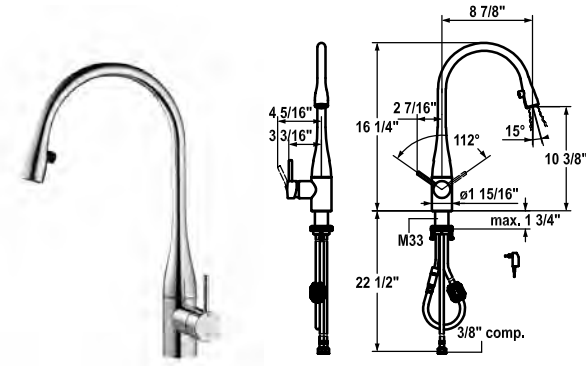

| | |
|-----------------------|----------------|
| 10.121.103.700 | \$1,805 |
| solid stainless steel | |
| 10.121.103.000 | \$1,535 |
| chrome | |

- Single-lever mixer - optional right or left side lever installation
- luminaqua LED light with integrated on/off switch
- Light switches off automatically after 45 minutes
- caché® adjustable aerator reduces splash and side spray
- Hose pull out length up to 24"
- Hose guide secures hose back into place
- KWC safety control 35mm ceramic cartridge
- Variable flow rate and temperature control
- Flow rate max 1.75 gpm (60 psi)
- Overall height 16 1/4"
- Spout swivel range 320°
- Spout reach from deck 8 7/8"
- Mounting hole size ø1 3/8"
- Power supply 100-240 V, operating voltage 6.75 V, power cord 43" in length

EVE Pull-Down Faucet

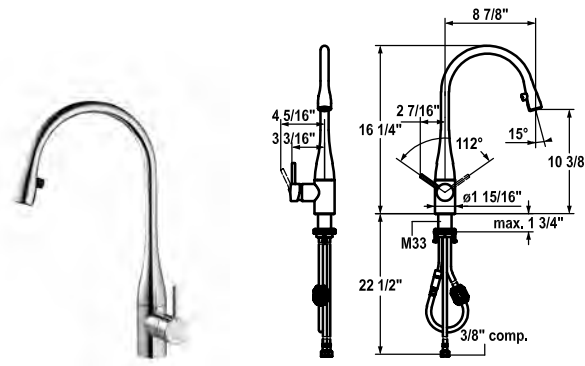

| | |
|-----------------------|----------------|
| 10.111.103.700 | \$1,535 |
| solid stainless steel | |
| 10.111.103.000 | \$1,285 |
| chrome | |

- Single-lever mixer - optional right or left side lever installation
- caché® adjustable aerator reduces splash and side spray
- Concealed pull-down spray head
- Hose pull out length up to 24"
- Hose guide secures hose back into place
- KWC safety control 35mm ceramic cartridge
- Variable flow rate and temperature control
- Flow rate max 1.75 gpm (60 psi)
- Overall height 16 1/4"
- Spout swivel range 320°
- Spout reach from deck 8 7/8"
- Mounting hole size ø1 3/8"

EVE Prep Pull-Down Faucet

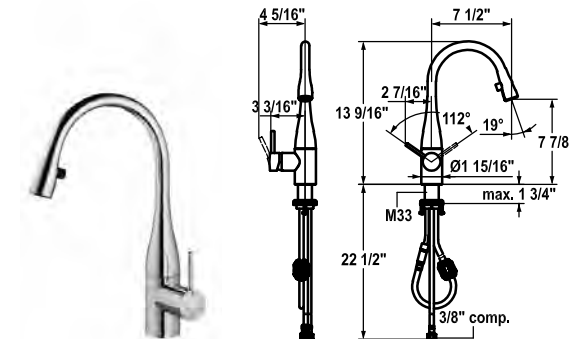

| | |
|-----------------------|----------------|
| 10.111.102.700 | \$1,535 |
| solid stainless steel | |
| 10.111.102.000 | \$1,240 |
| chrome | |

- Single-lever mixer - optional right or left side lever installation
- caché® adjustable aerator reduces splash and side spray
- Concealed pull-down spray head
- Hose pull out length up to 24"
- Hose guide secures hose back into place
- KWC safety control 35mm ceramic cartridge
- Variable flow rate and temperature control
- Flow rate max 1.75 gpm (60 psi)
- Overall height 13 9/16"
- Spout swivel range 320°
- Spout reach from deck 7 1/2"
- Mounting hole size ø1 3/8"

EVE Soap Dispenser

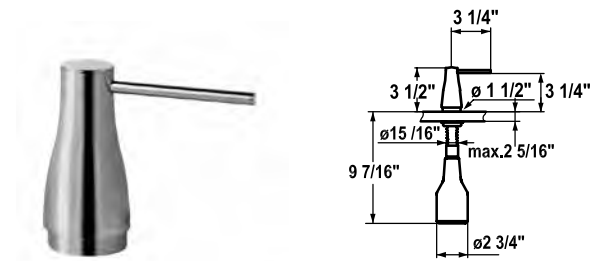

| | |
|-----------------------|--------------|
| Z.536.063.700 | \$580 |
| solid stainless steel | |
| Z.536.063.000 | \$410 |
| chrome | |

- Antimicrobial soap container
- Easy to use, one hand pump operation
- Refillable from surface, no need for removing soap container
- Large capacity bottle 11.8 fl oz. Z.635.713
- Mounting hole size ø1" - 1 3/8"
- Ordered separately:
Escutcheon Z.536.291.000

KWC SUPRIMO knows that you appreciate good performance. Made of stainless steel, this faucet is as immaculate and robust as its material suggests and is sure to set plenty of new standards in your kitchen – whether it is in terms of material quality, precision or elegance.



KWC SUPRIMO

A BODY FULL OF STEEL



TURN AND LOCK (TAL)

While most faucets revert to aerator mode when turned off, our Turn and Lock feature lets you lock-in the spray mode to effortlessly access the flow that's right for the job.

IN AND OUT

Our pull-out aerator extends 28 inches to add maximum flexibility to your faucet. It retracts automatically when not in use for true hands-free convenience.

SUPRIMO Tall Pull-Out Faucet with jetclean

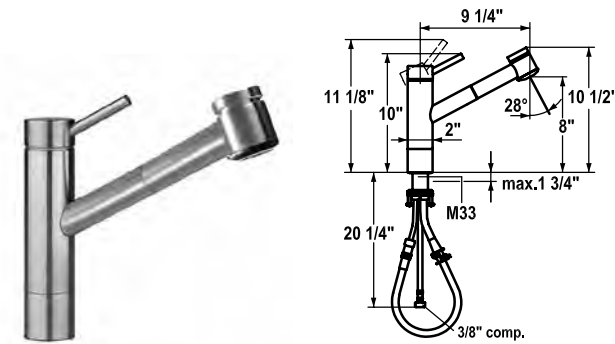

10.271.333.700
solid stainless steel

\$1,605

- Single-lever mixer with extended 1⁵/₈" height
- jetclean technology prevents limescale deposits
- Hose pull out length up to 28"
- Hose guide secures hose back into place
- KWC safety control 39mm ceramic cartridge
- Variable flow rate and temperature control
- Flow rate max 1.75 gpm (60 psi)
- Overall height 10"
- Spout swivel range 130°
- Spout reach from deck 9 1/4"
- Mounting hole size \varnothing 1 3/8"

SUPRIMO Pull-Out Faucet with jetclean

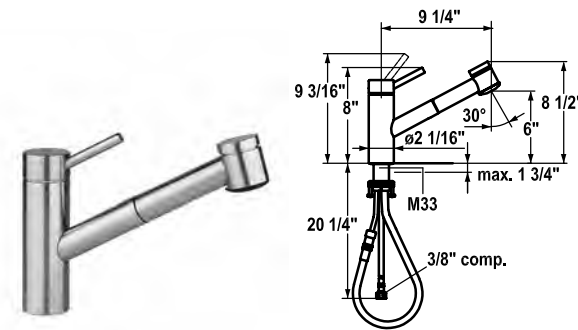

10.271.033.700
solid stainless steel

\$1,535

- Single-lever mixer
- jetclean technology prevents limescale deposits
- Lockable jet spray with automatic diverter reset
- Hose pull out length up to 28"
- Hose guide secures hose back into place
- KWC safety control 39mm ceramic cartridge
- Variable flow rate and temperature control
- Flow rate max 1.75 gpm (60 psi)
- Overall height 8"
- Spout swivel range 130°
- Spout reach from deck 9 1/4"
- Mounting hole size \varnothing 1 3/8"



SUPRIMO Tall Pull-Out Faucet

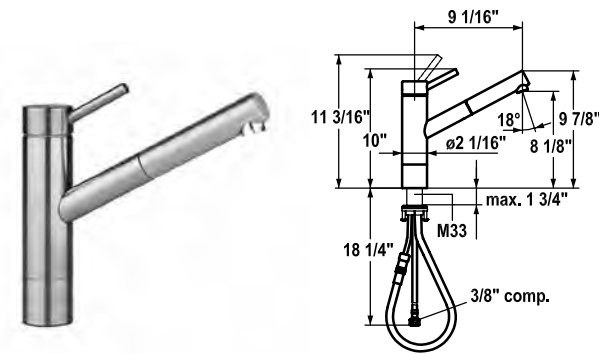

10.271.303.700

solid stainless steel

\$1,470

- Single-lever mixer with extended 1⁵/₁₆" height
- caché® adjustable aerator reduces splash and side spray
- Concealed pull-out spray head
- Hose pull out length up to 28"
- Hose guide secures hose back into place
- KWC safety control 39mm ceramic cartridge
- Variable flow rate and temperature control with limitation
- Flow rate max 1.75 gpm (60 psi)
- Overall height 10"
- Spout swivel range 130°
- Spout reach from deck 9 1/16"
- Mounting hole size \varnothing 1 3/8"

SUPRIMO Pull-Out Faucet

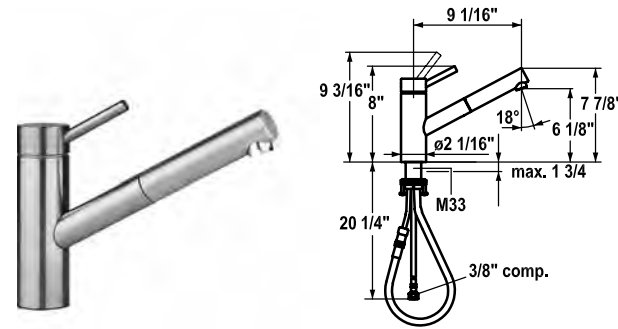

10.271.103.700

solid stainless steel

\$1,400

- Single-lever mixer
- Lockable jet spray with automatic diverter reset
- Hose pull out length up to 28"
- Hose guide secures hose back into place
- KWC safety control 39mm ceramic cartridge
- Variable flow rate and temperature control with limitation
- Flow rate max 1.75 gpm (60 psi)
- Overall height 8"
- Spout swivel range 130°
- Spout reach from deck 9 1/16"
- Mounting hole size \varnothing 1 3/8"

SUPRIMO Soap Dispenser

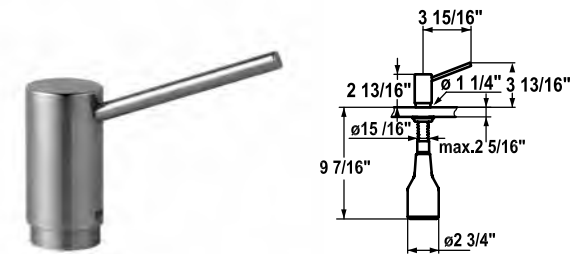

Z.536.062.700

solid stainless steel

\$580

- Antimicrobial soap container
- Easy to use, one hand pump operation
- Refillable from surface, no need for removing soap container
- Large capacity bottle 11.8 fl oz. Z.635.713
- Mounting hole size \varnothing 1" - 1 3/8"

KWC LIVELLO

THE PERFECT SHAPE

Choose right or left side lever installation and chrome or stainless steel finish. Continuously variable flow and temperature allow you to adjust the water to your precise needs. Unlike conventional faucets, LIVELLO is designed so that water flows colder when the handle is pulled forward, so it's child safe too.

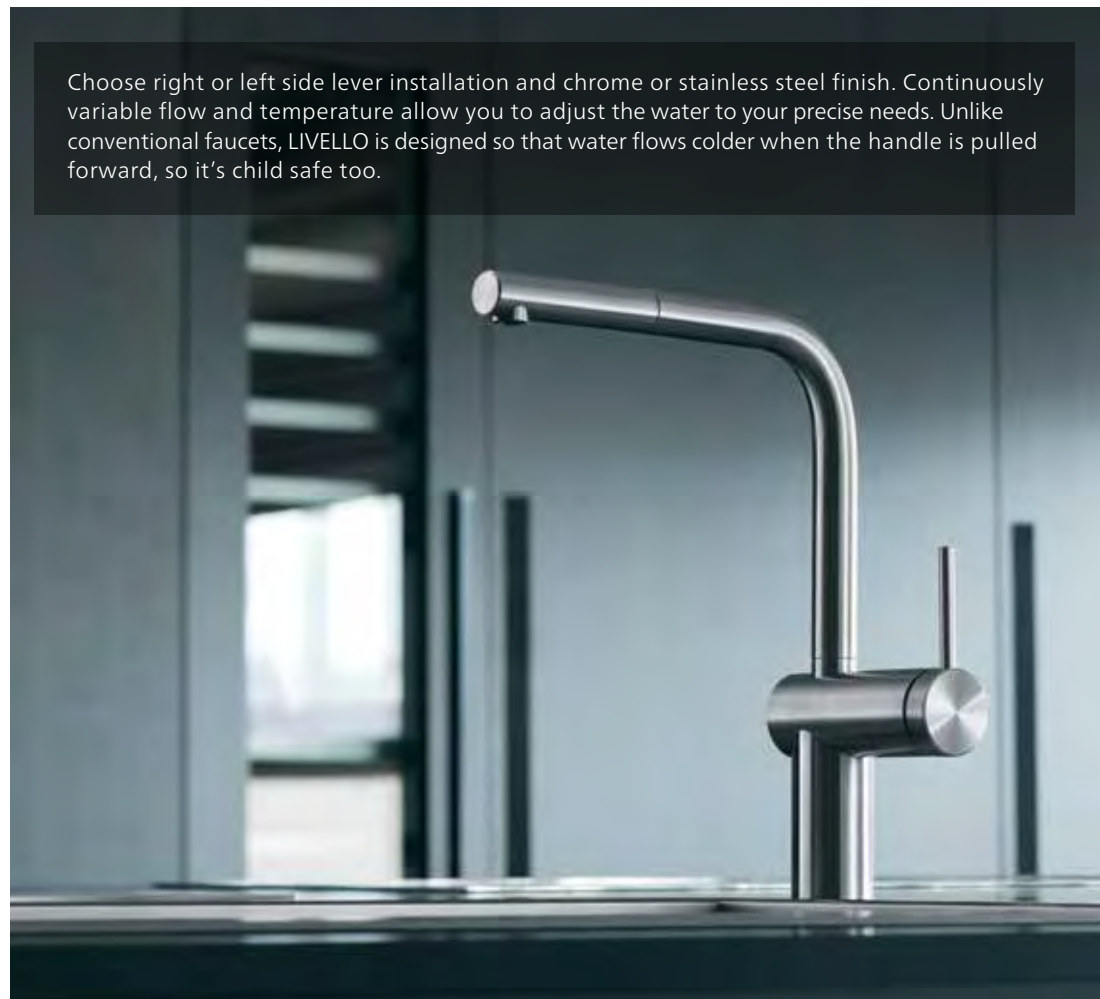

THICK AND THIN

Simple aesthetics, cleverly thought out down to the smallest detail: KWC LIVELLO is available in solid stainless steel or with a chrome finish, with an operating lever that forms a distinctive feature of its design.

LIVELLO

Pull-Out Faucet

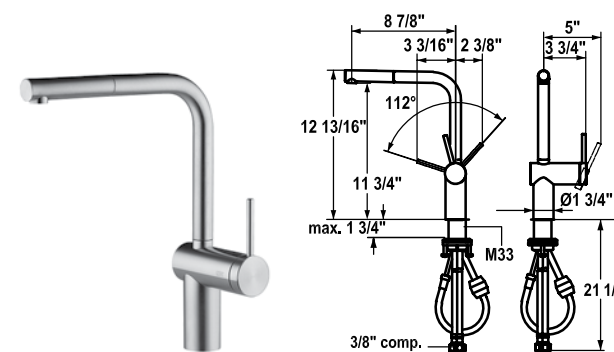

| | |
|-----------------------|----------------|
| 10.231.103.700 | \$1,400 |
| solid stainless steel | |
| 10.231.103.000 | \$1,160 |
| chrome | |

- Single-lever mixer - right side lever installation only
- Cold water flow positioned towards front for child safety
- caché® adjustable aerator reduces splash and side spray
- Hose pull out length up to 24"
- Hose guide secures hose back into place
- KWC safety control 35mm ceramic cartridge
- Variable flow rate and temperature control
- Flow rate max 1.75 gpm (60 psi)
- Overall height 12 13/16"
- Spout swivel range 360°
- Spout reach from deck 8 7/8"
- Mounting hole size \varnothing 1 3/8"



KWC AVA will satisfy both your fine sense of style and your requirement for reliable Swiss quality and state-of-the-art technology. With this faucet, you are sending out a clear message in your kitchen: Whoever lives here knows precisely what he or she wants.

KWC **AVA**

REDUCED TO THE PURE ESSENTIALS



UP AND DOWN

KWC AVA's flat lever has virtually become its trademark feature. It is based on a concealed mechanism that feels completely new, with the lever turning and rising simultaneously when you turn the faucet on.

AVA Pull-Out Faucet with jetclean

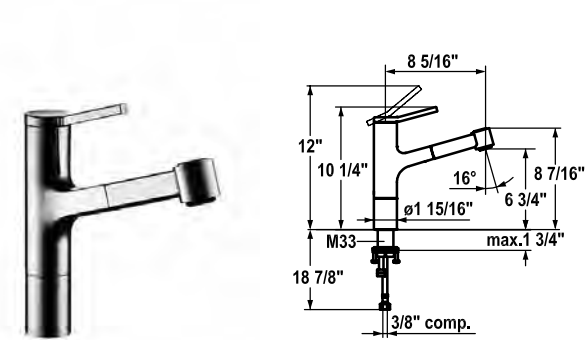

| | |
|----------------------------|----------------|
| 10.191.033.127 | \$1,160 |
| splendure™ stainless steel | |
| 10.191.033.000 | \$895 |
| chrome | |

- Single-lever mixer
- jetclean technology prevents limescale deposits
- Hose pull out length up to 28"
- Hose guide secures hose back into place
- KWC safety control 35mm ceramic cartridge
- Variable flow rate and temperature control
- Flow rate max 1.75 gpm (60 psi)
- Overall height 10 1/4"
- Spout swivel range 160°
- Spout reach from deck 8 5/16"
- Mounting hole size \varnothing 1 3/8"

AVA Pull-Out Faucet with jetclean

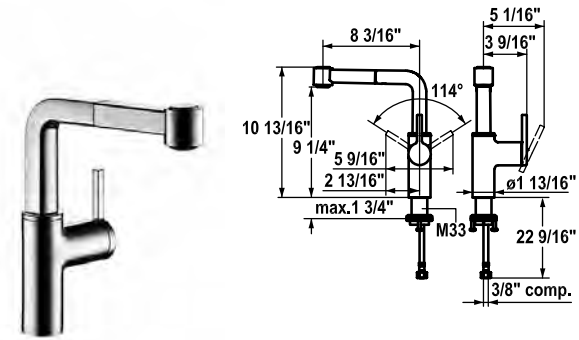

| | |
|----------------------------|----------------|
| 10.191.003.127 | \$1,160 |
| splendure™ stainless steel | |
| 10.191.003.000 | \$895 |
| chrome | |

- Single-lever mixer - optional right or left side lever installation
- jetclean technology prevents limescale deposits
- Hose pull out length up to 24"
- Hose guide secures hose back into place
- KWC safety control 35mm ceramic cartridge
- Variable flow rate and temperature control
- Flow rate max 1.75 gpm (60 psi)
- Overall height 10 13/16"
- Spout swivel range 360°
- Spout reach from deck 8 3/16"
- Mounting hole size \varnothing 1 3/8"



AVA Pull-Out Faucet

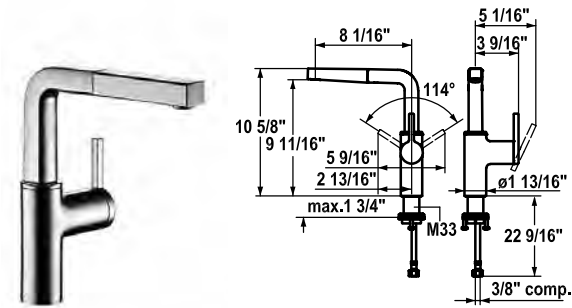

| | |
|----------------------------|----------------|
| 10.191.103.127 | \$1,090 |
| splendure™ stainless steel | |
| 10.191.103.000 | \$850 |
| chrome | |

- Single-lever mixer - optional right or left side lever installation
- caché® adjustable aerator reduces splash and side spray
- Hose pull out length up to 24"
- Hose guide secures hose back into place
- KWC safety control 35mm ceramic cartridge
- Variable flow rate and temperature control
- Flow rate max 1.75 gpm (60 psi)
- Overall height 10 5/8"
- Spout swivel range 360°
- Spout reach from deck 8 1/16"
- Mounting hole size 1 3/8"



AVA Soap Dispenser

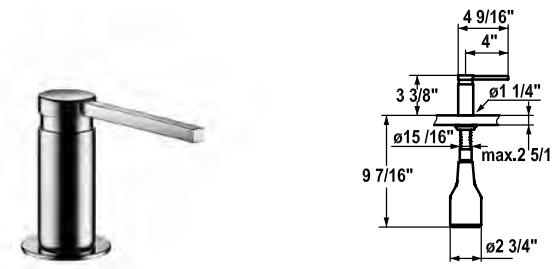

| | |
|----------------------------|--------------|
| Z.536.159.127 | \$390 |
| splendure™ stainless steel | |
| Z.536.159.000 | \$280 |
| chrome | |

- Antimicrobial soap container
- Easy to use, one hand pump operation
- Refillable from surface, no need for removing soap container
- Large capacity bottle 11.8 fl oz. Z.635.713
- Mounting hole size 1" - 1 3/8"

AVA Potfiller Service Faucet

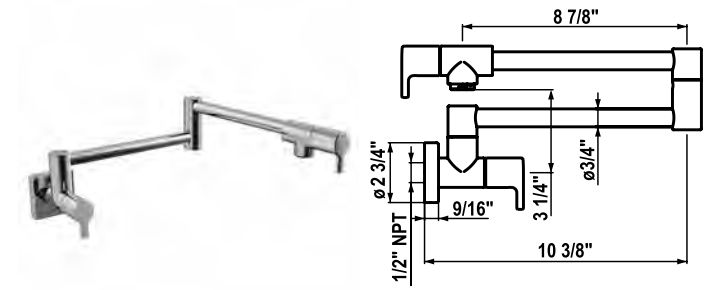

| | |
|----------------------------|--------------|
| 10.001.367.127 | \$840 |
| splendure™ stainless steel | |
| 10.001.367.000 | \$730 |
| chrome | |

- Dual swivel spout
- cascade® limescale protection aerator
- Spout extension 19"
- KWC safety control dual 1/4" turn ceramic cartridges
- Wall and spout shut-off
- Valves must be closed when faucet is left unattended
- Cold water only
- Flow rate max 2.2 gpm (60 psi)
- Connecting thread 1/2" FPT

KWC **DOMO**

A TRUE SYMBOL OF MODERNITY



TIGHTLY SEALED

This innovative sealing membrane keeps your faucets watertight for a long period of time. It protects the control cartridge from residue left by cleaning agents and dirt. The lever support is reinforced with a metal core and integrated into the membrane, reliably preventing the lever from coming loose.



The iconic KWC DOMO has been the faucet of choice in Switzerland for more than 30 years. With a commitment to retaining the original standard of quality, KWC has updated the DOMO series to offer today's consumers a classic faucet design that fits modern lifestyles.

DOMO

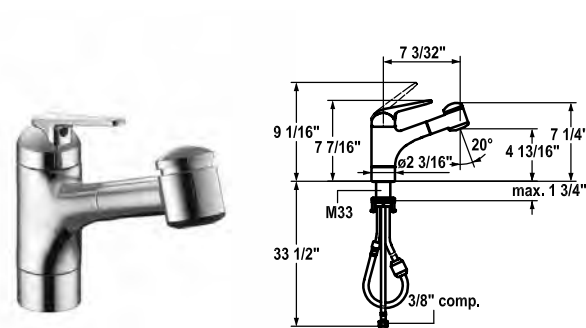
Pull-Out Faucet with flexguard & jetclean

| | |
|----------------------------|----------------|
| 10.061.032.127 | \$1,015 |
| splendure™ stainless steel | |
| 10.061.032.000 | \$800 |
| chrome | |

- Single-lever mixer
- flexguard sealing membrane protects faucet interior
- jetclean technology prevents limescale deposits
- Hose pull out length up to 28"
- Hose guide secures hose back into place
- Lockable spray
- KWC safety control 39mm ceramic cartridge
- Variable flow rate and temperature control with limitation
- Flow rate max 1.75 gpm (60 psi)
- Overall height 7 7/16"
- Spout swivel range 130°
- Spout reach from deck 7 3/32"
- Mounting hole size $\varnothing 1 \frac{3}{8}$ "

DOMO

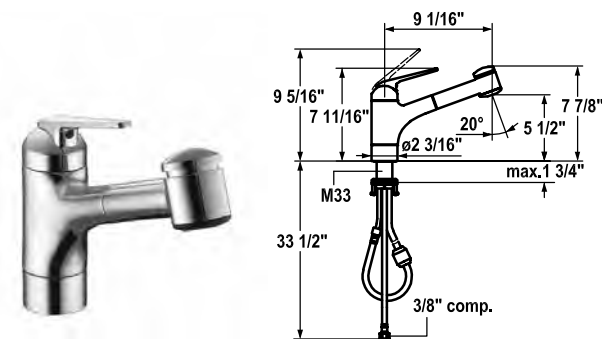
Pull-Out Faucet with flexguard & jetclean

| | |
|----------------------------|----------------|
| 10.061.033.127 | \$1,015 |
| splendure™ stainless steel | |
| 10.061.033.000 | \$800 |
| chrome | |

- Single-lever mixer
- flexguard sealing membrane protects faucet interior
- jetclean technology prevents limescale deposits
- Hose pull out length up to 28"
- Hose guide secures hose back into place
- Lockable spray
- KWC safety control 39mm ceramic cartridge
- Variable flow rate and temperature control with limitation
- Flow rate max 1.75 gpm (60 psi)
- Overall height 7 11/16"
- Spout swivel range 130°
- Spout reach from deck 9 1/16"
- Mounting hole size $\varnothing 1 \frac{3}{8}$ "

DOMO

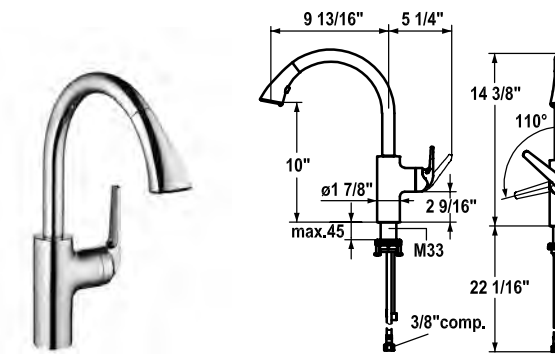
Pull-Down Faucet with flexguard

| | |
|----------------------------|----------------|
| 10.061.004.127 | \$1,015 |
| splendure™ stainless steel | |
| 10.061.004.000 | \$800 |
| chrome | |

- Single-lever mixer - right side lever installation only
- Cold water flow positioned towards front for child safety
- flexguard sealing membrane protects faucet interior
- jetclean technology prevents limescale deposits
- caché® adjustable aerator reduces splash and side spray
- Pull-down spray head with magnetic holder
- Hose pull out length up to 24"
- Hose guide secures hose back into place
- Acoustic group 1
- KWC safety control 39mm ceramic cartridge
- Variable flow rate and temperature control with limitation
- Flow rate max 1.75 gpm (60 psi)
- Overall height 14 3/8"
- Spout swivel range 360°
- Spout reach from deck 9 13/16"
- Mounting hole size $\varnothing 1 \frac{3}{8}$ "

DOMO

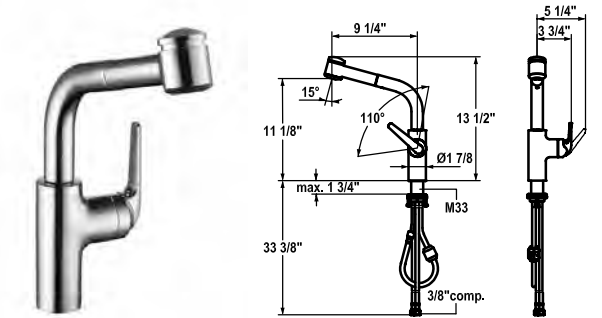
Pull-Out Faucet with flexguard & jetclean

| | |
|----------------------------|----------------|
| 10.061.003.127 | \$1,015 |
| splendure™ stainless steel | |
| 10.061.003.000 | \$800 |
| chrome | |

- Single-lever mixer - right side lever installation only
- Cold water flow positioned towards front for child safety
- flexguard sealing membrane protects faucet interior
- jetclean technology prevents limescale deposits
- Hose pull out length up to 28"
- Hose guide secures hose back into place
- Lockable spray
- KWC safety control 39mm ceramic cartridge
- Variable flow rate and temperature control with limitation
- Flow rate max 1.75 gpm (60 psi)
- Overall height 13 1/2"
- Spout swivel range 360°
- Spout reach from deck 9 1/4"
- Mounting hole size $\varnothing 1 \frac{3}{8}$ "

DOMO Bar Faucet with flexguard

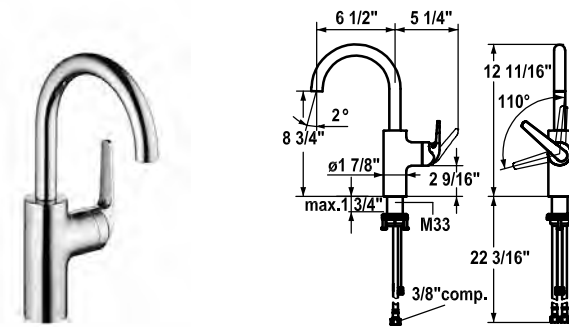

| | |
|----------------------------|--------------|
| 10.061.991.127 | \$730 |
| splendure™ stainless steel | |
| 10.061.991.000 | \$510 |
| chrome | |

- Single-lever mixer - right side lever installation only
- Cold water flow positioned towards front for child safety
- flexguard sealing membrane protects faucet interior
- caché® adjustable aerator reduces splash and side spray
- KWC safety control 39mm ceramic cartridge
- Variable flow rate and temperature control with limitation
- Flow rate max 1.75 gpm (60 psi)
- Overall height 12 11/16"
- Spout swivel range 160°
- Spout reach from deck 6 1/2"
- Mounting hole size \varnothing 1 3/8"



Innovation persists with LUNA-E faucets, which brings new benefits into the family while incorporating the much-loved features of its predecessor. Add in superior luxury and technology, and it emerges as a complementary style that pairs well with both contemporary and classic kitchens.



KWC LUNA-E MAKING EVERYDAY LIFE SPECIAL



JETCLEAN

The jetclean faceplate prevents limescale deposits in the kitchen spray and makes it easier to clean. The cone-shaped sieve holes expand when water flows and blasts off stubborn limescale deposits. The holes return to their normal size once the water is turned off.



MICRO SPRAY

This innovative feature allows you to direct water exactly where it is needed.

LUNA-E Pull-Down Faucet

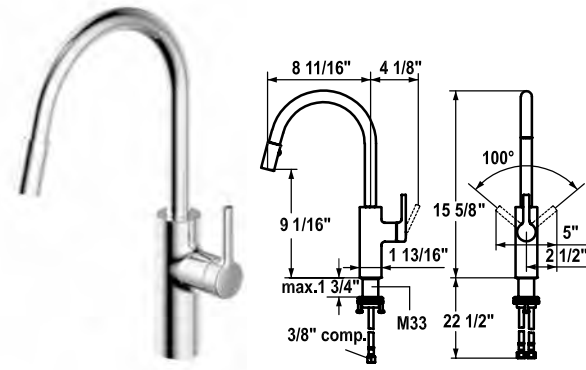

| | |
|----------------------------|--------------|
| 10.441.003.127 | \$830 |
| splendure™ stainless steel | |
| 10.441.003.000 | \$710 |
| chrome | |

- Single-lever mixer - right side lever installation only
- Cold water flow positioned towards front for child safety
- caché® adjustable aerator reduces splash and side spray
- Hose pull out length up to 24"
- Hose guide secures hose back into place
- KWC 25mm ceramic cartridge
- Variable flow rate and temperature control
- Flow rate max 1.75 gpm (60 psi)
- Overall height 15 5/8"
- Spout swivel range 360°
- Spout reach from deck 8 11/16"
- Mounting hole size \varnothing 1 3/8"

LUNA-E Pull-Out Faucet with jetclean

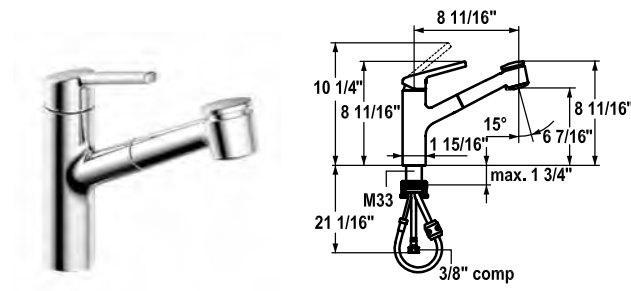

| | |
|----------------------------|--------------|
| 10.441.033.127 | \$760 |
| splendure™ stainless steel | |
| 10.441.033.000 | \$650 |
| chrome | |

- Single-lever mixer
- jetclean technology prevents limescale deposits
- Hose pull out length up to 24"
- Hose guide secures hose back into place
- KWC safety control 35mm ceramic cartridge
- Variable flow rate and temperature control
- Flow rate max 1.75 gpm (60 psi)
- Overall height 8 11/16"
- Spout swivel range 130°
- Spout reach from deck 8 11/16"
- Mounting hole size \varnothing 1 3/8"

LUNA-E Prep Faucet

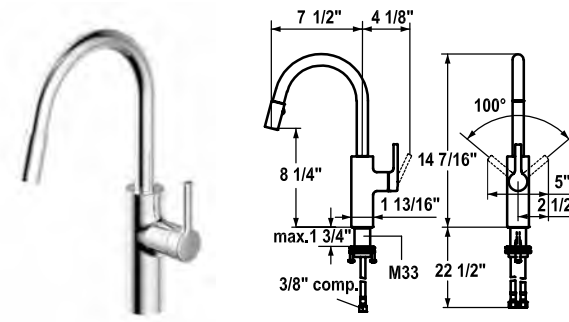

| | |
|----------------------------|--------------|
| 10.441.002.127 | \$760 |
| splendure™ stainless steel | |
| 10.441.002.000 | \$650 |
| chrome | |

- Single-lever mixer - right side lever installation only
- Cold water flow positioned towards front for child safety
- caché® adjustable aerator reduces splash and side spray
- Hose pull out length up to 24"
- Hose guide secures hose back into place
- KWC 25mm ceramic cartridge
- Variable flow rate and temperature control
- Flow rate max 1.75 gpm (60 psi)
- Overall height 14 7/16"
- Spout swivel range 360°
- Spout reach from deck 7 1/2"
- Mounting hole size \varnothing 1 3/8"

LUNA-E Bar Faucet

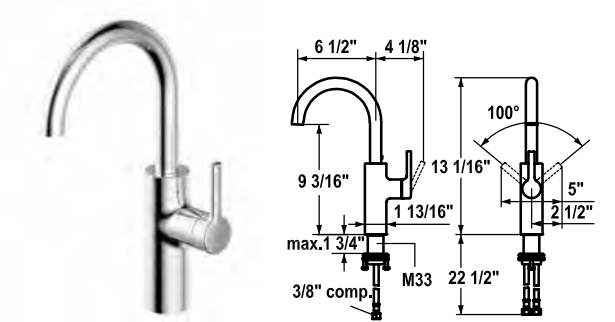

| | |
|----------------------------|--------------|
| 10.441.012.127 | \$600 |
| splendure™ stainless steel | |
| 10.441.012.000 | \$490 |
| chrome | |

- Single-lever mixer - right side lever installation only
- Cold water flow positioned towards front for child safety
- caché® adjustable aerator reduces splash and side spray
- KWC 25mm ceramic cartridge
- Variable flow rate and temperature control
- Flow rate max 1.75 gpm (60 psi)
- Overall height 13 1/16"
- Spout swivel range 160°
- Spout reach from deck 6 1/2"
- Mounting hole size \varnothing 1 3/8"

LUNA-E Cold Filtration Faucet

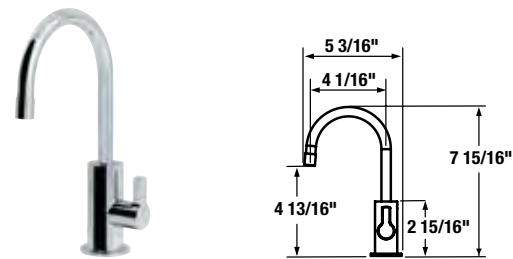

| | |
|----------------------------|--------------|
| 25.441.110.127 | \$610 |
| splendure™ stainless steel | |
| 25.441.110.000 | \$500 |
| chrome | |

- Single-lever mixer
- Cold water filtered only
- KWC 3/8" ceramic cartridge
- Variable flow rate and temperature control
- Flow rate max .5 gpm (60 psi)
- Overall height 7 15/16"
- Spout swivel range 360°
- Spout reach from deck 4 1/16"
- Mounting hole size \varnothing 1 1/4"

LUNA-E Hot Filtration Faucet

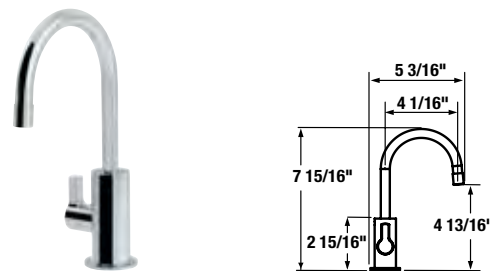

| | |
|----------------------------|--------------|
| 25.441.120.127 | \$610 |
| splendure™ stainless steel | |
| 25.441.120.000 | \$500 |
| chrome | |

- Single-lever mixer
- Hot water filtered only
- KWC 3/8" ceramic cartridge
- Variable flow rate and temperature control
- Flow rate max .5 gpm (60 psi)
- Overall height 7 15/16"
- Spout swivel range 360°
- Spout reach from deck 4 1/16"
- Mounting hole size \varnothing 1 1/4"

LUNA-E Hot/Cold Filtration Faucet

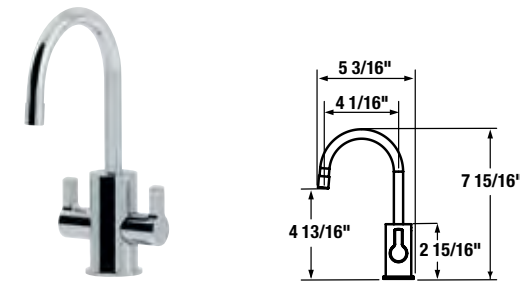

| | |
|----------------------------|--------------|
| 25.441.130.127 | \$740 |
| splendure™ stainless steel | |
| 25.441.130.000 | \$640 |
| chrome | |

- Double-lever mixer
- Hot and cold water filtration
- KWC 3/8" ceramic cartridge
- Variable flow rate and temperature control
- Flow rate max .5 gpm (60 psi)
- Overall height 7 15/16"
- Spout swivel range 360°
- Spout reach from deck 4 1/16"
- Mounting hole size \varnothing 1 1/4"

LUNA-E Potfiller Service Faucet

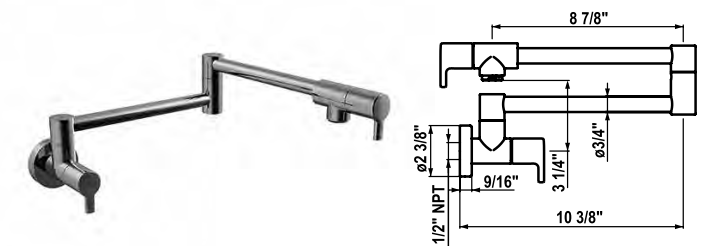

| | |
|----------------------------|--------------|
| 10.001.357.127 | \$870 |
| splendure™ stainless steel | |
| 10.001.357.000 | \$760 |
| chrome | |

- Dual swivel spout
- cascade® limescale protection aerator
- Spout extension 19"
- KWC safety control dual 1/4" turn ceramic cartridges
- Wall and spout shut-off
- Valves must be closed when faucet is left unattended
- Cold water only
- Flow rate max 2.2 gpm (60 psi)
- Connecting thread 1/2" FPT

KWC POTFILLERS



AVA Potfiller Service Faucet

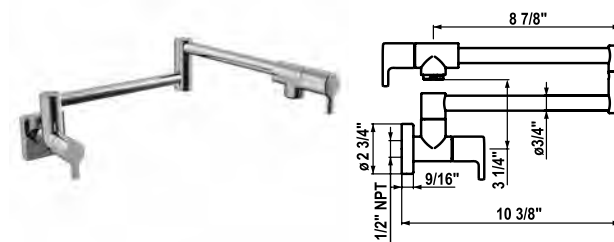

| | |
|----------------------------|--------------|
| 10.001.367.127 | \$840 |
| splendure™ stainless steel | |
| 10.001.367.000 | \$730 |
| chrome | |

- Dual swivel spout
- cascade® limescale protection aerator
- Spout extension 19"
- KWC safety control dual ¼" turn ceramic cartridges
- Wall and spout shut-off
- Valves must be closed when faucet is left unattended
- Cold water only
- Flow rate max 2.2 gpm (60 psi)
- Connecting thread ½" FPT

LUNA-E Potfiller Service Faucet

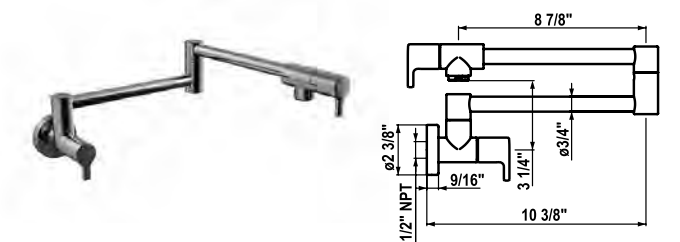

| | |
|----------------------------|--------------|
| 10.001.357.127 | \$870 |
| splendure™ stainless steel | |
| 10.001.357.000 | \$760 |
| chrome | |

- Dual swivel spout
- cascade® limescale protection aerator
- Spout extension 19"
- KWC safety control dual ¼" turn ceramic cartridges
- Wall and spout shut-off
- Valves must be closed when faucet is left unattended
- Cold water only
- Flow rate max 2.2 gpm (60 psi)
- Connecting thread ½" FPT

KWC SOAP DISPENSERS



ERA Soap Dispenser

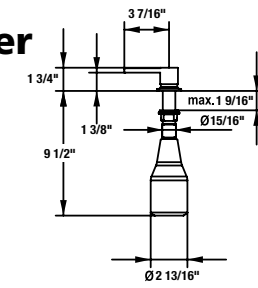

Z.538.038.700

solid stainless steel

\$540

- Antimicrobial soap container
- Easy to use, one hand pump operation
- Refillable from surface, no need for removing soap container
- Large capacity bottle 11.8 fl oz. Z.538.053
- Mounting hole size $\varnothing 1''$

ZOE Soap Dispenser

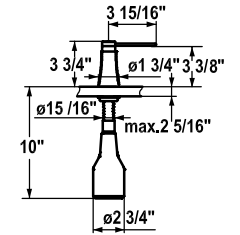

Z.536.586.127

splendure™ stainless steel

\$605

Z.536.586.000

chrome

\$495

Z.536.586.176

matte black

\$505

- Antimicrobial soap container
- Easy to use, one hand pump operation
- Refillable from surface, no need for removing soap container
- Large capacity bottle 11.8 fl oz. Z.635.713
- Mounting hole size $\varnothing 1'' - 1 \frac{3}{8}''$
- Ordered separately:
Escutcheon Z.536.291.000

ONO Soap Dispenser

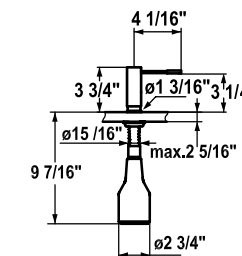

Z.536.060.700

solid stainless steel

\$580

Z.536.060.000

chrome

\$425

- Antimicrobial soap container
- Easy to use, one hand pump operation
- Refillable from surface, no need for removing soap container
- Large capacity bottle 11.8 fl oz. Z.635.713
- Mounting hole size $\varnothing 1'' - 1 \frac{3}{8}''$
- Ordered separately:
Escutcheon Z.536.291.000

EVE Soap Dispenser

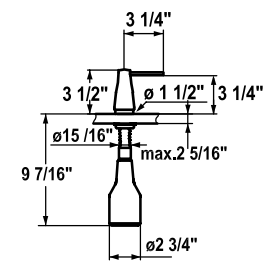

Z.536.063.700

solid stainless steel

\$580

Z.536.063.000

chrome

\$410

- Antimicrobial soap container
- Easy to use, one hand pump operation
- Refillable from surface, no need for removing soap container
- Large capacity bottle 11.8 fl oz. Z.635.713
- Mounting hole size $\varnothing 1'' - 1 \frac{3}{8}''$
- Ordered separately:
Escutcheon Z.536.291.000

AVA Soap Dispenser

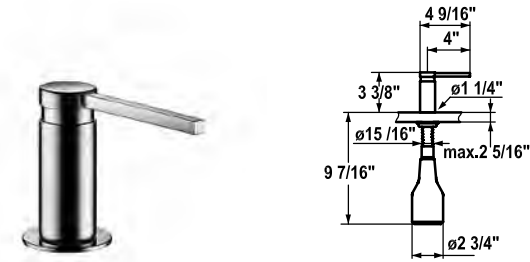

Z.536.159.127 **\$390**
splendure™ stainless steel

Z.536.159.000 **\$280**
chrome

- Antimicrobial soap container
- Easy to use, one hand pump operation
- Refillable from surface, no need for removing soap container
- Large capacity bottle 11.8 fl oz. Z.635.713
- Mounting hole size $\varnothing 1'' - 1 \frac{3}{8}''$

SUPRIMO Soap Dispenser

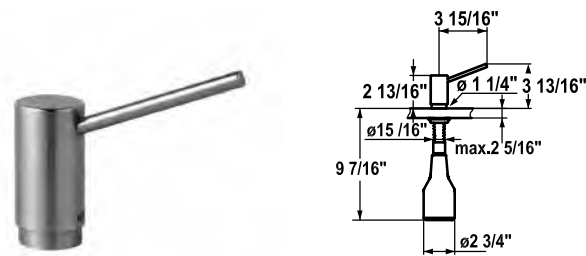

Z.536.062.700 **\$580**
solid stainless steel

- Antimicrobial soap container
- Easy to use, one hand pump operation
- Refillable from surface, no need for removing soap container
- Large capacity bottle 11.8 fl oz. Z.635.713
- Mounting hole size $\varnothing 1'' - 1 \frac{3}{8}''$

SIN Soap Dispenser

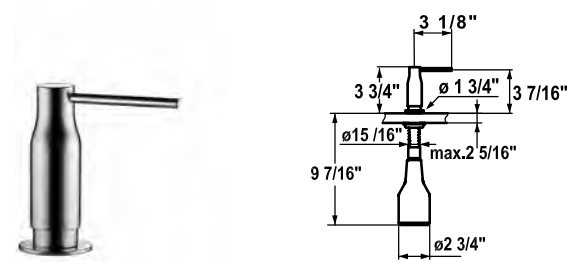

Z.536.332.127 **\$565**
splendure™ stainless steel

Z.536.332.000 **\$455**
chrome

- Antimicrobial soap container
- Easy to use, one hand pump operation
- Refillable from surface, no need for removing soap container
- Large capacity bottle 11.8 fl oz. Z.635.713
- Mounting hole size $\varnothing 1'' - 1 \frac{3}{8}''$

PRIMO Soap Dispenser



Z.504.938.127 **\$345**
splendure™ stainless steel

Z.504.938.700 **\$280**
solid stainless steel

Z.504.938.000 **\$195**
chrome

- Antimicrobial soap container
- Easy to use, one hand pump operation
- Refillable from surface, no need for removing soap container
- Large capacity bottle 11.8 fl oz. Z.635.713
- Mounting hole size $\varnothing 1'' - 1 \frac{3}{8}''$

Spare Parts

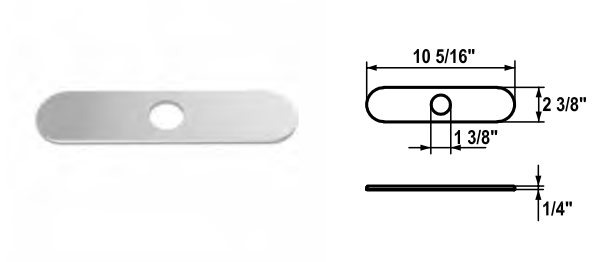

Z.535.307.127 **\$100**
splendure™ stainless steel

Z.535.307.000 **\$80**
chrome

- Cover plate used with single-hole mixers to cover unused mounting holes
- 3-hole

BASIC Soap Dispenser



Z.504.937.000 **\$115**
chrome

- Antimicrobial soap container
- Easy to use, one hand pump operation
- Refillable from surface, no need for removing soap container
- Large capacity bottle 11.8 fl oz. Z.635.713
- Mounting hole size $\varnothing 1'' - 1 \frac{3}{8}''$

GENERAL

- Products may only be sold and advertised within the United States of America. Franke/KWC hereby expressly prohibits the dealer from soliciting or consummating sales outside of the United States of America without prior written consent.
- Products shall only be sold in their original packaging. Relabeling, repackaging (including the separation of bundled products or the bundling of separate products), and other alterations are not permitted.
- Sale of Franke/KWC products on the Internet shall be prohibited unless resellers apply and are approved by Franke/KWC, and execute an Authorized Internet Reseller Agreement regulating the manner in which they sell online.

ORDERING

- Once an order has been acknowledged, no changes (including additions or cancellations) will be accepted.
- Order acknowledgments are available via email. An email address must be provided to receive this benefit.
- Standard lead time for shipment is one to five (1-5) business days from receipt of order.

STANDARD PAYMENT TERMS

- Net 30 days.
- Early payment discounts are not applicable for payments via credit card.
- Franke/KWC reserves the right to charge interest and an administration fee on late payments.

PRICING

- Please refer to the electronically published price list (EPL). Orders will be priced with the prevailing price at the time the order is placed.
- Prices are subject to change without notice. Franke/KWC will attempt to provide reasonable lead time for pricing changes.

CLAIMS/CHARGE BACKS

- Damages/Shortages must be reported within ten (10) days of receipt of merchandise.
- Charge backs will not be accepted without an authorization number (RMA), provided by a Regional Sales Manager, Distributor, or Customer Service.

RETURNS

- No returns will be accepted without a return authorization number (RMA).
- Return authorization requests must be submitted through Rep/Regional Manager.
- A 25% restocking fee will be charged for ALL returns of product that was not damaged or mis-shipped.
- No returns will be accepted more than 180 days from original invoice date.
- No returns will be accepted on discontinued (DWO) or obsolete product.
- Franke/KWC reserves the right to refuse returns without reason.

FREIGHT

Pre-paid freight/Free freight allowance (FFA)

- USD 2,900 is the minimum order value for FFA
- All product lines, including parts, can be included in freight qualification calculations.
- All Display and Literature orders will be shipped with pre-paid freight status.

Flat Rate Shipping

- Any order shipping parcel containing standard products will ship for \$25 flat.
- Orders >150 lbs. are shipping LTL and are charged according to weight/dimension.
- Orders containing Fireclay sinks are charged USD 150 for up to 2 units and USD 300 for up to 4 units.
- Other: standard shipping rates apply for Fireclay orders greater than 4 units and any parts only orders.

Other freights terms

- Franke/KWC will attempt to fulfill requests to expedite shipping. Customers will be responsible for additional freight charges. Contact Customer Service for all expedited shipping requests.
- Drop shipment of internet orders is not available. All Internet Sales must be shipped from an Authorized Internet Reseller's location. Drop shipment is offered within 100 miles of customer's place of business, or within customer's state or a bordering state.

BACK ORDERS

- Back order shipments will match freight qualifying status of original order.
- Back ordered product will be considered an active order unless customer requests cancellation.

LIMITED WARRANTY

FAUCETS

Franke/KWC warrants that mechanical parts in all faucets purchased after January 1, 2003, will be free of manufacturing defects in material and workmanship for the lifetime of the faucet. Faucets purchased prior to 2003 are subject to the warranty in place at time of purchase. Franke/KWC warrants that (1) the chrome finishes on Franke/KWC faucets will be free of manufacturing defect for the lifetime of the faucet; and (2) all other finishes on Franke/KWC faucets will be free of manufacturing defect for five (5) years from the original date of purchase.

LOTION/SOAP DISPENSERS

Franke/KWC warrants that Franke/KWC lotion/soap dispensers are free from manufacturing defects in material and workmanship for a period of 5 years from the date of purchase. Such warranty does not cover damage caused by the use of aggressive soaps and lotions.

OUTDOOR INSTALLATION

Certain Franke/KWC faucets are warranted to be free from manufacturing defects in material and workmanship for outdoor installations for the period set forth in the paperwork included with the product, which is 5 or 10 years from the date of purchase, depending on the model purchased.

WARRANTY TERMS

Each warranty by Franke Kitchen System, LLC ("Franke")/KWC set forth herein (each, a "Warranty" and collectively the "Warranties") applies only to the original owner when purchased from Franke/KWC or a Franke/KWC authorized reseller. The Warranties only apply if the applicable product has been installed in accordance with our installation instructions, used as recommended and in a normal residential application. To make a warranty claim, the owner must provide proof of purchase, in the form of a sales receipt. Each Warranty covers all components that make the applicable product operational. Franke/KWC, at its option, may repair or replace the product or components necessary to restore the product to good working condition. Franke/KWC reserves the right to inspect the installation prior to the actual replacement of the product or component part. The Warranties do not cover any product used in combination with a Reverse Osmosis Filtration System.

The Warranties do not cover misuse or abuse, accidental damages, scuffs or scratches, improper installation, abnormal usage, negligence, damage caused by improper maintenance or cleaning or normal wear. Damage caused by impurities or acts beyond Franke's/KWC's control are not covered by any Warranty. Further, this warranty does not cover any products purchased from unauthorized dealers. If any product or part has been repaired or altered in any manner outside of Franke's/KWC's factory, unless previously authorized in writing by Franke/KWC, the applicable Warranty is void with respect to such product or part. Owner of a product will be liable for any transportation and re-installation costs related to any Warranty for such product. The Warranties do not allow recovery of incidental or consequential damages such as loss of use, delay, property damage or other consequential damage, and Franke/KWC accepts no liability for such damages.

Each Warranty is limited to the conditions set forth herein and to the applicable warranty period specified herein and is exclusive. EXCEPT FOR THE WARRANTIES SET FORTH HEREIN, FRANKE/KWC MAKES NO WARRANTY WHATSOEVER WITH RESPECT TO THE PRODUCTS, INCLUDING, BUT NOT LIMITED TO, (1) ANY WARRANTY OF MERCHANTABILITY, (2) WARRANTY OF FITNESS FOR A PARTICULAR PURPOSE, (3) WARRANTY OF TITLE, OR (4) WARRANTY AGAINST INFRINGEMENT OF INTELLECTUAL PROPERTY RIGHTS OF A THIRD PARTY, WHETHER EXPRESS OR IMPLIED BY LAW, COURSE OF DEALING, COURSE OF PERFORMANCE, USAGE OF TRADE OR OTHERWISE.

LEGAL DISCLAIMER

PLEASE READ CAREFULLY.

Franke Kitchen Systems/KWC provides the above information to you as a public service to our customers. By accessing and using this information, you agree to the following and to comply with all applicable laws. If you do not agree with these terms and conditions, do not use this information. While we try to keep the information current, changes may have occurred since its creation. Contact your Regional Manager or Customer Service to verify information regarding Franke Kitchen Systems/KWC programs and their use by you.

Copyright and Other Intellectual Property Rights. This document and our website are protected by copyright pursuant to U.S. copyright laws, international treaties, and other copyright laws. This document and our website contains copyrighted material, trademarks, and other proprietary information of Franke Consumer Products, Inc./KWC and Franke Kitchen Systems, LLC/KWC and others (collectively "Proprietary Material"), which may include, but shall not be limited to: text, software, photos, video, graphics, images, music and sound. You may not modify, publish, copy, transmit, participate in the transfer or sale of, create derivative works of, or in any way exploit, in whole or in part, any Proprietary Material without the prior written authorization of Franke Kitchen Systems/KWC or the applicable rights holder.

Changes. We may change these terms and any part (or all) of the information enclosed at any time without notice. Any changes will apply to your future use, so you should contact your Regional Manager or Customer Service periodically. If you use this information after any changes to these terms, then you accept those changes.

Choice of Law. We are a Delaware limited liability company and these Terms and Conditions, and the purchase of products from Franke Kitchen Systems/KWC, shall be governed by the substantive laws of the State of Delaware, including the Uniform Commercial Code as adopted in Delaware, and the United Nations Convention on Contracts for the International Sale of Goods shall not apply. Any cause of action must be commenced within one year after the claim or cause of action arises. If a court of competent jurisdiction holds these terms and conditions or any part of them to be invalid, then that part shall be enforced to the maximum extent possible and the remainder of these terms and conditions will remain in full force and effect.

HOW TO CONTACT US

CONTACT INFORMATION:

Customer Service: 888-592-3287
 Customer Service FAX: 888-685-0007
 Customer Service Email: kwcsupport@kwcamerica.com
 Marketing Services: 800-626-5771
 Marketing Services Email: ks-marketingservices.us@franke.com

Franke Kitchen Systems
 800 Aviation Parkway
 Smyrna, TN 37167

INDEX

| KITCHEN | PAGE | PRICE | KITCHEN | PAGE | PRICE |
|----------------|--------|---------|----------------|--------|---------|
| 10.001.357.000 | 73, 75 | \$760 | 10.261.102.127 | 42 | \$1,290 |
| 10.001.357.127 | 73, 75 | \$870 | 10.261.432.000 | 41 | \$1,400 |
| 10.001.367.000 | 61, 75 | \$730 | 10.261.432.127 | 41 | \$1,840 |
| 10.001.367.127 | 61, 75 | \$840 | 10.271.033.700 | 50 | \$1,535 |
| 10.061.003.000 | 65 | \$800 | 10.271.103.700 | 52 | \$1,400 |
| 10.061.003.127 | 65 | \$1,015 | 10.271.303.700 | 52 | \$1,470 |
| 10.061.004.000 | 65 | \$800 | 10.271.333.700 | 50 | \$1,605 |
| 10.061.004.127 | 65 | \$1,015 | 10.392.022.700 | 18 | \$1,420 |
| 10.061.032.000 | 64 | \$800 | 10.392.023.700 | 18 | \$1,420 |
| 10.061.032.127 | 64 | \$1,015 | 10.392.024.700 | 17 | \$1,640 |
| 10.061.033.000 | 64 | \$800 | 10.392.323.700 | 17 | \$1,750 |
| 10.061.033.127 | 64 | \$1,015 | 10.441.002.000 | 71 | \$650 |
| 10.061.991.000 | 66 | \$510 | 10.441.002.127 | 71 | \$760 |
| 10.061.991.127 | 66 | \$ 730 | 10.441.003.000 | 70 | \$710 |
| 10.111.102.000 | 47 | \$1,240 | 10.441.003.127 | 70 | \$830 |
| 10.111.102.700 | 47 | \$1,535 | 10.441.012.000 | 71 | \$490 |
| 10.111.103.000 | 46 | \$1,285 | 10.441.012.127 | 71 | \$600 |
| 10.111.103.700 | 46 | \$1,535 | 10.441.033.000 | 70 | \$650 |
| 10.121.103.000 | 46 | \$1,535 | 10.441.033.127 | 70 | \$760 |
| 10.121.103.700 | 46 | \$1,805 | 10.651.122.000 | 30 | \$5,155 |
| 10.151.033.000 | 35 | \$1,160 | 25.441.110.000 | 72 | \$500 |
| 10.151.033.700 | 35 | \$1,675 | 25.441.110.127 | 72 | \$610 |
| 10.151.102.000 | 36 | \$1,190 | 25.441.120.000 | 72 | \$500 |
| 10.151.102.700 | 36 | \$1,535 | 25.441.120.127 | 72 | \$610 |
| 10.151.423.000 | 35 | \$2,955 | 25.441.130.000 | 73 | \$640 |
| 10.151.423.700 | 35 | \$3,870 | 25.441.130.127 | 73 | \$740 |
| 10.151.991.000 | 36 | \$1,160 | Z.504.937.000 | 79 | \$115 |
| 10.151.991.700 | 36 | \$1,505 | Z.504.938.000 | 78 | \$195 |
| 10.191.003.000 | 58 | \$895 | Z.504.938.127 | 78 | \$345 |
| 10.191.003.127 | 58 | \$1,160 | Z.504.938.700 | 78 | \$280 |
| 10.191.033.000 | 58 | \$895 | Z.535.307.000 | 79 | \$80 |
| 10.191.033.127 | 58 | \$1,160 | Z.535.307.127 | 79 | \$100 |
| 10.191.103.000 | 60 | \$850 | Z.536.060.000 | 37, 77 | \$425 |
| 10.191.103.127 | 60 | \$1,090 | Z.536.060.700 | 37, 77 | \$580 |
| 10.201.102.000 | 26 | \$1,280 | Z.536.062.700 | 53, 78 | \$580 |
| 10.201.102.127 | 26 | \$1,645 | Z.536.063.000 | 47, 77 | \$410 |
| 10.201.102.176 | 26 | \$1,465 | Z.536.063.700 | 47, 77 | \$580 |
| 10.201.122.000 | 26 | \$1,535 | Z.536.159.000 | 61, 78 | \$280 |
| 10.201.122.127 | 26 | \$1,915 | Z.536.159.127 | 61, 78 | \$390 |
| 10.201.122.176 | 26 | \$1,755 | Z.536.332.000 | 43, 78 | \$455 |
| 10.201.242.000 | 22 | \$2,910 | Z.536.332.127 | 43, 78 | \$565 |
| 10.201.242.127 | 22 | \$3,460 | Z.536.352 | 31 | \$102 |
| 10.201.242.176 | 22 | \$3,210 | Z.536.586.000 | 27, 77 | \$495 |
| 10.231.103.000 | 55 | \$1,160 | Z.536.586.127 | 27, 77 | \$605 |
| 10.231.103.700 | 55 | \$1,400 | Z.536.586.176 | 27, 77 | \$505 |
| 10.261.002.000 | 41 | \$1,160 | Z.536.638.000 | 30 | \$1,917 |
| 10.261.002.127 | 41 | \$1,470 | Z.538.038.700 | 19, 77 | \$540 |
| 10.261.012.000 | 42 | \$985 | Z.636.183 | 31 | \$20 |
| 10.261.012.127 | 42 | \$1,240 | | | |
| 10.261.102.000 | 42 | \$1,025 | | | |



888-592-3287
kwc.com/us

KWC

Franke Kitchen Systems, LLC
800 Aviation Parkway
Smyrna, TN 37167
800-626-5771
franke.us

FRANKE