



SINGLE ZONE MEGA AND MEGA 115V WALL MOUNTED ENGINEERING MANUAL

3/4, 1, 1-1/2, and 2 Tons

Mega Models:

LS090HEV2 LS180HEV2
LS120HEV2 LS240HEV2



3/4 and 1 Tons

Mega 115V Models:

LS090HXV2 LS120HXV2



PROPRIETARY DATA NOTICE

**This document, as well as all reports, illustrations, data, information, and other materials are the property of LG Electronics U.S.A., Inc., and are disclosed by LG Electronics U.S.A., Inc. only in confidence.
This document is for design purposes only.**





A summary list of safety precautions is on page 3

For more technical materials such as submittals, catalogs, installation, owner's, and service manuals, visit www.lghvac.com.

TABLE OF CONTENTS

Unit Nomenclature	4
LG Air Conditioner Technical Solution (LATS)	5-6
Mega and Mega 115V Product Data	7-49
<i>Mechanical Specifications</i>	8
<i>General Data</i>	9-11
<i>Electrical Data</i>	12
<i>Functions, Controls, Options</i>	13
<i>Outdoor Unit Dimensions</i>	14-16
<i>Indoor Unit Dimensions</i>	17-18
<i>Acoustic Data</i>	19-24
<i>Refrigerant Flow Diagrams</i>	25-26
<i>Indoor Unit Wiring Diagrams</i>	27-28
<i>Outdoor Unit Wiring Diagrams</i>	29-31
<i>Electrical Connections</i>	32-35
<i>Air Flow, Static Pressure, and Temperature Distribution</i>	36-47
<i>Accessories</i>	48-49
Mega and Mega 115V Performance Data	50-60
<i>Cooling Capacity</i>	51-53
<i>Heating Capacity</i>	54-55
<i>Maximum Heating Capacity</i>	56-58
<i>Equipment Selection Procedure</i>	59-60
Mega and Mega 115V Application Guidelines	61-70
<i>Placement Considerations</i>	62-66
<i>Installing Outdoor Units Indoors</i>	67-69
<i>Refrigerant Piping Design</i>	70

TABLE OF SYMBOLS

 DANGER	<i>This symbol indicates an imminently hazardous situation which, if not avoided, will result in death or serious injury.</i>
 WARNING	<i>This symbol indicates a potentially hazardous situation which, if not avoided, could result in death or serious injury.</i>
 CAUTION	<i>This symbol indicates a potentially hazardous situation which, if not avoided, may result in minor or moderate injury.</i>
Note:	<i>This symbol indicates situations that may result in equipment or property damage accidents only.</i>
	<i>This symbol indicates an action that must not be performed.</i>

UNIT NOMENCLATURE

Single Zone Wall Mount Indoor and Outdoor Units

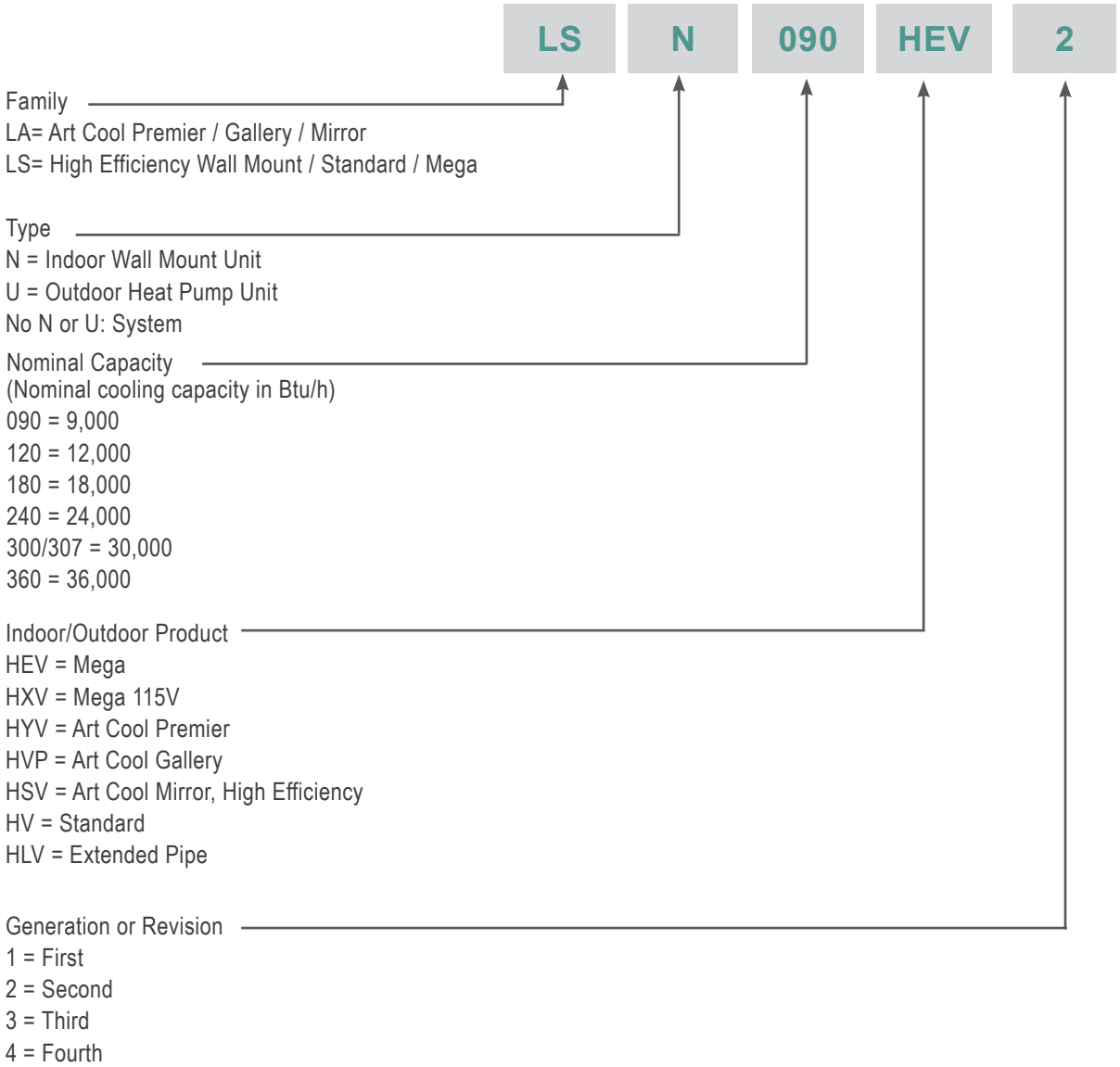

LG AIR CONDITIONER TECHNICAL SOLUTION (LATS)

LG Air Conditioner Technical Solution (LATS) Software

A properly designed and installed refrigerant piping system is critical to the optimal performance of LG air-conditioning systems. To assist engineers, LG offers, free of charge, LG Air Conditioner Technical Solution (LATS) software—a total design solution for LG air conditioning systems. Contact your LG Rep for the best software program for your application.

Note:

To reduce the risk of designing an improper applied system or one that will not operate correctly, LG requires that LATS software be used on all projects.

Formats

LATS is available to LG customers in three user interfaces: LATS HVAC, LATS CAD2, and LATS Revit. All three LATS formats are available through www.myLGHVAC.com, or contact an LG Sales Representative.

LATS HVAC is a Windows®-based application that aids engineers in designing LG Variable Refrigerant Flow (VRF), Multi F / Multi F MAX, Single-Zone, and Energy Recovery Ventilator (ERV) systems.

*Windows® is a registered mark of Microsoft® Corporation.

LATS CAD2 combines the LG LATS program with AutoCAD® software**. It permits engineers to layout and validate LG Multi V Variable Refrigerant Flow (VRF), Multi F / Multi F MAX, Single-Zone, and Energy Recovery Ventilator (ERV) systems directly into CAD drawings.

LATS Revit integrates the LG LATS program with Revit® software**. It permits engineers to layout and validate Multi V VRF systems directly into Revit drawings.

**AutoCAD® and Revit® are both registered marks of Autodesk, Inc.

Features

All LG product design criteria have been loaded into the program, making LATS simple to use: double click or drag and drop the component choices. Build systems in Tree Mode where the refrigerant system can be viewed. Switch to a Schematic diagram to see the electrical and communications wiring.

LATS software permits the user to input region data, indoor and outdoor design temperatures, modify humidity default values, zoning, specify type and size of outdoor units and indoor units, and input air flow and external static pressure (ESP) for ducted indoor units.

The program can also:

- Import building loads from a separate Excel file.
- Present options for outdoor unit auto selection.
- Automatically calculate component capacity based on design conditions for the chosen region.
- Verify if the height differences between the various system components are within system limits.
- Provide the correct size of each refrigerant piping segment and LG Y-Branches and Headers.
- Adjust overall piping system length when elbows are added.
- Check for component piping limitations and flag if any parameters are broken.
- Factor operation and capacity for defrost operation.
- Calculate refrigerant charge, noting any additional trim charge.
- Suggest accessories for indoor units and outdoor units.
- Run system simulation.

Note:

Features depend on which LATS program is being used, and the type of system being designed.

Figure 1: Example of LATS CAD2.

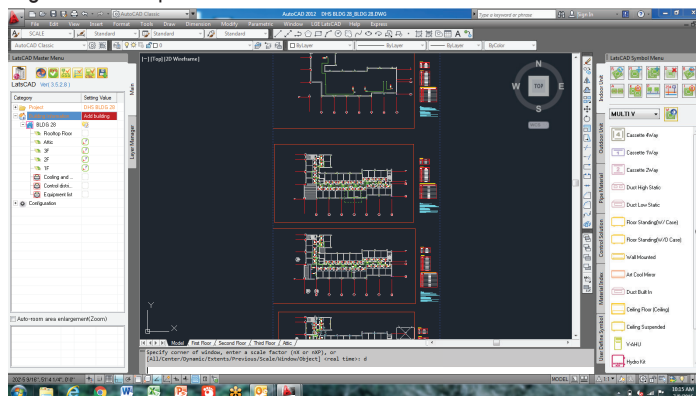

LG AIR CONDITIONER TECHNICAL SOLUTION (LATS)

LATS Generates a Complete Project Report

LATS software also generates a report containing project design parameters, cooling and heating design data, system component performance, and capacity data. The report includes system combination ratio and refrigerant charge calculations; and provides detailed bill of material, including outdoor units, indoor units, control devices, accessories, refrigerant pipe sizes segregated by building, by system, by pipe size, and by pipe segments. LATS can generate an Excel GERP report that can imported into the LG SOPS pricing and ordering system.

Proper Design to Install Procedure

LG encourages a two report design-to-install-procedure. After the design engineer determines building / zone loads and other details, the engineer opens the LATS program and inputs the project's information. When the design is complete, the "Auto Piping" and "System Check" functions must be used to verify piping sizes, limitations, and if any design errors are present. If errors are found, engineers must adjust the design, and run Auto Piping and System Check again. When the design passes the checks, then the engineer prints out a project "Shop Drawing" (LATS Tree Diagram) and provides it to the installing contractor. The contractor must follow the LATS Tree Diagram when building the piping system, but oftentimes the design changes on the building site:

- Architect has changed location and/or purpose of room(s).
- Outdoor unit cannot be placed where originally intended.
- Structural elements prevent routing the piping as planned.
- Air conditioning system conflicts with other building systems (plumbing, gas lines, etc.).

The contractor must mark any deviation from the design on the Shop Drawing, including as-built straight lines and elbows. This "Mark Up" drawing must be returned to the design engineer or Rep, who must input contractor changes into the LATS file. (Copy the original LATS software file, save and rename as a separate file, and modify all piping lengths by double-clicking on each length and editing information.) Like the shop drawing, the Auto Piping and System Check must also be run on this new "As Built" drawing. The design engineer or Rep must then provide the final As Built file to the contractor. The Mark Up version must be compared to the As Built version for:

- Differences in pipe diameter(s). If incorrect diameters have been installed, the piping must be changed out. If pipe diameters have changed, check to see if Y-Branches will also need to be changed.
- Changes to outdoor unit and indoor unit capacities. Capacities changes will impact line length changes.
- Additional refrigerant charge quantity ("Trim Charge"). Trim charge will change if piping lengths and diameters change. The As Built version must reflect installed piping lengths to ensure correct trim charge.

All documents submitted by the contractor, as well as the Shop Drawing and the As Built Drawing files must be provided for commissioning purposes. Model and serial numbers for all system components must also be submitted. If the steps previously detailed are not followed, and all documents are not provided to the commissioning agent, the project runs the risk of not being commissioned and voiding any limited warranty LG offers on the equipment.

Note:

Contact your LG representative for the best software program for your application.

Figure 2: Example of a LATS Tree Diagram.

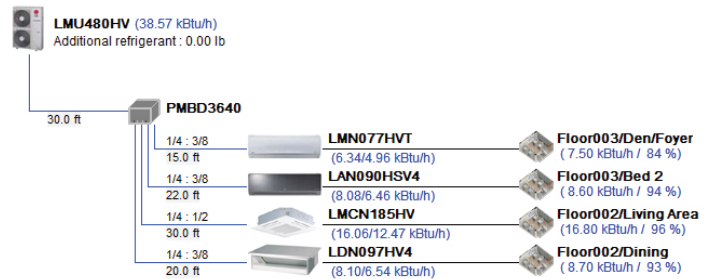

PRODUCT DATA

Mechanical Specifications on page 8

General Data on page 9

Electrical Data on page 12

Functions, Controls, Options on page 13

Outdoor Unit Dimensions on page 14

Indoor Unit Dimensions on page 17

Acoustic Data on page 19

Refrigerant Flow Diagrams on page 25

Indoor Unit Wiring Diagrams on page 27

Outdoor Unit Wiring Diagrams on page 29

Electrical Connections on page 32

**Air Flow, Static Pressure, and Temperature Distribution
on page 36**

Accessories on page 48

MECHANICAL SPECIFICATIONS

Single Zone Mega and Mega 115V

General

LG Single Zone Mega Wall Mounted systems comprise of a single outdoor unit connected to a single indoor unit with a single refrigerant circuit.

An LG Single Zone Mega Wall Mounted system is a Duct-Free Split system that can operate in either cooling or heating mode. The system shall be capable of changing mode within a maximum time of three (3) minutes to ensure indoor temperature can be properly maintained.

LG Single Zone Mega systems are manufactured in a facility registered to ISO 9001 and ISO 14001, which is a set of standards applying to environmental protection set by the International Organization for Standardization (ISO). Wiring in these units are in accordance with the National Electrical Code (NEC).

Temperature Ranges

Mega (HEV2)

Operating ranges for outdoor unit of 14°F to 118°F (DB) for cooling; 14°F to 65°F (WB) for heating.

Operating ranges for indoor unit of 53°F to 75°F (WB) for cooling; 60°F to 86°F (DB) for heating.

Mega 115V (HXV2)

Operating ranges for outdoor unit of 14°F to 118°F (DB) for cooling; 14°F to 65°F (WB) for heating.

Operating ranges for indoor unit of 53°F to 75°F (WB) for cooling; 60°F to 86°F (DB) for heating.

Casing / Frame

Outdoor unit is constructed with pre-coated metal (PCM).

Indoor unit is constructed of heavy duty Acrylonitrile Butadiene Styrene (ABS) and High Impact Polystyrene (HIPS) plastic.

Refrigerant System

The refrigeration system consists of a single refrigeration circuit and uses R410A refrigerant. The outdoor unit is provided with factory installed components, including a refrigerant strainer, check valves, oil separator, accumulator, four-way reversing valve, EEV, high

and low side charging ports, service valves, and interconnecting piping.

Refrigeration Oil Control

Heat Pump outdoor units have a centrifugal oil separator and controls to ensure sufficient oil supply is maintained, and that oil does not travel with the refrigerant.

Compressors

The outdoor unit is equipped with one hermetic, digitally controlled, inverter driven, twin-rotary compressor to modulate capacity (modulation in 1 Hz increments).

Frequency ranges for the (HEV2) outdoor units are:

9k Btu/h = 10 to 92 Hz

12k Btu/h = 10 to 98 Hz

18 Btu/h = 10 to 87 Hz

24k Btu/h = 10 to 95 Hz

Frequency ranges for the (HXV2) outdoor units are:

9k Btu/h = 10 to 74 Hz (cooling); 10 to 98 Hz (heating)

12k Btu/h = 10 to 74 Hz (cooling); 10 to 98 Hz (heating)

Over-current protection and vibration isolation are integrated with the compressor.

Outdoor Unit Coil

Heat Pump outdoor unit coils are of a nonferrous construction with louvered fins on copper tubing, and are protected with an integral coil guard. Coil fins have a factory applied corrosion resistant GoldFin™ material with hydrophilic coating.

Fans and Motors

The outdoor unit includes one direct drive, variable speed propeller type fan.

The Brushless Digitally Controlled (BLDC) fan motor has inherent protection, permanently lubricated bearings, and variable speed with a maximum speed up to 950 rpm. Raised guards are provided to limit contact with moving parts.

The outdoor unit has horizontal discharge airflow.



Electrical

The HEV2 model unit is available in a 208-230V 60 Hz, 1-phase power supply. The HXV2 model unit is available in a 115V 60 Hz, 1-phase power supply. The units are capable of operating within voltage limits of ±10% rated voltage, and include overcurrent protection.

Controls

The unit is factory wired with necessary electrical control components, integral microprocessors, printed circuit boards, thermistors, sensors, terminal blocks, and lugs for power wiring.









Microprocessor-based algorithms provide component protection, soft-start capability, refrigeration system pressure, temperature, defrost, and ambient control.

GENERAL DATA

Mega Pairing Table

The following table shows the available outdoor and indoor unit, along with the factory provided controller.

Table 1: Single Zone Mega and Mega 115V Pairing Table

Outdoor Unit Model	Indoor Unit Model	Controller
<i>Mega Inverter</i>		
LSU090HEV2 LSU120HEV2 	LSN090HEV2 LSN120HEV2 	AKB74955602 
LSU180HEV2 LSU240HEV2 	LSN180HEV2 LSN240HEV2 	AKB74955602 
<i>Mega 115V</i>		
LSU090HXV2 LSU120HXV2 	LSN090HXV2 LSN120HXV2 	AKB74955602 

Product Data

GENERAL DATA

Mega Specifications

Table 2: Single Zone Mega System Specifications.

System Model Number (IDU/ODU)	LS090HEV2 (LSN090HEV2/ LSU090HEV2)	LS120HEV2 (LSN120HEV2/ LSU120HEV2)	LS180HEV2 (LSN180HEV2/ LSU180HEV2)	LS240HEV2 (LSN240HEV2/ LSU240HEV2)
Cooling Capacity (Min/Rated/Max) (Btu/h)	3,070 ~ 9,000 ~ 10,330	3,070 ~ 12,000 ~ 13,780	3,685 ~ 18,000 ~ 18,493	3,685 ~ 22,000 ~ 24,000
Cooling Power Input ¹ (kW)	0.72	1.142	1.5	2.0
Heating Capacity (Min/Rated/Max) (Btu/h)	3,070 ~ 10,900 ~ 12,520	3,070 ~ 12,000 ~ 13,780	3,685 ~ 19,000 ~ 22,997	3,685 ~ 22,000 ~ 25,260
Heating Power Input ¹ (kW)	0.875	1.000	1.583	1.93
COP	12.46	12.00	12.00	11.40
Max. Heating Capacity (Btu/h) Outdoor 17°F (WB)/Indoor 70°F (DB)	8,760 (80%)	9,640 (80%)	15,270 (80%)	17,680 (80%)
EER	12.5	10.51	12.00	11.00
SEER	20.0	19.0	19.0	19.0
HSPF	10.0	9.5	10.0	9.5
Power Supply (V/Hz/Ø)	208-230/60/1			
<i>Outdoor Unit Operating Range</i>				
Cooling (°F DB)	14 to 118			
Heating (°F WB)	14 to 65			
<i>Indoor Unit Operating Range</i>				
Cooling (°F WB)	53 to 75			
Heating (°F DB)	60 to 86			
<i>Indoor Temperature Setting Range</i>				
Cooling (°F)	64 to 86			
Heating (°F)	60 to 86			
<i>Unit Data</i>				
Refrigerant Type ²	R410A			
Refrigerant Control	EEV			
IDU Sound Pressure ³ dB(A) (H/M/L/Sleep)	42 / 36 / 28 / 21	42 / 36 / 28 / 21	48 / 43 / 38 / 32	48 / 43 / 38 / 32
ODU Sound Pressure ³ dB(A)	50	50	55	55
<i>Unit Weight (lbs)</i>				
IDU (Net / Shipping)	19.2 / 25.4	19.2 / 25.4	26 / 30	26 / 30
ODU (Net / Shipping)	55.3 / 60	55.3 / 60	98.1 / 108	98.1 / 108
Power/Communication Cable ⁴ (No. x AWG)	4 x 14			
<i>Compressor</i>				
Compressor Type (Qty)	Twin Rotary (1)			
<i>Fan</i>				
Indoor Unit Type (Qty)	Cross Flow (1)			
Outdoor Unit Type (Qty)	Propeller (1)			
Motor/Drive	Brushless Digital Controlled/Direct			
<i>Airflow Rate</i>				
Indoor Unit Max/H/M/L (CFM)	459 / 353 / 264 / 148	459 / 353 / 264 / 148	689 / 512 / 459 / 371	689 / 512 / 459 / 371
Outdoor Unit (Max. [CFM])	953	953	1,730	1,730
<i>Piping</i>				
Liquid Line (in, OD)	1/4	1/4	1/4	1/4
Vapor Line (in, OD)	3/8	3/8	1/2	1/2
Condensation Line (OD, ID)	27/32, 5/8	27/32, 5/8	27/32, 5/8	27/32, 5/8
Additional Refrigerant Charge (oz/ft)	0.22	0.22	0.26	0.26
Pipe Length ⁵ (Minimum/Maximum)(ft)	9.8 / 49.2	9.8 / 49.2	9.8 / 65.6	9.8 / 65.6
Piping Length ⁵ (no add'l refrigerant, ft)	24.6	24.6	24.6	24.6
Max Elevation Difference (ft)	23	23	32.8	32.8

EEV: Electronic Expansion Valve IDU: Indoor Unit ODU: Outdoor Unit

This unit comes with a dry helium charge.

This data is rated 0 ft above sea level with 24.6 of refrigerant line per indoor unit and a 0 ft level difference outdoor and indoor units.

Cooling capacity rating obtained with air entering the indoor unit at 80°F dry bulb (DB) and 67°F wet bulb (WB) and outdoor ambient conditions of 95°F dry bulb (DB) and 75°F wet bulb (WB). Heating capacity rating obtained with air entering the indoor unit at 70°F dry bulb (DB) and 59°F wet bulb (WB) and outdoor ambient conditions of 47°F dry bulb (DB) and 43°F wet bulb (WB).

¹Power Input is rated at high speed.

²Take appropriate actions at the end of HVAC equipment life to recover, recycle, reclaim or destroy R410A refrigerant according to applicable regulations (40 CFR Part 82, Subpart F) under section 608 of CAA.

³Sound Pressure levels are tested in an anechoic chamber under ISO Standard 3745.

⁴All communication / connection (power) cable from the outdoor unit to the indoor unit is field supplied and must be a minimum of four-conductor, 14 AWG, stranded, shielded or unshielded (if shielded, it must be grounded to the chassis of the outdoor unit only), and must comply with applicable local and national codes. For detailed electrical information, please refer to electric characteristics on page 12.

⁵Piping lengths are equivalent.

GENERAL DATA

Mega 115V Specifications

Table 3: Single Zone Mega 115V System Specifications.

System Model Number (IDU/ODU)	LS090HXV2 (LSN090HXV2/LSU090HXV2)	LS120HXV2 (LSN120HXV2/LSU120HXV2)
Cooling Capacity (Min/Rated/Max) (Btu/h)	3,070 ~ 9,000 ~ 10,330	3,070 ~ 12,000 ~ 13,780
Cooling Power Input ¹ (kW)	0.732	1.142
Heating Capacity (Min/Rated/Max) (Btu/h)	3,070 ~ 10,900 ~ 12,520	3,070 ~ 12,000 ~ 13,780
Heating Power Input ¹ (kW)	0.875	1.000
COP	3.65	3.52
EER	12.30	10.51
SEER	20	19
HSPF	10	9.5
Power Supply (V/Hz/Ø)	115/60/1	
<i>Outdoor Unit Operating Range</i>		
Cooling (°F DB)	14 to 118	
Heating (°F WB)	14 to 65	
<i>Indoor Unit Operating Range</i>		
Cooling (°F WB)	53 to 75	
Heating (°F DB)	60 to 86	
<i>Indoor Temperature Setting Range</i>		
Cooling (°F)	65 to 86	
Heating (°F)	60 to 86	
<i>Unit Data</i>		
Refrigerant Type ²	R410A	
Refrigerant Control	EEV	
IDU Sound Pressure ³ dB(A) (H/M/L/Sleep)	42 / 36 / 28 / 21	42 / 36 / 28 / 21
ODU Sound Pressure ³ dB(A)	50	50
<i>Unit Weight (lbs)</i>		
IDU (Net/Shipping)	19.2 / 22	19.2 / 22
ODU (Net/Shipping)	58.4 / 60	58.4 / 60
Power/Communication Cable ⁴ (No. x AWG)	4 x 14	
<i>Compressor</i>		
Compressor Type (Qty)	Twin Rotary (1)	Twin Rotary (1)
<i>Fan</i>		
IDU Type (Qty)	Cross Flow (1)	
ODU Type (Qty)	Propeller (1)	
Motor/Drive	Brushless Digitally Controlled/Direct	
<i>Airflow Rate</i>		
IDU Max/H/M/L (CFM)	459 / 353 / 264 / 148	459 / 353 / 264 / 148
ODU Max (CFM)	953	953
<i>Piping</i>		
Liquid Line (in, OD)	1/4	1/4
Vapor Line (in, OD)	3/8	3/8
Condensation Line (OD, ID)	27/32, 5/8	27/32, 5/8
Additional Refrigerant Charge (oz/ft)	0.22	0.22
Pipe Length ⁵ (Minimum/Maximum)(ft)	9.8 / 49.2	9.8 / 49.2
Piping Length ⁵ (no add'l refrigerant, ft)	24.6	24.6
Max Elevation Difference (ft)	23	23

EEV: Electronic Expansion Valve IDU: Indoor Unit ODU: Outdoor Unit

This unit comes with a dry helium charge.

This data is rated 0 ft above sea level with 24.6 of refrigerant line per indoor unit and a 0 ft level difference outdoor and indoor units.

Cooling capacity rating obtained with air entering the indoor unit at 80°F dry bulb (DB) and 67°F wet bulb (WB) and outdoor ambient conditions of 95°F dry bulb (DB) and 75°F wet bulb (WB).

Heating capacity rating obtained with air entering the indoor unit at 70°F dry bulb (DB) and 59°F wet bulb (WB) and outdoor ambient conditions of 47°F dry bulb (DB) and 43°F wet bulb (WB).

¹Power Input is rated at high speed.

²Take appropriate actions at the end of HVAC equipment life to recover, recycle, reclaim or destroy R410A refrigerant according to applicable regulations (40 CFR Part 82, Subpart F) under section 608 of CAA.

³Sound Pressure levels are tested in an anechoic chamber under ISO Standard 3745.

⁴All communication / connection (power) cable from the outdoor unit to the indoor unit is field supplied and must be a minimum of four-conductor, 14 AWG, stranded, shielded or unshielded (if shielded, it must be grounded to the chassis of the outdoor unit only), and must comply with applicable local and national codes. For detailed electrical information, please refer to electric characteristics on page 12.

⁵Piping lengths are equivalent.

ELECTRICAL DATA

Mega and Mega 115V Outdoor Units

Electrical Data

Table 4: 208-230V, 60Hz, 1-Phase Single-Zone Mega System Electrical Data Table.

Nominal Tons	Unit Model No.	Hertz	Voltage	Voltage Range (Min. to Max.)	MCA	MOP	Compressor Quantity	Compressor Motor RLA		Outdoor Fan Motor		Indoor Fan Motor	
								Cooling	Heating	W	FLA	W	FLA
3/4	LS090HEV2	60	208 - 230	187-253	10.0	15	1	7.0	7.0	43	0.4	30	0.4
1	LS120HEV2				10.0	15	1	7.0	7.0	43	0.4	30	0.4
1-1/2	LS180HEV2				15.0	20	1	10.0	10.0	85	0.4	58	0.4
2	LS240HEV2				15.0	20	1	10.0	10.0	85	0.4	58	0.4

Voltage tolerance is ±10%.

Maximum allowable voltage unbalance is 2%.

MCA = Minimum Circuit Ampacity.

Maximum Overcurrent Protection (MOP) is calculated as follows: (Largest motor FLA x 2.25) + (Sum of other motor FLA) rounded down to the nearest standard fuse size.

RLA = Rated Load Amps.

FLA = Full Load Amps.

Table 5: 115V, 60Hz, 1-Phase Single Zone Single-Zone Mega 115V System Electrical Data Table.

Nominal Tons	Unit Model No.	Hertz	Voltage	Voltage Range (Min. to Max.)	MCA	MOP	Compressor Quantity	Compressor Motor RLA		Outdoor Fan Motor		Indoor Fan Motor	
								Cooling	Heating	W	FLA	W	FLA
3/4	LS090HXV2	60	115	98-132	15	25	1	11.0	11.0	43	0.4	30	0.4
1	LS120HXV2				15	25	1	11.0	11.0	43	0.4	30	0.4

Voltage tolerance is ±10%.

Maximum allowable voltage unbalance is 2%.

MCA = Minimum Circuit Ampacity.

Maximum Overcurrent Protection (MOP) is calculated as follows: (Largest motor FLA x 2.25) + (Sum of other motor FLA) rounded down to the nearest standard fuse size.

RLA = Rated Load Amps.

FLA = Full Load Amps.

FUNCTIONS, CONTROLS, OPTIONS

Table 6: Indoor Units—Functions, Controls and Options.

Indoor Unit Type		LS090-120-180-240HEV2 ¹	LS090-120HXV2
Airflow	Air Supply Outlet	1	1
	Airflow Direction Control (Left / Right)	Manual	Manual
	Airflow Direction Control (Up / Down)	Auto	Auto
	Auto Swing (Up / Down)	√	√
	Fan Speed Airflow Steps (Fan / Cool / Heat)	6 / 6 / 6	6 / 6 / 6
	Natural Wind (Auto Wind)	√	√
	Jet Cool / Jet Heat (Power Wind)	√ / √	√ / √
	Comfort Air	√	√
Air Purifying	Prefilter (Washable Anti-Bacterial / Anti-Fungal ²)	√	√
Functions	Hot Start	√	√
	Self Diagnostics	√	√
	Defrost	√	√
	Dry (Dehumidification)	√	√
	Auto Changeover	√	√
	Auto Cleaning (Coil Dry)	√	√
	Auto Restart	√	√
	Forced Operation	√	√
	Sleep Mode	√ / 7 hour	√
	Timer 24 hour (On / Off) / 7 hour (Off)	√ / X	√
	Timer (Weekly)	X	X
	Two Thermistor Control	X	X
	Low Ambient	√	√
	Overheat Protection	√	√
	Smart Diagnosis	√	X
	Indoor Unit Display Type	Number Display	Number Display
	Indoor Unit Display Light	On / Off	On / Off
Energy Saving	√	√	
Electric Heater	X	X	
Controllers	Wireless Remote Controller	AKB74955602	AKB74955602
	Remote Controller MultiSITE™ CRC1	PREMTBVC0	PREMTBVC0
	Remote Controller MultiSITE CRC1+	PREMTBVC1	PREMTBVC1
	Dry Contact	X	PDRYCB100, PDRYCB320, PDRYCB400
	Central control (LGAP)	X	X
Special Function Kit	PI 485	X	X
	Zone control	X	X
	CTIE	X	X
	Electro thermostat	X	X
	Wi-Fi Module (Option)	X	X
	Water level sensor connection (for optional AG-9300-LG)	o	o
	Wind baffle kit	X	X
Other	Mode Lock	Cooling Only or Heating Only	Cooling Only or Heating Only
	Temperature Control	Thermistor	Thermistor
	Smart Inverter Monitoring System (SIMS)	√	√

¹LSN***HEV2 9,000 and 12,000 Btu/h Mega indoor units are compatible with wired controllers from July 2019 production; LSN***HEV2 18,000 and 24,000 Btu/h Mega indoor units are compatible with wired controllers from January 22, 2020 production.

²Primary washable filters.

√ = Standard feature
o = Optional accessory (must be purchased separately)
X = Not available

OUTDOOR UNIT DIMENSIONS

LSU090HEV2, LSU120HEV2, LSU090HXV2, LSU120HXV2

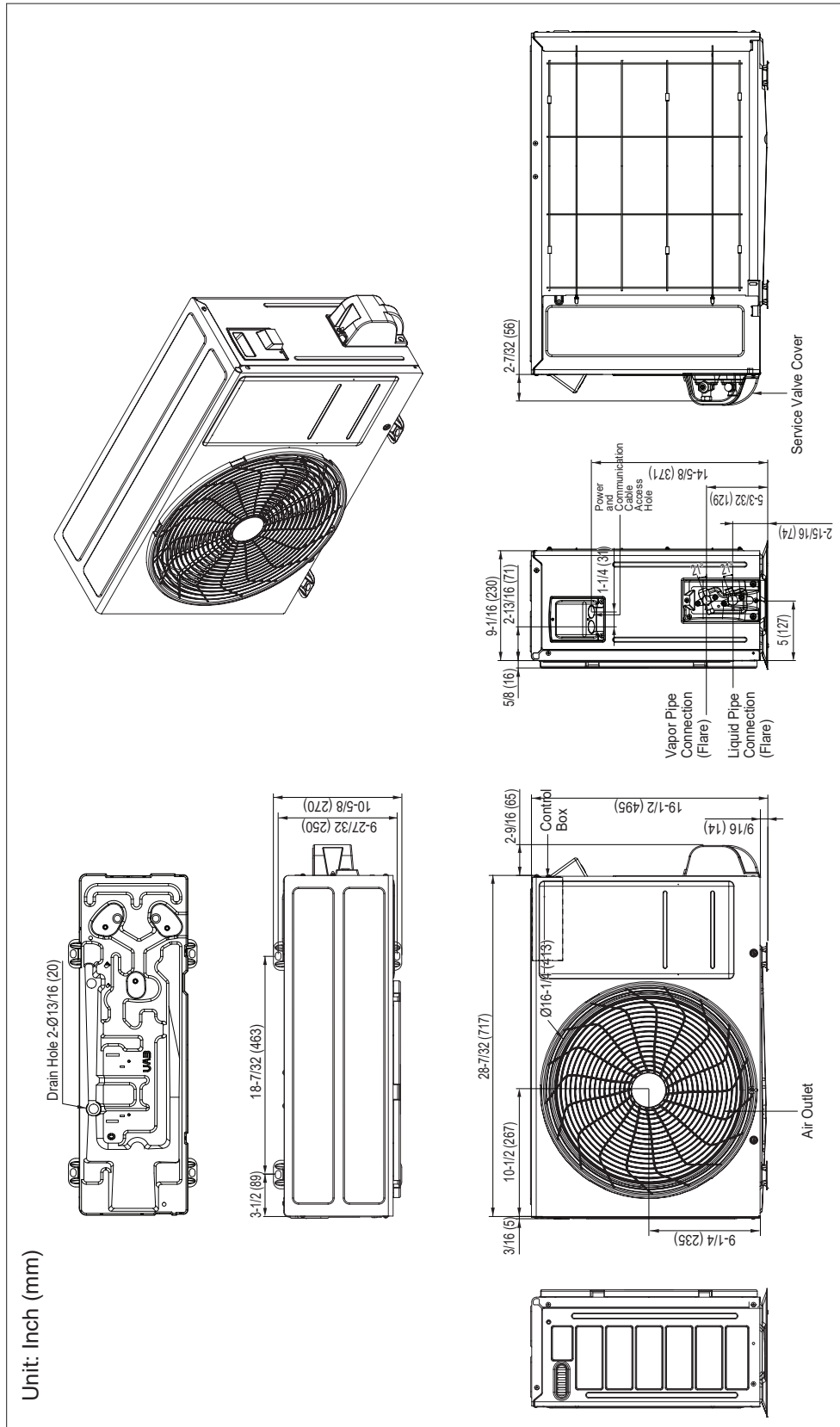

OUTDOOR UNIT DIMENSIONS

LSU180HEV2, LSU240HEV2

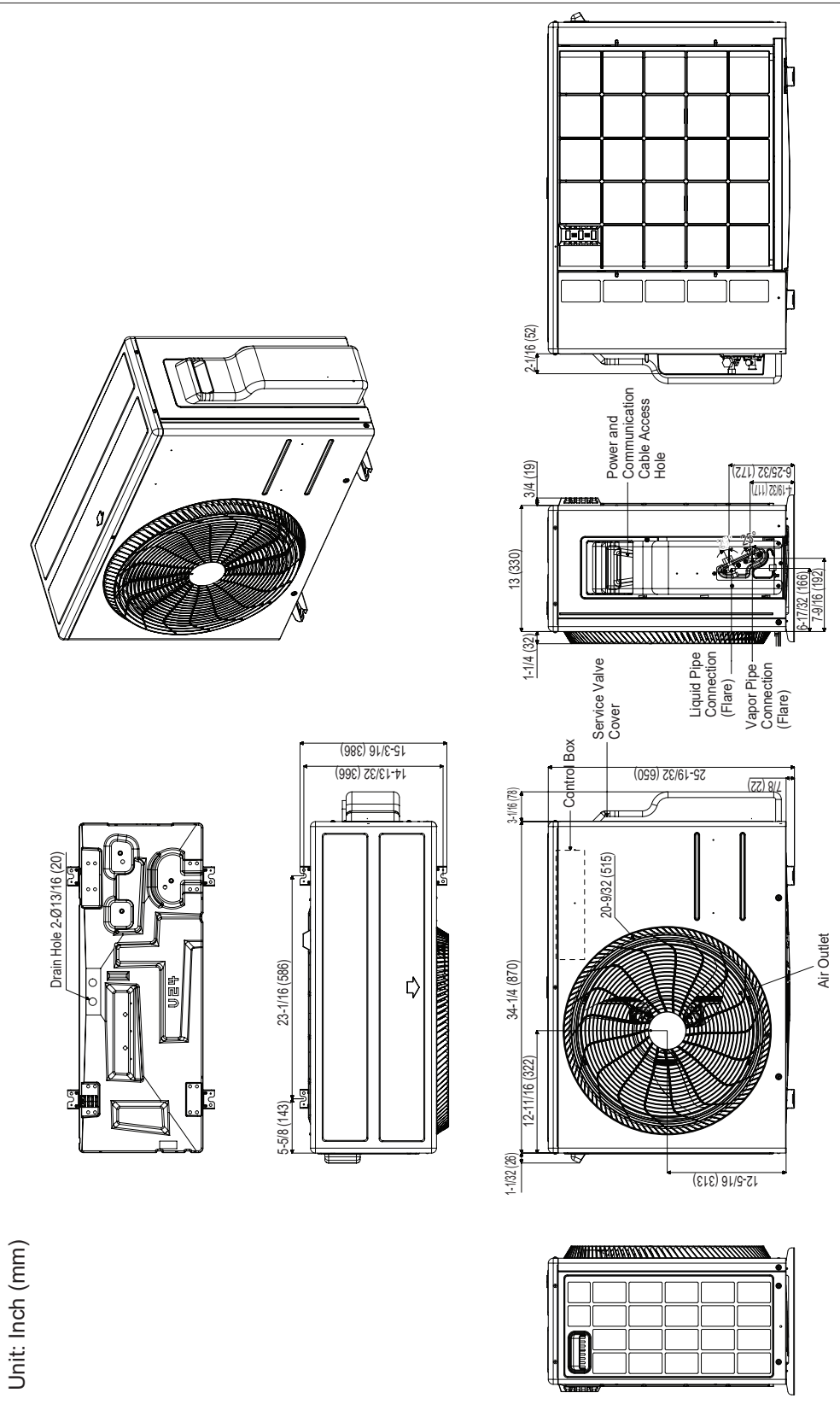

Product Data

OUTDOOR UNIT CORNER WEIGHT AND CENTER OF GRAVITY DIMENSIONS

Figure 3: Mega and Mega 115V Outdoor Unit Corner Weight and Center of Gravity Dimensions.

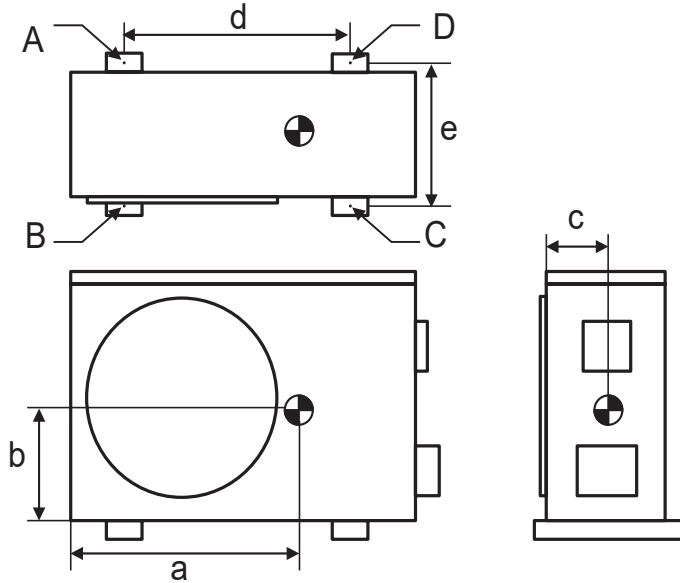

Table 7: Mega and Mega 115V Outdoor Unit Corner Weight and Center of Gravity Dimensions.

Model No.	Weight (lb.)		Center of Gravity (Inch)			Leg (Inch)		Corner Weight (lb.)			
	Shipping	Net	a	b	c	d	e	A	B	C	D
<i>Mega</i>											
LSU090HEV2, LSU120HEV2	60.0	55.3	18-11/16	8-5/8	4-7/16	18-7/32	10-3/32	3.5	5.7	23.1	23.0
LSU180HEV2, LSU240HEV2	108.0	98.1	22-1/4	10-1/4	5-29/32	23-1/16	14-13/32	11.4	16.0	37.3	33.4
<i>Mega 115V</i>											
LSU090HXV2, LSU120HXV2	60.0	58.4	18-11/16	8-5/8	4-7/16	18-7/32	10-3/32	4.2	5.5	24.9	23.8

ACOUSTIC DATA

Mega and Mega 115V Indoor Units

Indoor Unit Sound Pressure Measurement / Sound Pressure Levels

Figure 4: Mega Indoor Unit Sound Level Measurement.

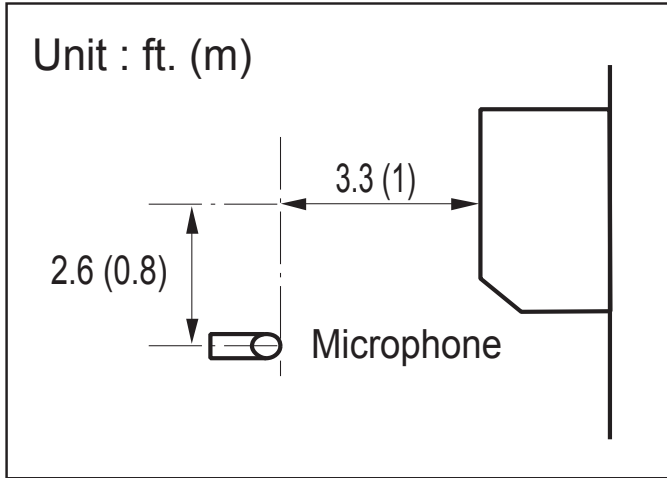

- Measurements are taken 3.3 ft away from the front of the unit.
- Sound pressure levels are measured in dB(A) with a tolerance of ± 1 .
- Data is valid at nominal operation conditions. Operating conditions are assumed to be standard.
- Reference acoustic pressure $0\text{dB}=20\mu\text{Pa}$
- Sound pressure levels are tested in an anechoic chamber under ISO Standard 3745, and may be different according to the test condition or equipment.
- Sound level will vary depending on a range of factors including the construction (acoustic absorption coefficient) of a particular room in which the unit was installed.

Table 8: Indoor Unit Acoustic Data.

Model	Sound Pressure Levels (dB[A])					
	Cooling			Heating		
	H	M	L	H	M	L
<i>Mega</i>						
LSN090HEV2	42	36	28	42	36	28
LSN120HEV2	42	36	28	42	36	28
LSN180HEV2	48	43	38	48	43	38
LSN240HEV2	48	43	38	48	43	38
<i>Mega 115V</i>						
LSN090HXV2	42	36	28	42	36	28
LSN120HXV2	42	36	28	42	36	28

Product Data

LSN090HEV2 Sound Pressure Levels

Figure 5: Sound Pressure Levels for Mega LSN090HEV2 Indoor Units.

LSN090HEV2

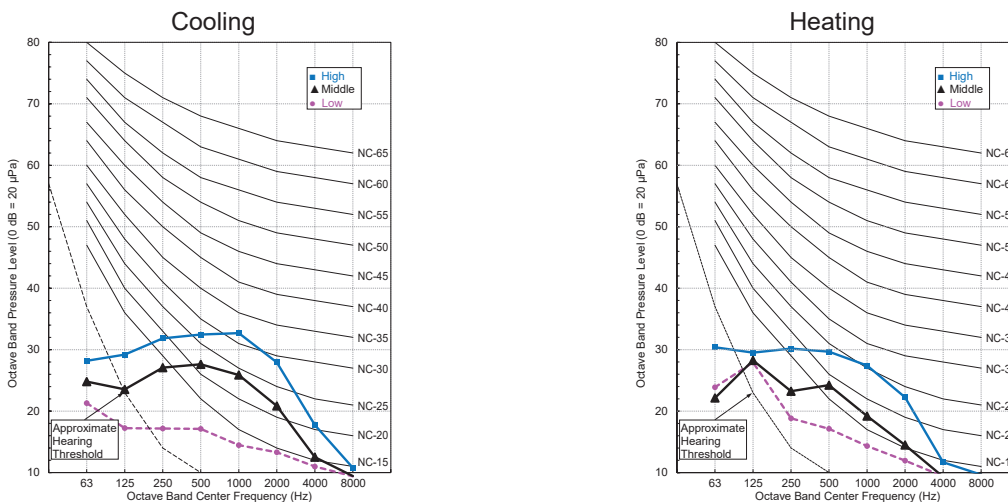

ACOUSTIC DATA

Mega and Mega 115V Indoor Units

LSN120HEV2, LSN180HEV2, and LSN240HEV2 Sound Pressure Levels

Figure 6: Sound Pressure Levels for Mega LSN120HEV2 Indoor Units.

LSN120HEV2

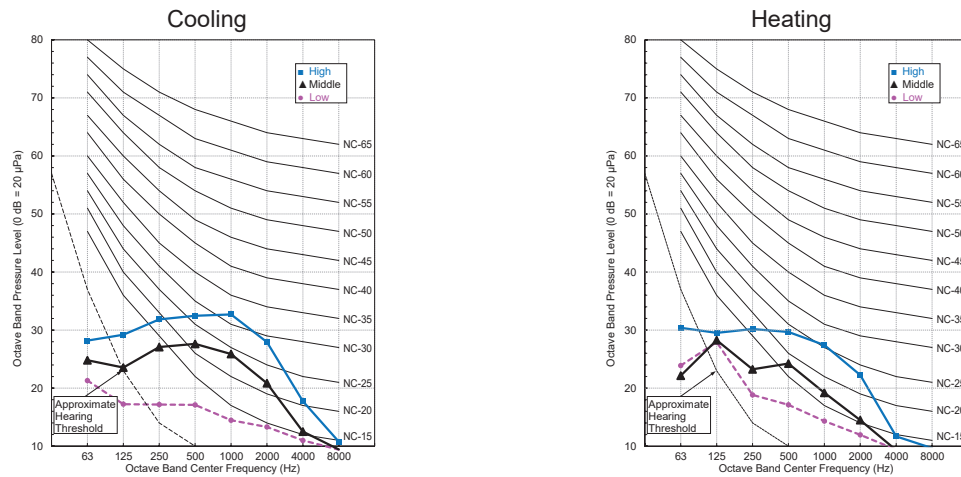

Figure 7: Sound Pressure Levels for Mega LSN180HEV2 Indoor Units.

LSN180HEV2

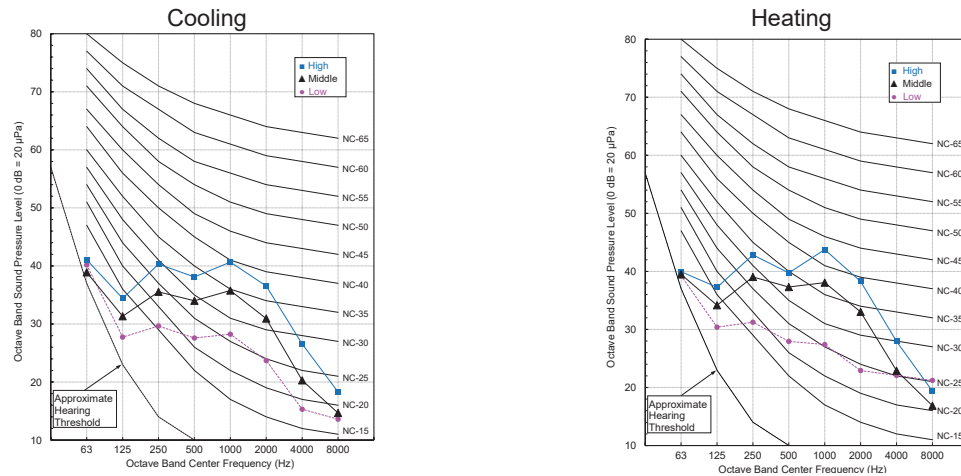
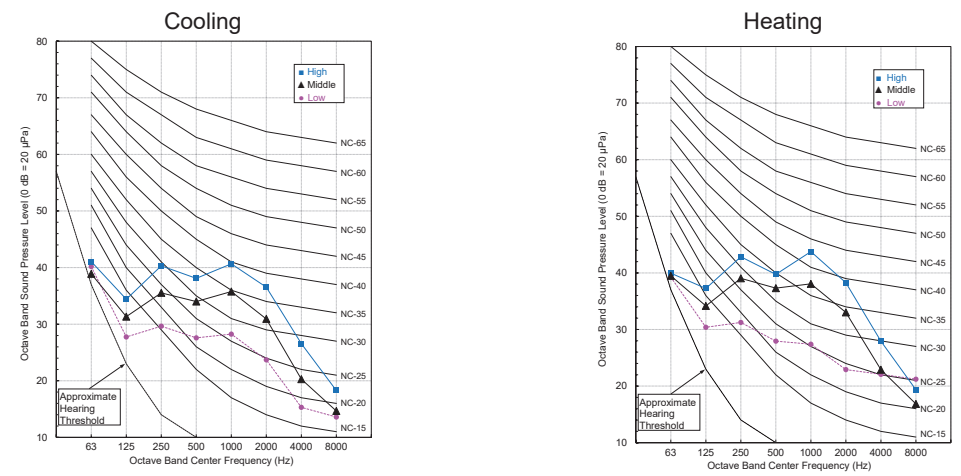

Figure 8: Sound Pressure Levels for Mega LSN240HEV2 Indoor Units.

LSN240HEV2



LSN090HXV2 and LSN120HXV2 Sound Pressure Levels

Figure 9: Sound Pressure Levels for Mega 115V LSN090HXV2 Indoor Units.

LSN090HXV2

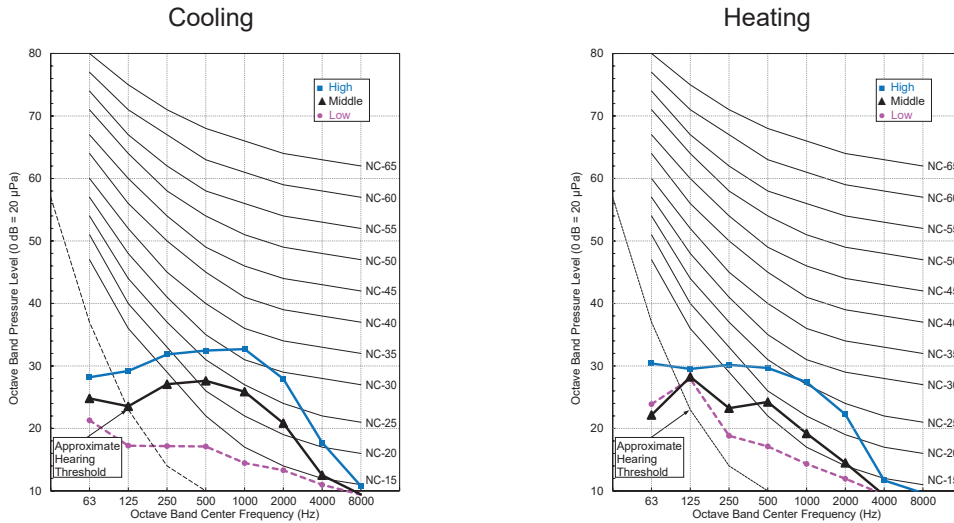
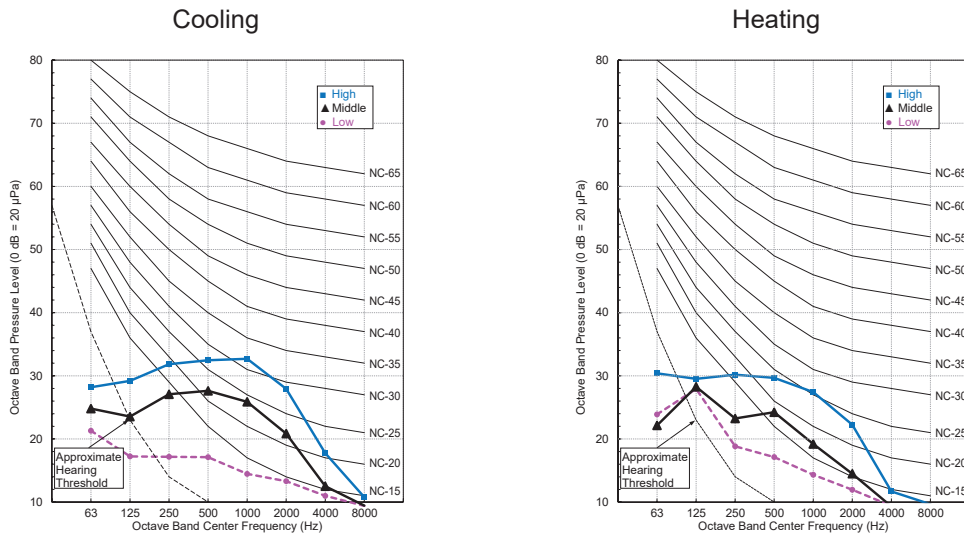

Figure 10: Sound Pressure Levels for Mega 115V LSN120HXV2 Indoor Units.

LSN120HXV2



ACOUSTIC DATA

Mega and Mega 115V Outdoor Units

Outdoor Unit Sound Pressure Measurement / Sound Pressure Levels

Figure 11: Outdoor Unit Sound Levels

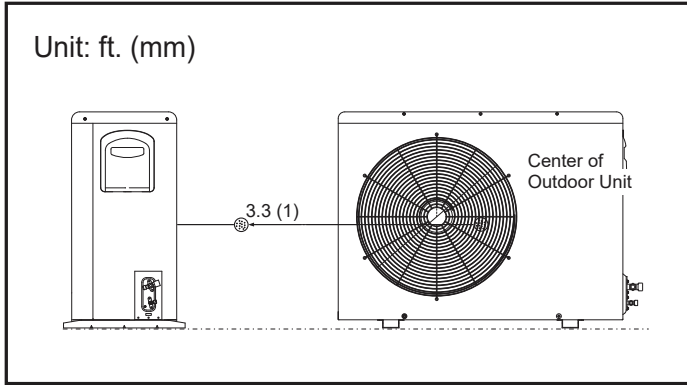

Diagram above for illustrative purposes only. Actual appearance differs depending on outdoor unit model.

- Measurements are taken 3.3 ft away from the front of the unit.
- Sound pressure levels are measured in dB(A) with a tolerance of ± 1 .
- Data is valid at nominal operation conditions. Operating conditions are assumed to be standard.
- Reference acoustic pressure $0\text{dB}=20\mu\text{Pa}$
- Sound pressure levels are tested in an anechoic chamber under ISO Standard 3745, and may be different according to the test condition or equipment.
- Sound level will vary depending on a range of factors including the construction (acoustic absorption coefficient) of a particular room in which the unit was installed.

Table 9: Outdoor Unit Acoustic Data

Model	Sound Pressure Levels (dB(A))	
	Cooling (High)	Heating (High.)
<i>Mega</i>		
LSU090HEV2	50	50
LSU120HEV2	50	50
LSU180HEV2	55	55
LSU240HEV2	55	55
<i>Mega 115V</i>		
LSU090HXV2	50	50
LSU120HXV2	50	50

LSU090HEV2 Sound Pressure Levels

Figure 12: Sound Pressure Levels for Mega LSU090HEV2 Outdoor Units.

LSU090HEV2

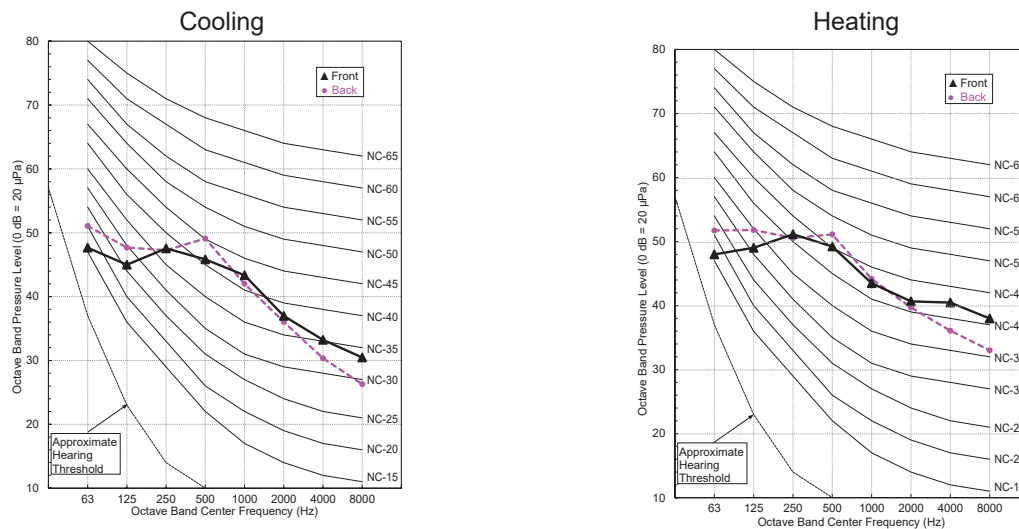

LSU120HEV2, LSU180HEV2, and LSU240HEV2 Sound Pressure Levels

Figure 13: Sound Pressure Levels for Mega LSU120HEV2 Outdoor Units.

LSU120HEV2

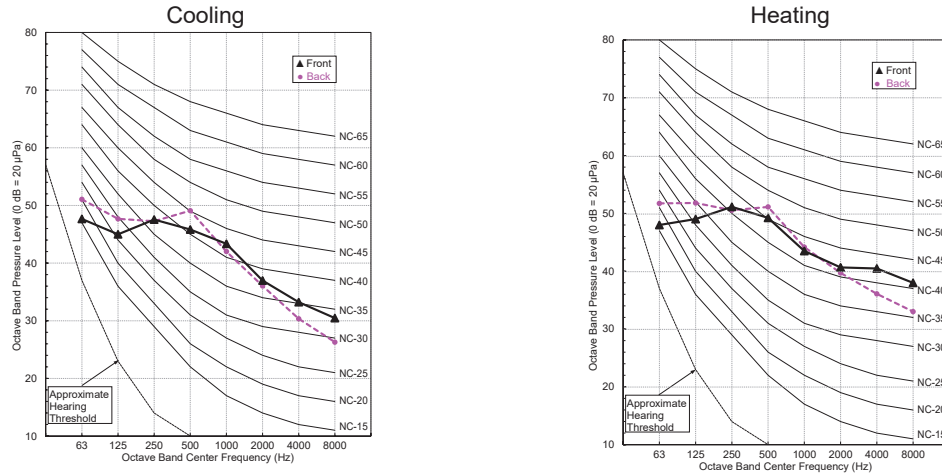

Figure 14: Sound Pressure Levels for Mega LSU180HEV2 Outdoor Units.

LSU180HEV2

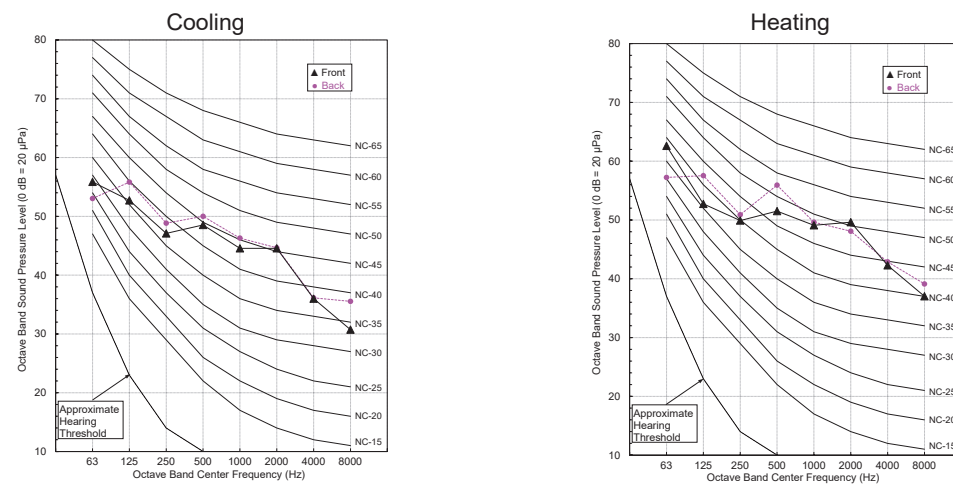
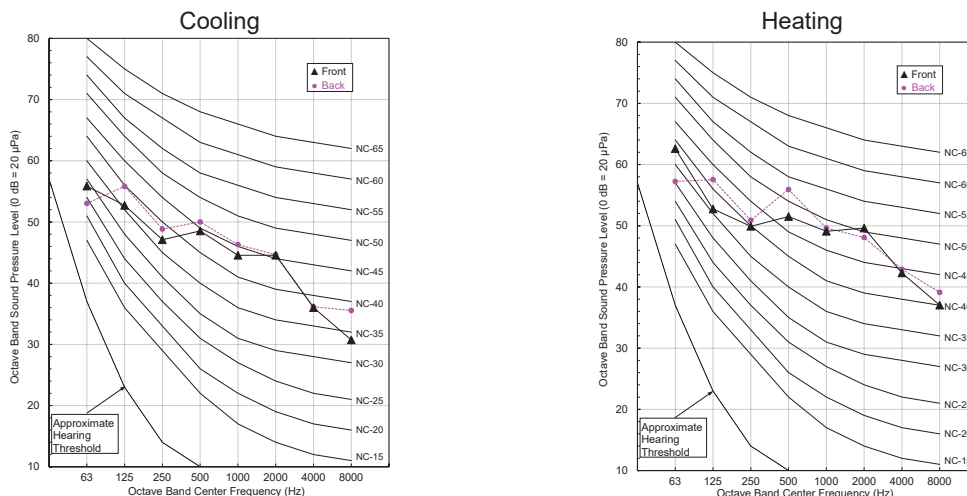

Figure 15: Sound Pressure Levels for Mega LSU240HEV2 Outdoor Units.

LSU240HEV2



ACOUSTIC DATA

Mega and Mega 115V Outdoor Units

LSU090HXV2 and LSU120HXV2 Sound Pressure Levels

Figure 16: Sound Pressure Levels for Mega 115V LSU090HXV2 Outdoor Units.

LSU090HXV2

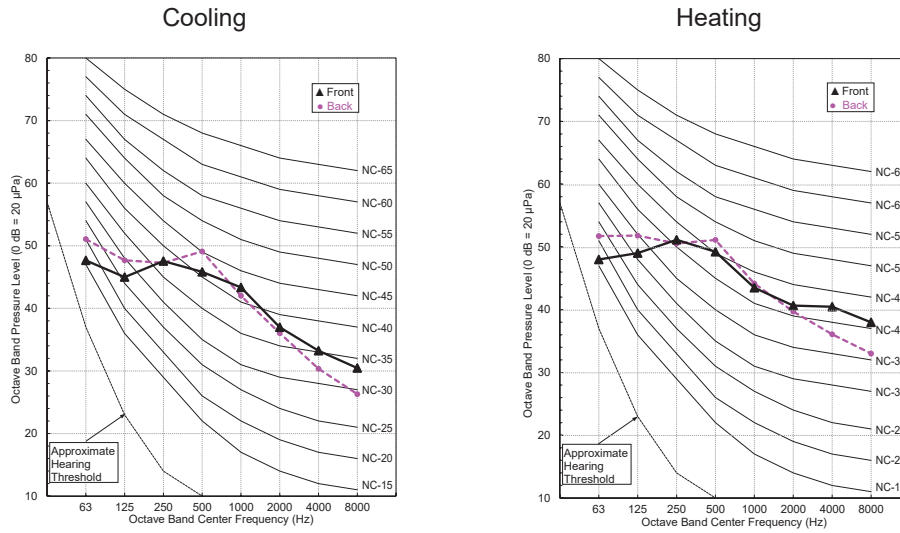
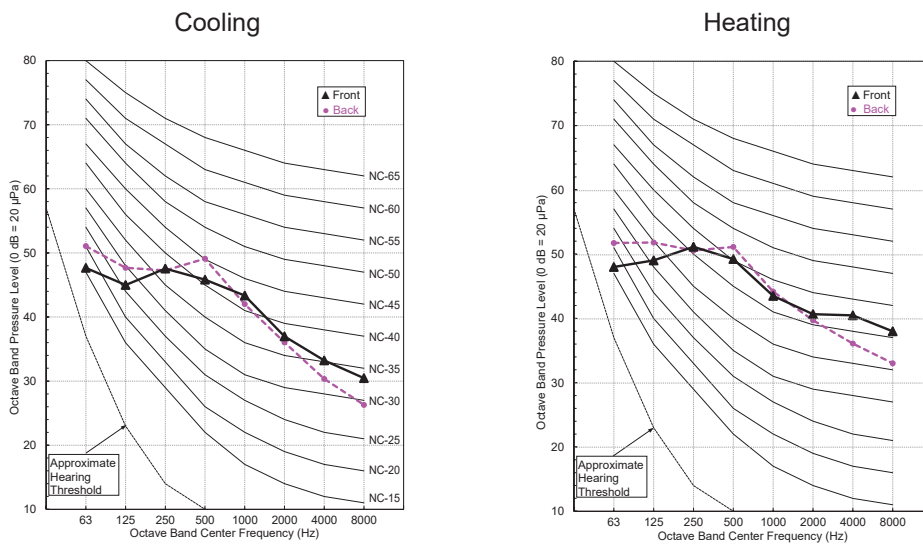

Figure 17: Sound Pressure Levels for Mega 115V LSU120HXV2 Outdoor Units.

LSU120HXV2



REFRIGERANT FLOW DIAGRAMS

Mega LSN / LSU090, 120, 180, 240HEV2

Refrigerant Flow Diagram for Mega LSN / LSU090, 120, 180, 240HEV2

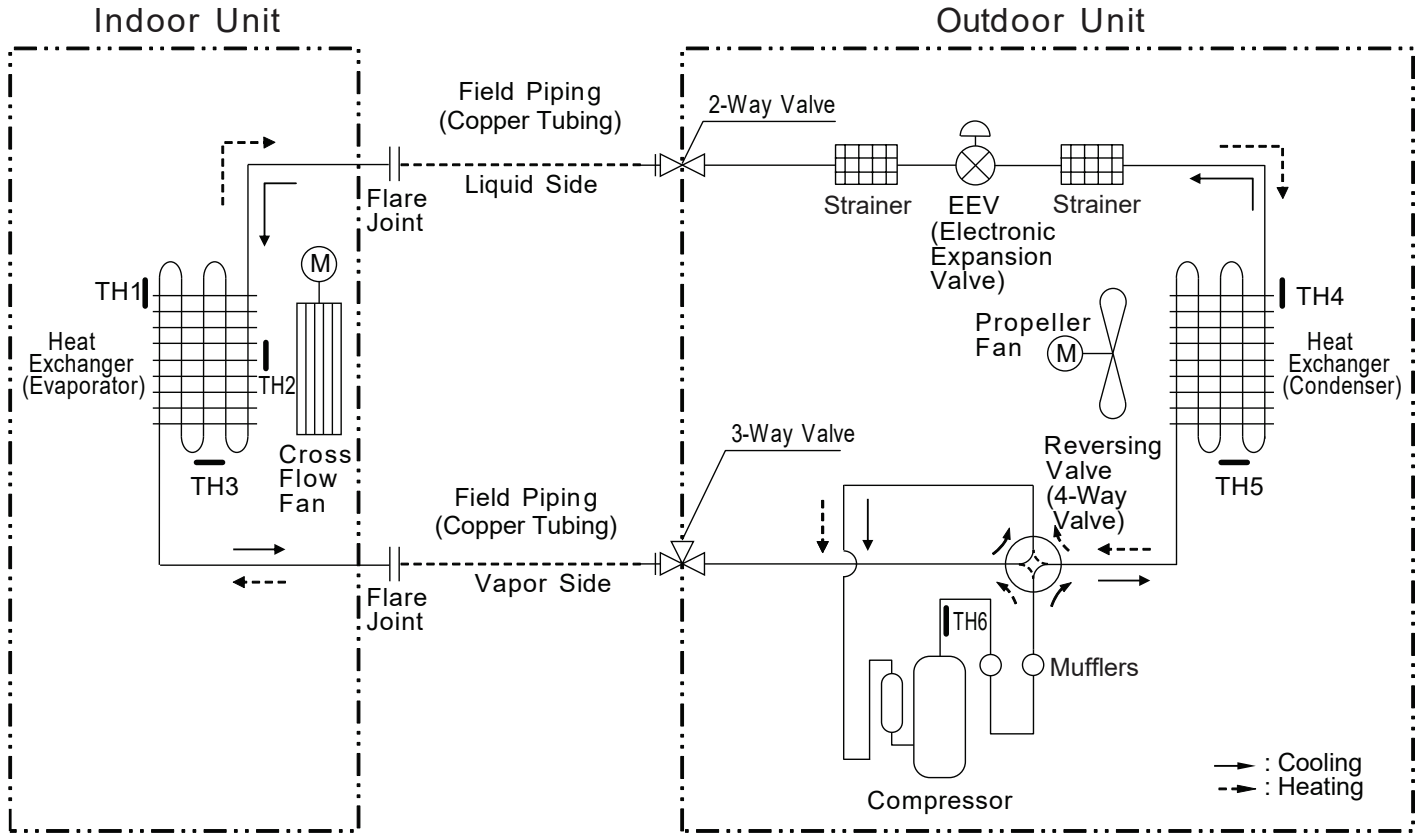

Product Data

Table 10: Mega LSN / LSU090-240HEV2 Thermistor Details.

Thermistor	Description	PCB Connector
TH1	Indoor air temperature thermistor	CN-TH1 (Indoor)
TH2	Evaporator temperature thermistor	CN-TH3 (Indoor)
TH3	Water Level Sensor (Option)	CN-TH2 (Indoor)
TH4	Outdoor air temperature thermistor	CN-TH1 (Outdoor)
TH5	Condenser temperature thermistor	
TH6	Discharge pipe temperature thermistor	CN-TH2 (Outdoor)

Table 11: Mega LSN / LSU090-240HEV2 Refrigerant Piping Sizes.

Model No.	Vapor (Inch [mm])	Liquid (Inch [mm])
LS090HEV2, LS120HEV2	Ø3/8 (Ø9.52)	Ø1/4 (Ø6.35)
LS180HEV2, LS240HEV2	Ø1/2 (Ø12.7)	Ø1/4 (Ø6.35)

REFRIGERANT FLOW DIAGRAMS

Mega 115V LSN / LSU090, 120HXV2

Refrigerant Flow Diagram for Mega 115V LSN / LSU090, 120HXV2

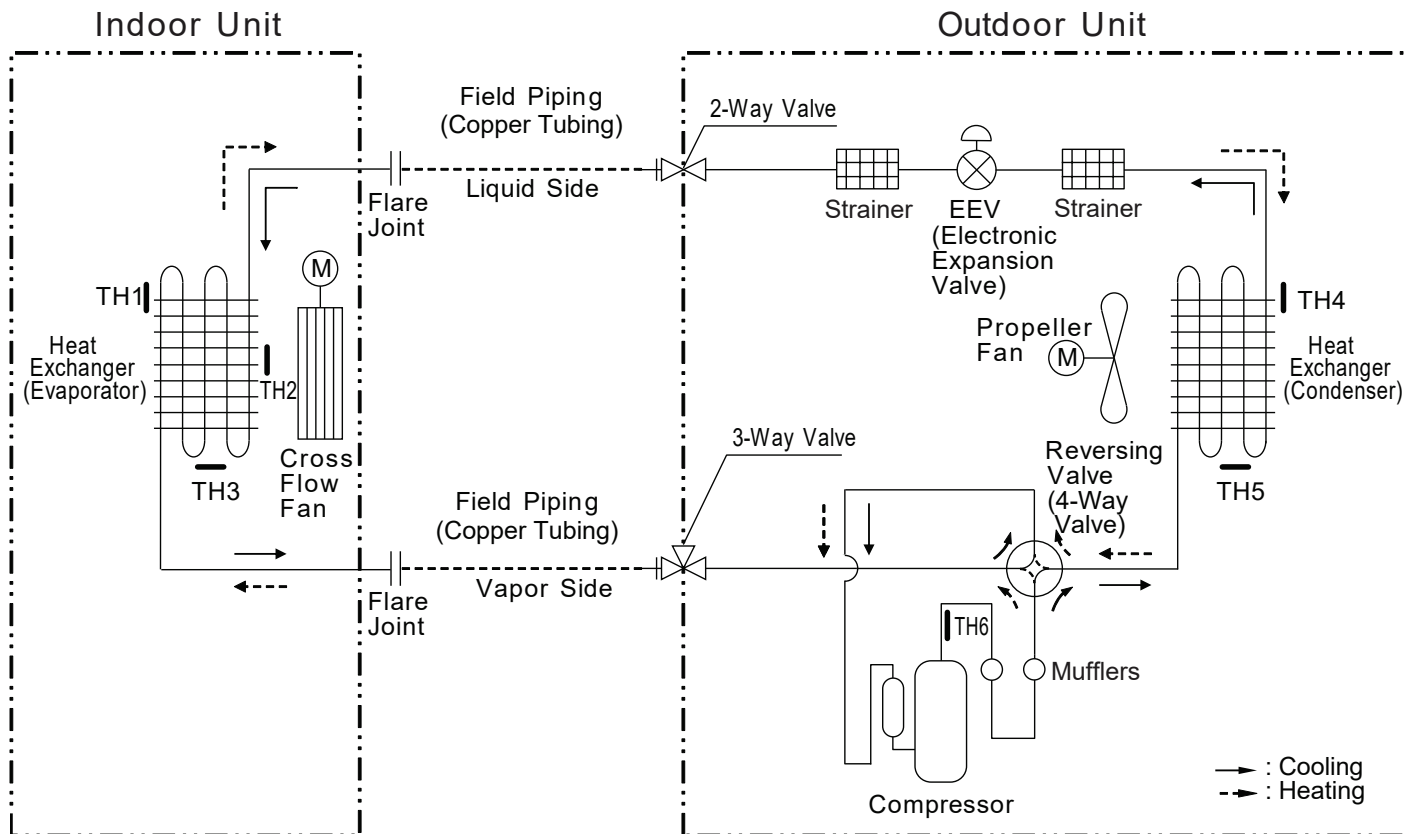

Table 12: Mega 115 LSN / LSU090-120HXV2 Thermistor Details.

Thermistor	Description	PCB Connector
TH1	Indoor air temperature thermistor	CN-TH1 (Indoor)
TH2	Evaporator temperature thermistor	CN-TH3 (Indoor)
TH3	Water Level Sensor (Option)	CN-TH2 (Indoor)
TH4	Outdoor air temperature thermistor	CN-TH1 (Outdoor)
TH5	Condenser temperature thermistor	
TH6	Discharge pipe temperature thermistor	CN-TH2 (Outdoor)

Table 13: Mega 115 LSN / LSU090-120HXV2 Refrigerant Piping Sizes.

Model No.	Vapor (Inch [mm])	Liquid (Inch [mm])
LS090HXV2, LS120HXV2	Ø3/8 (Ø9.52)	Ø1/4 (Ø6.35)

INDOOR UNIT WIRING DIAGRAM

Mega LSN090, 120, 180, 240HEV2

Wiring Diagram for Mega LSN090, 120, 180, 240HEV2

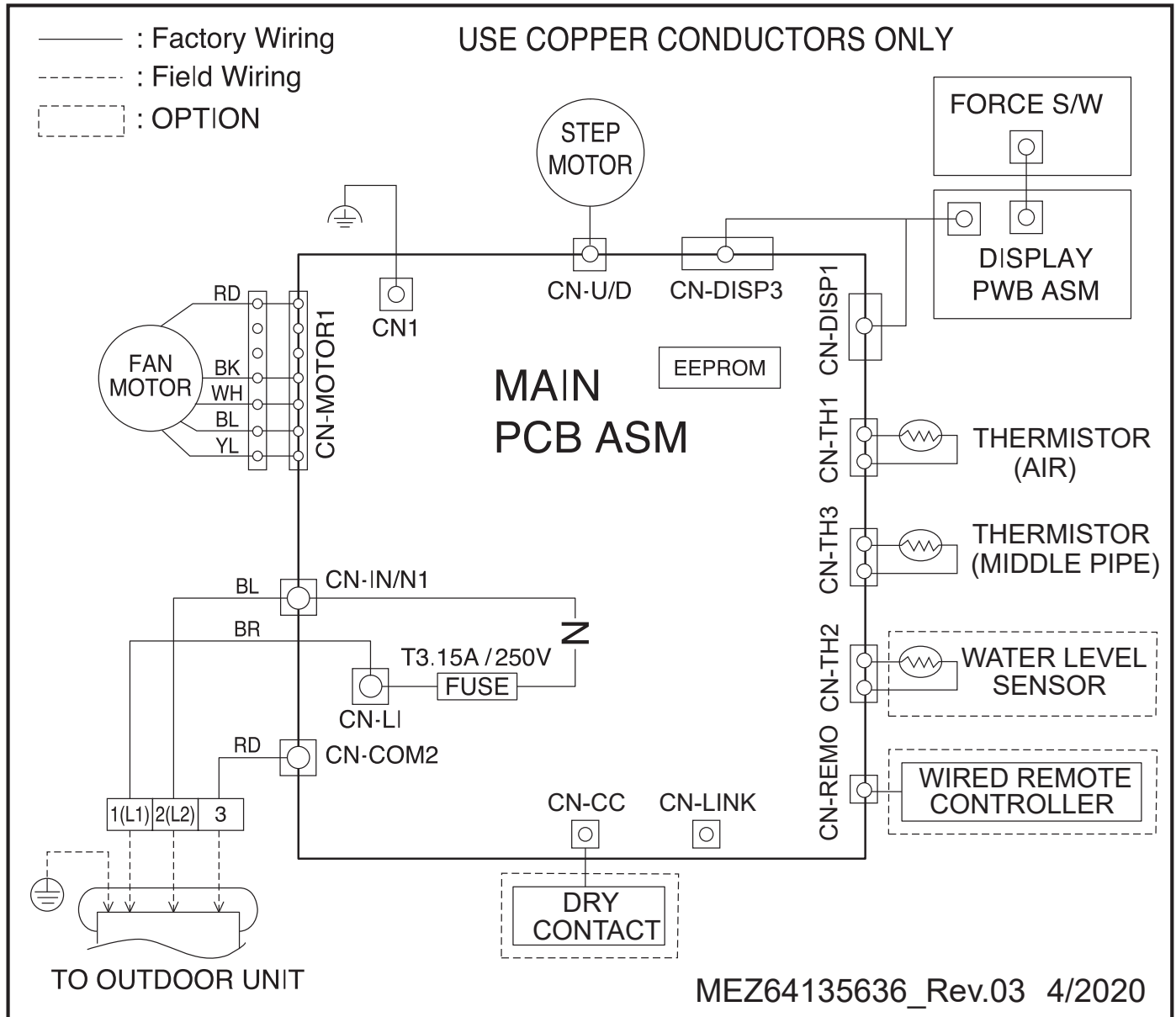

Product Data

INDOOR UNIT WIRING DIAGRAM

Mega 115V LSN090HXV2 and LSN120HXV2

Wiring Diagram for Mega 115V LSN090HXV2 and LSN120HXV2

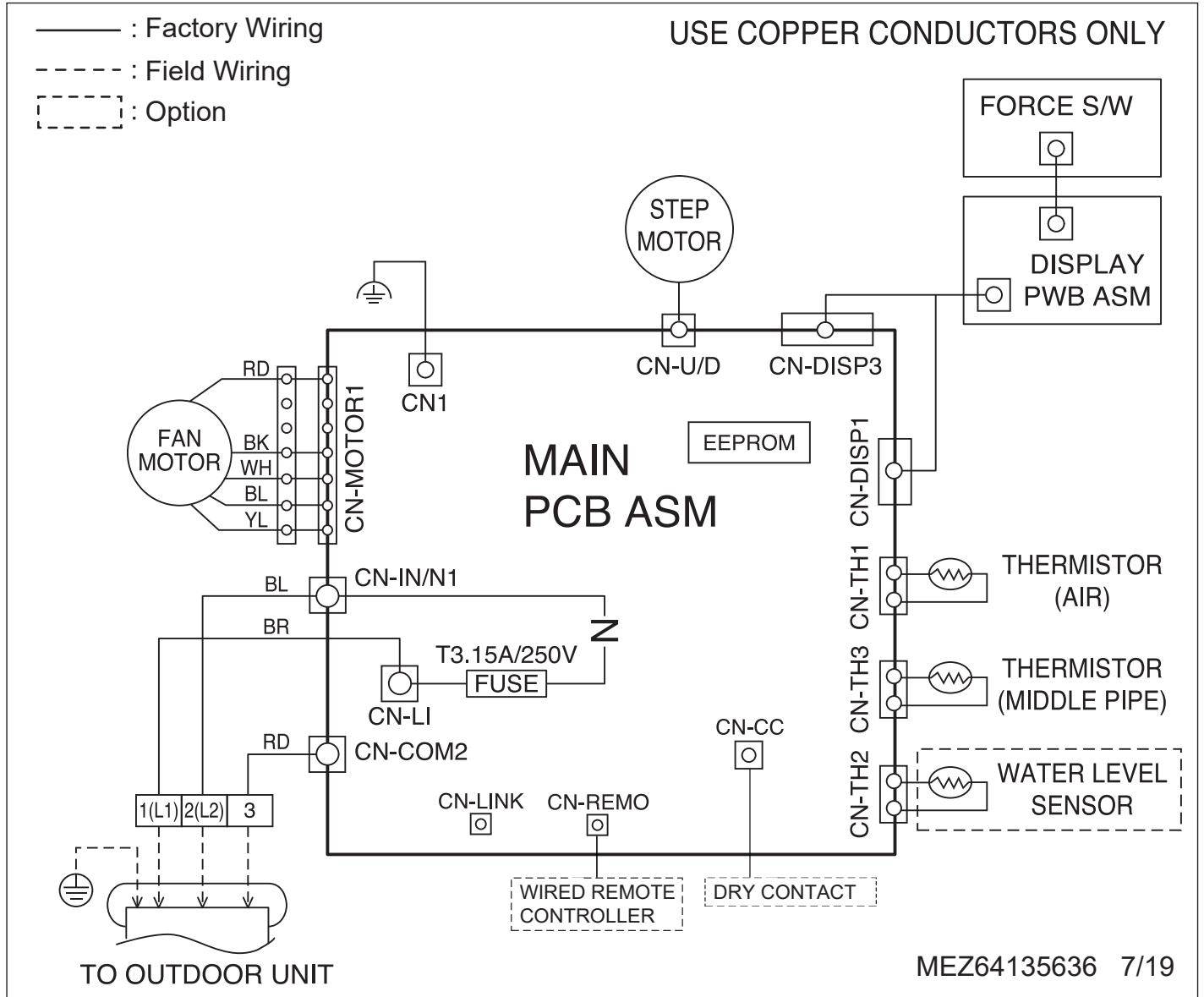

OUTDOOR UNIT WIRING DIAGRAM

Mega LSU090HEV2 and LSU120HEV2

Wiring Diagram for Mega LSU090HEV2 and LSU120HEV2

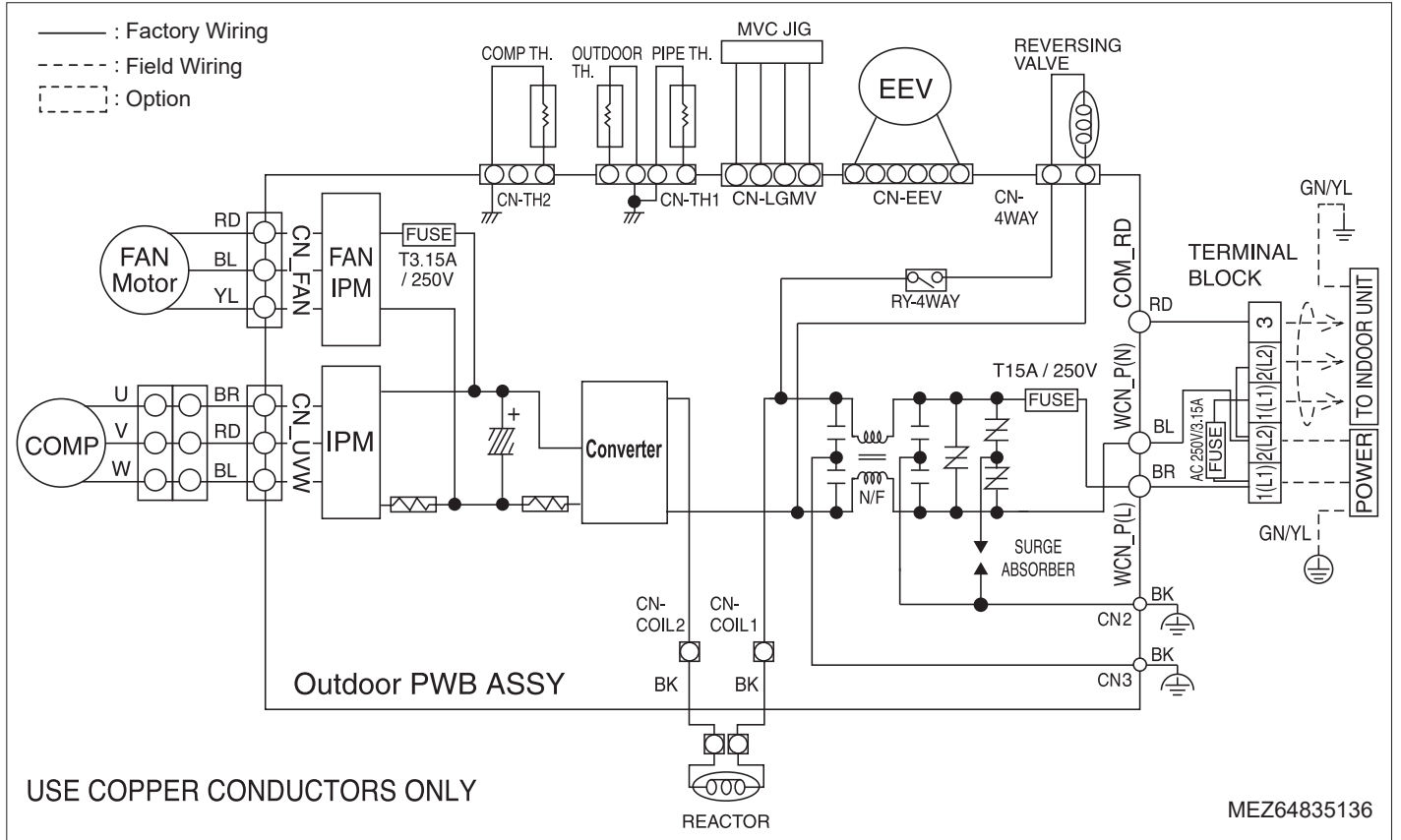

OUTDOOR UNIT WIRING DIAGRAM

Mega LSU180HEV2 and LSU240HEV2

Wiring Diagram for Mega LSU180HEV2 and LSU240HEV2

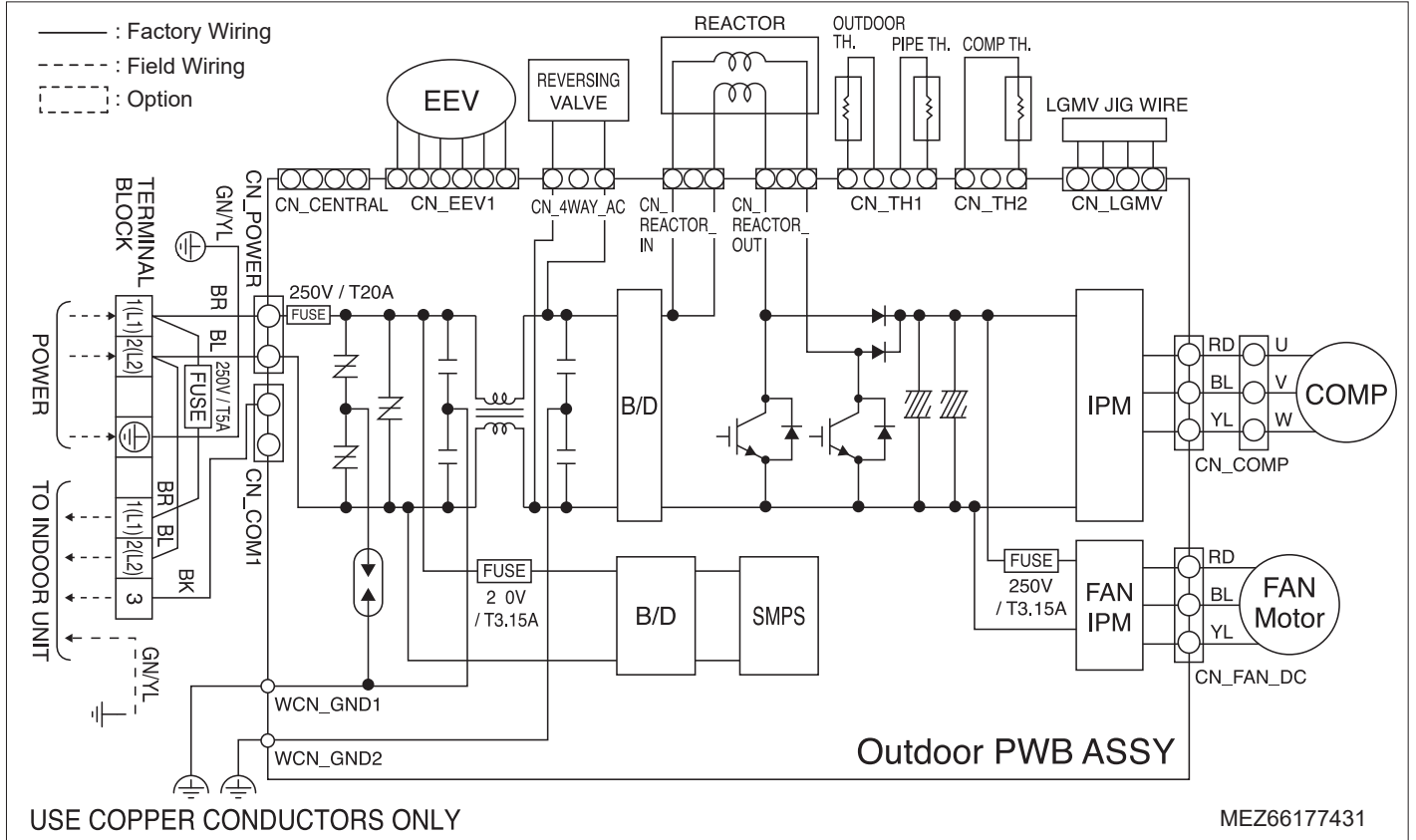

OUTDOOR UNIT WIRING DIAGRAM

Mega 115V LSU090HXV2 and LSU120HXV2

Wiring Diagram for Mega 115V LSU090HXV2 and LSU120HXV2

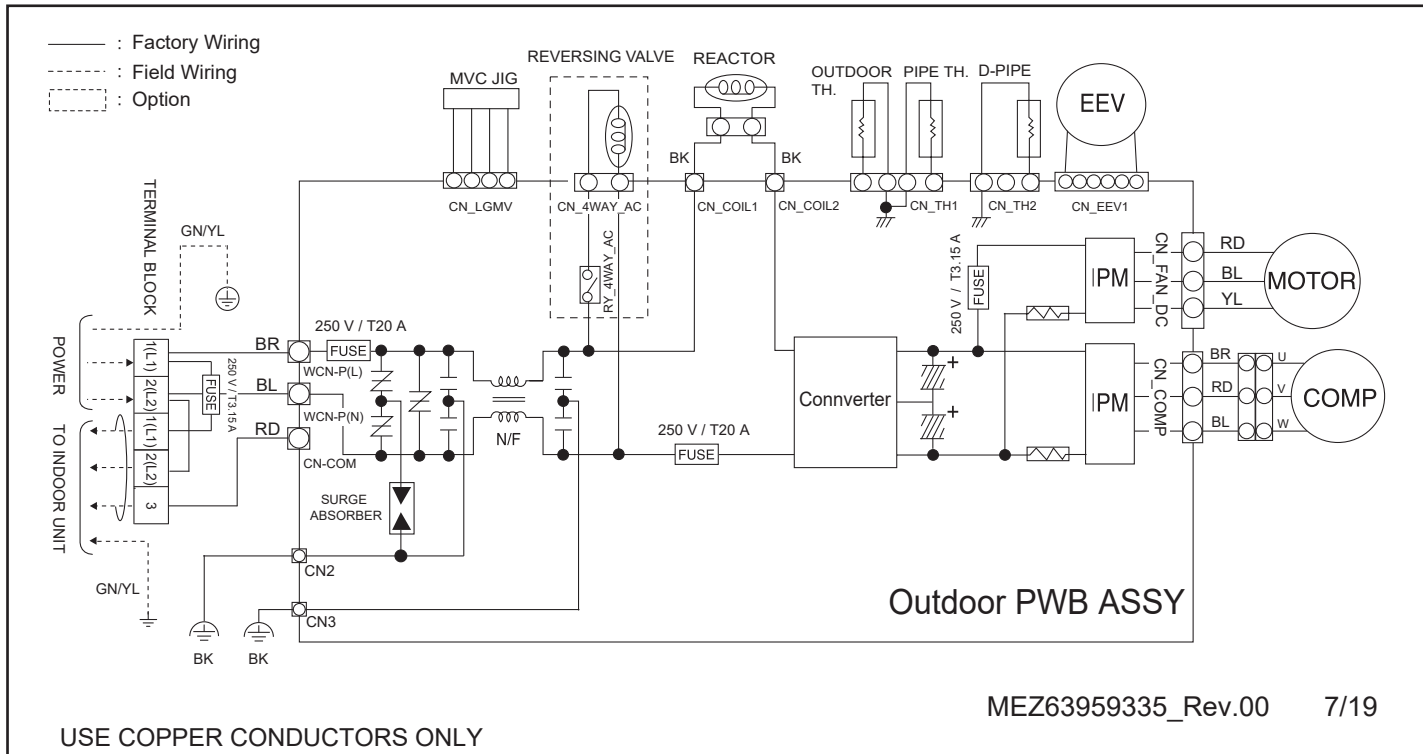

Product Data

ELECTRICAL CONNECTIONS

General Power Wiring / Communications Cable Guidelines

- Follow manufacturer's circuit diagrams displayed on the inside of the control box cover.
- Confirm power source specifications.
- Properly ground the outdoor unit and the indoor unit per National Electrical Code (NEC) and local codes.
- Connect the wiring firmly so that the wires cannot be easily pulled out.
- Confirm that the electrical capacity is sufficient.
- Power supply to the outdoor unit must be selected based on NEC and local codes. Maximum allowable voltage fluctuation $\pm 10\%$ or name-plate rated value.
- It is recommended that a circuit breaker is installed, especially if conditions could become wet or moist.
- Include a disconnect in the power wiring system. Add an air gap contact separation of at least 1/8 inch in each active (phase) conductor.
- Any openings where the field wiring enters the cabinet must be completely sealed.

⊘ Do not install power wiring to the outdoor unit and the communication / connection (power) cable from the outdoor unit to the indoor unit in the same conduit. Use separate conduits.

Power Wiring / Communications Cable Specifications

- Power wiring to the outdoor unit must be solid or stranded, and must comply with the applicable local and national electric codes.
- Communication / connection (power) cable from the outdoor unit to the indoor unit must be a minimum of 14 AWG, four (4) conductor, stranded, shielded or unshielded (if shielded, must be grounded to chassis at the outdoor unit only) and must comply with applicable local and national codes.
- Communication cable from the indoor unit to optional remote controller is to be 22 AWG, three (3) conductor, twisted, stranded, unshielded. Wiring must comply with all applicable local and national codes.

⚠ WARNING

- Terminal screws will become loose during transport. Properly tighten the terminal connections during installation or risk electric shock, physical injury, or death.
- Loose wiring will cause unit to malfunction, overheat, and catch fire, resulting in severe injury or death.

Note:

- Terminal screws will loosen during transport. Properly tighten the terminal connections during installation or risk equipment malfunction or property damage.
- Loose wiring will cause unit malfunction, the wires to burnout or the terminal to overheat and catch fire. There is a risk of equipment malfunction or property damage.

A voltage drop will cause the following problems:

- Magnetic switch vibration, fuse breaks, or disturbance to the normal function of an overload protection device.
- Compressor will not receive the proper starting current.

ELECTRICAL CONNECTIONS

Figure 18: LS090HEV2 and LS120HEV2 General Power / Communications System Schematic.

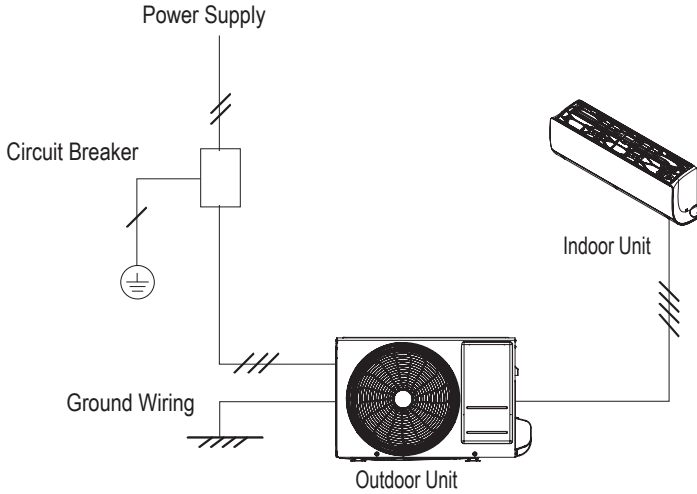

Figure 19: LS180HEV2 and LS240HEV2 General Power / Communications System Schematic.

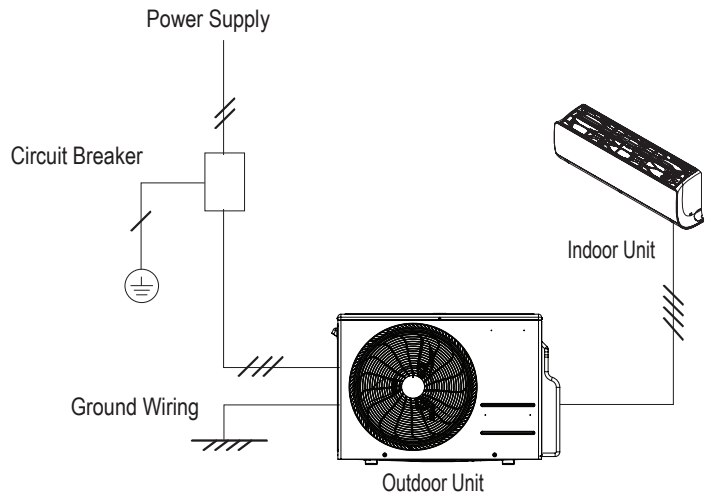

Figure 20: LS090HXV2 and LS120HXV2 General Power / Communications System Schematic.

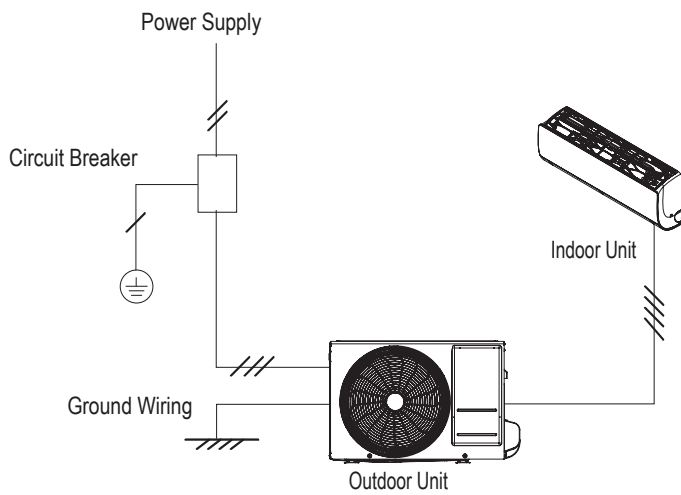
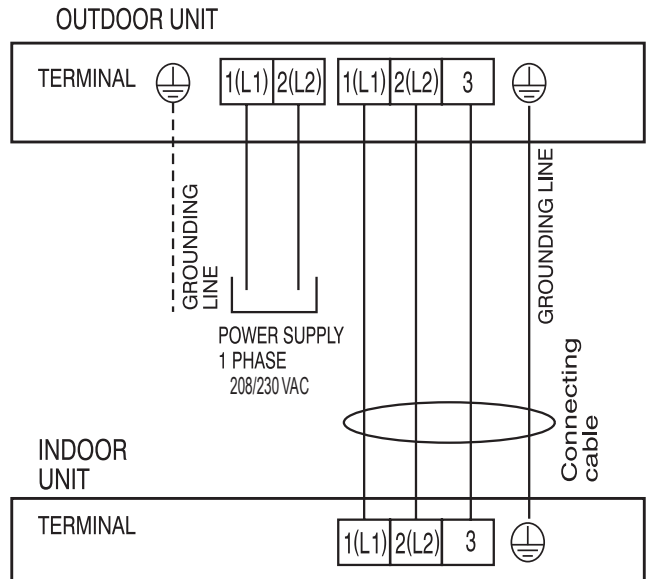

Figure 21: Terminal Block Wiring Diagram LS090-120HEV2.

LS090, 120HEV2



ELECTRICAL CONNECTIONS

Figure 22: Terminal Block Wiring Diagram LS180HEV2, LS240HEV2.
LS180HEV2, LS240HEV2

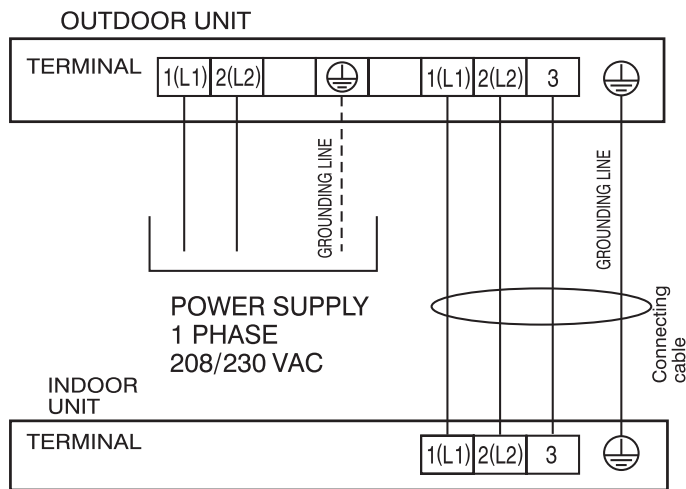
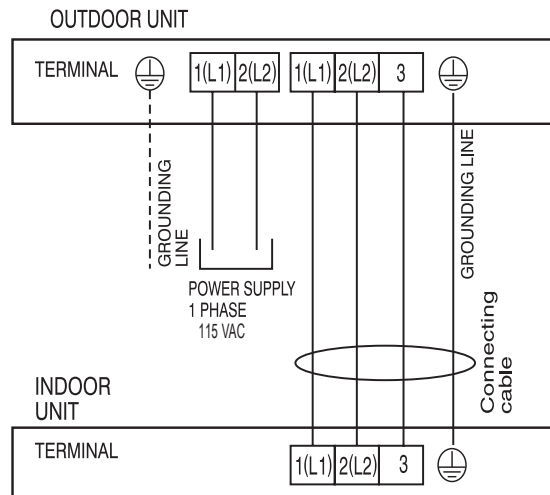

Figure 23: Terminal Block Wiring Diagram LS090HXV2, LS120HXV2
LS090, 120HXV2



Note:

- Use a conduit for the communications cable / power wiring from the outdoor unit to the indoor units.
- Make sure the communications cable / power wiring from the outdoor units to the indoor units, and the power wiring to the outdoor unit are separate, otherwise, the outdoor unit operation will be affected by electrical noise and will malfunction or fail.

Controller Options

Single Zone Mega and Mega 115V Wall Mount systems include a wireless handheld remote controller (Model No. AKB74955602). Optional LG-supplied wired controllers are available. See “Functions, Controls, Options”, or contact an LG representative for more information.

Wireless Handheld Remote Controller features:

- Display Panel: Displays operation conditions.
- On / Off Button: Turns system operation on and off.
- Mode Button: Selects the operation mode: Cooling, Heating, Auto, Dry (Dehumidification), or Fan.
- Temp Up / Down Buttons: Adjusts the desired room temperature in the different modes.
- Fan Speed Button: Sets desired fan speed.
- Reset: Initializes the handheld remote control settings.

Wired Controller Connections

Optional controllers (see “Functions, Controls, Options”, or contact an LG representative for more information) can connect to the Single Zone Mega and Mega 115V Wall Mount indoor units in one of two different ways.

1. LG Wired Remote Extension Cable with Molex plug (PZCWRC1; sold separately) that connects to the CN-REMO terminal on the indoor unit PCB.
2. Field-supplied controller cable that connects to the indoor unit terminal block (must be at least UL2547 or UL1007, and at least FT-6 rated if local electric and building codes require plenum cable usage). Communication cable from indoor unit to remote controller(s) is to be 22 AWG, 3-conductor, twisted, stranded, unshielded. Wiring must comply with all applicable local and national codes.

Figure 24: AKB74955602 Wireless Handheld Remote Controller.

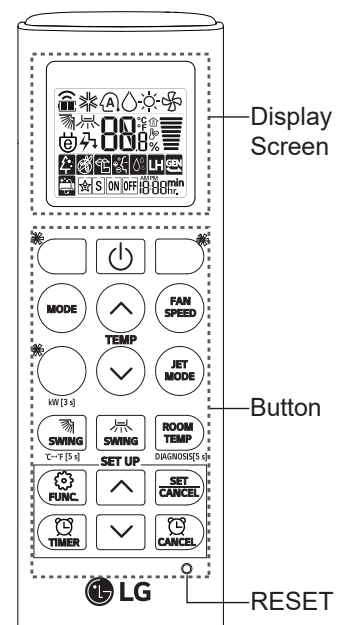

ELECTRICAL CONNECTIONS

Figure 26: PZCWRC1 LG Wired Remote Extension Cable.

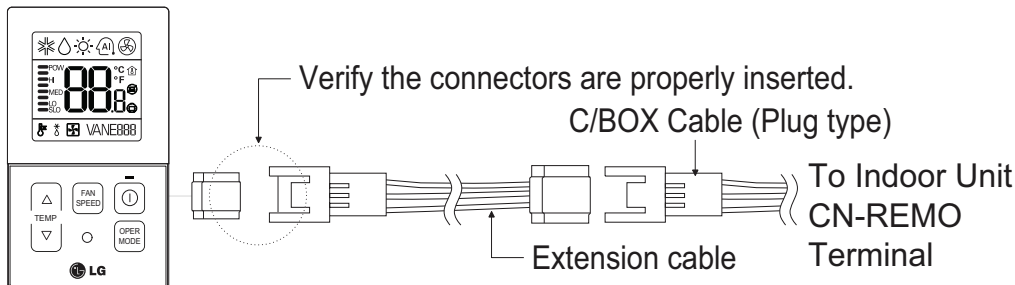
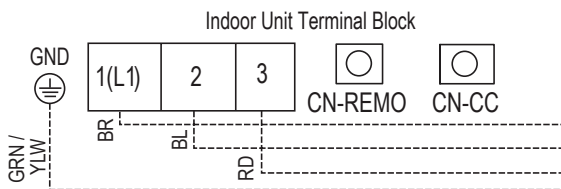

Figure 27: Wired Controller Connection on the Indoor Unit Terminal Block (Appearances and Terminal Placement Will Vary Depending on Model).

Note:

When using field-supplied controller cable, make sure to connect the yellow to yellow (communications wire), red to red (12V power wire), and black to black (ground wire) terminals from the remote controller to the indoor unit terminal blocks.



Wired Controller Placement

Wired controllers include a sensor to detect room temperature. To maintain comfort levels in the conditioned space, the wired controller must be installed in a location away from direct sunlight, high humidity, and where it could be directly exposed to cold air. Controller must be installed four (4) to five (5) feet above the floor where its LED display can be read easily, in an area with good air circulation, and where it can detect an average room temperature.

- ⊘ Do not install the wired controller near or in:
 - Drafts or dead spots behind doors and in corners.
 - Hot or cold air from ducts.
 - Radiant heat from the sun or appliances.
 - Concealed pipes and chimneys.
 - An area where temperatures are uncontrolled, such as an outside wall.

Figure 25: Proper Location for the Wired Controller.

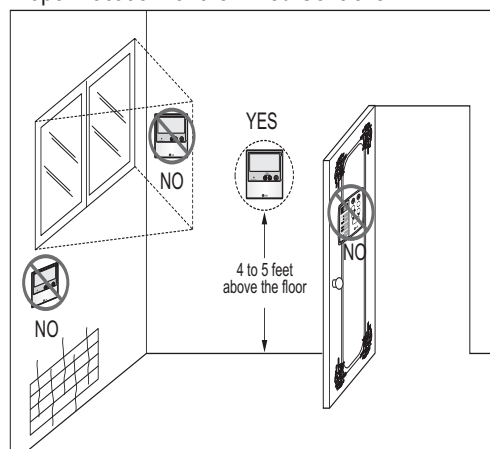

Assigning the Thermistor for Temperature Detection

Each indoor unit includes a return air thermistor assigned to sense the temperature. If a wired controller is installed, there is a choice of sensing temperature with either the indoor unit return air thermistor or the thermistor in the wired controller. It is also an option to set both thermistors to sense temperature so that indoor unit bases its operation on the first thermistor to reach the designated temperature differential.

AIR FLOW, STATIC PRESSURE, AND TEMPERATURE DISTRIBUTION

Table 14: Mega and Mega 115V Outdoor Unit Air Flow Rate and Static Pressure.

Model No.	Air Flow Rate (CFM)	Static Pressure (in. WG)
<i>Mega</i>		
LSU090HEV2, LSU120HEV2	953	0.0284
LSU180HEV2, LSU240HEV2	1,730	0.0387
<i>Mega 115V</i>		
LSU090HXV2, LSU120HXV2	953	0.0284

LSN090HEV2

Cooling

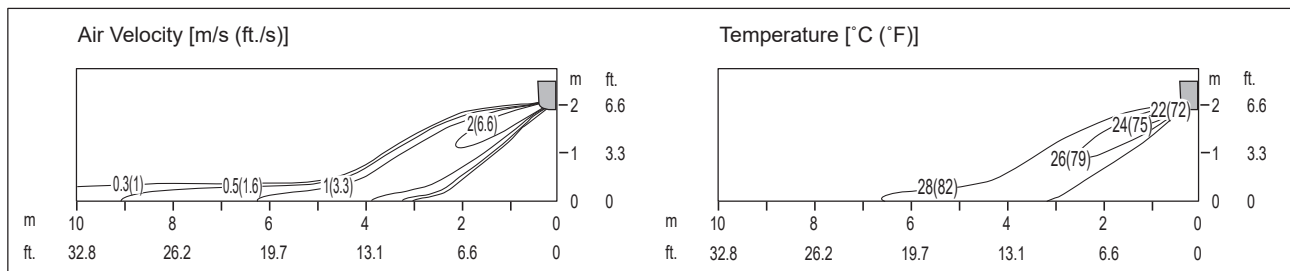

Side View

Discharge Angle : 35° (From the floor ↘)

Vertical Louver : Center

Fan Speed : Power

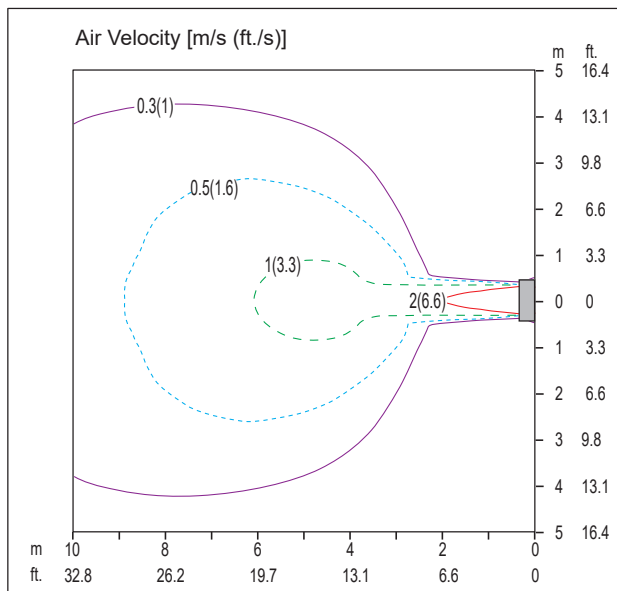

Top View

Discharge Angle : 35° (From the floor ↘)

Vertical Louver : Center

Fan Speed : Power

Air Speed 0.3 m/s (1 ft./s) Range : 11.5 m (37.7 ft.)

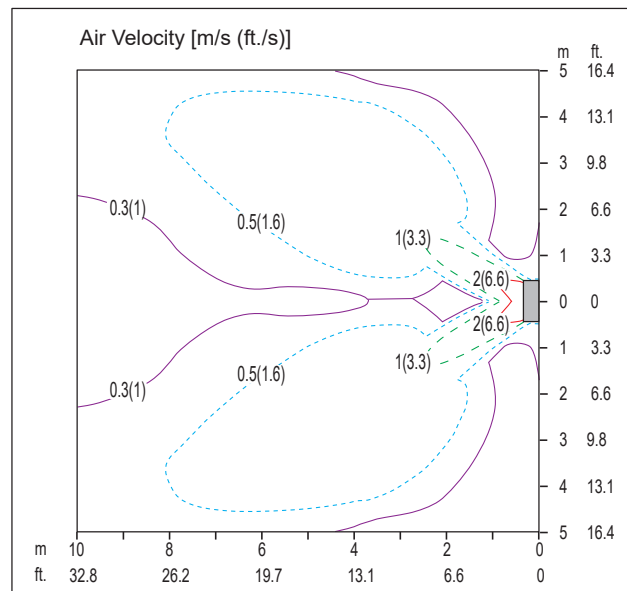

Top View

Discharge Angle : 35° (From the floor ↘)

Vertical Louver : Left & Right

Fan Speed : Power

AIR FLOW AND TEMPERATURE DISTRIBUTION

LSN090HEV2, continued.

Heating

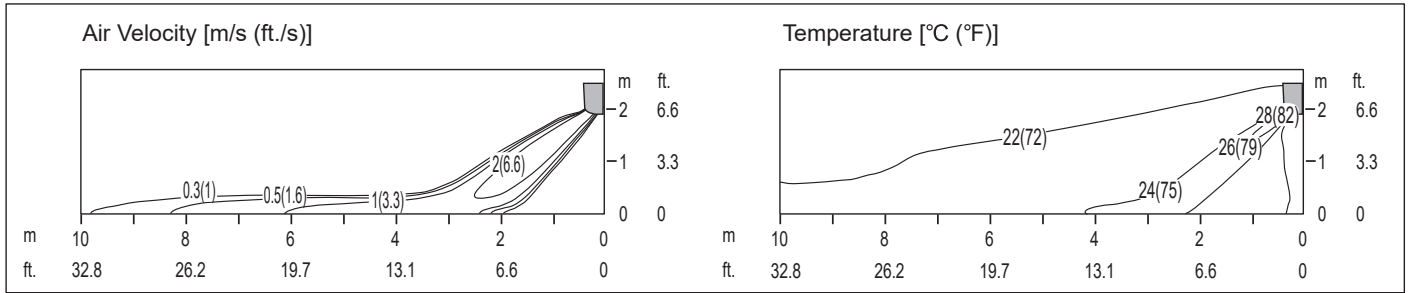

Side View

Discharge Angle : 55° (From the floor ▾)

Vertical Louver : Center

Fan Speed : Power

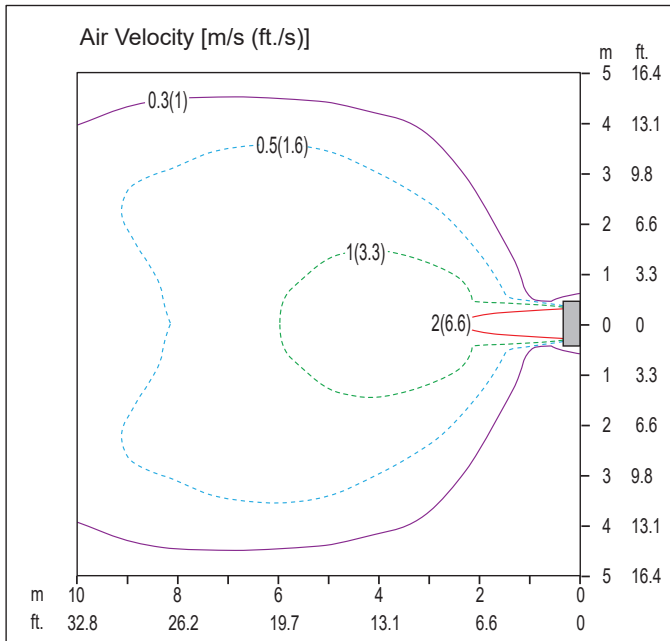

Top View

Discharge Angle : 55° (From the floor ▾)

Vertical Louver : Center

Fan Speed : Power

Air Speed 0.3 m/s (1 ft./s) Range : 10.2 m (33.5 ft.)

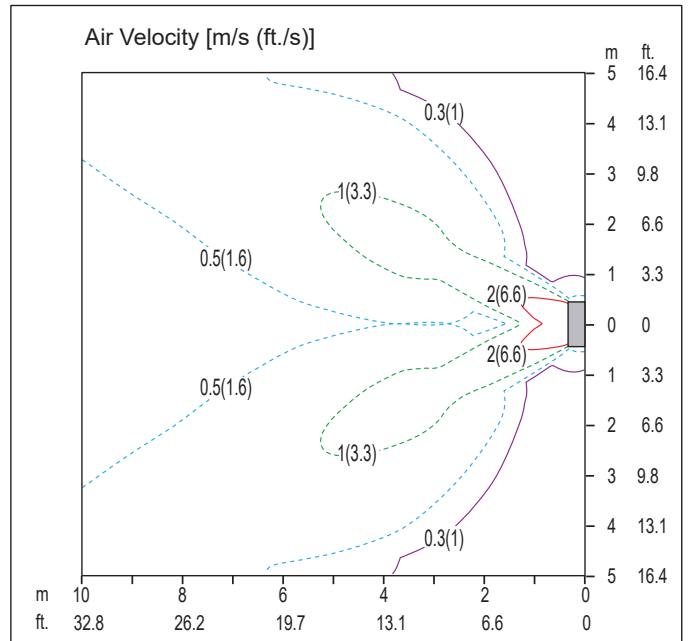

Top View

Discharge Angle : 55° (From the floor ▾)

Vertical Louver : Left & Right

Fan Speed : Power

AIR FLOW AND TEMPERATURE DISTRIBUTION

LSN120HEV2

Cooling

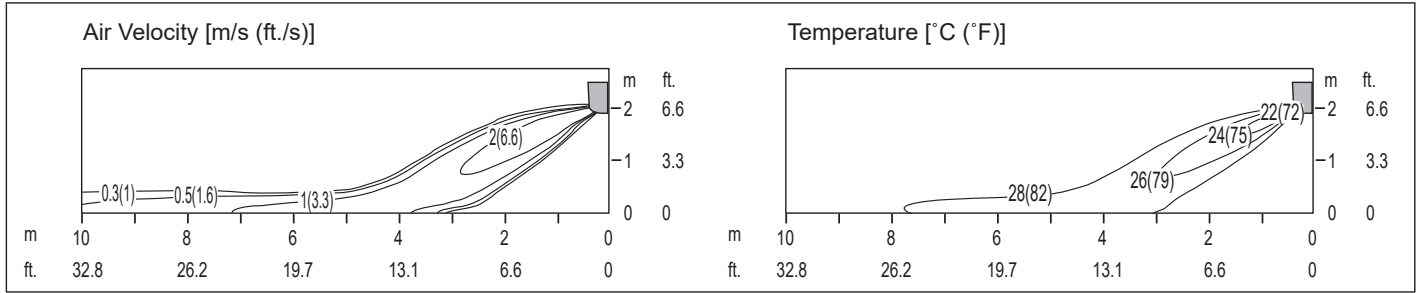

Side View

Discharge Angle : 35° (From the floor)

Vertical Louver : Center

Fan Speed : Power

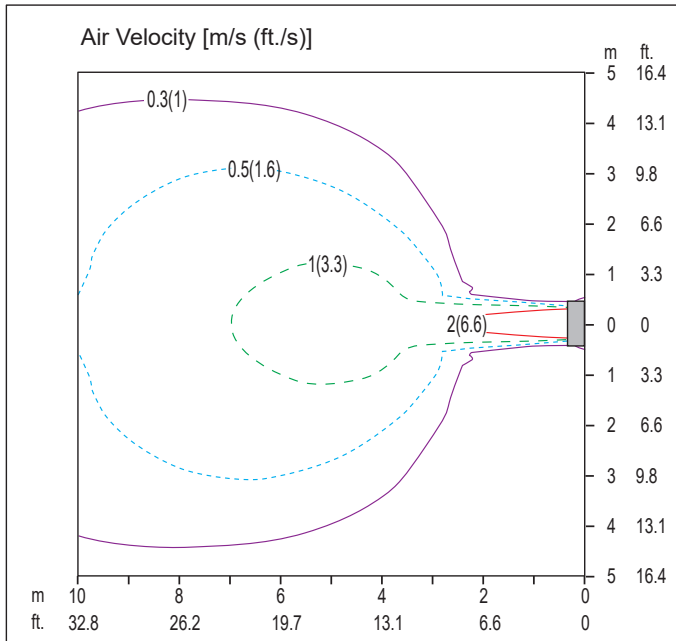

Top View

Discharge Angle : 35° (From the floor)

Vertical Louver : Center

Fan Speed : Power

Air Speed 0.3 m/s (1 ft./s) Range : 13.0 m (42.7 ft.)

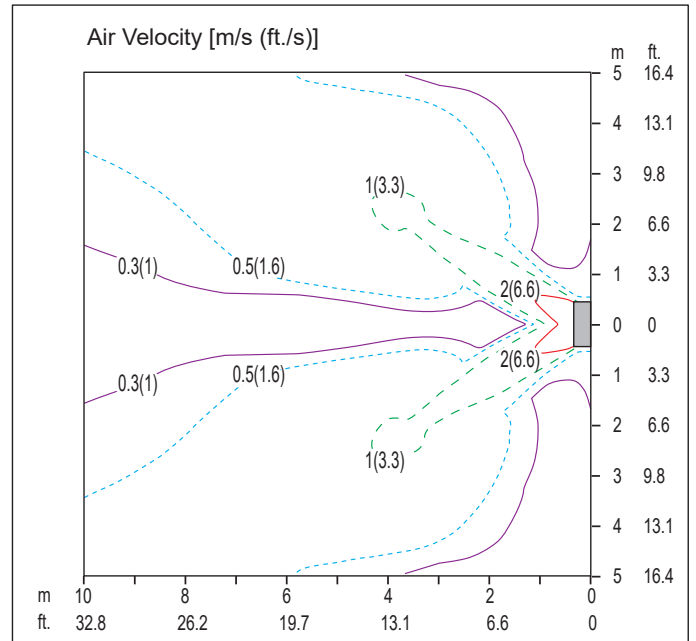

Top View

Discharge Angle : 35° (From the floor)

Vertical Louver : Left & Right

Fan Speed : Power

AIR FLOW AND TEMPERATURE DISTRIBUTION

LSN120HEV2, continued.

Heating

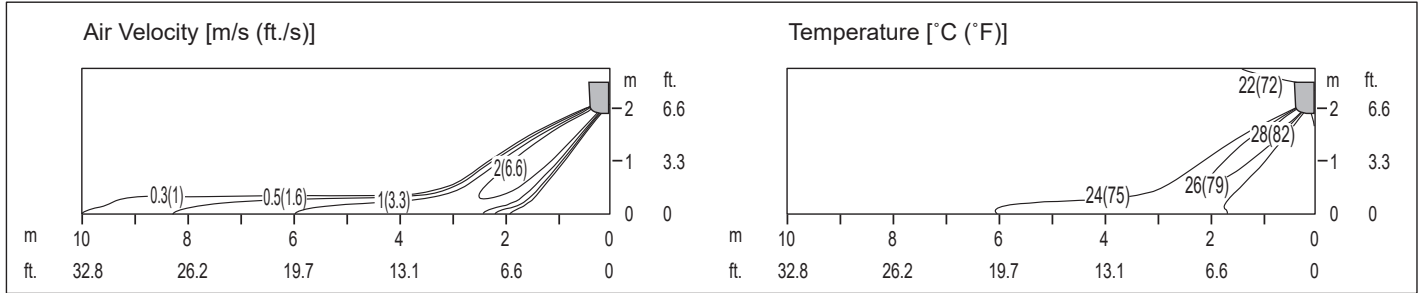

Side View

Discharge Angle : 55° (From the floor ↘)

Vertical Louver : Center

Fan Speed : Power

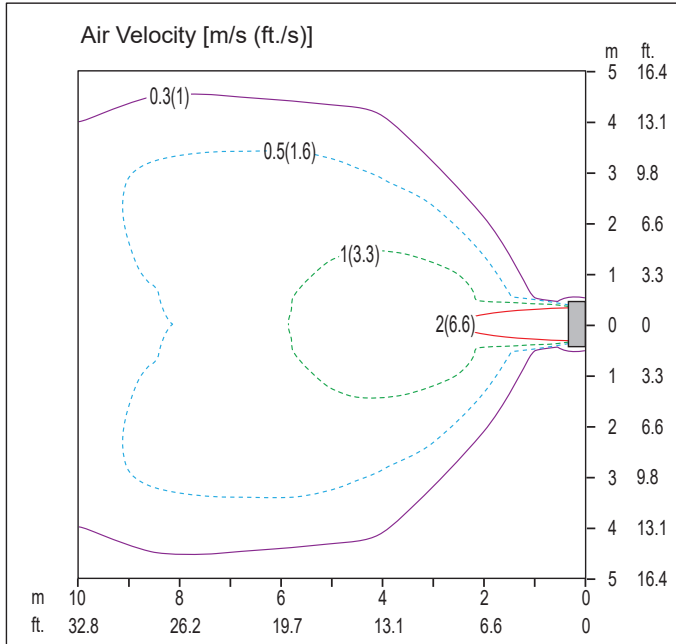

Top View

Discharge Angle : 55° (From the floor ↘)

Vertical Louver : Center

Fan Speed : Power

Air Speed 0.3 m/s (1 ft./s) Range : 10.5 m (34.4 ft.)

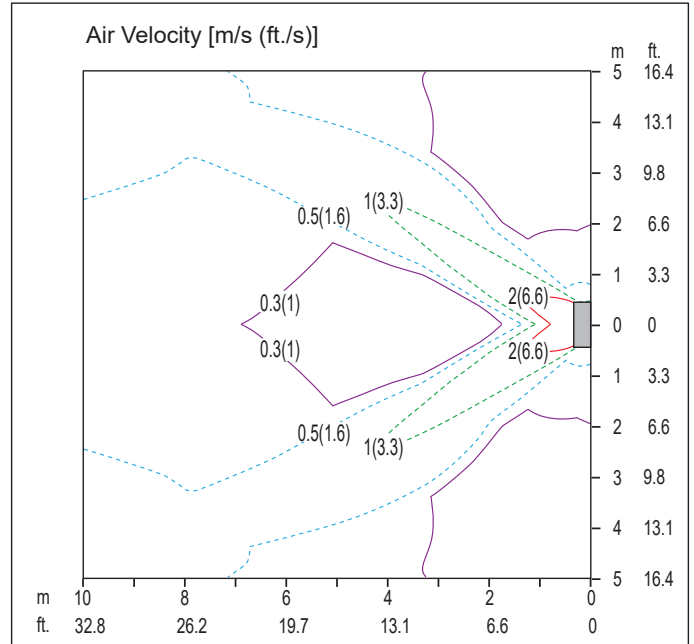

Top View

Discharge Angle : 55° (From the floor ↘)

Vertical Louver : Left & Right

Fan Speed : Power

AIR FLOW AND TEMPERATURE DISTRIBUTION

LSN180HEV2

Cooling

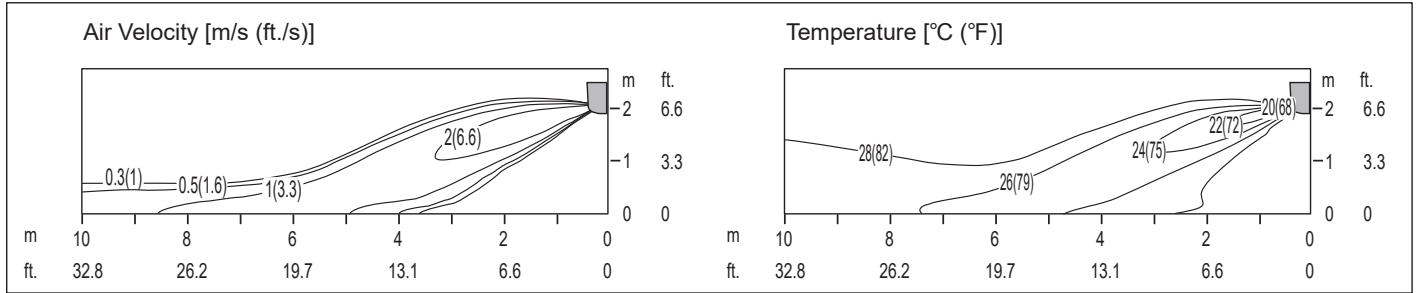

Side View

Discharge Angle : 25° (From the floor )

Vertical Louver : Center

Fan Speed : Power

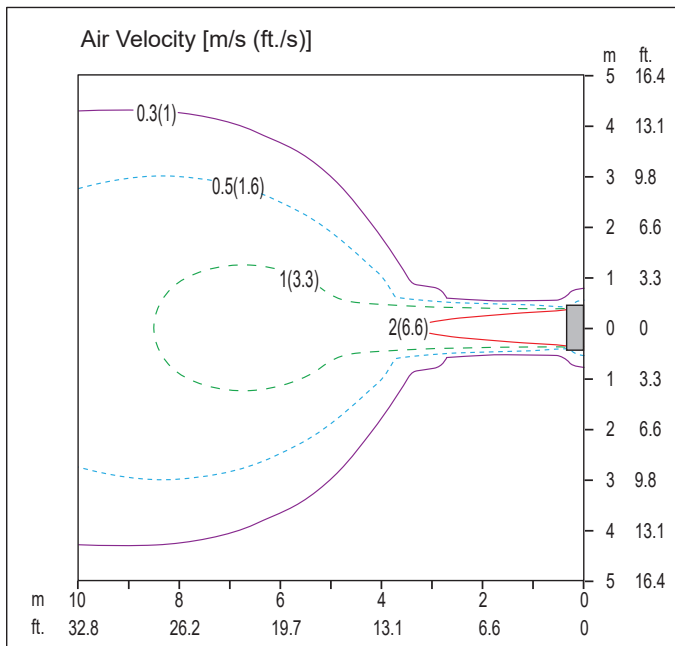

Top View

Discharge Angle : 25° (From the floor )

Vertical Louver : Center

Fan Speed : Power

Air Speed 0.3 m/s (1 ft./s) Range : 15.8 m (51.8 ft.)

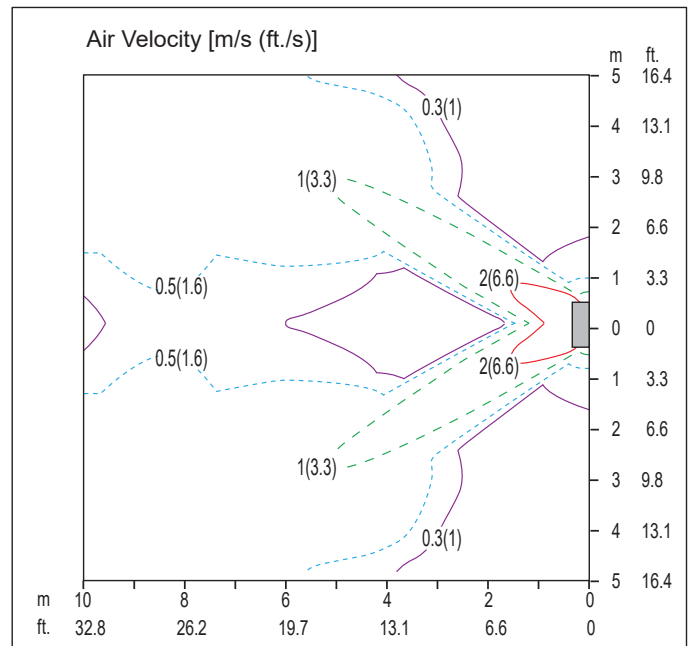

Top View

Discharge Angle : 25° (From the floor )

Vertical Louver : Left & Right

Fan Speed : Power

AIR FLOW AND TEMPERATURE DISTRIBUTION

LSN180HEV2, continued.

Heating

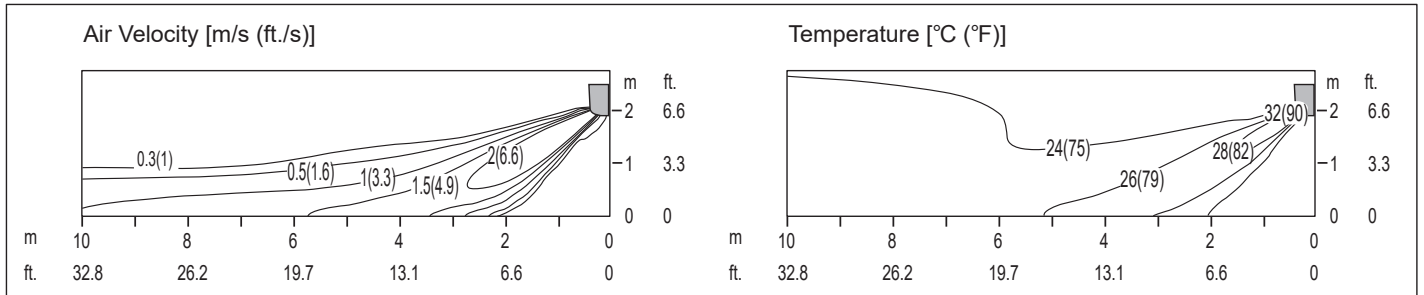

Side View

Discharge Angle : 45° (From the floor 🏠)

Vertical Louver : Center

Fan Speed : Power

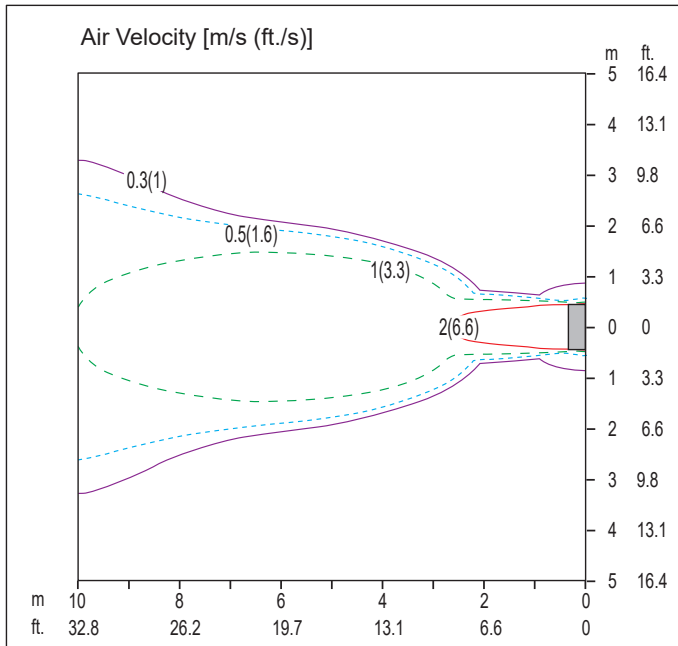

Top View

Discharge Angle : 45° (From the floor 🏠)

Vertical Louver : Center

Fan Speed : Power

Air Speed 0.3 m/s (1 ft./s) Range : 18.0 m (59.1 ft.)

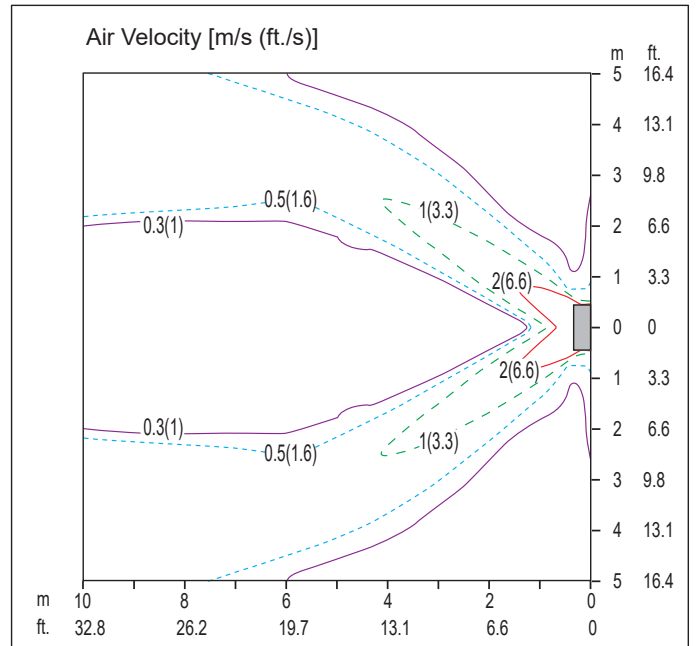

Top View

Discharge Angle : 45° (From the floor 🏠)

Vertical Louver : Left & Right

Fan Speed : Power

AIR FLOW AND TEMPERATURE DISTRIBUTION

LSN240HEV2

Cooling

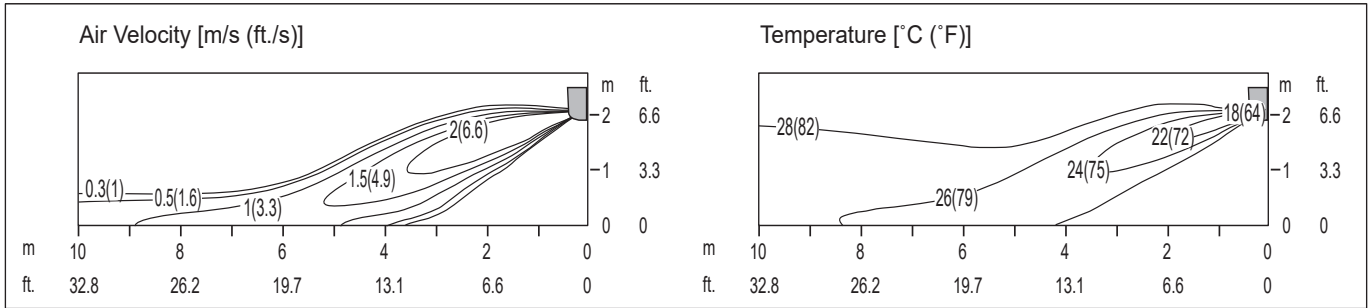

Side View

Discharge Angle : 25° (From the floor ▼)

Vertical Louver : Center

Fan Speed : Power

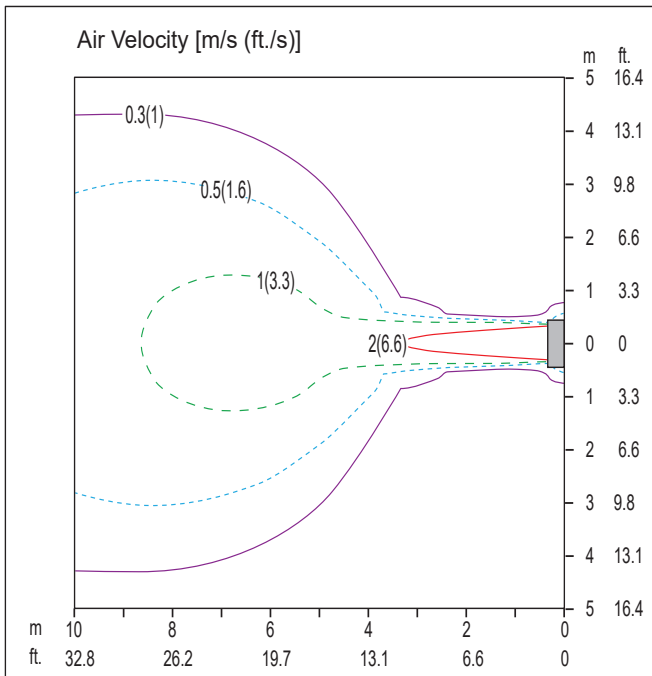

Top View

Discharge Angle : 25° (From the floor ▼)

Vertical Louver : Center

Fan Speed : Power

Air Speed 0.3 m/s (1 ft./s) Range : 16.1 m (52.8 ft.)

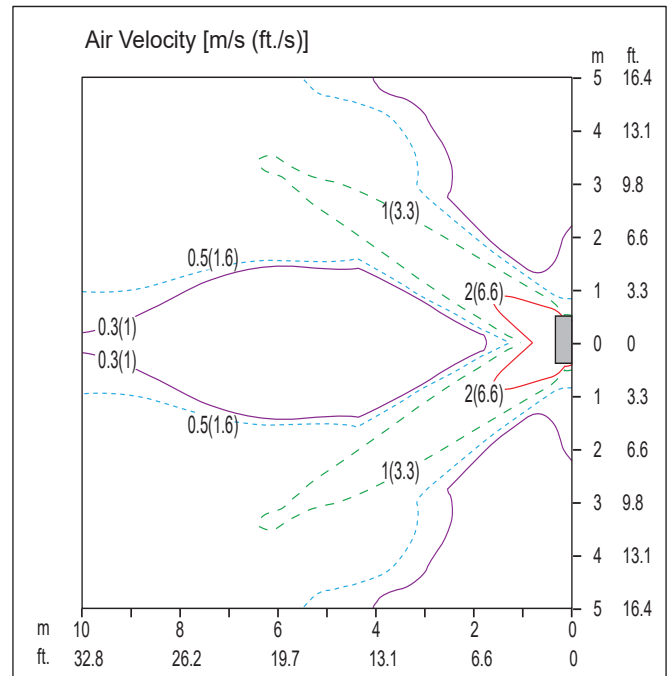

Top View

Discharge Angle : 25° (From the floor ▼)

Vertical Louver : Left & Right

Fan Speed : Power

AIR FLOW AND TEMPERATURE DISTRIBUTION

LSN240HEV2, continued.

Heating

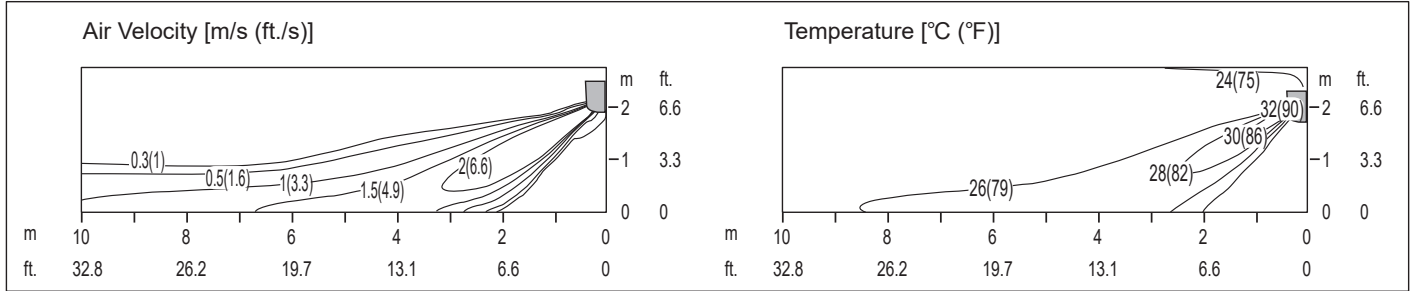

Side View

Discharge Angle : 45° (From the floor ▾)

Vertical Louver : Center

Fan Speed : Power

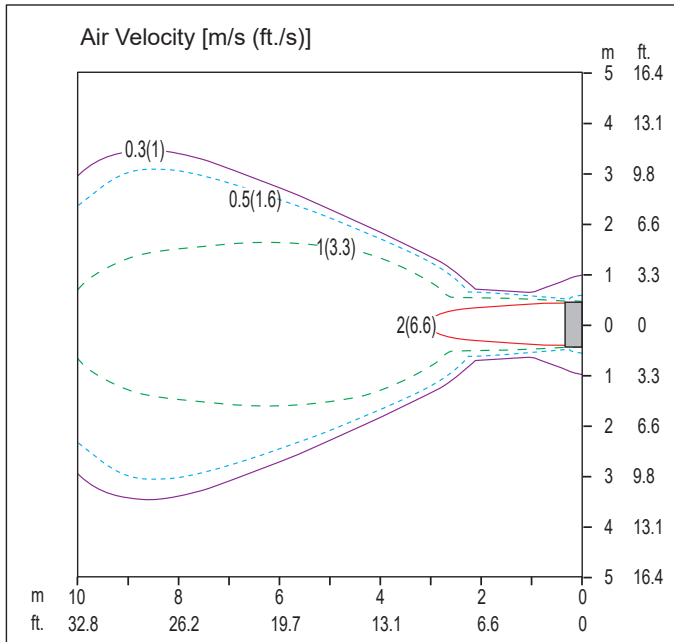

Top View

Discharge Angle : 45° (From the floor ▾)

Vertical Louver : Center

Fan Speed : Power

Air Speed 0.3 m/s (1 ft./s) Range : 18.3 m (60.0 ft.)

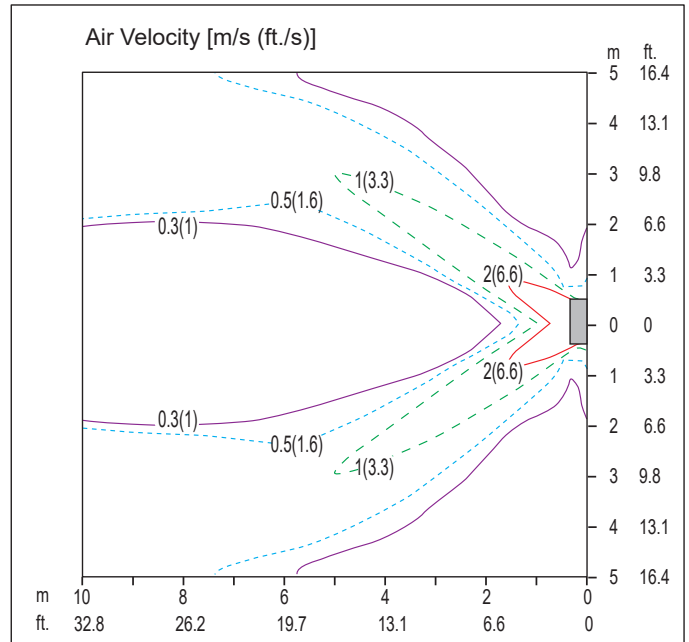

Top View

Discharge Angle : 45° (From the floor ▾)

Vertical Louver : Left & Right

Fan Speed : Power

AIR FLOW AND TEMPERATURE DISTRIBUTION

LSN090HXV2

Cooling

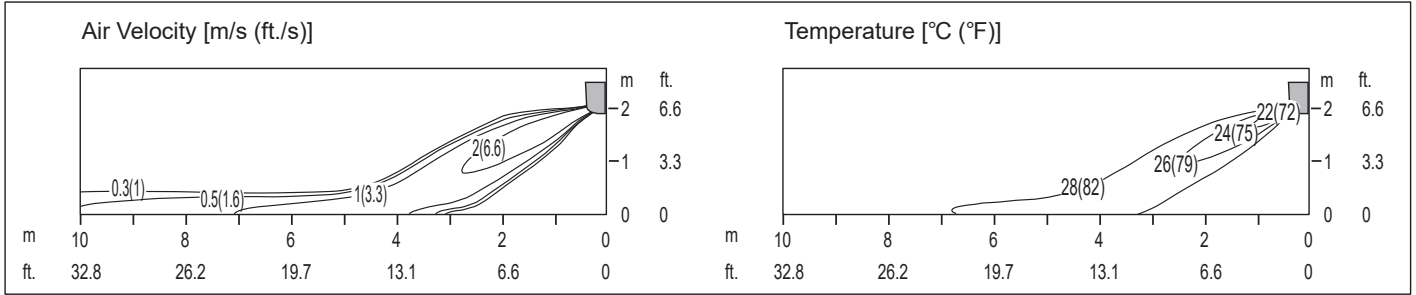

Side View

Discharge Angle : 35° (From the floor ↘)

Vertical Louver : Center

Fan Speed : Power

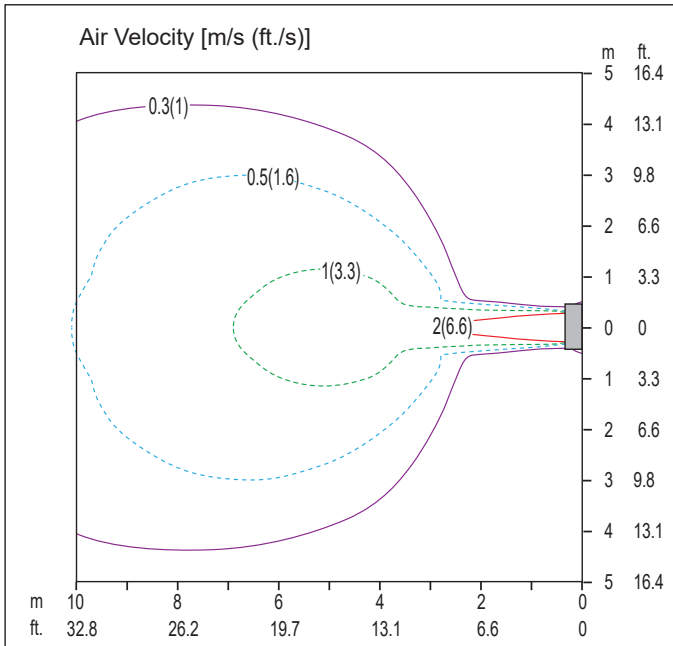

Top View

Discharge Angle : 35° (From the floor ↘)

Vertical Louver : Center

Fan Speed : Power

Air Speed 0.3 m/s (1 ft./s) Range : 13.0 m (42.7 ft.)

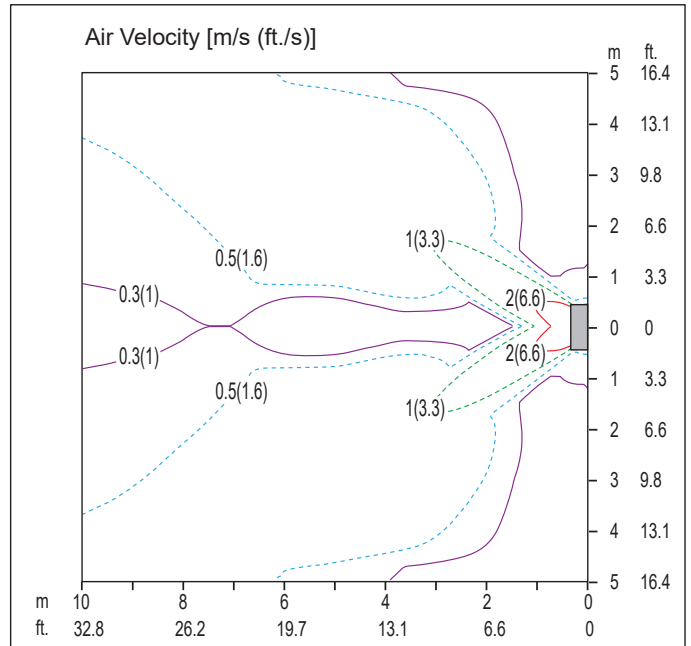

Top View

Discharge Angle : 35° (From the floor ↘)

Vertical Louver : Left & Right

Fan Speed : Power

AIR FLOW AND TEMPERATURE DISTRIBUTION

LSN090HXV2, continued.

Heating

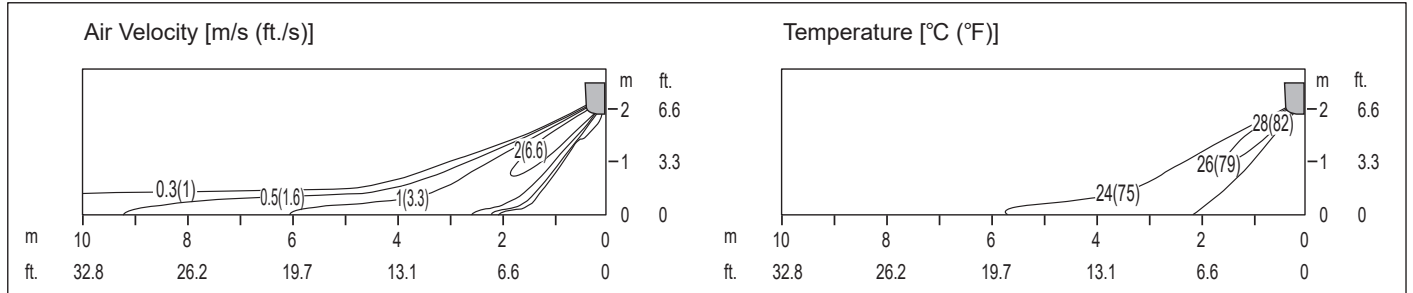

Side View

Discharge Angle : 55° (From the floor 🏠)

Vertical Louver : Center

Fan Speed : Power

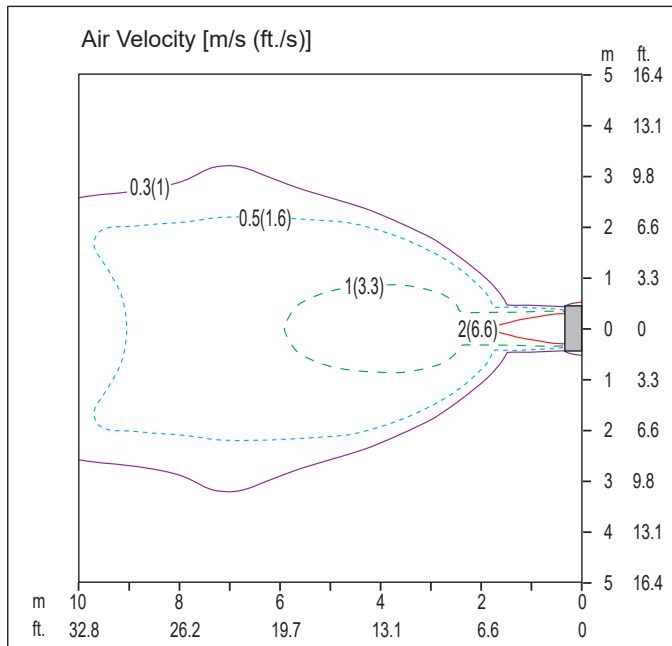

Top View

Discharge Angle : 55° (From the floor 🏠)

Vertical Louver : Center

Fan Speed : Power

Air Speed 0.3 m/s (1 ft./s) Range : 10.5 m (34.4 ft.)

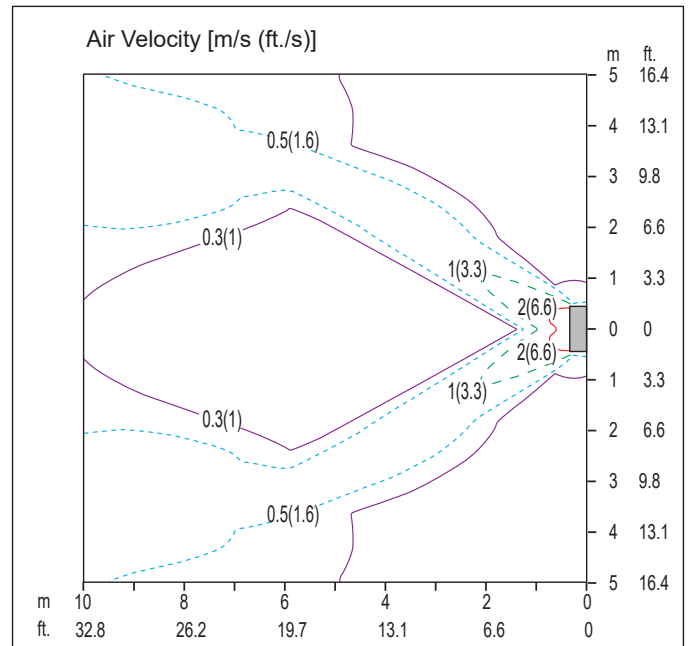

Top View

Discharge Angle : 55° (From the floor 🏠)

Vertical Louver : Left & Right

Fan Speed : Power

AIR FLOW AND TEMPERATURE DISTRIBUTION

LSN120HXV2

Cooling

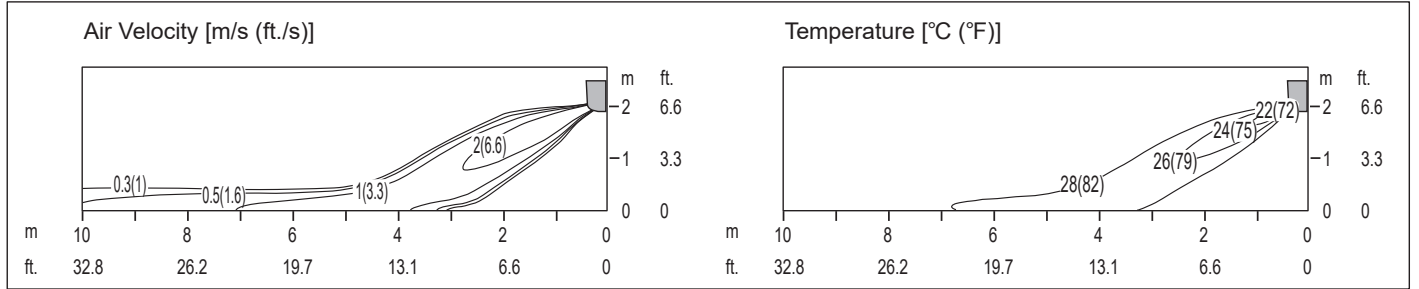

Side View

Discharge Angle : 35° (From the floor ▾)

Vertical Louver : Center

Fan Speed : Power

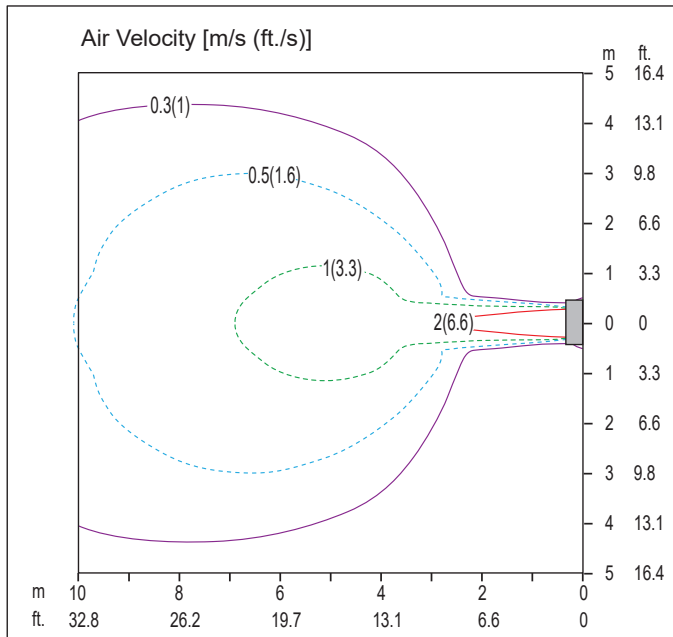

Top View

Discharge Angle : 35° (From the floor ▾)

Vertical Louver : Center

Fan Speed : Power

Air Speed 0.3 m/s (1 ft./s) Range : 13.0 m (42.7 ft.)

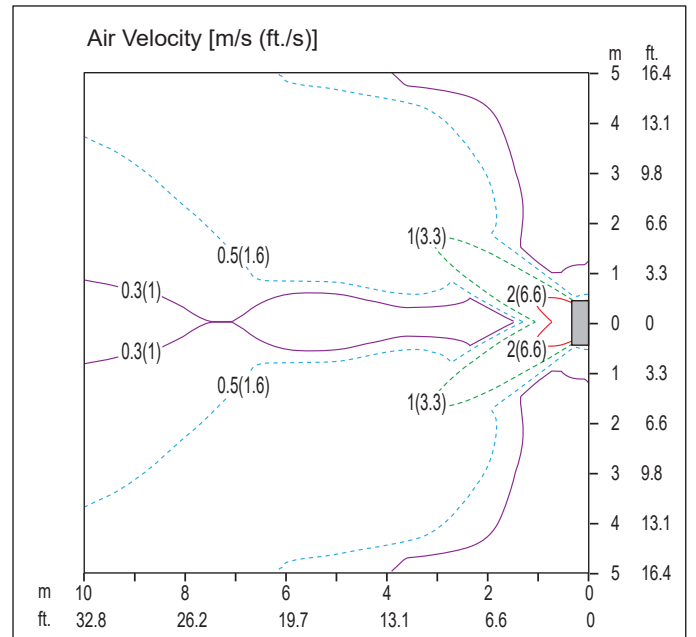

Top View

Discharge Angle : 35° (From the floor ▾)

Vertical Louver : Left & Right

Fan Speed : Power

AIR FLOW AND TEMPERATURE DISTRIBUTION

LSN120HXV2, continued.

Heating

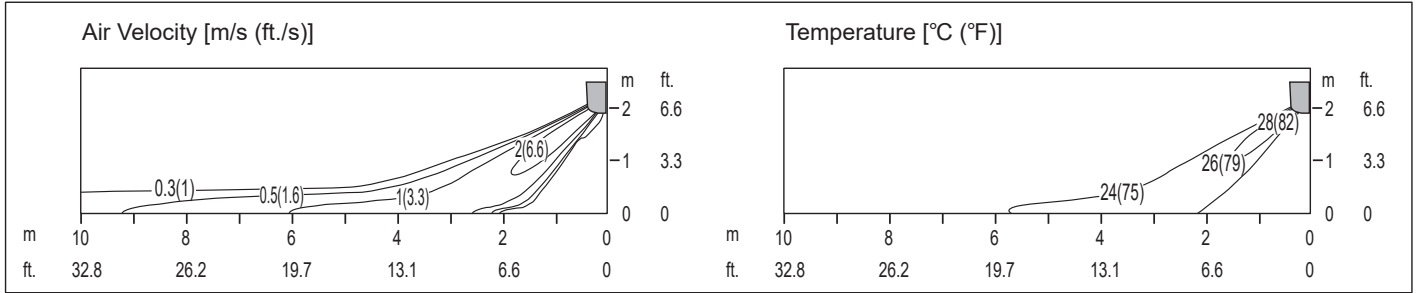

Side View

Discharge Angle : 55° (From the floor ▾)

Vertical Louver : Center

Fan Speed : Power

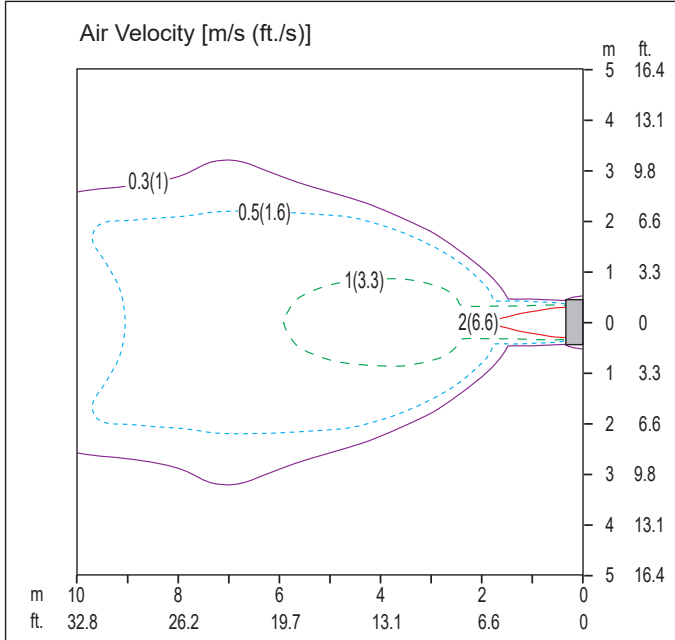

Top View

Discharge Angle : 55° (From the floor ▾)

Vertical Louver : Center

Fan Speed : Power

Air Speed 0.3 m/s (1 ft./s) Range : 10.5 m (34.4 ft.)

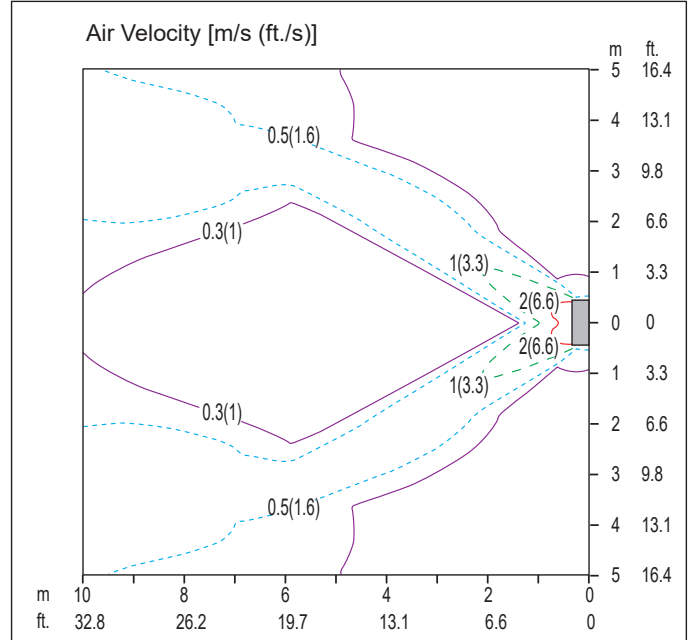

Top View

Discharge Angle : 55° (From the floor ▾)

Vertical Louver : Left & Right

Fan Speed : Power

ACCESSORIES

LG Monitoring View (LGMV) Diagnostic Software and Cable

LGMV software allows the service technician or commissioning agent to connect a computer USB port to the outdoor unit main printed circuit board (PCB) using an accessory cable without the need for a separate interface device. The main screen for LGMV allows user to view the following real time data on one screen:

- Actual inverter compressor speed
- Target inverter compressor speed
- Actual outdoor fan speed
- Target outdoor unit fan speed
- Actual superheat
- Target superheat
- Actual subcooler circuit superheat
- Target subcooler circuit superheat
- Main EEV position
- Subcooling EEV position
- Inverter compressor current transducer value
- Outdoor air temperature
- Actual high pressure/saturation temperature
- Actual low pressure/saturation temperature
- Suction temperature
- Inverter compressor discharge temperature
- Constant speed compressor discharge temperature
- Front outdoor coil pipe temperature
- Back outdoor coil pipe temperature
- Liquid line pipe temperature
- Subcooler inlet temperature
- Subcooler outlet temperature
- Average indoor unit (IDU) pipe temperature
- Inverter compressor operation indicator light
- Four-way reversing valve operation indicator light
- Pressure graph showing actual low pressure and actual high pressure levels
- Error code display
- Operating mode indicator
- Target high pressure
- Target low pressure
- PCB (printed circuit board) version
- Software version
- Installer name
- Model no. of outdoor units
- Site name
- Total number of connected indoor units
- Communication indicator lights
- Indoor unit capacity
- Indoor unit operating mode
- Indoor unit fan speed
- Indoor unit EEV position
- Indoor unit room temperature
- Indoor unit inlet pipe temperature
- Indoor unit outlet pipe temperature
- Indoor unit error code



Additional screens can be accessed by tabs on the main screen:

1. Cycleview: Graphic of internal components including:
 - Compressors showing actual speeds
 - EEVs
 - Indoor Units
 - Liquid injection valves
 - Temperature and pressure sensors
 - Four-way reversing valve
 - Outdoor fans showing status and speeds
2. Graph: Full screen graph of actual high and low pressures and high and low pressure limits. A sliding bar enables user to go back in time and view data.
3. Control IDU: Enables user to turn on all IDU's default setpoints of 86°F in heat mode or 64°F in cool mode.
4. Setting: Converts metric values to imperial values.
5. Making Data: Recording of real time data to a separate file created to be stored on the user's computer.
6. Loading Data: Recorded data from a saved ".CSV" file can be loaded to create an LGMV session.
7. Electrical Data: The lower half of main screen is changed to show the following:
 - Inverter compressor
 - Amps
 - Volts
 - Power Hz
 - Inverter control board fan Hz
 - Constant compressor
 - Current transducer value
 - Phase

Figure 28: Sample Cycleview.

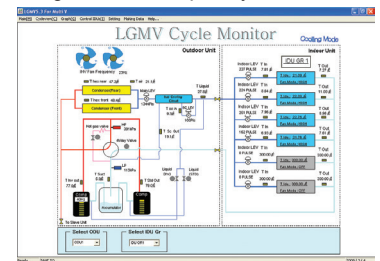

In lieu of connecting to the outdoor unit, user has the option to connect to the indoor unit with the use of a USB to RS-485 connector kit. When connected through the indoor unit, user will not be able to record data.

This software can be used to both commission new systems and troubleshoot existing systems. LGMV data can be recorded to a ".CSV" file and emailed to an LG representative to assist with diagnostic evaluations.

LGMV is available in different formats, including Mobile LGMV, which is a app for use on wireless devices. Contact your LG Sales Representative for information about the different formats, and recommended system requirements for any version of LGMV.

LG Smart Inverter Monitoring System (SIMS)

SIMS can be used to display and graph operational data for single zone systems and respective components (indoor unit and outdoor unit). SIMS also displays error codes and a troubleshooting guide. SIMS consists of a hardware Wireless Local Area Network (WLAN) module, an interface cable, and a free downloadable application (app) for iOS® or Android™. The user must supply either an Apple® or an Android smart phone; SIMS is not optimized for tablets, and only be used with LG single zone and Multi F systems.

Only trained HVAC service technicians familiar with variable refrigerant flow (VRF) systems in general and with LG's DFS products can use SIMS. The technician must understand inverter air conditioning operation cycles, the meaning of the data displayed by SIMS, and how to use the data to troubleshoot the system.

iOS is a registered trademark of Cisco in the U.S. and other countries. Android is a trademark of Google Inc. Apple is a trademark of Apple Inc., registered in the U.S. and other countries.

Contact your LG Sales Representative for system requirements, the latest version of SIMS, how to download the app, or other information.

Figure 29: LG SIMS WLAN Module.



PERFORMANCE DATA

[Cooling Capacity Data on page 51](#)

[Heating Capacity Data on page 54](#)

[Maximum Heating Capacity Data on page 56](#)

[Equipment Selection Procedure on page 59](#)

PERFORMANCE DATA

Cooling Capacity

LS090HEV2, LS120HEV2

Cooling Capacity Table for LS090HEV2 (LSU090HEV2 + LSN090HEV2)

Table 15: LSN090HEV2 / LSU120HEV2 Cooling Capacities.

Outdoor Air Temp. (°F DB)	Indoor Air Temperature (°F DB / °F WB)																				
	64 / 53			68 / 57			72 / 61			77 / 64			80 / 67			86 / 72			90 / 75		
	TC	SHC	PI	TC	SHC	PI	TC	SHC	PI	TC	SHC	PI	TC	SHC	PI	TC	SHC	PI	TC	SHC	PI
14	5.51	4.90	0.31	6.89	5.21	0.36	8.27	5.53	0.42	9.99	5.93	0.49	11.03	6.17	0.53	9.20	6.73	0.43	7.99	7.10	0.37
23	5.92	5.26	0.30	7.12	5.60	0.37	8.32	5.94	0.43	9.82	6.36	0.51	10.72	6.62	0.56	9.43	7.22	0.44	8.57	7.62	0.37
25	6.01	5.34	0.31	7.18	5.67	0.37	8.36	6.00	0.43	9.83	6.41	0.51	10.71	6.66	0.56	9.54	7.30	0.45	8.75	7.72	0.38
30	6.24	5.55	0.33	7.35	5.85	0.39	8.46	6.16	0.45	9.85	6.54	0.52	10.68	6.77	0.56	9.80	7.49	0.47	9.20	7.97	0.41
35	6.47	5.75	0.36	7.52	6.03	0.41	8.56	6.31	0.46	9.87	6.67	0.53	10.66	6.88	0.57	10.05	7.69	0.49	9.65	8.23	0.43
40	6.70	5.96	0.38	7.69	6.22	0.43	8.67	6.47	0.48	9.90	6.79	0.54	10.63	6.98	0.57	10.31	7.88	0.50	10.10	8.48	0.46
45	6.94	6.17	0.40	7.85	6.40	0.45	8.77	6.63	0.49	9.92	6.92	0.54	10.61	7.09	0.58	10.57	8.07	0.52	10.55	8.73	0.49
50	7.17	6.37	0.43	8.02	6.58	0.46	8.88	6.78	0.50	9.94	7.04	0.55	10.58	7.20	0.58	10.83	8.27	0.54	11.00	8.98	0.51
55	7.40	6.58	0.45	8.19	6.76	0.48	8.98	6.94	0.52	9.96	7.17	0.56	10.56	7.30	0.58	11.09	8.46	0.56	11.45	9.24	0.54
60	7.63	6.79	0.47	8.36	6.94	0.50	9.08	7.10	0.53	9.99	7.29	0.57	10.53	7.41	0.59	11.35	8.66	0.58	11.90	9.49	0.57
65	7.56	6.72	0.49	8.25	6.91	0.52	8.94	7.10	0.55	9.80	7.34	0.59	10.31	7.48	0.61	11.13	8.66	0.60	11.68	9.45	0.60
70	7.49	6.66	0.52	8.14	6.89	0.55	8.79	7.11	0.57	9.61	7.39	0.61	10.09	7.55	0.63	10.91	8.67	0.63	11.46	9.41	0.63
75	7.43	6.60	0.54	8.04	6.86	0.57	8.65	7.11	0.59	9.42	7.43	0.63	9.87	7.62	0.65	10.69	8.67	0.65	11.24	9.37	0.66
80	7.36	6.54	0.57	7.93	6.83	0.59	8.51	7.12	0.62	9.22	7.48	0.65	9.66	7.70	0.66	10.48	8.68	0.68	11.02	9.33	0.69
85	7.29	6.48	0.59	7.82	6.80	0.61	8.36	7.12	0.64	9.03	7.53	0.67	9.44	7.77	0.68	10.26	8.68	0.70	10.80	9.29	0.71
90	7.22	6.42	0.61	7.72	6.77	0.64	8.22	7.13	0.66	8.84	7.57	0.68	9.22	7.84	0.70	10.04	8.69	0.73	10.58	9.25	0.74
95	7.15	6.36	0.64	7.61	6.75	0.66	8.07	7.13	0.68	8.65	7.62	0.70	9.00	7.91	0.72	9.82	8.69	0.75	10.36	9.21	0.77
100	6.96	6.19	0.65	7.43	6.60	0.67	7.91	7.00	0.69	8.50	7.51	0.72	8.86	7.82	0.73	9.65	8.55	0.76	10.17	9.05	0.78
105	6.77	6.02	0.66	7.26	6.45	0.68	7.75	6.87	0.70	8.35	7.40	0.73	8.72	7.72	0.74	9.48	8.42	0.77	9.99	8.88	0.80
110	6.59	5.86	0.67	7.08	6.30	0.69	7.58	6.74	0.71	8.21	7.29	0.74	8.58	7.63	0.75	9.31	8.28	0.78	9.80	8.71	0.81
115	6.35	5.65	0.67	6.83	6.08	0.70	7.32	6.51	0.72	7.92	7.05	0.74	8.28	7.37	0.76	8.99	8.00	0.79	9.47	8.42	0.82
118	6.21	5.52	0.68	6.68	5.94	0.70	7.16	6.37	0.72	7.75	6.90	0.75	8.10	7.22	0.77	8.80	7.83	0.80	9.27	8.24	0.82
122	6.02	5.63	0.69	6.48	6.06	0.71	6.94	6.50	0.73	7.51	7.04	0.76	7.86	7.36	0.77	8.54	7.99	0.81	8.99	8.41	0.83

Performance Data

Cooling Capacity Table for LS120HEV2 (LSU120HEV2 + LSN120HEV2)

Table 16: LSN120HEV2 / LSU120HEV2 Cooling Capacities.

Outdoor Air Temp. (°F DB)	Indoor Air Temperature (°F DB / °F WB)																				
	64 / 53			68 / 57			72 / 61			77 / 64			80 / 67			86 / 72			90 / 75		
	TC	SHC	PI	TC	SHC	PI	TC	SHC	PI	TC	SHC	PI	TC	SHC	PI	TC	SHC	PI	TC	SHC	PI
14	7.35	5.65	0.49	9.19	6.02	0.58	11.03	6.39	0.67	13.33	6.84	0.78	14.71	7.12	0.84	12.27	7.76	0.69	10.65	8.19	0.58
23	7.89	6.07	0.48	9.49	6.46	0.58	11.09	6.86	0.68	13.09	7.35	0.81	14.29	7.64	0.88	12.58	8.34	0.70	11.43	8.80	0.58
25	8.01	6.17	0.49	9.58	6.55	0.59	11.14	6.93	0.69	13.10	7.40	0.81	14.28	7.69	0.89	12.71	8.42	0.71	11.67	8.91	0.60
30	8.32	6.40	0.53	9.80	6.76	0.62	11.28	7.11	0.71	13.13	7.55	0.82	14.24	7.81	0.89	13.06	8.65	0.74	12.27	9.21	0.64
35	8.63	6.64	0.57	10.03	6.97	0.65	11.42	7.29	0.73	13.16	7.69	0.84	14.21	7.94	0.90	13.41	8.87	0.77	12.87	9.50	0.69
40	8.94	6.88	0.60	10.25	7.18	0.68	11.56	7.47	0.75	13.19	7.84	0.85	14.18	8.06	0.91	13.75	9.10	0.80	13.47	9.79	0.73
45	9.25	7.12	0.64	10.47	7.38	0.71	11.70	7.65	0.78	13.22	7.98	0.86	14.14	8.18	0.91	14.10	9.32	0.83	14.07	10.08	0.77
50	9.56	7.36	0.67	10.70	7.59	0.74	11.83	7.83	0.80	13.25	8.13	0.87	14.11	8.31	0.92	14.44	9.54	0.86	14.67	10.37	0.82
55	9.87	7.60	0.71	10.92	7.80	0.76	11.97	8.01	0.82	13.29	8.27	0.89	14.07	8.43	0.93	14.79	9.77	0.89	15.27	10.66	0.86
60	10.18	7.83	0.75	11.14	8.01	0.79	12.11	8.19	0.84	13.32	8.42	0.90	14.04	8.55	0.93	15.14	9.99	0.91	15.87	10.95	0.90
65	10.09	7.76	0.78	11.00	7.98	0.83	11.92	8.20	0.87	13.06	8.47	0.93	13.75	8.64	0.96	14.84	10.00	0.95	15.57	10.91	0.95
70	9.99	7.69	0.82	10.86	7.95	0.87	11.72	8.21	0.91	12.81	8.53	0.96	13.46	8.72	0.99	14.55	10.00	0.99	15.28	10.86	0.99
75	9.90	7.62	0.86	10.72	7.92	0.90	11.53	8.21	0.94	12.55	8.58	0.99	13.17	8.80	1.02	14.26	10.01	1.03	14.99	10.82	1.04
80	9.81	7.55	0.90	10.57	7.88	0.94	11.34	8.22	0.98	12.30	8.63	1.02	12.87	8.88	1.05	13.97	10.02	1.07	14.70	10.77	1.09
85	9.71	7.48	0.94	10.43	7.85	0.97	11.15	8.22	1.01	12.05	8.69	1.06	12.58	8.97	1.08	13.67	10.02	1.11	14.40	10.72	1.13
90	9.62	7.41	0.97	10.29	7.82	1.01	10.96	8.23	1.04	11.79	8.74	1.09	12.29	9.05	1.11	13.38	10.03	1.15	14.11	10.68	1.18
95	9.53	7.34	1.01	10.15	7.79	1.04	10.76	8.23	1.08	11.54	8.80	1.12	12.00	9.13	1.14	13.09	10.03	1.19	13.82	10.63	1.23
100	9.28	7.14	1.03	9.91	7.61	1.06	10.55	8.08	1.09	11.34	8.67	1.13	11.81	9.02	1.16	12.86	9.87	1.21	13.57	10.44	1.24
105	9.03	6.95	1.04	9.68	7.44	1.08	10.33	7.93	1.11	11.14	8.55	1.15	11.63	8.91	1.18	12.64	9.71	1.23	13.31	10.25	1.26
110	8.78	6.76	1.06	9.45	7.27	1.09	10.11	7.78	1.13	10.94	8.42	1.17	11.44	8.80	1.19	12.41	9.55	1.24	13.06	10.06	1.28
115	8.47	6.52	1.07	9.11	7.02	1.10	9.75	7.51	1.14	10.56	8.13	1.18	11.04	8.51	1.21	11.99	9.23	1.26	12.62	9.72	1.29
118	8.28	6.37	1.08	8.91	6.86	1.11	9.54	7.35	1.15	10.33	7.96	1.19	10.80	8.33	1.21	11.74	9.04	1.27	12.36	9.51	1.30
122	8.03	6.50	1.09	8.64	7.00	1.12	9.25	7.50	1.16	10.02	8.12	1.20	10.48	8.50	1.23	11.38	9.22	1.28	11.99	9.70	1.32

DB: Dry Bulb Temperature (°F) WB: Wet Bulb Temperature (°F) TC: Total Capacity (kBtu/h)
 SHC: Sensible Capacity (kBtu/h) PI: Power Input (kW) (includes compressor, indoor fan motor and outdoor fan motor)

- All capacities are net, evaporator fan motor heat is deducted.
- Grey shading indicates reference data. When operating at this temperature, these values can be different if the system is not running consistently.

- Direct interpolation is permissible. ☹ Do not extrapolate.

Capacity as rated: 0 ft. above sea level with 24.6 ft. of refrigerant piping. 0 ft. level difference between outdoor and indoor units.

Cooling capacity rating obtained with air entering the indoor unit at 80°F dry bulb (DB) and 67°F wet bulb (WB), and outdoor ambient conditions of 95°F dry bulb (DB) and 75°F wet bulb (WB).



PERFORMANCE DATA

Cooling Capacity

LS180HEV2, LS240HEV2

Cooling Capacity Table for LS180HEV2 (LSU180HEV2 + LSN180HEV2)

Table 17: LSN0180HEV2 / LSU180HEV2 Cooling Capacities.

Outdoor Air Temp. (°F DB)	Indoor Air Temperature (°F DB / °F WB)																				
	64 / 53			68 / 57			72 / 61			77 / 64			80 / 67			86 / 72			90 / 75		
	TC	SHC	PI	TC	SHC	PI	TC	SHC	PI	TC	SHC	PI	TC	SHC	PI	TC	SHC	PI	TC	SHC	PI
14	11.02	8.76	0.64	13.78	9.32	0.76	16.54	9.89	0.87	19.99	10.60	1.02	22.06	11.03	1.11	18.41	12.03	0.90	15.97	12.69	0.77
23	11.83	9.40	0.63	14.23	10.01	0.76	16.63	10.62	0.89	19.64	11.38	1.06	21.44	11.84	1.16	18.86	12.91	0.92	17.15	13.63	0.77
25	12.02	9.55	0.65	14.37	10.14	0.78	16.72	10.73	0.91	19.65	11.47	1.07	21.42	11.91	1.16	19.07	13.05	0.94	17.51	13.81	0.79
30	12.48	9.92	0.70	14.70	10.47	0.82	16.92	11.01	0.93	19.70	11.69	1.08	21.37	12.10	1.17	19.59	13.40	0.98	18.41	14.26	0.85
35	12.95	10.29	0.74	15.04	10.79	0.85	17.13	11.29	0.96	19.75	11.92	1.10	21.31	12.29	1.18	20.11	13.74	1.01	19.31	14.71	0.90
40	13.41	10.66	0.79	15.37	11.12	0.89	17.34	11.57	0.99	19.79	12.14	1.12	21.26	12.49	1.19	20.63	14.09	1.05	20.21	15.16	0.96
45	13.87	11.03	0.84	15.71	11.44	0.93	17.54	11.85	1.02	19.84	12.37	1.13	21.21	12.68	1.20	21.15	14.44	1.09	21.10	15.61	1.02
50	14.34	11.40	0.89	16.04	11.76	0.97	17.75	12.13	1.05	19.88	12.59	1.15	21.16	12.87	1.21	21.67	14.79	1.13	22.00	16.06	1.07
55	14.80	11.77	0.93	16.38	12.09	1.00	17.96	12.41	1.08	19.93	12.82	1.16	21.11	13.06	1.22	22.19	15.13	1.16	22.90	16.51	1.13
60	15.27	12.13	0.98	16.72	12.41	1.04	18.16	12.69	1.10	19.97	13.04	1.18	21.06	13.25	1.23	22.70	15.48	1.20	23.80	16.97	1.18
65	15.13	12.02	1.03	16.50	12.36	1.09	17.88	12.70	1.15	19.59	13.12	1.22	20.62	13.38	1.27	22.27	15.49	1.25	23.36	16.90	1.25
70	14.99	11.92	1.08	16.29	12.31	1.14	17.59	12.71	1.19	19.21	13.21	1.26	20.19	13.51	1.31	21.83	15.50	1.31	22.92	16.82	1.31
75	14.85	11.81	1.13	16.07	12.26	1.18	17.30	12.72	1.24	18.83	13.29	1.30	19.75	13.63	1.34	21.39	15.51	1.36	22.48	16.75	1.37
80	14.71	11.70	1.18	15.86	12.21	1.23	17.01	12.73	1.28	18.45	13.37	1.34	19.31	13.76	1.38	20.95	15.52	1.41	22.04	16.68	1.43
85	14.57	11.59	1.23	15.65	12.16	1.28	16.72	12.74	1.33	18.07	13.46	1.39	18.87	13.89	1.42	20.51	15.52	1.46	21.60	16.61	1.49
90	14.43	11.48	1.28	15.43	12.11	1.32	16.43	12.75	1.37	17.69	13.54	1.43	18.44	14.02	1.46	20.07	15.53	1.51	21.16	16.54	1.55
95	14.29	11.37	1.33	15.22	12.06	1.37	16.15	12.76	1.41	17.31	13.62	1.47	18.00	14.15	1.50	19.63	15.54	1.57	20.72	16.47	1.61
100	13.92	11.07	1.35	14.87	11.80	1.39	15.82	12.52	1.44	17.01	13.43	1.49	17.72	13.98	1.52	19.30	15.29	1.59	20.35	16.17	1.63
105	13.55	10.77	1.37	14.52	11.53	1.41	15.49	12.29	1.46	16.71	13.24	1.51	17.44	13.81	1.55	18.96	15.05	1.61	19.97	15.87	1.66
110	13.17	10.47	1.39	14.17	11.26	1.43	15.17	12.05	1.48	16.41	13.04	1.53	17.16	13.64	1.57	18.62	14.80	1.63	19.60	15.58	1.68
115	12.70	10.10	1.41	13.67	10.87	1.45	14.63	11.64	1.49	15.84	12.60	1.55	16.56	13.18	1.58	17.99	14.30	1.65	18.94	15.05	1.70
118	12.42	9.87	1.41	13.37	10.63	1.46	14.31	11.39	1.50	15.49	12.33	1.56	16.20	12.90	1.59	17.60	14.00	1.67	18.54	14.74	1.71
122	12.05	10.07	1.43	12.96	10.84	1.47	13.88	11.61	1.52	15.03	12.58	1.58	15.71	13.16	1.61	17.08	14.28	1.68	17.98	15.03	1.73

Cooling Capacity Table for LS240HEV2 (LSU240HEV2 + LSN240HEV2)

Table 18: LSN240HEV2 / LSU240HEV2 Cooling Capacities.

Outdoor Air Temp. (°F DB)	Indoor Air Temperature (°F DB / °F WB)																				
	64 / 53			68 / 57			72 / 61			77 / 64			80 / 67			86 / 72			90 / 75		
	TC	SHC	PI	TC	SHC	PI	TC	SHC	PI	TC	SHC	PI	TC	SHC	PI	TC	SHC	PI	TC	SHC	PI
14	13.47	9.98	0.85	16.84	10.62	1.01	20.22	11.27	1.16	24.43	12.08	1.36	26.96	12.56	1.48	22.50	13.70	1.20	19.52	14.46	1.02
23	14.46	10.71	0.84	17.40	11.41	1.02	20.33	12.10	1.19	24.00	12.97	1.41	26.20	13.48	1.55	23.06	14.71	1.23	20.96	15.53	1.02
25	14.69	10.88	0.87	17.56	11.55	1.04	20.43	12.23	1.21	24.02	13.07	1.42	26.18	13.57	1.55	23.31	14.87	1.25	21.40	15.73	1.05
30	15.25	11.30	0.93	17.97	11.92	1.09	20.68	12.55	1.25	24.08	13.32	1.44	26.11	13.79	1.56	23.94	15.26	1.30	22.50	16.25	1.13
35	15.82	11.72	0.99	18.38	12.29	1.14	20.94	12.86	1.28	24.13	13.58	1.47	26.05	14.01	1.57	24.58	15.66	1.35	23.60	16.76	1.20
40	16.39	12.14	1.05	18.79	12.66	1.19	21.19	13.18	1.32	24.19	13.83	1.49	25.99	14.22	1.59	25.21	16.05	1.40	24.70	17.27	1.28
45	16.96	12.56	1.12	19.20	13.03	1.24	21.44	13.50	1.36	24.24	14.09	1.51	25.93	14.44	1.60	25.85	16.45	1.45	25.79	17.79	1.35
50	17.52	12.98	1.18	19.61	13.40	1.29	21.69	13.82	1.40	24.30	14.35	1.53	25.86	14.66	1.61	26.48	16.85	1.50	26.89	18.30	1.43
55	18.09	13.40	1.24	20.02	13.77	1.34	21.95	14.14	1.43	24.36	14.60	1.55	25.80	14.88	1.62	27.12	17.24	1.55	27.99	18.82	1.50
60	18.66	13.83	1.31	20.43	14.14	1.39	22.20	14.46	1.47	24.41	14.86	1.57	25.74	15.10	1.64	27.75	17.64	1.60	29.09	19.33	1.58
65	18.49	13.70	1.37	20.17	14.09	1.45	21.85	14.47	1.53	23.95	14.95	1.63	25.21	15.24	1.69	27.21	17.65	1.67	28.55	19.25	1.66
70	18.32	13.58	1.44	19.91	14.03	1.52	21.50	14.48	1.59	23.48	15.05	1.68	24.67	15.39	1.74	26.68	17.66	1.74	28.02	19.17	1.74
75	18.15	13.45	1.51	19.65	13.97	1.58	21.14	14.49	1.65	23.01	15.14	1.74	24.14	15.53	1.79	26.14	17.67	1.81	27.48	19.09	1.82
80	17.98	13.33	1.57	19.39	13.91	1.64	20.79	14.50	1.71	22.55	15.24	1.79	23.60	15.68	1.84	25.61	17.68	1.88	26.94	19.01	1.90
85	17.81	13.20	1.64	19.12	13.86	1.70	20.44	14.51	1.77	22.08	15.33	1.85	23.07	15.83	1.90	25.07	17.69	1.95	26.40	18.93	1.99
90	17.64	13.08	1.71	18.86	13.80	1.77	20.09	14.52	1.83	21.62	15.43	1.90	22.53	15.97	1.95	24.53	17.70	2.02	25.87	18.85	2.07
95	17.47	12.95	1.77	18.60	13.74	1.83	19.74	14.53	1.89	21.15	15.52	1.96	22.00	16.12	2.00	24.00	17.71	2.09	25.33	18.77	2.15
100	17.01	12.61	1.80	18.17	13.44	1.86	19.34	14.27	1.91	20.79	15.30	1.99	21.66	15.92	2.03	23.58	17.43	2.12	24.87	18.43	2.18
105	16.56	12.27	1.83	17.75	13.13	1.88	18.94	14.00	1.94	20.42	15.08	2.02	21.31	15.73	2.06	23.17	17.14	2.15	24.41	18.09	2.21
110	16.10	11.93	1.85	17.32	12.83	1.91	18.54	13.73	1.97	20.06	14.86	2.05	20.97	15.54	2.09	22.76	16.86	2.18	23.95	17.75	2.24
115	15.53	11.50	1.87	16.70	12.38	1.93	17.88	13.26	1.99	19.35	14.36	2.07	20.24	15.01	2.11	21.98	16.29	2.21	23.14	17.15	2.27
118	15.18	11.25	1.89	16.34	12.11	1.95	17.49	12.97	2.01	18.93	14.05	2.08	19.80	14.70	2.13	21.52	15.95	2.22	22.66	16.79	2.28
122	14.72	11.47	1.91	15.84	12.35	1.97	16.97	13.23	2.03	18.37	14.33	2.10	19.21	14.99	2.15	20.87	16.27	2.24	21.98	17.12	2.31

DB: Dry Bulb Temperature (°F) WB: Wet Bulb Temperature (°F) TC: Total Capacity (kBtu/h)
 SHC: Sensible Capacity (kBtu/h) PI: Power Input (kW) (includes compressor, indoor fan motor and outdoor fan motor)

- All capacities are net, evaporator fan motor heat is deducted.
- Grey shading indicates reference data. When operating at this temperature, these values can be different if the system is not running consistently.

3. Direct interpolation is permissible. ⚠ Do not extrapolate.

Capacity as rated: 0 ft. above sea level with 24.6 ft. of refrigerant piping. 0 ft. level difference between outdoor and indoor units.

Cooling capacity rating obtained with air entering the indoor unit at 80°F dry bulb (DB) and 67°F wet bulb (WB), and outdoor ambient conditions of 95°F dry bulb (DB) and 75°F wet bulb (WB).

PERFORMANCE DATA

Cooling Capacity

LS090HXV2, LS120HXV2

Cooling Capacity Table for LS090HXV2 (LSU090HXV2 + LSN090HXV2)

Table 19: LSN090HXV2 / LSU090HXV2 Cooling Capacities.

Outdoor Air Temp. (°F DB)	Indoor Air Temperature (°F DB / °F WB)																				
	64 / 53			68 / 57			72 / 61			77 / 64			80 / 67			86 / 72			90 / 75		
	TC	SHC	PI	TC	SHC	PI	TC	SHC	PI	TC	SHC	PI	TC	SHC	PI	TC	SHC	PI	TC	SHC	PI
14	5.51	4.90	0.31	6.89	5.21	0.37	8.27	5.53	0.43	9.99	5.93	0.50	11.03	6.17	0.54	9.20	6.72	0.44	7.99	7.10	0.37
23	5.92	5.26	0.31	7.12	5.60	0.37	8.32	5.94	0.44	9.82	6.36	0.52	10.72	6.62	0.57	9.43	7.22	0.45	8.57	7.62	0.37
25	6.01	5.34	0.32	7.18	5.67	0.38	8.36	6.00	0.44	9.83	6.41	0.52	10.71	6.66	0.57	9.54	7.30	0.46	8.75	7.72	0.39
30	6.24	5.55	0.34	7.35	5.85	0.40	8.46	6.16	0.46	9.85	6.54	0.53	10.68	6.77	0.57	9.80	7.49	0.48	9.20	7.97	0.41
35	6.47	5.75	0.36	7.52	6.03	0.42	8.56	6.31	0.47	9.87	6.66	0.54	10.66	6.87	0.58	10.05	7.69	0.49	9.65	8.23	0.44
40	6.70	5.96	0.39	7.69	6.22	0.43	8.67	6.47	0.48	9.90	6.79	0.54	10.63	6.98	0.58	10.31	7.88	0.51	10.10	8.48	0.47
45	6.94	6.17	0.41	7.85	6.40	0.45	8.77	6.63	0.50	9.92	6.92	0.55	10.61	7.09	0.59	10.57	8.07	0.53	10.55	8.73	0.50
50	7.17	6.37	0.43	8.02	6.58	0.47	8.88	6.78	0.51	9.94	7.04	0.56	10.58	7.19	0.59	10.83	8.27	0.55	11.00	8.98	0.52
55	7.40	6.58	0.46	8.19	6.76	0.49	8.98	6.94	0.52	9.96	7.17	0.57	10.56	7.30	0.59	11.09	8.46	0.57	11.45	9.23	0.55
60	7.63	6.79	0.48	8.36	6.94	0.51	9.08	7.10	0.54	9.99	7.29	0.58	10.53	7.41	0.60	11.35	8.66	0.59	11.90	9.49	0.58
65	7.56	6.72	0.50	8.25	6.91	0.53	8.94	7.10	0.56	9.80	7.34	0.60	10.31	7.48	0.62	11.13	8.66	0.61	11.68	9.45	0.61
70	7.49	6.66	0.53	8.14	6.88	0.55	8.79	7.11	0.58	9.61	7.39	0.62	10.09	7.55	0.64	10.91	8.67	0.64	11.46	9.41	0.64
75	7.43	6.60	0.55	8.04	6.86	0.58	8.65	7.11	0.60	9.42	7.43	0.64	9.87	7.62	0.66	10.69	8.67	0.66	11.24	9.37	0.67
80	7.36	6.54	0.58	7.93	6.83	0.60	8.51	7.12	0.63	9.22	7.48	0.66	9.66	7.70	0.67	10.48	8.68	0.69	11.02	9.33	0.70
85	7.29	6.48	0.60	7.82	6.80	0.62	8.36	7.12	0.65	9.03	7.53	0.68	9.44	7.77	0.69	10.26	8.68	0.71	10.80	9.29	0.73
90	7.22	6.42	0.62	7.72	6.77	0.65	8.22	7.13	0.67	8.84	7.57	0.70	9.22	7.84	0.71	10.04	8.69	0.74	10.58	9.25	0.76
95	7.15	6.36	0.65	7.61	6.74	0.67	8.07	7.13	0.69	8.65	7.62	0.72	9.00	7.91	0.73	9.82	8.69	0.76	10.36	9.21	0.79
100	6.96	6.19	0.66	7.43	6.60	0.68	7.91	7.00	0.70	8.50	7.51	0.73	8.86	7.82	0.74	9.65	8.55	0.78	10.17	9.04	0.80
105	6.77	6.02	0.67	7.26	6.45	0.69	7.75	6.87	0.71	8.35	7.40	0.74	8.72	7.72	0.75	9.48	8.41	0.79	9.99	8.88	0.81
110	6.59	5.85	0.68	7.08	6.30	0.70	7.58	6.74	0.72	8.21	7.29	0.75	8.58	7.63	0.77	9.31	8.28	0.80	9.80	8.71	0.82
115	6.35	5.65	0.69	6.83	6.08	0.71	7.32	6.51	0.73	7.92	7.05	0.76	8.28	7.37	0.77	8.99	8.00	0.81	9.47	8.42	0.83
118	6.21	5.52	0.69	6.68	5.94	0.71	7.16	6.37	0.73	7.75	6.90	0.76	8.10	7.21	0.78	8.80	7.83	0.81	9.27	8.24	0.84
122	6.02	5.63	0.70	6.48	6.06	0.72	6.94	6.49	0.74	7.51	7.03	0.77	7.86	7.36	0.79	8.54	7.99	0.82	8.99	8.40	0.84

Performance Data

Cooling Capacity Table for LS120HXV2 (LSU120HXV2 + LSN120HXV2)

Table 20: LSN120HXV2 / LSU120HXV2 Cooling Capacities.

Outdoor Air Temp. (°F DB)	Indoor Air Temperature (°F DB / °F WB)																				
	64 / 53			68 / 57			72 / 61			77 / 64			80 / 67			86 / 72			90 / 75		
	TC	SHC	PI	TC	SHC	PI	TC	SHC	PI	TC	SHC	PI	TC	SHC	PI	TC	SHC	PI	TC	SHC	PI
14	7.35	5.65	0.49	9.19	6.02	0.58	11.03	6.39	0.67	13.33	6.84	0.78	14.71	7.12	0.84	12.27	7.76	0.69	10.65	8.19	0.58
23	7.89	6.07	0.48	9.49	6.46	0.58	11.09	6.86	0.68	13.09	7.35	0.81	14.29	7.64	0.88	12.58	8.34	0.70	11.43	8.80	0.58
25	8.01	6.17	0.49	9.58	6.55	0.59	11.14	6.93	0.69	13.10	7.40	0.81	14.28	7.69	0.89	12.71	8.42	0.71	11.67	8.91	0.60
30	8.32	6.40	0.53	9.80	6.76	0.62	11.28	7.11	0.71	13.13	7.55	0.82	14.24	7.81	0.89	13.06	8.65	0.74	12.27	9.21	0.64
35	8.63	6.64	0.57	10.03	6.97	0.65	11.42	7.29	0.73	13.16	7.69	0.84	14.21	7.94	0.90	13.41	8.87	0.77	12.87	9.50	0.69
40	8.94	6.88	0.60	10.25	7.18	0.68	11.56	7.47	0.75	13.19	7.84	0.85	14.18	8.06	0.91	13.75	9.10	0.80	13.47	9.79	0.73
45	9.25	7.12	0.64	10.47	7.38	0.71	11.70	7.65	0.78	13.22	7.98	0.86	14.14	8.18	0.91	14.10	9.32	0.83	14.07	10.08	0.77
50	9.56	7.36	0.67	10.70	7.59	0.74	11.83	7.83	0.80	13.25	8.13	0.87	14.11	8.31	0.92	14.44	9.54	0.86	14.67	10.37	0.82
55	9.87	7.60	0.71	10.92	7.80	0.76	11.97	8.01	0.82	13.29	8.27	0.89	14.07	8.43	0.93	14.79	9.77	0.89	15.27	10.66	0.86
60	10.18	7.83	0.75	11.14	8.01	0.79	12.11	8.19	0.84	13.32	8.42	0.90	14.04	8.55	0.93	15.14	9.99	0.91	15.87	10.95	0.90
65	10.09	7.76	0.78	11.00	7.98	0.83	11.92	8.20	0.87	13.06	8.47	0.93	13.75	8.64	0.96	14.84	10.00	0.95	15.57	10.91	0.95
70	9.99	7.69	0.82	10.86	7.95	0.87	11.72	8.21	0.91	12.81	8.53	0.96	13.46	8.72	0.99	14.55	10.00	0.99	15.28	10.86	0.99
75	9.90	7.62	0.86	10.72	7.92	0.90	11.53	8.21	0.94	12.55	8.58	0.99	13.17	8.80	1.02	14.26	10.01	1.03	14.99	10.82	1.04
80	9.81	7.55	0.90	10.57	7.88	0.94	11.34	8.22	0.98	12.30	8.63	1.02	12.87	8.88	1.05	13.97	10.02	1.07	14.70	10.77	1.09
85	9.71	7.48	0.94	10.43	7.85	0.97	11.15	8.22	1.01	12.05	8.69	1.06	12.58	8.97	1.08	13.67	10.02	1.11	14.40	10.72	1.13
90	9.62	7.41	0.97	10.29	7.82	1.01	10.96	8.23	1.04	11.79	8.74	1.09	12.29	9.05	1.11	13.38	10.03	1.15	14.11	10.68	1.18
95	9.53	7.34	1.01	10.15	7.79	1.04	10.76	8.23	1.08	11.54	8.80	1.12	12.00	9.13	1.14	13.09	10.03	1.19	13.82	10.63	1.23
100	9.28	7.14	1.03	9.91	7.61	1.06	10.55	8.08	1.09	11.34	8.67	1.13	11.81	9.02	1.16	12.86	9.87	1.21	13.57	10.44	1.24
105	9.03	6.95	1.04	9.68	7.44	1.08	10.33	7.93	1.11	11.14	8.55	1.15	11.63	8.91	1.18	12.64	9.71	1.23	13.31	10.25	1.26
110	8.78	6.76	1.06	9.45	7.27	1.09	10.11	7.78	1.13	10.94	8.42	1.17	11.44	8.80	1.19	12.41	9.55	1.24	13.06	10.06	1.28
115	8.47	6.52	1.07	9.11	7.02	1.10	9.75	7.51	1.14	10.56	8.13	1.18	11.04	8.51	1.21	11.99	9.23	1.26	12.62	9.72	1.29
118	8.28	6.37	1.08	8.91	6.86	1.11	9.54	7.35	1.15	10.33	7.96	1.19	10.80	8.33	1.21	11.74	9.04	1.27	12.36	9.51	1.30
122	8.03	6.50	1.09	8.64	7.00	1.12	9.25	7.50	1.16	10.02	8.12	1.20	10.48	8.50	1.23	11.38	9.22	1.28	11.99	9.70	1.32

DB: Dry Bulb Temperature (°F) WB: Wet Bulb Temperature (°F) TC: Total Capacity (kBtu/h)
 SHC: Sensible Capacity (kBtu/h) PI: Power Input (kW) (includes compressor, indoor fan motor and outdoor fan motor)
 1. All capacities are net, evaporator fan motor heat is deducted.
 2. Grey shading indicates reference data. When operating at this temperature, these values can be different if the system is not running consistently.

3. Direct interpolation is permissible. ⚠ Do not extrapolate.
 Capacity as rated: 0 ft. above sea level with 24.6 ft. of refrigerant piping. 0 ft. level difference between outdoor and indoor units.
 Cooling capacity rating obtained with air entering the indoor unit at 80°F dry bulb (DB) and 67°F wet bulb (WB), and outdoor ambient conditions of 95°F dry bulb (DB) and 75°F wet bulb (WB).



PERFORMANCE DATA

Heating Capacity

LS090HEV2, LS120HEV2, LS180HEV2

Heating Capacity Table for LS090HEV2 (LSU090HEV2 + LSN090HEV2)

Table 21: LSN090HEV2 / LSU090HEV2 Heating Capacities.

Outdoor Air Temp.		Indoor Air Temperature (°F DB)													
°F DB	°F WB	60		64		68		70		72		75		86	
		TC	PI	TC	PI	TC	PI	TC	PI	TC	PI	TC	PI	TC	PI
16	14	6.90	0.70	6.69	0.69	6.62	0.69	6.55	0.68	6.50	0.68	6.37	0.68	6.22	0.68
17	15	6.94	0.71	6.73	0.70	6.67	0.70	6.60	0.69	6.55	0.69	6.42	0.68	6.26	0.68
19	17	7.04	0.72	6.82	0.71	6.76	0.71	6.69	0.71	6.64	0.71	6.50	0.70	6.35	0.70
24	23	7.72	0.75	7.49	0.74	7.41	0.74	7.34	0.73	7.28	0.73	7.13	0.72	6.96	0.72
32	30	9.25	0.81	8.97	0.80	8.88	0.80	8.79	0.79	8.73	0.79	8.55	0.78	8.35	0.78
41	38	10.62	0.86	10.30	0.85	10.19	0.85	10.09	0.84	10.01	0.84	9.81	0.83	9.58	0.83
43	40	10.96	0.87	10.63	0.86	10.52	0.86	10.41	0.86	10.33	0.86	10.13	0.85	9.89	0.85
47	43	11.47	0.89	11.12	0.88	11.01	0.88	10.90	0.88	10.82	0.88	10.60	0.87	10.35	0.87
53	50	11.58	0.90	11.23	0.89	11.12	0.89	11.01	0.88	10.92	0.88	10.71	0.87	10.45	0.87
59	53	11.85	0.91	11.49	0.90	11.37	0.90	11.26	0.89	11.17	0.89	10.95	0.88	10.69	0.88
64	57	12.10	0.93	11.73	0.92	11.61	0.92	11.50	0.91	11.41	0.91	11.18	0.90	10.92	0.90
70	61	12.33	0.94	11.96	0.93	11.83	0.93	11.72	0.92	11.63	0.92	11.39	0.91	11.12	0.91
75	65	12.50	0.95	12.12	0.95	12.00	0.95	11.88	0.94	11.79	0.94	11.55	0.93	11.28	0.93

Heating Capacity Table for LS120HEV2 (LSU120HEV2 + LSN120HEV2)

Table 22: LSN120HEV2 / LSU120HEV2 Heating Capacities.

Outdoor Air Temp.		Indoor Air Temperature (°F DB)													
°F DB	°F WB	60		64		68		70		72		75		86	
		TC	PI	TC	PI	TC	PI	TC	PI	TC	PI	TC	PI	TC	PI
16	14	7.59	0.80	7.36	0.79	7.29	0.79	7.22	0.78	7.16	0.78	7.02	0.77	6.85	0.77
17	15	7.65	0.81	7.41	0.80	7.34	0.80	7.27	0.79	7.21	0.79	7.07	0.78	6.90	0.78
19	17	7.75	0.82	7.51	0.81	7.44	0.81	7.36	0.81	7.31	0.81	7.16	0.80	6.99	0.80
24	23	8.50	0.85	8.24	0.84	8.16	0.84	8.08	0.84	8.02	0.84	7.85	0.83	7.67	0.83
32	30	10.19	0.92	9.88	0.91	9.78	0.91	9.68	0.90	9.61	0.90	9.41	0.89	9.19	0.89
41	38	11.69	0.98	11.33	0.97	11.22	0.97	11.11	0.96	11.02	0.96	10.80	0.95	10.55	0.95
43	40	12.06	1.00	11.70	0.99	11.58	0.99	11.47	0.98	11.38	0.98	11.15	0.97	10.88	0.97
47	43	12.63	1.02	12.24	1.01	12.12	1.01	12.00	1.00	11.91	1.00	11.67	0.99	11.39	0.99
53	50	12.75	1.03	12.37	1.02	12.24	1.02	12.12	1.01	12.03	1.01	11.79	1.00	11.51	1.00
59	53	13.04	1.04	12.65	1.03	12.52	1.03	12.40	1.02	12.30	1.02	12.05	1.01	11.77	1.01
64	57	13.32	1.06	12.92	1.05	12.79	1.05	12.66	1.04	12.56	1.04	12.31	1.03	12.02	1.03
70	61	13.57	1.08	13.16	1.07	13.03	1.07	12.90	1.06	12.80	1.06	12.54	1.04	12.25	1.04
75	65	13.76	1.09	13.35	1.08	13.21	1.08	13.08	1.07	12.98	1.07	12.72	1.06	12.42	1.06

Heating Capacity Table for LS180HEV2 (LSU180HEV2 + LSN180HEV2)

Table 23: LSN180HEV2 / LSU180HEV2 Heating Capacities.

Outdoor Air Temp.		Indoor Air Temperature (°F DB)													
°F DB	°F WB	60		64		68		70		72		75		86	
		TC	PI	TC	PI	TC	PI	TC	PI	TC	PI	TC	PI	TC	PI
16	14	12.02	1.26	11.66	1.25	11.54	1.25	11.43	1.24	11.34	1.24	11.11	1.23	10.85	1.23
17	15	12.10	1.28	11.74	1.26	11.62	1.26	11.50	1.25	11.42	1.25	11.19	1.24	10.92	1.24
19	17	12.27	1.30	11.90	1.29	11.78	1.29	11.66	1.28	11.57	1.28	11.34	1.26	11.07	1.26
24	23	13.46	1.35	13.05	1.34	12.92	1.34	12.79	1.32	12.69	1.32	12.44	1.31	12.14	1.31
32	30	16.13	1.46	15.64	1.44	15.48	1.44	15.33	1.43	15.21	1.43	14.91	1.42	14.55	1.42
41	38	18.51	1.55	17.95	1.54	17.76	1.54	17.59	1.52	17.45	1.52	17.10	1.51	16.70	1.51
43	40	19.10	1.58	18.52	1.56	18.33	1.56	18.15	1.55	18.01	1.55	17.65	1.53	17.23	1.53
47	43	19.99	1.61	19.39	1.60	19.19	1.60	19.00	1.58	18.85	1.58	18.48	1.57	18.04	1.57
53	50	20.19	1.63	19.58	1.61	19.38	1.61	19.19	1.60	19.04	1.60	18.66	1.58	18.22	1.58
59	53	20.65	1.65	20.03	1.63	19.82	1.63	19.63	1.61	19.48	1.61	19.09	1.60	18.63	1.60
64	57	21.09	1.68	20.45	1.66	20.25	1.66	20.05	1.65	19.89	1.65	19.49	1.63	19.03	1.63
70	61	21.49	1.70	20.84	1.69	20.63	1.69	20.43	1.67	20.27	1.67	19.86	1.65	19.39	1.65
75	65	21.79	1.73	21.13	1.71	20.92	1.71	20.71	1.69	20.55	1.69	20.14	1.68	19.66	1.68

DB: Dry Bulb Temperature (°F) WB: Wet Bulb Temperature (°F) TC: Total Capacity (kBtu/h)

PI: Power Input (kW) (includes compressor, indoor fan motor and outdoor fan motor)

1. All capacities are net, evaporator fan motor heat is deducted.

2. Direct interpolation is permissible. ⚠ Do not extrapolate.

Capacity as rated: 0 ft. above sea level with 24.6 ft. of refrigerant piping. 0 ft. level difference between outdoor and indoor units.

Heating capacity rating obtained with air entering the indoor unit at 70°F dry bulb (DB) and 60°F wet bulb (WB), and outdoor ambient conditions of 47°F dry bulb (DB) and 43°F wet bulb (WB).

PERFORMANCE DATA

Heating Capacity

LS240HEV2, LS090HXV2, LS120HXV2

Heating Capacity Table for LS240HEV2 (LSU240HEV2 + LSN240HEV2)

Table 24: LSN240HEV2 / LSU240HEV2 Heating Capacities.

Outdoor Air Temp.		Indoor Air Temperature (°F DB)													
°F DB	°F WB	60		64		68		70		72		75		86	
		TC	PI	TC	PI	TC	PI	TC	PI	TC	PI	TC	PI	TC	PI
16	14	13.92	1.54	13.50	1.53	13.36	1.53	13.23	1.51	13.13	1.51	12.87	1.50	12.56	1.50
17	15	14.02	1.56	13.59	1.54	13.45	1.54	13.32	1.53	13.22	1.53	12.95	1.51	12.64	1.51
19	17	14.21	1.59	13.77	1.57	13.64	1.57	13.50	1.56	13.40	1.56	13.13	1.54	12.82	1.54
24	23	15.58	1.65	15.11	1.63	14.96	1.63	14.81	1.61	14.69	1.61	14.40	1.60	14.06	1.60
32	30	18.68	1.78	18.11	1.76	17.93	1.76	17.75	1.74	17.61	1.74	17.26	1.73	16.85	1.73
41	38	21.43	1.90	20.78	1.88	20.57	1.88	20.37	1.86	20.21	1.86	19.80	1.84	19.33	1.84
43	40	22.12	1.92	21.45	1.91	21.23	1.91	21.02	1.89	20.86	1.89	20.44	1.87	19.95	1.87
47	43	23.15	1.97	22.45	1.95	22.22	1.95	22.00	1.93	21.83	1.93	21.39	1.91	20.88	1.91
53	50	23.38	1.99	22.67	1.97	22.44	1.97	22.22	1.95	22.05	1.95	21.61	1.93	21.09	1.93
59	53	23.91	2.01	23.19	1.99	22.95	1.99	22.73	1.97	22.55	1.97	22.10	1.95	21.57	1.95
64	57	24.42	2.05	23.68	2.03	23.44	2.03	23.21	2.01	23.03	2.01	22.57	1.99	22.03	1.99
70	61	24.89	2.08	24.13	2.06	23.89	2.06	23.65	2.04	23.47	2.04	23.00	2.02	22.45	2.02
75	65	25.23	2.11	24.47	2.09	24.22	2.09	23.98	2.07	23.80	2.07	23.32	2.04	22.76	2.04

Heating Capacity Table for LS090HXV2 (LSU090HXV2 + LSN090HXV2)

Table 25: LSN090HXV2 / LSU090HXV2 Heating Capacities.

Outdoor Air Temp.		Indoor Air Temperature (°F DB)													
°F DB	°F WB	60		64		68		70		72		75		86	
		TC	PI	TC	PI	TC	PI	TC	PI	TC	PI	TC	PI	TC	PI
16	14	6.90	0.70	6.69	0.69	6.62	0.69	6.55	0.68	6.50	0.68	6.37	0.68	6.22	0.68
17	15	6.94	0.71	6.73	0.70	6.67	0.70	6.60	0.69	6.55	0.69	6.42	0.68	6.26	0.68
19	17	7.04	0.72	6.82	0.71	6.76	0.71	6.69	0.71	6.64	0.71	6.50	0.70	6.35	0.70
24	23	7.72	0.75	7.49	0.74	7.41	0.74	7.34	0.73	7.28	0.73	7.13	0.72	6.96	0.72
32	30	9.25	0.81	8.97	0.80	8.88	0.80	8.79	0.79	8.73	0.79	8.55	0.78	8.35	0.78
41	38	10.62	0.86	10.30	0.85	10.19	0.85	10.09	0.84	10.01	0.84	9.81	0.83	9.58	0.83
43	40	10.96	0.87	10.63	0.86	10.52	0.86	10.41	0.86	10.33	0.86	10.13	0.85	9.89	0.85
47	43	11.47	0.89	11.12	0.88	11.01	0.88	10.90	0.88	10.82	0.88	10.60	0.87	10.35	0.87
53	50	11.58	0.90	11.23	0.89	11.12	0.89	11.01	0.88	10.92	0.88	10.71	0.87	10.45	0.87
59	53	11.85	0.91	11.49	0.90	11.37	0.90	11.26	0.89	11.17	0.89	10.95	0.88	10.69	0.88
64	57	12.10	0.93	11.73	0.92	11.61	0.92	11.50	0.91	11.41	0.91	11.18	0.90	10.92	0.90
70	61	12.33	0.94	11.96	0.93	11.83	0.93	11.72	0.92	11.63	0.92	11.39	0.91	11.12	0.91
75	65	12.50	0.95	12.12	0.95	12.00	0.95	11.88	0.94	11.79	0.94	11.55	0.93	11.28	0.93

Heating Capacity Table for LS120HXV2 (LSU120HXV2 + LSN120HXV2)

Table 26: LSN120HXV2 / LSU120HXV2 Heating Capacities.

Outdoor Air Temp.		Indoor Air Temperature (°F DB)													
°F DB	°F WB	60		64		68		70		72		75		86	
		TC	PI	TC	PI	TC	PI	TC	PI	TC	PI	TC	PI	TC	PI
16	14	7.59	0.80	7.36	0.79	7.29	0.79	7.22	0.78	7.16	0.78	7.02	0.77	6.85	0.77
17	15	7.65	0.81	7.41	0.80	7.34	0.80	7.27	0.79	7.21	0.79	7.07	0.78	6.90	0.78
19	17	7.75	0.82	7.51	0.81	7.44	0.81	7.36	0.81	7.31	0.81	7.16	0.80	6.99	0.80
24	23	8.50	0.85	8.24	0.84	8.16	0.84	8.08	0.84	8.02	0.84	7.85	0.83	7.67	0.83
32	30	10.19	0.92	9.88	0.91	9.78	0.91	9.68	0.90	9.61	0.90	9.41	0.89	9.19	0.89
41	38	11.69	0.98	11.33	0.97	11.22	0.97	11.11	0.96	11.02	0.96	10.80	0.95	10.55	0.95
43	40	12.06	1.00	11.70	0.99	11.58	0.99	11.47	0.98	11.38	0.98	11.15	0.97	10.88	0.97
47	43	12.63	1.02	12.24	1.01	12.12	1.01	12.00	1.00	11.91	1.00	11.67	0.99	11.39	0.99
53	50	12.75	1.03	12.37	1.02	12.24	1.02	12.12	1.01	12.03	1.01	11.79	1.00	11.51	1.00
59	53	13.04	1.04	12.65	1.03	12.52	1.03	12.40	1.02	12.30	1.02	12.05	1.01	11.77	1.01
64	57	13.32	1.06	12.92	1.05	12.79	1.05	12.66	1.04	12.56	1.04	12.31	1.03	12.02	1.03
70	61	13.57	1.08	13.16	1.07	13.03	1.07	12.90	1.06	12.80	1.06	12.54	1.04	12.25	1.04
75	65	13.76	1.09	13.35	1.08	13.21	1.08	13.08	1.07	12.98	1.07	12.72	1.06	12.42	1.06

DB: Dry Bulb Temperature (°F) WB: Wet Bulb Temperature (°F) TC: Total Capacity (kBtu/h)

PI: Power Input (kW) (includes compressor, indoor fan motor and outdoor fan motor)

1. All capacities are net, evaporator fan motor heat is deducted.

2. Direct interpolation is permissible. ⚠ Do not extrapolate.

Capacity as rated: 0 ft. above sea level with 24.6 ft. of refrigerant piping. 0 ft. level difference between outdoor and indoor units.

Heating capacity rating obtained with air entering the indoor unit at 70°F dry bulb (DB) and 60°F wet bulb (WB), and outdoor ambient conditions of 47°F dry bulb (DB) and 43°F wet bulb (WB).



PERFORMANCE DATA

Maximum Heating Capacity

LS090HEV2, LS120HEV2

Maximum Heating Capacity Table for LS090HEV2 (LSU090HEV2 + LSN090HEV2)

Table 27: LSN090HEV2 / LSU090HEV2 Heating Capacities.

Outdoor Air Temp.		Indoor Air Temperature (°F DB)													
°F DB	°F WB	60		64		68		70		72		75		86	
		TC	PI	TC	PI	TC	PI	TC	PI	TC	PI	TC	PI	TC	PI
16	14	8.37	1.15	8.25	1.17	8.13	1.18	8.08	1.19	7.84	1.17	7.51	1.15	6.22	1.06
17	15	8.68	1.16	8.56	1.18	8.44	1.19	8.39	1.20	8.14	1.18	7.80	1.14	6.44	1.01
19	17	9.17	1.16	9.05	1.18	8.92	1.19	8.76	1.20	8.58	1.17	8.19	1.13	6.68	0.99
24	23	10.07	1.17	9.93	1.18	9.80	1.18	9.74	1.18	9.36	1.15	8.83	1.11	6.89	0.95
32	30	10.97	1.13	10.84	1.14	10.70	1.14	10.64	1.14	10.13	1.10	9.43	1.05	6.95	0.86
41	38	11.84	1.05	11.70	1.07	11.55	1.10	11.49	1.11	10.90	1.05	10.09	0.99	7.33	0.73
43	40	12.20	1.01	12.05	1.03	11.91	1.05	11.84	1.06	11.22	1.01	10.37	0.93	7.47	0.67
47	43	12.93	0.97	12.78	1.00	12.63	1.04	12.52	1.05	11.90	0.99	10.99	0.91	7.90	0.63
53	50	12.74	0.94	12.58	0.97	12.42	1.01	12.45	1.02	11.61	0.96	10.61	0.86	7.29	0.53
59	53	12.59	0.92	12.58	0.96	12.57	1.00	12.46	1.02	11.77	0.95	10.68	0.86	7.19	0.54
64	57	12.81	0.90	12.62	0.91	12.42	0.93	12.33	0.94	11.57	0.88	10.53	0.80	7.11	0.52
70	61	12.86	0.85	12.63	0.85	12.40	0.85	12.30	0.85	11.55	0.80	10.52	0.73	7.14	0.47
75	65	13.05	0.77	12.78	0.79	12.51	0.82	12.28	0.83	11.62	0.78	10.58	0.70	7.08	0.43

Maximum Heating Capacity Table for LS120HEV2 (LSU120HEV2 + LSN120HEV2)

Table 28: LSN120HEV2 / LSU120HEV2 Heating Capacities.

Outdoor Air Temp.		Indoor Air Temperature (°F DB)													
°F DB	°F WB	60		64		68		70		72		75		86	
		TC	PI	TC	PI	TC	PI	TC	PI	TC	PI	TC	PI	TC	PI
16	14	9.21	1.31	9.08	1.33	8.95	1.35	8.89	1.36	8.63	1.34	8.27	1.31	6.85	1.21
17	15	9.56	1.33	9.43	1.35	9.29	1.36	9.23	1.37	8.96	1.34	8.59	1.30	7.09	1.15
19	17	10.10	1.33	9.96	1.35	9.82	1.36	9.64	1.37	9.45	1.34	9.02	1.29	7.35	1.14
24	23	11.08	1.34	10.94	1.34	10.79	1.35	10.73	1.35	10.30	1.31	9.72	1.27	7.58	1.09
32	30	12.08	1.30	11.93	1.30	11.78	1.30	11.71	1.30	11.15	1.26	10.38	1.20	7.65	0.99
41	38	13.03	1.20	12.88	1.23	12.72	1.25	12.65	1.26	12.00	1.21	11.11	1.13	8.07	0.84
43	40	13.43	1.15	13.27	1.17	13.11	1.20	13.04	1.21	12.35	1.15	11.41	1.07	8.22	0.77
47	43	14.23	1.11	14.07	1.14	13.91	1.18	13.78	1.20	13.10	1.14	12.10	1.05	8.70	0.72
53	50	14.03	1.08	13.85	1.11	13.67	1.15	13.71	1.17	12.79	1.09	11.69	0.99	8.02	0.61
59	53	13.86	1.05	13.85	1.10	13.84	1.14	13.71	1.16	12.96	1.09	11.76	0.99	7.91	0.61
64	57	14.11	1.03	13.89	1.04	13.67	1.06	13.58	1.07	12.74	1.01	11.60	0.92	7.83	0.59
70	61	14.16	0.98	13.91	0.97	13.65	0.97	13.54	0.97	12.71	0.91	11.58	0.83	7.87	0.54
75	65	14.36	0.88	14.07	0.91	13.77	0.94	13.52	0.95	12.79	0.89	11.64	0.80	7.80	0.49

DB: Dry Bulb Temperature (°F) WB: Wet Bulb Temperature (°F) TC: Total Capacity (kBtu/h)
 PI: Power Input (kW) (includes compressor, indoor fan motor and outdoor fan motor)
 1. All capacities are net, evaporator fan motor heat is deducted.
 2. Direct interpolation is permissible. Ⓞ Do not extrapolate.

Capacity as rated: 0 ft. above sea level with 24.6 ft. of refrigerant piping, 0 ft. level difference between outdoor and indoor units.
 Heating capacity rating obtained with air entering the indoor unit at 70°F dry bulb (DB) and 60°F wet bulb (WB), and outdoor ambient conditions of 47°F dry bulb (DB) and 43°F wet bulb (WB).

PERFORMANCE DATA

Maximum Heating Capacity LS180HEV2, LS240HEV2

Maximum Heating Capacity Table for LS180HEV2 (LSU180HEV2 + LSN180HEV2)

Table 29: LSN180HEV2 / LSU180HEV2 Heating Capacities.

Outdoor Air Temp.		Indoor Air Temperature (°F DB)													
°F DB	°F WB	60		64		68		70		72		75		86	
		TC	PI	TC	PI	TC	PI	TC	PI	TC	PI	TC	PI	TC	PI
16	14	14.59	2.08	14.38	2.11	14.17	2.14	14.08	2.15	13.66	2.12	13.09	2.08	10.84	1.92
17	15	15.14	2.10	14.93	2.13	14.71	2.16	14.62	2.17	14.19	2.13	13.60	2.06	11.22	1.83
19	17	15.99	2.11	15.77	2.13	15.56	2.15	15.27	2.16	14.96	2.11	14.27	2.05	11.64	1.80
24	23	17.55	2.12	17.32	2.13	17.09	2.13	16.98	2.14	16.31	2.08	15.39	2.00	12.00	1.73
32	30	19.13	2.05	18.89	2.06	18.65	2.06	18.54	2.06	17.65	2.00	16.44	1.90	12.11	1.56
41	38	20.64	1.91	20.39	1.94	20.14	1.98	20.03	2.00	18.99	1.91	17.59	1.78	12.78	1.33
43	40	21.26	1.82	21.01	1.86	20.75	1.90	21.02	1.91	19.55	1.82	18.07	1.69	13.02	1.22
47	43	22.54	1.75	22.28	1.81	22.02	1.87	23.00	1.90	20.74	1.80	19.15	1.66	13.78	1.13
53	50	22.21	1.70	21.93	1.76	21.65	1.82	21.71	1.85	20.24	1.73	18.50	1.56	12.70	0.96
59	53	21.95	1.67	21.93	1.74	21.91	1.81	21.71	1.84	20.51	1.72	18.62	1.56	12.52	0.97
64	57	22.34	1.62	21.99	1.65	21.65	1.68	21.50	1.70	20.17	1.59	18.36	1.45	12.40	0.94
70	61	22.42	1.55	22.02	1.54	21.62	1.54	21.43	1.54	20.12	1.45	18.34	1.32	12.45	0.85
75	65	22.74	1.39	22.27	1.44	21.80	1.48	21.40	1.50	20.26	1.40	18.44	1.27	12.34	0.78

Maximum Heating Capacity Table for LS240HEV2 (LSU240HEV2 + LSN240HEV2)

Table 30: LSN240HEV2 / LSU240HEV2 Heating Capacities.

Outdoor Air Temp.		Indoor Air Temperature (°F DB)													
°F DB	°F WB	60		64		68		70		72		75		86	
		TC	PI	TC	PI	TC	PI	TC	PI	TC	PI	TC	PI	TC	PI
16	14	16.89	2.53	16.65	2.57	16.41	2.61	16.30	2.62	15.82	2.58	15.15	2.53	12.55	2.34
17	15	17.53	2.56	17.28	2.60	17.04	2.63	16.93	2.65	16.43	2.59	15.75	2.51	12.99	2.23
19	17	18.51	2.57	18.26	2.60	18.01	2.62	17.68	2.64	17.32	2.58	16.53	2.49	13.48	2.19
24	23	20.32	2.59	20.05	2.59	19.79	2.60	19.67	2.61	18.88	2.54	17.82	2.44	13.90	2.10
32	30	22.15	2.50	21.87	2.51	21.59	2.51	21.47	2.52	20.44	2.43	19.03	2.32	14.03	1.90
41	38	23.90	2.32	23.61	2.37	23.32	2.42	23.19	2.44	21.99	2.33	20.36	2.18	14.79	1.62
43	40	24.61	2.22	24.32	2.26	24.03	2.31	23.90	2.33	22.64	2.22	20.92	2.06	15.08	1.49
47	43	26.10	2.13	25.80	2.21	25.50	2.29	25.26	2.32	24.01	2.19	22.17	2.02	15.95	1.38
53	50	25.72	2.08	25.39	2.15	25.06	2.22	25.14	2.25	23.44	2.11	21.42	1.91	14.70	1.17
59	53	25.42	2.03	25.39	2.12	25.37	2.21	25.14	2.24	23.75	2.10	21.56	1.90	14.50	1.18
64	57	25.86	1.98	25.47	2.02	25.07	2.05	24.89	2.07	23.36	1.94	21.26	1.77	14.35	1.15
70	61	25.96	1.88	25.50	1.88	25.03	1.88	24.82	1.88	23.30	1.76	21.23	1.61	14.42	1.04
75	65	26.33	1.70	25.79	1.75	25.24	1.81	24.78	1.83	23.45	1.71	21.35	1.55	14.29	0.95

Performance Data

DB: Dry Bulb Temperature (°F) WB: Wet Bulb Temperature (°F) TC: Total Capacity (kBtu/h)
 PI: Power Input (kW) (includes compressor, indoor fan motor and outdoor fan motor)
 1. All capacities are net, evaporator fan motor heat is deducted.
 2. Direct interpolation is permissible. ⚠ Do not extrapolate.

Capacity as rated: 0 ft. above sea level with 24.6 ft. of refrigerant piping. 0 ft. level difference between outdoor and indoor units.

Heating capacity rating obtained with air entering the indoor unit at 70°F dry bulb (DB) and 60°F wet bulb (WB), and outdoor ambient conditions of 47°F dry bulb (DB) and 43°F wet bulb (WB).



PERFORMANCE DATA

Maximum Heating Capacity

LS090HXV2, LS120HXV2

Maximum Heating Capacity Table for LS090HXV2 (LSU090HXV2 + LSN090HXV2)

Table 31: LSN090HXV2 / LSU090HXV2 Heating Capacities.

Outdoor Air Temp.		Indoor Air Temperature (°F DB)													
°F DB	°F WB	60		64		68		70		72		75		86	
		TC	PI	TC	PI	TC	PI	TC	PI	TC	PI	TC	PI	TC	PI
16	14	8.37	1.15	8.25	1.17	8.13	1.18	8.08	1.19	7.84	1.17	7.51	1.15	6.22	1.06
17	15	8.68	1.16	8.56	1.18	8.44	1.19	8.39	1.20	8.14	1.18	7.80	1.14	6.44	1.01
19	17	9.17	1.16	9.05	1.18	8.92	1.19	8.76	1.20	8.58	1.17	8.19	1.13	6.68	0.99
24	23	10.07	1.17	9.93	1.18	9.80	1.18	9.74	1.18	9.36	1.15	8.83	1.11	6.89	0.95
32	30	10.97	1.13	10.84	1.14	10.70	1.14	10.64	1.14	10.13	1.10	9.43	1.05	6.95	0.86
41	38	11.84	1.05	11.70	1.07	11.55	1.10	11.49	1.11	10.90	1.05	10.09	0.99	7.33	0.73
43	40	12.20	1.01	12.05	1.03	11.91	1.05	11.84	1.06	11.22	1.01	10.37	0.93	7.47	0.67
47	43	12.93	0.97	12.78	1.00	12.63	1.04	12.52	1.05	11.90	0.99	10.99	0.91	7.90	0.63
53	50	12.74	0.94	12.58	0.97	12.42	1.01	12.45	1.02	11.61	0.96	10.61	0.86	7.29	0.53
59	53	12.59	0.92	12.58	0.96	12.57	1.00	12.46	1.02	11.77	0.95	10.68	0.86	7.19	0.54
64	57	12.81	0.90	12.62	0.91	12.42	0.93	12.33	0.94	11.57	0.88	10.53	0.80	7.11	0.52
70	61	12.86	0.85	12.63	0.85	12.40	0.85	12.30	0.85	11.55	0.80	10.52	0.73	7.14	0.47
75	65	13.05	0.77	12.78	0.79	12.51	0.82	12.28	0.83	11.62	0.78	10.58	0.70	7.08	0.43

Maximum Heating Capacity Table for LS120HXV2 (LSU120HXV2 + LSN120HXV2)

Table 32: LSN120HXV2 / LSU120HXV2 Heating Capacities.

Outdoor Air Temp.		Indoor Air Temperature (°F DB)													
°F DB	°F WB	60		64		68		70		72		75		86	
		TC	PI	TC	PI	TC	PI	TC	PI	TC	PI	TC	PI	TC	PI
16	14	9.21	1.31	9.08	1.33	8.95	1.35	8.89	1.36	8.63	1.34	8.27	1.31	6.85	1.21
17	15	9.56	1.33	9.43	1.35	9.29	1.36	9.23	1.37	8.96	1.34	8.59	1.30	7.09	1.15
19	17	10.10	1.33	9.96	1.35	9.82	1.36	9.64	1.37	9.45	1.34	9.02	1.29	7.35	1.14
24	23	11.08	1.34	10.94	1.34	10.79	1.35	10.73	1.35	10.30	1.31	9.72	1.27	7.58	1.09
32	30	12.08	1.30	11.93	1.30	11.78	1.30	11.71	1.30	11.15	1.26	10.38	1.20	7.65	0.99
41	38	13.03	1.20	12.88	1.23	12.72	1.25	12.65	1.26	12.00	1.21	11.11	1.13	8.07	0.84
43	40	13.43	1.15	13.27	1.17	13.11	1.20	13.04	1.21	12.35	1.15	11.41	1.07	8.22	0.77
47	43	14.23	1.11	14.07	1.14	13.91	1.18	13.78	1.20	13.10	1.14	12.10	1.05	8.70	0.72
53	50	14.03	1.08	13.85	1.11	13.67	1.15	13.71	1.17	12.79	1.09	11.69	0.99	8.02	0.61
59	53	13.86	1.05	13.85	1.10	13.84	1.14	13.71	1.16	12.96	1.09	11.76	0.99	7.91	0.61
64	57	14.11	1.03	13.89	1.04	13.67	1.06	13.58	1.07	12.74	1.01	11.60	0.92	7.83	0.59
70	61	14.16	0.98	13.91	0.97	13.65	0.97	13.54	0.97	12.71	0.91	11.58	0.83	7.87	0.54
75	65	14.36	0.88	14.07	0.91	13.77	0.94	13.52	0.95	12.79	0.89	11.64	0.80	7.80	0.49

DB: Dry Bulb Temperature (°F) WB: Wet Bulb Temperature (°F) TC: Total Capacity (kBtu/h)

PI: Power Input (kW) (includes compressor, indoor fan motor and outdoor fan motor)

1. All capacities are net, evaporator fan motor heat is deducted.
2. Direct interpolation is permissible. ⚠ Do not extrapolate.

Capacity as rated: 0 ft. above sea level with 24.6 ft. of refrigerant piping. 0 ft. level difference between outdoor and indoor units.

Heating capacity rating obtained with air entering the indoor unit at 70°F dry bulb (DB) and 60°F wet bulb (WB), and outdoor ambient conditions of 47°F dry bulb (DB) and 43°F wet bulb (WB).

EQUIPMENT SELECTION PROCEDURE

Correction Factors

Cooling / Heating Correction Factors

For Single Zone Mega Wall Mounted systems, calculate the equivalent length of the liquid line from the outdoor unit to the indoor unit. Also, determine the elevation difference of the indoor unit above or below the outdoor unit. Find corresponding cooling or heating capacity correction factors as shown below. Multiply the correction factors by the cooling or heating capacity obtained from the capacity tables using design conditions. The resultant is the NET cooling or heating capacity.

Cooling and Heating Capacity Coefficient Factors.

Table 33: Mega Cooling and Heating Capacity Coefficient Factors.

		Operation Mode	Piping Length (ft.)											
			16.4	24.6	32.8	49.2	65.6	82.0	98.4	114.8	131.2	147.6	164.0	
Rate of Capacity Change (%)	LS090HEV2 LS120HEV2	Cooling	100	100	97.7	93.0	-	-	-	-	-	-	-	-
		Heating	100	100	98.3	95.0	-	-	-	-	-	-	-	-
	LS180HEV2 LS240HEV2	Cooling	100	100	99.0	97.0	95.0	-	-	-	-	-	-	-
		Heating	100	100	99.2	97.6	96.0	-	-	-	-	-	-	-

Table 34: Mega 115V Cooling and Heating Capacity Coefficient Factors.

		Operation Mode	Piping Length (ft.)											
			16.4	24.6	32.8	49.2	65.6	82.0	98.4	114.8	131.2	147.6	164.0	
Rate of Capacity Change (%)	LS090HXV2 LS120HXV2	Cooling	100	100	97.7	93.0	-	-	-	-	-	-	-	-
		Heating	100	100	98.3	95.0	-	-	-	-	-	-	-	-

Equivalent Piping Length for Piping Components

Table 35: Equivalent Piping Length for Elbows.

Component	Size (Inches)													
	1/4	3/8	1/2	5/8	3/4	7/8	1	1-1/8	1-1/4	1-3/8	1-1/2	1-5/8	1-3/4	2-1/8
Elbow (ft.)	0.5	0.6	0.7	0.8	1.2	1.3	1.5	1.6	1.8	2.0	2.1	2.3	2.5	2.8

Altitude Correction Factor

The impact of air density must be considered on systems installed at a significant altitude above sea level, therefore, locally accepted altitude correction factors using ASHRAE guidelines must be applied.

EQUIPMENT SELECTION PROCEDURE

Correction Factors

Defrost Correction Factor for Heating Operation

The outdoor unit heating capacity may need to be adjusted for frost accumulation on air-cooled systems. If design day conditions are below the dewpoint of the surrounding air, frost may not be a problem and no correction factor is needed. In certain weather conditions, however, frost may form and accumulate on the air-cooled outdoor unit coil and impact the coils ability to transfer heat. If significant frost accumulates on the outdoor unit coil, a defrost algorithm will start automatically. The timing between defrost periods is determined by the system's ability to achieve a target head pressure value.

Capacity and AHRI ratings tables do not factor in capacity reduction when frost has accumulated on the condenser coil, nor during defrost operation.

Integrated heating capacity values can be obtained using the formula:

$$A = B \times C$$

Where:

A = Integrated Heating Capacity.

B = Value found in the Capacity Table.

C = Correction Factor for Frost Accumulation Factor (from table at right).

Table 36: Outdoor Unit Frost Accumulation Factor (Heating)¹.

Entering DB (°F)	19.4	23.0	26.6	32.0	37.4	41.0	44.6
Derate factor	0.98	0.95	0.93	0.86	0.93	0.96	1.0

¹At 85% outdoor air relative humidity.

The frost accumulation factor does not account for effects of snow accumulation restricting airflow through the outdoor unit coil.

Note:

There will be a temporary reduction in capacity when frost / ice accumulates on the outside surface of the outdoor unit heat exchanger. The level of capacity reduction depends on a number of factors, for example, outdoor temperature (°F DB), relative humidity (RH), and the amount of frost present.

Check the Indoor and Outdoor Unit Selection(s)

Compare the corrected cooling and heating capacities to the load calculations. Is each capacity sufficient for the zone it serves?

For each indoor unit, the corrected capacity must be at least equal to the total of the cooling design load (plus ventilation load, if applicable) for the space served by the indoor unit. For each indoor unit, the corrected capacity also must be at least equal to the total of the heating design load (plus ventilation load, if applicable) for the space(s) and / or thermal zones served by the indoor unit.

The outdoor unit selected must be large enough to offset the total cooling load for all spaces it serves (account for ventilation air cooling load if the ventilation air has not been pretreated to room neutral conditions). The outdoor unit must also be large enough to offset the total heating load for all spaces it serves.

If the corrected heating capacity ratio exceeds 100%, reselect the equipment, or change the system design by moving some of the load to another system.

System Sizing Check Formulas

1. Outdoor Unit Rated Capacity.

$Q_{odu(rated)}$ (From capacity tables).

2. Outdoor Unit Capacity at T_i , T_o Temperature.

$Q_{odu(T_i, T_o)}$ (From capacity tables).

3. Outdoor Unit Capacity Coefficient Factor.

$$F_{(T_i, T_o)} = Q_{odu(T_i, T_o)} / Q_{odu(rated)}$$

4. Piping Correction Factor (From Capacity Coefficient Factor Tables).

$F_{(length)}$ for each piping length

5. Individual Indoor Unit Combination Capacity.

$$Q_{idu(combi)} = Q_{odu(rated)} \times Q_{idu(rated)} / Q_{idu(rated-total)}$$

6. Individual Indoor Unit Actual Capacity.

$$Q_{idu(actual)} = Q_{odu(combi)} \times F_{(T_i, T_o)} \times F_{(length, altitude)}$$

Conclusions and Recommendations

- Understand the design safety factors.
- Reference load calculations for actual cooling and heating capacities (applies in 99% of applications – consider total load when latent load is greater than 30%).
- Verify that the sensible load of the zone is satisfied.
- Use caution when sizing to meet listed capacity specifications for the scheduled manufacturer's equipment.

If further system design assistance is needed, or you have a unique application you would like to discuss, contact your LG sales rep.

APPLICATION GUIDELINES

Placement Considerations on page 62

Installing Outdoor Units Indoors on page 67

Refrigerant Piping Design on page 70

PLACEMENT CONSIDERATIONS

Indoor Unit

Selecting the Best Location for the Indoor Unit

Note:

Follow recommended best practices when choosing an indoor location for the single zone indoor unit.

Dos

- Follow the table at right for minimum clearance of indoor unit from the top of the unit to the ceiling.
- Clearance gap between any wall or enclosure and the left or right side of the unit must be greater than 4 inches. Ensure there is sufficient maintenance space.
- Unit must be at least 6-1/2 feet from the floor for adequate clearance.
- Place the unit where drainage can be obtained easily. Condensation drain must be conveniently routed away from the unit.
- Locate the indoor unit in a location where it can be easily connected to the outdoor unit within allowable limits.
- Use a metal detector to locate studs in the walls. Anchor unit following stud location to prevent damage to the wall.

⊘ Dont's

- Do not install the unit near a heat or steam source, or where considerable amounts of oil, iron powder, or flour are used. (These materials will generate condensate, cause a reduction in heat exchanger efficiency, or the drain to malfunction. If this is a potential problem, install a ventilation fan large enough to vent out these materials.)
- Ensure there are no obstacles to air circulation around the unit; keep proper distances from ceilings, doorways, floor, walls, etc.
- Do not install in an area where operation sound will disturb occupants--place the unit where noise prevention is taken into consideration
- Do not install near doorway.
- Avoid installing the unit near high-frequency generators.

⚠ WARNING

The unit must not be installed where sulfuric acid and flammable or corrosive gases are generated, vented into, or stored. There is risk of fire, explosion, and physical injury or death.

The unit will be damaged, will malfunction, and / or will not operate as designed if installed in any of the conditions listed.

Note:

- Indoor units (IDUs) must not be placed in an environment where the IDUs will be exposed to harmful volatile organic compounds (VOCs) or in environments where there is improper air make up or supply or inadequate ventilation. If there are concerns about VOCs in the environment where the IDUs are installed, proper air make up or supply and/ or adequate ventilation must be provided. Additionally, in buildings where IDUs will be exposed to VOCs consider a factory-applied epoxy coating to the fan coils for each IDU.
- If the unit is installed near a body of water, the installation parts are at risk of corroding. Appropriate anti-corrosion methods must be taken for the unit and all installation parts.

Installing in an Area Exposed to Unconditioned Air

In some installation applications, areas (floors, walls) in some rooms will be exposed to unconditioned air (room will be above or next to an unheated garage or storeroom). To countermeasure:

- Verify that carpet is or will be installed (carpet will increase the temperature by three [3] degrees).
- Add insulation between the floor joists.
- Install radiant heat or another type of heating system to the floor.

Figure 30: Mega Indoor Unit Clearance Requirements.
Unit: Inch (mm)

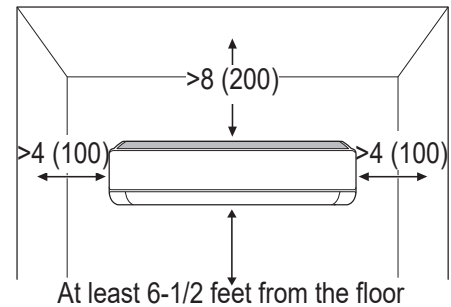
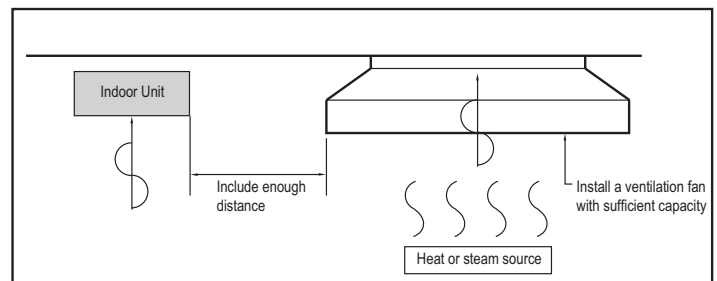

Table 37: Mega Indoor Unit Ceiling Clearance.

Ceiling Clearance (inches)	Indoor Unit Model(s)
8	LSN090HEV2, LSN120HEV2, LSN180HEV2, LSN240HEV2, LSN090HXV2, LSN120HXV2

Figure 31: Installing Near a Heat or Steam Source.





PLACEMENT CONSIDERATIONS

Outdoor Unit

Selecting the Best Location for the Outdoor Unit

⚠ DANGER

-  Do not install the unit in an area where combustible gas will generate, flow, stagnate, or leak. These conditions can cause a fire, resulting in bodily injury or death.
-  Do not install the unit in a location where acidic solution and spray (sulfur) are often used as it can cause bodily injury or death.
-  Do not use the unit in environments where oil, steam, or sulfuric gas are present as it can cause bodily injury or death.

⚠ CAUTION

When deciding on a location to place the outdoor unit, be sure to choose an area where run-off from defrost will not accumulate and freeze on sidewalks or driveways, which will create unsafe conditions. Properly install and insulate any drain hoses to prevent the hose from freezing, cracking, leaking, and causing unsafe conditions from frozen condensate.

⚠ WARNING

Install a fence to prevent vermin from crawling into the unit or unauthorized individuals from accessing it. Vermin and unauthorized individuals will cause a fire, electric shock, physical injury or death. Follow the placement guidelines set forth in "Clearance Requirements".

Note:

Install a fence to prevent vermin from crawling into the unit or unauthorized individuals from accessing it. Vermin and unauthorized individuals will damage the unit. Follow the placement guidelines set forth in "Clearance Requirements".

Select a location for installing the outdoor unit that will meet the following conditions:

- Where there is enough strength to bear the weight of the unit.
- A location that allows for optimum air flow and is easily accessible for inspection, maintenance, and service.
- Where piping between the outdoor unit and indoor unit is within allowable limits.
- Include space for drainage to ensure condensate flows properly out of the unit when it is in heating mode.  Avoid placing the outdoor unit in a low-lying area where water could accumulate.
- If the outdoor unit is installed in a highly humid environment (near an ocean, lake, etc.), ensure that the site is well-ventilated and has a lot of natural light (Example: Install on a rooftop).

Dont's

- Where it will be subjected to direct thermal radiation from other heat sources, or an area that would expose the outdoor unit to heat or steam like discharge from boiler stacks, chimneys, steam relief ports, other air conditioning units, kitchen vents, plumbing vents, and other sources of extreme temperatures.
- Where high-frequency electrical noise / electromagnetic waves will affect operation.
- Where operating sound from the unit will disturb inhabitants of surrounding buildings.
- Where the unit will be exposed to direct, strong winds.
- Where the discharge of one outdoor unit will blow into the inlet side of an adjacent unit (when installing multiple outdoor units).

Outdoor Unit Condensate Drain Piping

Outdoor unit requires condensate drain piping. Condensate drain pipe is constructed with materials approved by local code. See page 66 for information in reference to outdoor unit placement.

Planning for Snow and Ice

To ensure the outdoor unit operates properly, certain measures are required in locations where there is a possibility of heavy snowfall or severe windchill or cold:

1. Prepare for severe winter wind chills and heavy snowfall, even in areas of the country where these are unusual phenomena.
2. Position the outdoor unit so that its airflow fans are not buried by direct, heavy snowfall. If snow piles up and blocks the airflow, the system will malfunction.
3. Remove any snow that has accumulated four (4) inches or more on the top of the outdoor unit.
4. In climates that will experience significant snow buildup, mount the outdoor unit on a raised, field-provided platform or stand. The raised support platform must be high enough to allow the unit to remain above possible snow drifts, and must be higher than the maximum anticipated snowfall for the location.
5. Design the mounting base to prevent snow accumulation on the platform in front or back of the unit frame.
6. Provide a field fabricated snow protection hood to keep snow and ice and/or drifting snow from accumulating on the coil surfaces.
7. To prevent snow and heavy rain from entering the outdoor unit, install the condenser air inlets and outlets facing away from direct winds.
8. Consider tie-down requirements in case of high winds or where required by local codes.



PLACEMENT CONSIDERATIONS

Outdoor Unit

Planning for Snow and Ice, continued.

⚠ CAUTION

When deciding on a location to place the outdoor unit, be sure to choose an area where run-off from defrost will not accumulate and freeze on sidewalks or driveways, which will create unsafe conditions. Properly install and insulate any drain hoses to prevent the hose from freezing, cracking, leaking, and causing unsafe conditions from frozen condensate.

Underground Refrigerant Piping

Refrigerant pipe installed underground must be routed inside a vapor tight protective sleeve to prevent insulation deterioration and water infiltration. Refrigerant pipe installed inside underground casing must be continuous without any joints. Underground refrigerant pipe must be located at a level **below the frost line**.

Table 38: Utility Conduit Sizes (Inches).

Liquid Pipe ¹	Vapor Pipe ¹			
	3/8 (2.0 ^{2,5})	1/2 (2.0 ^{2,5})	5/8 (2-1/8 ^{2,5})	3/4 (2-1/4 ^{2,5})
1/4 (1.0) ³	4	4	4	4
3/8 (1-1/8) ³	4	4	4	5
1/2 (1-1/2) ⁴	5	5	5	5
5/8 (1-5/8) ⁴	5	5	5	5
3/4 (1-3/4) ⁴	5	5	5	5

¹OD pipe diameter in inches; Values in parenthesis () indicate OD of pipe with insulation jacket.
²Diameter of pipe with insulation. Thickness of pipe insulation is typical. Actual required thickness will vary based on surrounding ambient conditions and must be calculated and specified by the design engineer.
³Insulation thickness (value in parenthesis) = 3/8 inch.
⁴Insulation thickness (value in parenthesis) = 1 inch.
⁵Insulation thickness (value in parenthesis) = 3/4 inch.

Tie-Downs and Lightning Protection

Tie-Downs

- The strength of the roof must be checked before installing the outdoor units.
- If the installation site is prone to high winds or earthquakes, when installing on the wall or roof, securely anchor the mounting base using a field-provided tie-down configuration approved by a local professional engineer.
- The overall tie-down configuration must be approved by a local professional engineer.

Note:

Always refer to local code when using a wind restraint system.

Lightning Protection

- To protect the outdoor unit from lightning, it must be placed within the specified lightning safety zone.

Table 40: Safety Zone Specifications.

Building Height (feet)	66	98	148	197
Protection Angle (°)	55	45	35	25

- Power cable and communication cable must be installed five (5) feet away from lightning rod.
- A high-resistance ground system must be included to protect against induced lightning or indirect strike.

Note:

If the building does not include lightning protection, the outdoor unit will be damaged from a lightning strike. Inform the customer of this possibility in advance.

Figure 32: Typical Arrangement of Single Zone Refrigerant Pipe and Cable(s) in a Utility Conduit.

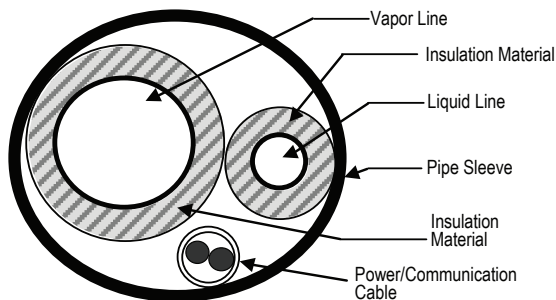
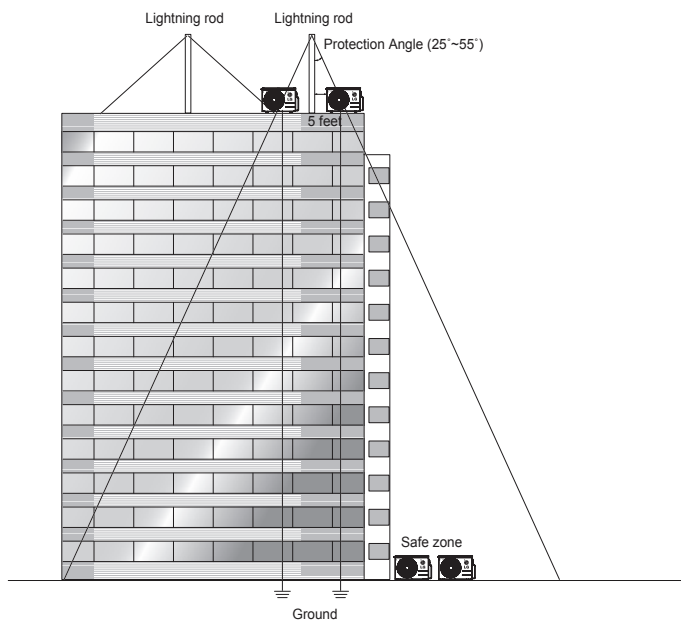

Table 39: Outdoor Unit Refrigerant Pipe Connections.

Model	Liquid Conn. (inches)	Vapor Conn. (inches)
LS090HEV2, LS120HEV2, LS090HXV2, LS120HXV2	1/4	3/8
LS180HEV2, LS240HEV2	1/4	1/2

Figure 33: Lightning Protection Diagram.



PLACEMENT CONSIDERATIONS

Outdoor Unit

Oceanside Applications

Use of a Windbreak to Shield from Sea Wind

Note:

Ocean winds will cause corrosion, particularly on the condenser and evaporator fins, which, in turn could cause product malfunction or inefficient performance.

- Avoid installing the outdoor unit where it would be directly exposed to ocean winds.
- Install the outdoor unit on the side of the building opposite from direct ocean winds.
- Select a location with good drainage.
- Periodically clean dust or salt particles off of the heat exchanger with water.
- If the outdoor unit must be placed in a location where it would be subjected to direct ocean winds, install a concrete windbreak strong enough to block any winds.
- Windbreak must be more than 150% of the outdoor unit's height. There must be 2 to 3-1/2 inches of clearance between the outdoor unit and the windbreaker for purposes of air flow.

Use of a Building to Shield from Sea Wind

If a windbreak is not possible, a building or larger structure must be used to shield the outdoor unit from direct exposure to the sea wind. The unit must be placed on the side of the building directly opposite to the direction of the wind as shown in the figure at right.

Figure 34: Oceanside Placement Using Windbreak.

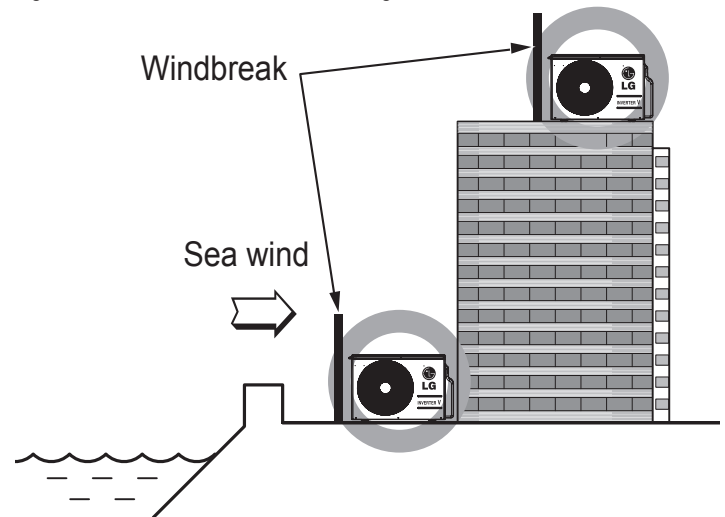

Note:

Additional anti-corrosion treatment will need to be applied to the outdoor unit at oceanside locations.

Figure 35: Placement Using Building as Shield.

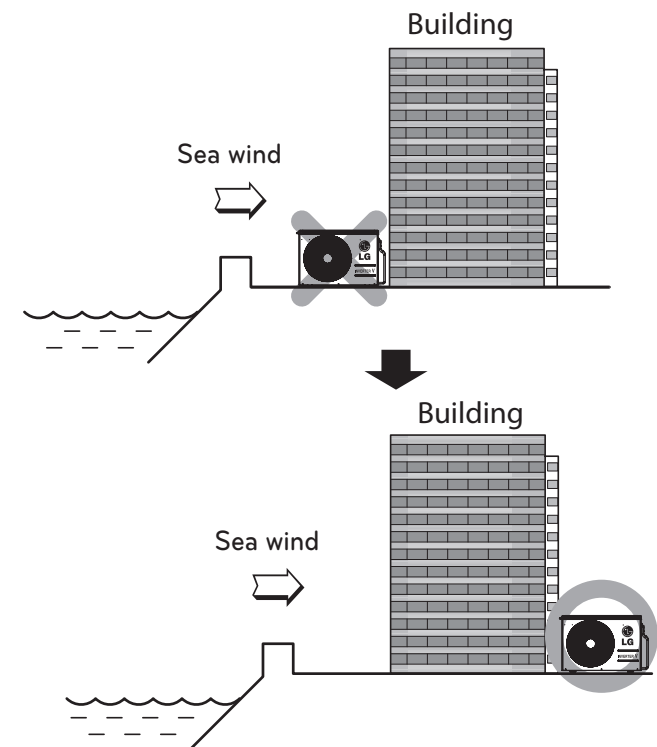

PLACEMENT CONSIDERATIONS

Outdoor Unit

Minimum Allowable Clearance and Service Access Requirements

Proper clearance for the outdoor unit coil is critical for proper operation. When installing the outdoor unit, consider service, inlet and outlet, and minimum allowable space requirements as illustrated in the diagrams below.

- Include enough space for airflow and for service access. If installing multiple outdoor units, ⓧ avoid placing the units where the discharge of one unit will blow into the inlet side of an adjacent unit.
- If an awning is built over the unit to prevent direct sunlight or rain exposure, make sure that the discharge air of the outdoor unit isn't restricted.
- ⓧ No obstacles to air circulation around the unit; keep proper distances from ceilings, fences, floor, walls, etc. (Install a fence to prevent pests from damaging the unit or unauthorized individuals from accessing it.)

Mega and Mega 115V Outdoor Unit Service Access and Allowable Clearances

Specific clearance requirements in the diagram below are for all Mega outdoor units. The figure below shows the overall minimum clearances that must be observed for safe operation and adequate airflow around the outdoor unit.

When placing the outdoor unit under an overhang, awning, sunroof or other "roof-like structure", observe the clearance requirements (as shown in Cases 1 and 2) for height in relation to the unit. To have successful service access to the outdoor unit, see figure below for minimum spacing. When installing multiple outdoor units, see Cases 4 and 5 for correct spacing requirements.

Note:

If the outdoor unit is installed between standard and minimum clearances, capacity decreases approximately 10%.

Figure 36: Single Zone Mega and Mega 115V Outdoor Unit Service Access and Allowable Clearances Diagram.

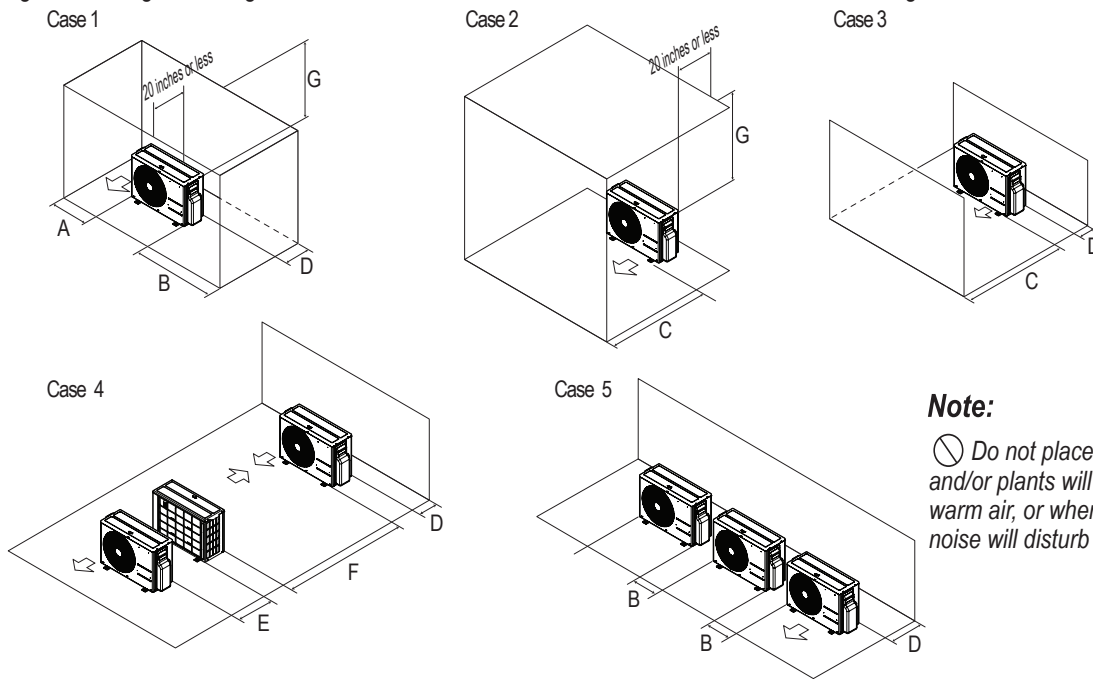

Note:

ⓧ Do not place the unit where animals and/or plants will be in the path of the warm air, or where the warm air and/or noise will disturb neighbors.

Table 41: Single Zone Mega and Mega 115V Outdoor Unit Service Access and Allowable Clearances Diagram Legend.

Unit: Inch		A	B	C	D	E	F	G
Case 1	Standard	12	24	-	12	-	-	-
	Minimum	4	10	-	4	-	-	40
Case 2	Standard	-	-	20	-	-	-	-
	Minimum	-	-	14	-	-	-	40
Case 3	Standard	-	-	20	12	-	-	-
	Minimum	-	-	14	4	-	-	-
Case 4	Standard	-	-	-	12	24	-	-
	Minimum	-	-	-	4	8	79	-
Case 5	Standard	-	24	-	12	-	-	-
	Minimum	-	10	-	4	-	-	-

PLACEMENT CONSIDERATIONS

Installing Outdoor Units Indoors

Installing Outdoor Units Indoors

Single Zone Mega and Mega 115V Wall Mount outdoor units are engineered to be mounted outdoors and include technology designed to minimize the negative effects of winter weather's freezing rain, sleet, and snow. Some building projects, however, necessitate placing the HVAC outdoor units indoors:

- Lack of ground space.
- Lack of an appropriate outdoor location that meets system design requirements.
- When mounting on the roof is not an option due to a lack of roof space.
- Roof warranty will be voided if mechanical equipment is placed on the membrane.
- On retrofit projects, a former chiller / boiler / air handler equipment room, mechanical area, or penthouse already exists.
- To curtail the potential need for redundant zone heating devices such as wall-fin radiators or duct heaters.
- In extremely cold environments where there is a significant amount of run-time at temperatures well below freezing outside the outdoor unit ambient air temperature range published in this engineering manual.

Benefits of Installing Outdoor Units Indoors

- Shelters the outdoor unit from direct exposure to prevailing winds that decrease the heating capability of the outdoor unit.
- Protects equipment from freezing precipitation and / or potential ice build-up that could hinder unit operation.
- Maintains coil heat transfer efficiency by reducing the number of and shortening the cycle time for defrost operation.
- Easier maintenance and servicing during inclement weather.
- When mounted in a fully enclosed space, limiting the ambient air temperature will allow the Single Zone Mega and Mega 115V Wall Mount system designer to eliminate oversizing.
- The outdoor unit to compensate for loss of capacity at low ambient temperatures.
- Will also curtail the need to provide inefficient redundant zone heating devices such as wall-fin radiators and second-stage ancillary heating devices.

Design Considerations Include:

- Enclosure types and elements such as louvers (see next page), rain hoods, dampers and controls, heating methods and sizing of heating devices.
- Heating strategies.
- Duct design.
- Condensate handling.

General Guidelines

- Follow ASHRAE 62.1 design guidelines.
- Depending on the project / application, a roof over the outdoor units in combination with a wind break will be all that is necessary.
- Consider the potential for snow accumulation near louvers / roof openings. Outside air intakes and discharge ducts/louvers must be engineered to clear anticipated snow accumulation levels by at least one (1) foot.
- In situations where operation is anticipated at temperatures lower than the product's minimum operating temperature, ancillary heat must be provided to heat the outdoor unit coils to ensure continuous compressor operation and heating.

It will be necessary to use a field-fabricated air guide to prevent discharge air from short-cycling back to the coil inlet.

- Consider the direction of prevailing winds and opening placement. If possible, locate inlet openings upwind of discharge openings and other exhaust outlets.
- When inlet and outlet openings are placed on the same wall, minimum distance between the two openings must be approximately three (3) feet (minimum distance varies significantly with variations in outlet opening face velocity).
- If roof-mounted ventilation openings are used, strategically locate the inlet ventilation opening(s) upwind of the outlet opening(s).
- Discharge and supply ductwork must be designed to avoid weather related long periods of water entrainment and the potential for microbial growth.

PLACEMENT CONSIDERATIONS

Installing Outdoor Units Indoors

Provide a means to drain the condensate generated during heating mode and defrost cycle in addition to rainwater that infiltrates the inlet louver enclosed area.

- Install a field-provided drain pan under the outdoor units and provide a path to a nearby floor drain.
- If the ambient air temperature is expected to drop below 32°F in the enclosure, heat the bottom surface of the pan, drain line, and floor drain so that the condensate does not freeze before reaching the drain.

⚠ CAUTION

When deciding on a location to place the outdoor unit, be sure to choose an area where run-off from defrost will not accumulate and freeze on sidewalks or driveways which will create unsafe conditions.

Allow for ventilation intake and exhaust air based on maximum outdoor unit fan capacity.

- Select the size, type and orientation of architectural louvers with adequate “net free area” face velocity to ensure the total external static pressure from the outdoor unit fan does not exceed design limitations (see specification data tables).
- No obstructions must be placed in front of the louver that could hamper the free flow (throw) of air.
- Roof top openings and / or discharge and supply louvers must be equipped with screens to prevent bird and insect infiltration.

Note:

For louver recommendations, see below and on the next page.

As always, the best solution for each project balances acceptable heating performance (considering local weather conditions), capital costs, life cycle energy consumption, and limitations set forth by local building codes.

Louver Recommendations for Outdoor Unit Enclosure

1. Outdoor Unit Enclosure: Manual Door Open Type.
2. Louver Angle: No More Than 15° Horizontally.
3. Space Between Louvers: More than 4 inches (Recommend).
4. Louver Shape: Wing or Plane Type.

Note:

- Open Rate and Inlet must be taken into consideration when designing the louvered outdoor unit enclosure.
- Do not use “S” type louvers.

Note:

If the Louver Open Rate is Too Small

1. Noise can occur because of the increased air velocity passing through the louver blade.
2. Noise can occur from louver blade vibrations.
3. A drop in outdoor unit fan performance (excess static pressure can cause a drop in outdoor unit performance and heat exchanger efficiency).
4. If the louver open rate is too small or there is insufficient air flow exchange, the air conditioner might stop operating.

Figure 37: Louver Recommendations.

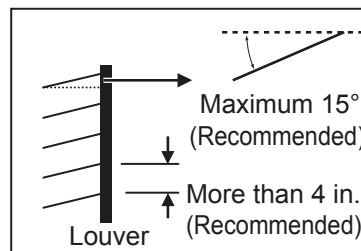
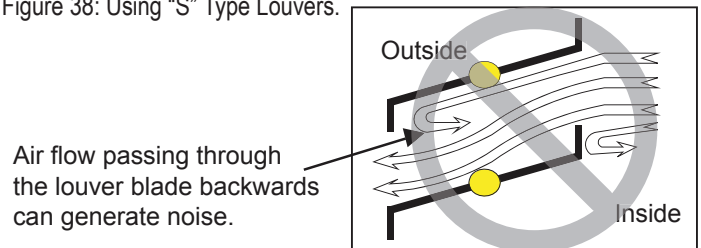

Figure 38: Using “S” Type Louvers.



PLACEMENT CONSIDERATIONS

Installing Outdoor Units Indoors

Open Rate by Louver Radian

Figure 39: Open Rate by Louver Radian Formula.

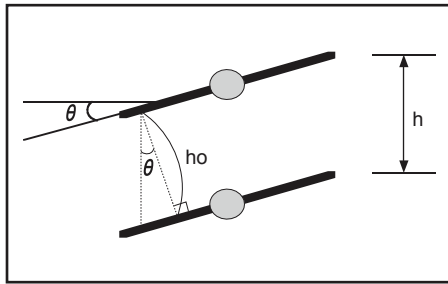

$$\theta \leq 15$$

$$h_o = h * \text{COS } \theta$$

$$\text{Total Area (A)} = H * W$$

$$\text{Number of Open Spaces (N)} = (\text{Number of Louvers} - 1)$$

$$\text{Effective Area (Af)} = h_o * W * N$$

$$\text{Louver Open Rate (n)} = \text{Af} / \text{A}$$

$$\therefore \text{Af} = \text{A} * n$$

Effective Cross Section Area

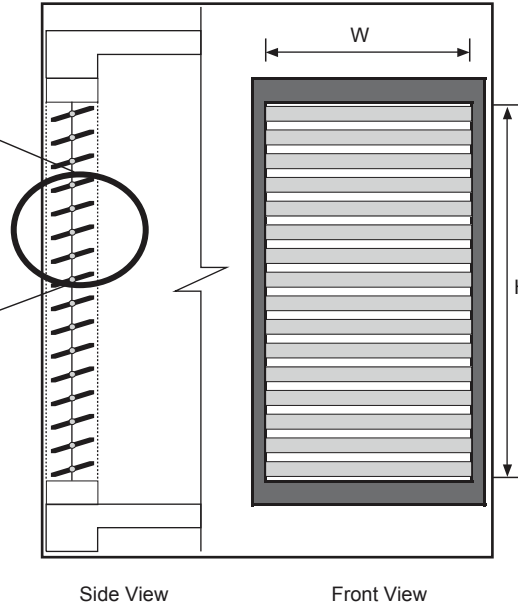

Confirming Air Flow Rate / Total Opening Rate

- Example: LSU180HSV5.

- Discharge Airflow Rate: 2,119 ft.³/min.

- Velocity of Outlet Air: 16.4 ft./s

- Velocity of Inlet Air: 8.2 ft./s

- Open Rate = 80% or More

$$\text{Open Rate} = \frac{\text{Effective Face Area (Af)}}{\text{Total Face Area (A)}}$$

- Inlet airflow must match or exceed discharge airflow.
- Separate inlet airflow from discharge airflow to prevent recirculation.

Figure 40: Example of Installing Outdoor Unit Indoors.

Louver Dimensions

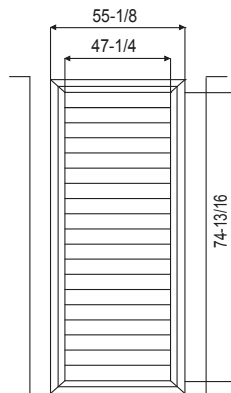

Unit: Inch

Air Guide Duct on Outdoor Unit

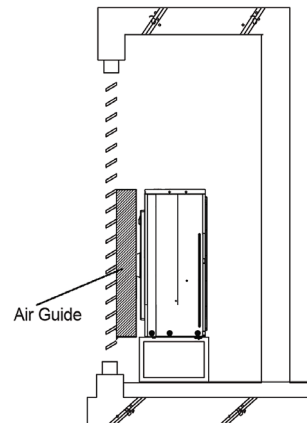

Outdoor Unit Dimensions

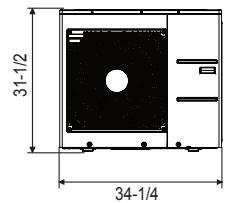

Formula

- Total Louver Dimension (Excluding Frame) (A) = 3.9 feet x 6.2 feet = 24.2 ft.²
- Area Blocked by Outdoor Unit (Discharge) (B) = 2.6 feet x 2.8 feet = 7.41 ft.²
- Inlet Louver Dimension (A - B) = 16.8 ft.²
- Equivalent Inlet Dimension (Open Rate 80%) = 16.8 ft.² x 0.8 = 13.44 ft.²
- Equivalent Inlet Airflow = 13.44 ft.² x 8.2 ft./s x 60 sec./min. = 6,612 ft.³/min.
- Equivalent Inlet Airflow / Discharge Airflow = 6,612 ft.³/min. / 2,119 ft.³/min. = 312% (Within Allowable Limits)

REFRIGERANT PIPING DESIGN

Design Guideline Summary

Device Connection Limitations

Single-zone systems consist of one outdoor unit and one indoor unit. One of the most critical elements of a single zone system is the refrigerant piping. The table below lists pipe length limits that must be followed in the design of a Single Zone Mega or Mega 115V refrigerant pipe system. Refer to the figure at right for maximum length and elevation of piping.

Figure 41: Mega and Mega 115V System Layout.

Max Length = A
Max Elevation = B
Unit = Feet

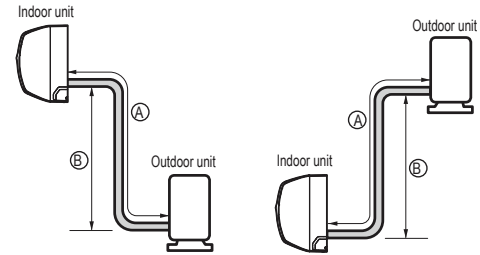

Table 42: Single Zone Mega and Mega 115V Wall Mount Refrigerant Piping System Limitations.

Model Numbers		LS090HEV2, LS120HEV2	LS180HEV2, LS240HEV2	LS090HXV2, LS120HXV2
Pipe Sizes	Vapor	3/8 inches	1/2 inches	3/8 inches
	Liquid	1/4 inches	1/4 inches	1/4 inches
Pipe Length (ELF = Equivalent Length of pipe in Feet)	Standard Piping Length	24.6	24.6	24.6
	Piping Length with No Additional Refrigerant	24.6	24.6	24.6
	Longest total equivalent piping length	49.2	65.6	49.2
	Shortest total equivalent piping length	9.8	9.8	9.8
	Distance between fittings and indoor units or outdoor units	≥20 inches	≥20 inches	≥20 inches
Elevation (All Elevation Limitations are Measured in Actual Feet)	If outdoor unit is above indoor unit	23 feet	32.8 feet	23 feet
	If outdoor unit is below indoor unit	23 feet	32.8 feet	23 feet
Additional Refrigerant Needed (oz/ft)		0.22	0.26	0.22

Table 43: Single Zone Mega and Mega 115V Piping System Additional Refrigerant Charge.

Model Numbers		Refrigerant Piping Length (ft.)											
		16.4	24.6	32.8	41.0	49.2	65.6	82.0	98.4	114.8	131.2	147.6	164.0
Mega													
LS090HEV2 (LSN090HEV2 / LSU090HEV2)	Additional Refrigerant Charge (oz.)	0	0	1.8	3.6	5.4	-	-	-	-	-	-	-
LS120HEV2 (LSN120HEV2 / LSU120HEV2)		0	0	1.8	3.6	5.4	-	-	-	-	-	-	-
LS180HEV2 (LSN180HEV2 / LSU180HEV2)		0	0	2.1	4.3	6.4	10.7	-	-	-	-	-	-
LS240HEV2 (LSN240HEV2 / LSU240HEV2)		0	0	2.1	4.3	6.4	10.7	-	-	-	-	-	-
Mega 115V													
LS090HXV2 (LSN090HXV2 / LSU090HXV2)	Additional Refrigerant Charge (oz.)	0	0	1.8	3.6	5.4	-	-	-	-	-	-	-
LS120HXV2 (LSN120HXV2 / LSU120HXV2)		0	0	1.8	3.6	5.4	-	-	-	-	-	-	-

Note:

- Capacity is based on standard length.
- Equivalent Pipe Length = Actual Pipe Length + Number of Bends x 0.3.
- Additional Refrigerant Charge Calculation : $X (g) = [(Refrigerant\ Pipe\ Length) - (No\ Charge\ Pipe\ Length)] \times (Additional\ Refrigerant)$.
- There is no need to add refrigerant if equivalent pipe is less than the "piping length with no additional refrigerant" in the table above.

Inverter



LG Electronics, U.S.A., Inc.
Air Conditioning Technologies
4300 North Point Parkway
Alpharetta, Georgia 30022
www.lghvac.com

EM_SZ_Mega_HEV2_Mega115V_HXV2_04_20
Supersedes: EM_SZ_Mega_HEV2_Mega115V_HXV2_08_19
EM_SZ_Mega_HEV2_Mega115V_HXV2_07_19
EM-SZ_Mega_Mega115V_05_19
EM-SZ_Mega_Mega115V-3-16
EM-SZ_Mega_Mega115V-4-15
EM-SZ_Mega_Mega115V-10-14