



R32 SINGLE-ZONE FOUR-WAY CASSETTE ENGINEERING MANUAL



KSUDB091A (9,000 Btu/h)
KSUDB121A (12,000 Btu/h)



KSUDB181A (18,000 Btu/h)



KSSCB361A (36,000 Btu/h)
KSSCB421A (42,000 Btu/h)
KSSCB481A (48,000 Btu/h)



KSSCB241A (24,000 Btu/h)



KSSCB301A (30,000 Btu/h)

PROPRIETARY DATA NOTICE

**This document, as well as all reports, illustrations, data, information, and other materials are the property of LG Electronics U.S.A., Inc., and are disclosed by LG Electronics U.S.A., Inc. only in confidence.
This document is for design purposes only.**

A summary list of safety precautions is on page 6.

For more technical materials such as submittals, catalogs, installation, owner's, and service manuals, visit www.lghvac.com.

Proper sizing and installation of equipment is critical to achieve optimal performance. Split system air conditioners and heat pumps (excluding ductless systems) must be matched with appropriate coil components to meet ENERGY STAR® criteria. Ask your contractor for details or visit www.energystar.gov.

(ENERGY STAR and the ENERGY STAR mark are registered trademarks owned by the U.S. Environmental Protection Agency.)

For continual product development, LG Electronics U.S.A., Inc., reserves the right to change specifications without notice.

© LG Electronics U.S.A., Inc.

This document, as well as all reports, illustrations, data, information, and other materials are the property of LG Electronics U.S.A., Inc.

LG AIR CONDITIONER TECHNICAL SOLUTION (LATS)

LG Air Conditioner Technical Solution (LATS) Software

A properly designed and installed refrigerant piping system is critical to the optimal performance of LG air-conditioning systems. To assist engineers, LG offers, free of charge, LG Air Conditioner Technical Solution (LATS) software—a total design solution for LG air conditioning systems. Contact your LG Rep for the best software program for your application.

NOTICE

To reduce the risk of designing an improper applied system or one that will not operate correctly, LG requires that LATS software be used on all projects.

Formats

LATS is available to LG customers in two user interfaces: LATS HVAC and LATS Revit. Both LATS formats are available through www.myLGHVAC.com, or contact an LG Sales Representative.

LATS HVAC is a Windows®-based application that aids engineers in designing LG Variable Refrigerant Flow (VRF), Multi F / Multi F MAX, Single-Zone, DOAS, and Energy Recovery Ventilator (ERV) systems.

*Windows® is a registered mark of Microsoft® Corporation.

LATS Revit integrates the LG LATS program with Revit® software**. It permits engineers to layout and validate LG VRF, Multi F / Multi F MAX, Single-Zone, and DOAS directly into Revit drawings.

**Revit® is a registered mark of Autodesk, Inc.

Features

All LG product design criteria have been loaded into the program, making LATS simple to use: double click or drag and drop the component choices. Build systems in Tree Mode where the refrigerant system can be viewed. Switch to a Schematic diagram to see the electrical and communications wiring.

LATS software permits the user to input region data, indoor and outdoor design temperatures, modify humidity default values, zoning, specify type and size of outdoor units and indoor units, and input air flow and external static pressure (ESP) for ducted indoor units.

The program can also:

- Import building loads from a separate Excel file.
- Present options for outdoor unit auto selection.
- Automatically calculate component capacity based on design conditions for the chosen region.
- Verify if the height differences between the various system components are within system limits.
- Provide the correct size of each refrigerant piping segment and LG Y-Branches and Headers.
- Adjust overall piping system length when elbows are added.
- Check for component piping limitations and flag if any parameters are broken.
- Factor operation and capacity for defrost operation.
- Calculate refrigerant charge, noting any additional trim charge.
- Suggest accessories for indoor units and outdoor units.
- Run system simulation.

NOTICE

Features depend on which LATS program is being used, and the type of system being designed. Contact your LG representative for the best software program for your application.

NOTICE

Any field changes, such as re-routing, shortening or lengthening a pipe segment, adding or eliminating elbows and/or fittings, re-sizing, adding, or eliminating indoor units, changing the mounting height, or moving the location of a device or fitting during installation must be done with caution and ALWAYS VERIFIED in LATS SOFTWARE BEFORE supplies are purchased or installed. Doing so will lead to a more profitable installation, reduce the potential for rework, and will reduce the potential for multiple visits to the job site to complete the system set up.

Figure 1: LATS Example (Tree Diagram; Illustrative Purposes Only. System will Vary Depending On Model).



LG AIR CONDITIONER TECHNICAL SOLUTION (LATS)

LATS Generates a Complete Project Report

LATS software also generates a report containing project design parameters, cooling and heating design data, system component performance, and capacity data. The report includes system combination ratio and refrigerant charge calculations; and provides detailed bill of material, including outdoor units, indoor units, control devices, accessories, refrigerant pipe sizes segregated by building, by system, by pipe size, and by pipe segments. LATS can generate an Excel GERP report that can be imported into the LG SOPS pricing and ordering system.

Proper Design to Install Procedure

LG encourages a two report design-to-install-procedure. After the design engineer determines building / zone loads and other details, the engineer opens the LATS program and inputs the project's information. When the design is complete, the "Auto Piping" and "System Check" functions must be used to verify piping sizes, limitations, and if any design errors are present. If errors are found, engineers must adjust the design, and run Auto Piping and System Check again. When the design passes the checks, then the engineer prints out a project "Shop Drawing" (LATS Tree Diagram) and provides it to the installing contractor. The contractor must follow the LATS Tree Diagram when building the piping system, but oftentimes the design changes on the building site:

- Architect has changed location and/or purpose of room(s).
- Outdoor unit cannot be placed where originally intended.
- Structural elements prevent routing the piping as planned.
- Air conditioning system conflicts with other building systems (plumbing, gas lines, etc.).

The contractor must mark any deviation from the design on the Shop Drawing, including as-built straight lines and elbows. This "Mark Up" drawing must be returned to the design engineer or Rep, who must input contractor changes into the LATS file. (Copy the original LATS software file, save and rename as a separate file, and modify all piping lengths by double-clicking on each length and editing information.) Like the shop drawing, the Auto Piping and System Check must also be run on this new "As Built" drawing. The design engineer or Rep must then provide the final As Built file to the contractor. The Mark Up version must be compared to the As Built version for:

- Differences in pipe diameter(s). If incorrect diameters have been installed, the piping must be changed out. If pipe diameters have changed, check if Y-Branched will also need to be changed.
- Changes to outdoor unit and indoor unit capacities. Capacities changes will impact line length changes.
- Additional refrigerant charge quantity ("Trim Charge"). Trim charge will change if piping lengths and diameters change. The As Built version must reflect installed piping lengths to ensure correct trim charge.

All documents submitted by the contractor, as well as the Shop Drawing and the As Built Drawing files must be provided for commissioning purposes. Model and serial numbers for all system components must also be submitted. If the steps previously detailed are not followed, and all documents are not provided to the commissioning agent, the project runs the risk of not being commissioned and voiding any limited warranty LG offers on the equipment.



NOTICE

Any field changes, such as re-routing, shortening or lengthening a pipe segment, adding or eliminating elbows and/or fittings, re-sizing, adding, or eliminating indoor units, changing the mounting height, or moving the location of a device or fitting during installation must be done with caution and ALWAYS VERIFIED in LATS SOFTWARE BEFORE supplies are purchased or installed. Doing so will lead to a more profitable installation, reduce the potential for rework, and will reduce the potential for multiple visits to the job site to complete the system commissioning.

TABLE OF CONTENTS

LG Air Conditioner Technical Solution	3-4
Table of Symbols	6
Product Data	7-39
<i>Nomenclature</i>	8
<i>Pairing Table</i>	9
<i>Mechanical Specifications</i>	10-12
<i>General Data</i>	13-18
<i>Electrical Data</i>	19
<i>Functions, Controls, Options</i>	20-21
<i>Accessories</i>	22-24
<i>Outdoor Unit Dimensions</i>	25-27
<i>Outdoor Unit Center of Gravity / Corner Weight</i>	28
<i>Indoor Unit Dimensions</i>	29-32
<i>Air Flow, Temp. Distribution Graphs</i>	33-35
<i>Acoustic Data</i>	36-39
Performance Data	40-74
<i>Cooling Capacity</i>	41-48
<i>Maximum Cooling Capacity</i>	49-56
<i>Heating Capacity</i>	57-64
<i>Maximum Heating Capacity</i>	65-72
<i>Correction Factors</i>	73-74
<i>Check Selection</i>	74
Application Guidelines	75-86
<i>Indoor Unit Placement / Clearance Considerations</i>	76-77
<i>Outdoor Unit Placement / Clearance Considerations</i>	78-83
<i>Installing Outdoor Units Indoors</i>	84-86
Refrigerant Piping Design	87-100
<i>Refrigerant Flow Diagrams</i>	88-92
<i>Connection Limitations and System Layout</i>	93
<i>Additional Refrigerant Charge</i>	94
<i>Refrigerant Piping System Engineering</i>	95-100
Electrical	101-115
<i>General Guidelines</i>	102
<i>Wiring Diagrams</i>	103-111
<i>Power Supply / Power Wiring</i>	112
<i>Power Wiring / Communication Wiring</i>	113
<i>Controllers</i>	114-115
Limited Warranty	116

TABLE OF SYMBOLS

	Indicates that this appliance uses a flammable refrigerant. If the refrigerant leaks and is exposed to an external ignition source, there is a risk of fire.
⚠ DANGER	Indicates a hazardous situation that, if not avoided, WILL RESULT IN DEATH OR SERIOUS INJURY. ¹
⚠ WARNING	Indicates a hazardous situation that, if not avoided, COULD RESULT IN DEATH OR SERIOUS INJURY. ¹
⚠ CAUTION	Indicates a hazardous situation that, if not avoided, COULD RESULT IN MINOR OR MODERATE INJURY. ¹
NOTICE	Indicates information considered important, but not hazard-related; indicates situations that may result in equipment or property damage accidents. ¹
	This symbol indicates an action that should not be performed.

¹Signal words, symbols, and definitions taken from American National Standards Institute (ANSI) Z535.6. See <https://www.ansi.org/> for more information.



R32 Refrigerant



LG Electronic split system heating and air conditioning (HVAC) products now contain R32 refrigerant. While R32 refrigerant is slightly flammable, it has a higher efficiency, a lower Global Warming Potential (GWP) value, and is more environmentally friendly than R410A.

R32 Ozone Depletion Potential (ODP) Value: 0.



R32 Global Warming Potential (GWP) Value: 675.

The amount of refrigerant depends on outdoor unit to indoor unit configuration. All refrigerant piping system components (copper piping, joints, and other fittings) must be selected and installed to conform with Refrigeration Safety Regulation standards. Use LG Air Conditioner Technical Solution (LATS) Software to verify the refrigerant amount needed for each installation.

⚠ WARNING

- This HVAC system contains fluorinated greenhouse gases in the form of R32 refrigerant.  Do not leak refrigerant gas into the atmosphere.
- Only use R32 as the refrigerant in these HVAC systems. If other substances are added, it may cause an explosion.
- R32 refrigerant is slightly flammable. When handled properly, it does not leak. If the refrigerant leaks in the installation area and comes in contact with a flame, it may generate a fire and / or harmful gas.
- If a leak occurs, immediately turn off any combustion devices, ventilate the installation area, and contact the dealer / contractor where the HVAC unit was purchased.  Do not operate the unit until the refrigerant leaked is repaired.

⚠ CAUTION

- Piping wall thickness must comply with all applicable local, state, and federal regulations for the design pressures listed by the manufacturer.  Unapproved piping must not be used.
- To prevent piping from softening,  do not heat the piping more than necessary.

PRODUCT DATA

Nomenclature on page 8

Pairing Table on Page 9

Mechanical Specifications on page 10

General Data on page 13

Electrical Data on page 19

Functions, Controls, and Options on page 20

Accessories on page 22

Outdoor Unit Dimensions on page 25

Outdoor Unit Center of Gravity / Corner Weights on page 28

Indoor Unit Dimensions on page 29

Air Flow, Temperature Distribution Graphs on page 33

Acoustic Data on page 36



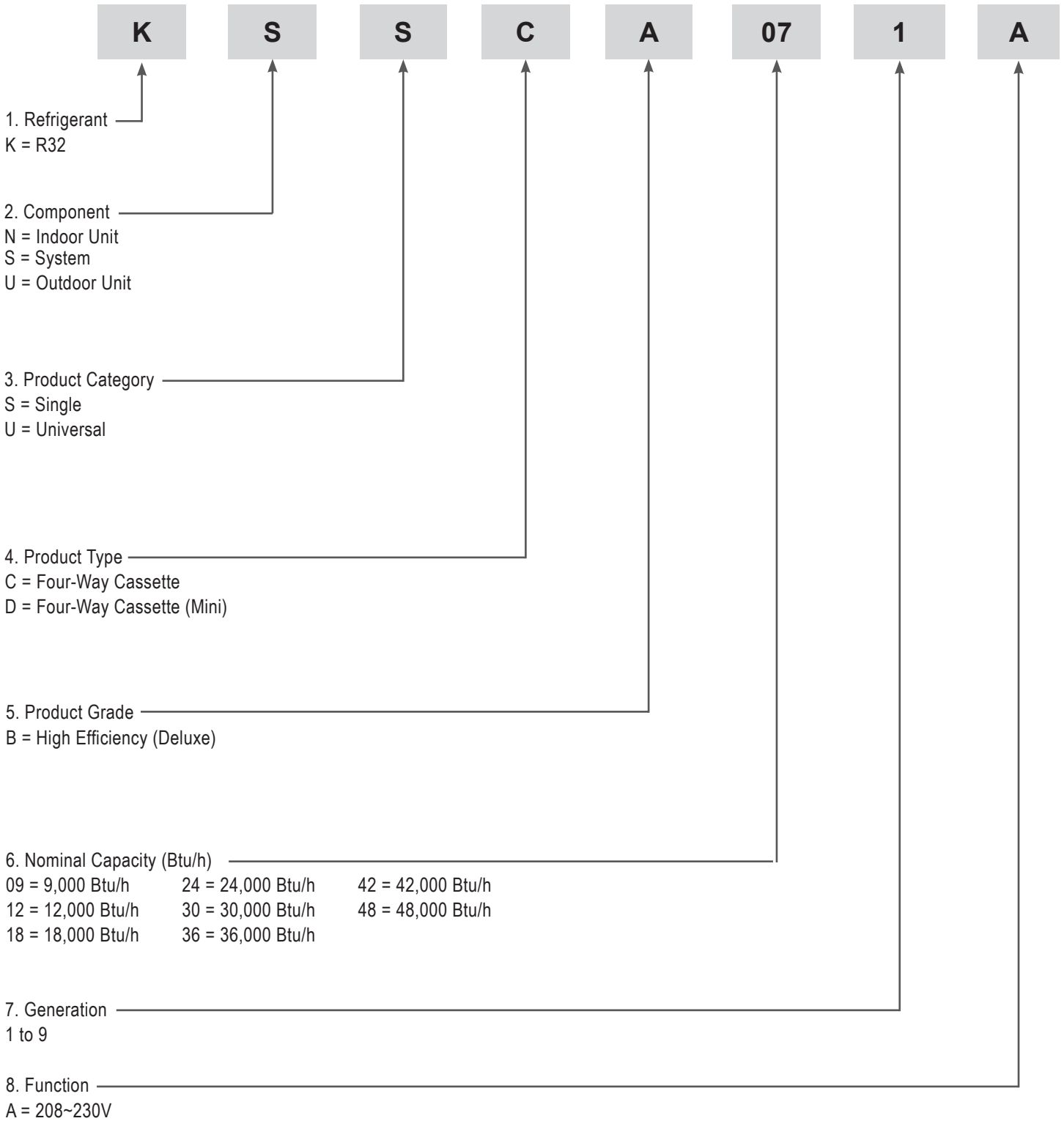











UNIT NOMENCLATURE



PAIRING TABLE

The following table shows the available outdoor and indoor unit, along with the factory provided controller.

Table 1: R32 Single Zone Four-Way Ceiling Cassette System Pairing Table

Outdoor Unit Model	Indoor Unit Model	Controller
<p>KUSXB091A KUSXB121A</p> 	<p>KNUDB091A KNUDB121A</p> 	<p>PQWRHQ0FDB</p> 
<p>KUSXB181A</p> 	<p>KNUDB181A</p> 	<p>PQWRHQ0FDB</p> 
<p>KUSXB241A</p> 	<p>KNSCB241A</p> 	<p>PWLSSB21H</p> 
<p>KUSXB301A</p> 	<p>KNSCB301A</p> 	<p>PWLSSB21H</p> 
<p>KUSXB361A KUSXB421A KUSXB481A</p> 	<p>KNSCB361A KNSCB421A KNSCB481A</p> 	<p>PWLSSB21H</p> 

Product Data

MECHANICAL SPECIFICATIONS

General

System

LG single zone four-way ceiling cassette system comprises of a single frame outdoor unit connected to a single indoor unit with a single refrigerant circuit. An LG single zone four-way ceiling cassette is a system that can operate in either cooling or heating mode. The system is capable of changing mode within a maximum time of three (3) minutes to ensure indoor temperature can be properly maintained. LG components are manufactured in a facility registered to ISO 9001 and ISO 14001, which is a set of standards applying to environmental protection set by the International organization for Standardization (ISO). The system components comply with CSA Standard for Safety and bear the CSA label. Wiring in these units are in accordance with the national Electrical Code (NEC). LG single zone four-way ceiling cassette systems have published performance ratings certified by AHRI (Air-Conditioning, Heating, and Refrigeration Institute) and are listed in the AHRI Standard 210 / 240 certified product directory.

9,000 and 12,000 Btu/h Ceiling Cassette Temperature Operating Ranges

- Operating ranges for outdoor units of 0°F to +118°F (DB) for cooling (Cooling range can be extended from 0°F down to -4°F using the Low Ambient Wind Baffle Kit [sold separately]); -4°F to +64°F (WB) for heating.
- Operating ranges for indoor units of 57°F to 77°F (WB) for cooling; 59°F to 81°F (DB) for heating.

Indoor unit temperature setting range of 65°F to 86°F (DB) for cooling; 61°F to 86°F (WB) for heating.

18,000, 24,000, 36,000, 42,000, and 48,000 Btu/h Ceiling Cassette Temperature Operating Ranges

- Operating ranges for outdoor units of 5°F to +118°F (DB) for cooling (Cooling range can be extended from 5°F down to -4°F using the Low Ambient Wind Baffle Kit [sold separately]); -4°F to +64°F (WB) for heating.
- Operating ranges for indoor units of 57°F to 77°F (WB) for cooling; 59°F to 81°F (DB) for heating.
- Indoor unit temperature setting range of 65°F to 86°F (DB) for cooling; 61°F to 86°F (WB) for heating.

Refrigerant System

The system is designed for use with R32 refrigerant, and consists of a single refrigeration circuit. The refrigeration circuit is pressure-tested at the factory and shipped with a holding charge of helium gas. The outdoor unit is provided with factory installed components, including a refrigerant strainer, accumulator, four-way reversing valve, electronic expansion valve (EEV), high and low side charging ports, service valves, and interconnecting piping. All refrigerant lines from the outdoor unit to the indoor unit are field-installed and must be insulated separately.

Electrical

The system was designed to operate using 208–230/60/1 power with

voltage variances of $\pm 10\%$ and includes overcurrent protection. The indoor unit is powered through the outdoor unit.

Controls

Indoor and outdoor units are factory wired with necessary electrical control components, printed circuit boards, thermistors, sensors, terminal blocks, and lugs for power wiring. Factory installed microprocessor controls in the outdoor unit and indoor unit perform functions to efficiently operate the single zone system, communicating via a 14 AWG four-conductor, stranded, shielded or unshielded (if shielded, must be grounded to the chassis at the outdoor unit only) power/transmission cable (and must comply with applicable local and national codes. Microprocessor-based algorithms provide component protection, soft-start capability, refrigeration system pressure, temperature, defrost, and ambient control. System can be operated through a handheld wireless controller supplied with the four-way ceiling cassette indoor unit.

Figure 2: R32 Single Zone Four-Way 3 x 3 Ceiling Cassette Systems (KSSCB361–481A).



Outdoor Unit

Sound Levels

The outdoor units have sound levels not exceeding 56 dB(A) tested in an anechoic chamber under ISO Standard 3745.

Casing / Frame

The outdoor condensing unit case is constructed from pre-coated metal (PCM) that has been tested in accordance with ASTM B-117 salt spray procedure for a minimum of 1,000 hours. Case has a removable panel to allow access to major internal components, and legs to secure the unit during installation.

Compressors

The 9,000 and 12,000 Btu/h outdoor units are equipped with one hermetically sealed, digitally controlled, inverter-driven rotary compressor to modulate capacity (modulation in 1 Hz increments). The 18,000 and 24,000 Btu/h outdoor units are equipped with one hermetically sealed, digitally controlled, inverter-driven scroll compressor to modulate capacity (modulation in 1 Hz increments). The 30,000 to 48,000 Btu/h outdoor units are equipped with one hermetically sealed, digitally controlled, inverter-driven R1 scroll compressor to modulate capacity (modulation in 1 Hz increments). All have Teflon coated bearings, overcurrent protection and vibration isolation are integrated with the compressor.

MECHANICAL SPECIFICATIONS

Frequency ranges for the outdoor units are:

9k and 12k Btu/h = 10 to 90 Hz Cooling; 10 to 100 Hz Heating
18k and 24k Btu/h = 15 to 80 Hz Cooling; 15 to 100 Hz Heating
30k Btu/h = 10 to 90 Hz Cooling; 10 to 100 Hz Heating
36k, 42k, and 48k Btu/h = 10 to 120 Hz Cooling; 10 to 135 Hz Heating

Coil

Heat pump outdoor unit coils are made of nonferrous louvered aluminum fins protected with an integral coil guard. The coil for each outdoor unit has a minimum of 14 fins per inch (FPI); heat exchanger has two rows. The coil fins have a factory applied corrosion resistant GoldFin™ material with hydrophilic coating tested in accordance with ASTM B-117 salt spray test procedure for a minimum of 1,000 hours. Coils are factory tested to a maximum allowable pressure of 626 psig

Fans and Motors

The 9,000 Btu/h (KUSXB091A), 12,000 Btu/h (KUSXB121A), 18,000 Btu/h (KUSXB181A), 24,000 Btu/h (KUSXB241A), and 30,000 Btu/h (KUSXB301A) outdoor units include one direct drive, variable speed axial / propeller type fan with a horizontal air discharge. The 36,000 Btu/h (KUSXB361A), 42,000 Btu/h (KUSXB421A), and 48,000 Btu/h (KUSXB481A) outdoor units include two fans.

Fan blades are made of Acrylonitrile Butadiene Styrene (ABS) material, and have a Brushless Digitally Controlled (BLDC) fan motor. The fan motor has inherent protection, permanently lubricated bearings, and variable speed with speeds from 150 to 850 rpm in Cooling, 300 to 850 rpm in Heating (9,000 and 12,000 Btu/h); 150 to 760 rpm in Cooling, 150 to 760 rpm in Heating (18,000 to 30,000 Btu/h); 150 to 750 rpm in Cooling, 250 to 750 rpm in Heating (36,000 to 48,000 Btu/h). Raised guards are provided to limit contact with moving parts.

Indoor Unit

Sound Levels

The indoor units have sound ratings no higher than 46 dB(A) as tested per ISO Standard 3745.

Casing / Frame

The indoor unit case is constructed coated metal designed to mount recessed recess in the ceiling, and has a surface-mounted concentric panel on the bottom of the unit. Cold surfaces are covered with a coated polystyrene insulating material. The case is provided with metal ears designed to support the unit weight on four corners. Ears have pre-punched holes designed to accept field-supplied all-thread rod hangers.

Unit has four supply air outlets and one return air inlet. The supply air outlet has four-directional slot diffusers, each equipped with an independent oscillating motorized guide vane to change airflow direction. A guide vane algorithm sequentially changes the predominant discharge airflow direction in counterclockwise pattern, or can be used to lock each guide vane independently in a field-adjusted fixed position. The four vanes can be individually adjusted from the wired

remote controller to customize the airflow pattern for the conditioned space. A setting in the cooling and heating modes can cycle the vanes up and down for uniform / random air distribution.

Panels are sold as separate required accessories. The four-way panel is white acrylonitrile butadiene styrene (ABS) polymeric resin with a tapered trim edge.

Coil

Indoor unit coils are factory built and are comprised of aluminum fins mechanically bonded to grooved-design copper tubes with slit coil fins.

The 9,000 Btu/h (KNUDB091A), 12,000 Btu/h (KNUDB121A), 18,000 Btu/h (KNUDB181A), and 24,000 Btu/h (KNSCB241A) indoor units have two (2) rows of coils, 8 columns and 18 fins per inch. The 30,000 Btu/h (KNSCB301A), 36,000 Btu/h (KNSCB361A) indoor units have three (3) rows of coils, 12 columns, and 21 fins per inch. The 42,000 Btu/h (KNSCB421A), and 48,000 Btu/h (KNSCB481A) indoor units have three (3) rows, 18 columns, and 22 fins per inch. All indoor unit coils have been pressure tested to a maximum allowable pressure of 626 psig at the factory. Each unit is provided with a factory installed condensate drain pan below the coil.

Fans and Motors

All of the indoor units have a single, direct-drive, turbo fan manufactured of high-strength ABS HT-700 polymeric resin; the fans are statically and dynamically balanced. The fan motor is brushless digitally controlled (BLDC) with permanently lubricated and sealed ball bearings. The fan motor includes thermal, overcurrent and low RPM protection. The fan / motor assembly is mounted on vibration-attenuating rubber grommets.

Fan speed is controlled using a microprocessor-based, direct-digital control algorithm that provides pre-programmed, field-selectable fixed or auto fan speeds in the Heating and Cooling modes. The fan speeds can be field adjusted between low, medium, and high. Auto setting adjusts the fan speed based on the difference between the controller set-point and space temperature.

Microprocessor Controls

A temperature thermistor is factory-mounted in the return air stream. All unit operation parameters, excluding the unit operating schedule, are stored in non-volatile memory resident on the unit microprocessor. Operating schedules are stored in select models of the optional, wall-mounted, local, or central controller.

Figure 3: R32 Single Zone Four-Way 2 x 2 Ceiling Cassette Systems (KSUDB091 and 121A).



MECHANICAL SPECIFICATIONS

For heat pump systems, heated or cooled air delivery is dependent upon outdoor unit operating mode. In Heating mode, the microprocessor control will activate indoor unit operation when the indoor room temperature falls below setpoint temperature. At which point, a signal is sent to the outdoor unit to begin the heating cycle. The indoor unit fan operation is delayed until coil pipe temperature reaches 76°F. Significant airflow is generated when pipe temperature reaches 80°F. The unit is equipped with an infrared receiver designed to communicate with an LG wireless remote controller. In lieu of wireless remote or factory return air thermistor, screw terminals on the microprocessor circuit board accommodate various models of wall-mounted local controllers and/or a wall-mounted remote temperature sensor. The unit microprocessor is capable of accepting space temperature readings concurrently or individually from either:

1. Wall-mounted wired controller(s)
2. Factory mounted return air thermistor or the optional wall mounted wired remote temperature sensor.

The indoor units are Wi-Fi compatible with the addition of an LG Wi-Fi module accessory, and can be controlled by LG's ThinQ™ app on a smart device. A field-supplied Wi-Fi network and smart device are required. The ThinQ app is free, and is available for Android™ and iOS. (Android is a trademark of Google LLC.)

Architectural Panel / Air Filter — TP-B Frame for 3'x3' 24,000 Btu/h Indoor Units; TM-A Frame for 3'x3' 36,000 Btu/h, 42,000 Btu/h, and 48,000 Btu/h Indoor Units

The unit case allows access to hanger rods and the inspection of piping through corner access panels on the architectural panel. The optional auto-elevating panel kit is designed to provide motorized ascent/descent of the return air panel/pre-filter assembly a distance of up to 12 feet allowing easy access to remove and clean the filter.

The kit consists of two lifting mechanisms comprised of an electric motor driven winch with four (4) braided steel lifting cables. The winch kit is mounted behind the panel and is not visible during normal unit operation. The auto-elevating return air panel appearance and finish matches that of the architectural panel on similar indoor unit models equipped with the standard hinged filter panels. The auto-elevating panel control algorithm accepts up, down, and stop control commands from either a wall-mounted or the lift remote controller. The algorithm does not permit the lowering of the panel while the indoor unit fan is operating. The pair of winch controllers work in unison to keep the return air panel level during lift and descent operations and will automatically stop the descent of the return air panel/filter if contact is made with any obstacle.

Airflow Guide Vanes — TP-B Frame for 3'x3' 24,000 Btu/h Indoor Units; TM-A Frame for 3'x3' 36,000 Btu/h, 42,000 Btu/h, and 48,000 Btu/h Indoor Units

The architectural panel has four-directional slot diffusers each equipped with independent dual-vane oscillating motorized guide vanes designed to change the angle airflow is discharged. Discharge range of motion is 10° to 85° in an up/down direction. A

control algorithm provides the capability of locking each guide vane independently in a field adjusted fixed position. Guide vanes provide airflow in all directions. The ends of each vane are tapered to provide airflow to the space in the direction of the four corners of the architectural panel.

Filters

Return air is filtered with a factory-supplied, removable, washable MERV 6 rated prefilter accessible from the bottom of the unit. For 2' x 2' cassettes the removable washable filter size is 14" x 14" x 1". For 3' x 3' cassettes the removable washable filter size is 20.5" x 20.5" x 1". An optional Premium Panel accessory with the PTAHMP0 Air Purification Kit is also available for the 3' x 3' cassettes.

Ventilation Air — TR Frame for 2'x2' 9,000 Btu/h and 12,000 Btu/h Indoor Units; TQ Frame for 2'x2' 18,000 Btu/h Indoor Units

The case has a factory designated cutout for the connection of a field-supplied outside air duct. An optional flange kit is available from LG.

Ventilation Air — TP-B Frame for 3'x3' 24,000 Btu/h Indoor Units; TM-A Frame for 3'x3' 36,000 Btu/h, 42,000 Btu/h, and 48,000 Btu/h Indoor Units

The case has a factory designated cutout for the connection of a field-supplied outside air duct. LG offers two flange kits.

Supply Air Branch Duct Connections

Factory designated cutouts are marked on the unit case. Branch ducts provide the designer with the ability to duct up to 1/2 the unit airflow capacity to adjacent spaces. The adjacent space must be in the room where the ceiling cassette is installed. It cannot be branched to another room.

Refrigerant Leak Detector

The single zone cassette unit has a built-in leak detector sensor to detect any refrigerant leaks.

Shut-off Valve

LG single port shutoff valve (PRHPZ010A; sold separately) is available as an accessory for the cassette unit.

Condensate Lift / Pump

The indoor unit is provided with a factory installed and wired condensate lift/pump capable of providing a maximum 27-9/16 inch (9,000, 12,000, and 18,000 Btu/h) or 31-1/2 inch (24,000, 36,000, 42,000, and 48,000 Btu/h) lift from the bottom surface of the unit. Drain pump has a safety switch to shut off the indoor unit if the condensate rises too high in the drain pan.

Condensate Drain Pan

The condensate drain pan is constructed of EPS (expandable polystyrene resin).

GENERAL DATA

Table 2: R32 Single Zone Four-Way 2x2 Cassette System Specifications.

System (Model) (Indoor Unit / Outdoor Unit)	KSUDB091A (KNUDB091A / KUSXB091A)	KSUDB121A (KNUDB121A / KUSXB121A)	KSUDB181A (KNUDB181A / KUSXB181A)
Grille Model No.	PT-QAGW0	PT-QAGW0	PT-QAGW0
Cooling Capacity (Min/Rated/Max) (Btu/h)	3,400~9,000~9,900	3,600~11,100~12,400	7,200~18,000 ~23,000
Cooling Power Input ¹ (Min/Rated/Max) (kW)	0.18 ~0.65~0.83	0.19~0.85~1.10	0.46~1.385~2.50
EER2 (@95°F)	13.90	13.00	13.00
SEER2	22.20	21.5	20.5
Heating Capacity (Min/Rated/Max) (Btu/h)	2,800~11,000~15,000	4,400~14,000~16,500	7,000~20,000~24,000
Heating Power Input ¹ (Min/Rated/Max) (kW)	0.13~0.81~1.35	0.15~1.210 ~1.62	0.50~1.776~2.40
COP (@47°F)	3.96	3.40	3.30
HSPF2	10.00	10.1	9.5
<i>Rated Low Heating Capacity (Btu/h)</i>			
Outdoor 17°F (WB)/Indoor 70°F (DB)	6,400	8,700	13,000
Low COP (@17°F)	2.86	2.70	2.60
<i>Maximum Heating Capacity (Btu/h)</i>			
Outdoor 17°F (WB)/Indoor 70°F (DB)	11,600	12,700	20,800
Outdoor 5°F (WB)/Indoor 70°F (DB)	10,400	10,700	19,000
Outdoor -4 °F (WB)/Indoor 70°F (DB)	9,300	9,800	17,600
ENERGY STAR / Cold Climate	Yes / Yes	Yes / Yes	Yes / Yes
Power Supply (To Outdoor Unit; V / Hz / Ø)	208-230 / 60 / 1		
Power Supply Wiring (Outdoor Unit) (No. x AWG) ²	3 x 12	3 x 12	3 x 12
Power Wiring / Comm. Wiring (ODU to IDU) (No. x AWG) ²	3 x 14 / 2 x 18	3 x 14 / 2 x 18	3 x 14 / 2 x 18
<i>Indoor Unit Data</i>			
Operating Range	Cooling (°F WB)	57 to 77	
	Heating (°F DB)	59 to 81	
Temperature Setting Range	Cooling (°F)	65 to 86	
	Heating (°F)	61 to 86	
Sound Pressure ³ dB(A) (H/M/L)	Cooling	36 / 33 / 30	41 / 39 / 36
	Heating	36 / 33 / 30	41 / 39 / 36
Net Dimensions (W x H x D) (in.)	22-7/16 x 8-7/16 x 22-7/16	22-7/16 x 8-7/16 x 22-7/16	22-7/16 x 10-3/32 x 22-7/16
Shipping Dimensions (W x H x D) (in.)	26-1/4 x 11-7/32 x 25-7/16	26-1/4 x 11-7/32 x 25-7/16	26-1/4 x 12-7/8 x 25-7/16
Net / Shipping Weight (lbs.)	28.4 / 34	28.4 / 34	30.9 / 37
Grille Dimensions (W x H x D) (in.)	24-13/32 x 1-3/8 x 24-13/32	24-13/32 x 1-3/8 x 24-13/32	26-1/4 x 12-7/8 x 25-7/16
Grille Net / Shipping Weight (lbs.)	6.3 / 8.6	6.3 / 8.6	6.3 / 8.6
Fan Type x Qty.	Turbo x 1	Turbo x 1	Turbo x 1
Fan Motor Output (W) x Qty.	43 x 1	43 x 1	43 x 1
Fan Motor / Drive	Brushless Digitally Controlled/Direct		
Airflow Rate (H/M/L (CFM) (Cooling / Heating)	300 / 265 / 230	335 / 283 / 247	459 / 424 / 388
Dehumidification Rate (pts./hr.)	1.5	2.5	3.1

EEV: Electronic Expansion Valve IDU: Indoor Unit ODU: Outdoor Unit
 This data is rated 0 ft above sea level with 24.6 of refrigerant line per indoor unit and a 0 ft level difference outdoor and indoor units.
 Cooling capacity rating obtained with air entering the indoor unit at 80°F dry bulb (DB) and 67°F wet bulb (WB) and outdoor ambient conditions of 95°F dry bulb (DB) and 75°F wet bulb (WB).
 Heating capacity rating obtained with air entering the indoor unit at 70°F dry bulb (DB) and 59°F wet bulb (WB) and outdoor ambient conditions of 47°F dry bulb (DB) and 43°F wet bulb (WB).

¹Power Input is rated at high speed.
²All power supply wiring to the outdoor unit is field supplied, solid or stranded. The power wiring and the communication wiring from the outdoor unit to the indoor unit is field supplied and must be stranded, shielded or unshielded (if shielded, it must be grounded to the chassis of the outdoor unit only). All wiring must comply with applicable local and national codes.
³Sound Pressure levels are tested in an anechoic chamber under ISO Standard 3745.



GENERAL DATA

Table 3: R32 Single-Zone Four-Way 2x2 Cassette System Specifications, continued.

System (Model) (Indoor Unit / Outdoor Unit)		KSUDB091A (KNUDB091A / KUSXB091A)	KSUDB121A (KNUDB121A / KUSXB121A)	KSUDB181A (KNUDB181A / KUSXB181A)
<i>Outdoor Unit Data</i>				
Operating Range ¹	Cooling (°F DB)	5 to +118 ¹		
	Heating (°F WB)	-4 to +64		
Sound Pressure ² dB(A)	Cooling	47	49	48
	Heating	51	52	52
Max. External Static Pressure (in. w.g.)		0.04	0.04	0.04
Net Dimensions (W x H x D) (in.)		30-5/16 x 21-15/32 x 11-11/32	30-5/16 x 21-15/32 x 11-11/32	37-13/32 x 32-27/32 x 13
Shipping Dimensions (W x H x D) (in.)		36-7/32 x 23-1/32 x 15-9/32	36-7/32 x 23-1/32 x 15-9/32	44-7/8 x 36-5/32 x 18-5/32
Net / Shipping Weight (lbs.)		75 / 79.4	75 / 79.4	136 / 154.3
Exterior Color Codes		Munsell 2.5Y 7.5/1 (RAL 7044)		
Fan Type x Qty.		Axial x 1	Axial x 1	Axial x 1
Fan Motor Output (W) x Qty.		43 x 1	43 x 1	124 x 1
Fan Motor / Drive		Brushless Digitally Controlled / Direct		
Airflow Rate Max. (CFM)		988	988	2,048
Compressor (Type x Qty.)		Rotary x 1	Rotary x 1	Twin Rotary x 1
<i>Heat Exchanger</i>				
Material and Fin Coating		Copper Tube / Aluminum Fin (Gold Fin™ Coating on Outdoor Unit Coil; N/A on Indoor Unit Coil)		
Rows / Columns / Fin per inch x Qty.	Outdoor Unit Coil	(2 x 24 x 14) x 1	(2 x 24 x 14) x 1	(2 x 38 x 14) x 1
	Indoor Unit Coil	(2 x 8 x 18) x 1	(2 x 8 x 18) x 1	(2 x 8 x 18) x 1
<i>Refrigerant</i>				
Type ³ / Control		R32 / EEV		
Pre-Charge (oz.)		38.8	38.8	67
Additional Charge (oz./ft.)		0.22	0.22	0.38
<i>Piping</i>				
Liquid (in.)	Connection / Pipe Size	1/4 Flare / 1/4 Flare	1/4 Flare / 1/4 Flare	1/4 Flare / 3/8 Flare
Vapor (in.)	Connection / Pipe Size	3/8 Flare / 3/8 Flare	3/8 Flare / 3/8 Flare	1/2 Flare / 5/8 Flare
Condensation Line (O.D., I.D., in.)		1-1/4 / 1	1-1/4 / 1	1-1/4 / 1
Pipe Length ⁴ (Minimum/Maximum) (ft.)		16.4 / 65.6	16.4 / 65.6	16.4 / 164
Piping Length ⁴ (no add'l refrigerant, ft.)		24.6	24.6	24.6
Max Elevation Difference (ft.)		49.2	49.2	98.4

EEV: Electronic Expansion Valve IDU: Indoor Unit ODU: Outdoor Unit
This data is rated 0 ft above sea level with 24.6 of refrigerant line per indoor unit and a 0 ft level difference outdoor and indoor units.

Cooling capacity rating obtained with air entering the indoor unit at 80°F dry bulb (DB) and 67°F wet bulb (WB) and outdoor ambient conditions of 95°F dry bulb (DB) and 75°F wet bulb (WB).
Heating capacity rating obtained with air entering the indoor unit at 70°F dry bulb (DB) and 59°F wet bulb (WB) and outdoor ambient conditions of 47°F dry bulb (DB) and 43°F wet bulb (WB).

¹Optional Low Ambient Wind Baffle Kit allows operation down to -4°F in cooling mode.

²Sound Pressure levels are tested in an anechoic chamber under ISO Standard 3745.

³Take appropriate actions at the end of HVAC equipment life to recover, recycle, reclaim or destroy R32 refrigerant according to applicable regulations (40 CFR Part 82, Subpart F) under section 608 of CAA.

⁴Piping lengths are equivalent.

GENERAL DATA

Table 4: R32 Single-Zone Four-Way 3x3 Cassette System Specifications.

System (Model) (Indoor Unit / Outdoor Unit)	KSSCB241A (KNSCB241A / KUSXB241A)	KSSCB301A (KNSCB301A / KUSXB301A)	KSSCB361A (KNSCB361A / KUSXB361A)
Grille Model No.	PT-AAGW0	PT-AAGW0	PT-AAGW0
Cooling Capacity (Min/Rated/Max) (Btu/h)	9,300~23,000~29,000	12,000~30,000~35,000	14,400~36,000~42,000
Cooling Power Input ¹ (Min/Rated/Max) (kW)	0.59~1.769~3.10	0.80~2.480~3.60	0.72~2.77~3.90
EER2 (@95°F)	13.00	12.10	13.00
SEER2	21.0	21.0	22.0
Heating Capacity (Min/Rated/Max) (Btu/h)	10,000~27,000~30,000	14,000~33,000~37,000	16,000~40,000~42,200
Heating Power Input ¹ (Min/Rated/Max) (kW)	0.55~2.20~3.10	0.80~2.545~4.00	0.80~2.75~4.05
COP (@47°F)	3.60	3.80	4.26
HSPF2	10.2	10.0	10.3
<i>Rated Low Heating Capacity (Btu/h)</i>			
Outdoor 17°F (WB)/Indoor 70°F (DB)	17,000	21,000	24,800
Low COP (@17°F)	2.90	3.08	3.00
<i>Maximum Heating Capacity (Btu/h)</i>			
Outdoor 17°F (WB)/Indoor 70°F (DB)	25,000	33,800	38,000
Outdoor 5°F (WB)/Indoor 70°F (DB)	23,000	32,000	35,000
Outdoor -4 °F (WB)/Indoor 70°F (DB)	21,000	27,000	31,450
ENERGY STAR / Cold Climate	Yes / Yes	Yes / Yes	Yes / Yes
Power Supply (To Outdoor Unit; V / Hz / Ø)	208-230 / 60 / 1		
Power Supply Wiring (Outdoor Unit) (No. x AWG) ²	3 x 12	3 x 10	3 x 10
Power Wiring / Comm. Wiring (ODU to IDU) (No. x AWG) ²	3 x 14 / 2 x 18	3 x 14 / 2 x 18	3 x 14 / 2 x 18
<i>Indoor Unit Data</i>			
Operating Range	Cooling (°F WB)	57 to 77	
	Heating (°F DB)	59 to 81	
Temperature Setting Range	Cooling (°F)	65 to 86	
	Heating (°F)	61 to 86	
Sound Pressure ³ dB(A) (H/M/L)	Cooling	40 / 37 / 35	42 / 41 / 40
	Heating	40 / 37 / 35	42 / 41 / 40
Net Dimensions (W x H x D) (in.)	33-1/16 x 8-1/32 x 33-1/16	33-1/16 x 11-5/16 x 33-1/16	33-1/16 x 11-5/16 x 33-1/16
Shipping Dimensions (W x H x D) (in.)	36-5/16 x 11-3/16 x 36-3/32	36-5/16 x 14-3/16 x 36-3/32	36-5/16 x 14-3/16 x 36-3/32
Net / Shipping Weight (lbs.)	45.9 / 56	56.4 / 70.5	56.4 / 70.5
Grille Dimensions (W x H x D) (in.)	37-3/8 x 1-3/8 x 37-3/8	37-3/8 x 1-3/8 x 37-3/8	37-3/8 x 1-3/8 x 37-3/8
Grille Net / Shipping Weight (lbs.)	16 / 21	16 / 21	16 / 21
Fan Type x Qty.	Turbo x 1	Turbo x 1	Turbo x 1
Fan Motor Output (W) x Qty.	136 x 1	146 x 1	146 x 1
Fan Motor / Drive	Brushless Digitally Controlled/Direct		
Airflow Rate (Max.)/H/M/L (CFM)	794 / 671 / 600 / 530	840 / 755 / 670	971 / 883 / 794
Dehumidification Rate (pts./hr.)	3.8	5.4	7.8

EEV: Electronic Expansion Valve IDU: Indoor Unit ODU: Outdoor Unit

This data is rated 0 ft above sea level with 24.6 of refrigerant line per indoor unit and a 0 ft level difference outdoor and indoor units.

Cooling capacity rating obtained with air entering the indoor unit at 80°F dry bulb (DB) and 67°F wet bulb (WB) and outdoor ambient conditions of 95°F dry bulb (DB) and 75°F wet bulb (WB).

Heating capacity rating obtained with air entering the indoor unit at 70°F dry bulb (DB) and 59°F wet bulb (WB) and outdoor ambient conditions of 47°F dry bulb (DB) and 43°F wet bulb (WB).

¹Power Input is rated at high speed.

²All power supply wiring to the outdoor unit is field supplied, solid or stranded. The power wiring and the communication wiring from the outdoor unit to the indoor unit is field supplied and must be stranded, shielded or unshielded (if shielded, it must be grounded to the chassis of the outdoor unit only). All wiring must comply with applicable local and national codes.

³Sound Pressure levels are tested in an anechoic chamber under ISO Standard 3745.

GENERAL DATA

Table 5: R32 Single-Zone Four-Way 3x3 Cassette Specifications, continued.

System (Model) (Indoor Unit / Outdoor Unit)		KSSCB241A (KNSCB241A / KUSXB241A)	KSSCB301A (KNSCB301A / KUSXB301A)	KSSCB361A (KNSCB361A / KUSXB361A)
<i>Outdoor Unit Data</i>				
Operating Range ¹	Cooling (°F DB)	5 to +118 ¹		
	Heating (°F WB)	-4 to +64		
Sound Pressure ² dB(A)	Cooling	48	52	52
	Heating	52	54	54
Max. External Static Pressure (in. w.g.)		0.04	0.04	0.04
Net Dimensions (W x H x D) (in.)		37-13/32 x 32-27/32 x 13	37-13/32 x 32-27/32 x 13	37-13/32 x 54-11/32 x 13.0
Shipping Dimensions (W x H x D) (in.)		44-7/8 x 36-5/32 x 18-5/32	44-7/8 x 36-5/32 x 18-5/32	45-5/32 x 57-19/32 x 18-5/32
Net / Shipping Weight (lbs.)		136 / 154.3	141.1 / 159.4	190.2 / 214.3
Exterior Color Codes		Munsell 2.5Y 7.5/1 (RAL 7044)		Munsell 2.5Y 7.5/1 (RAL 7044)
Fan Type x Qty.		Axial x 1	Axial x 1	Axial x 2
Fan Motor Output (W) x Qty.		124 x 1	124 x 1	124 x 2
Fan Motor / Drive		Brushless Digitally Controlled / Direct		
Airflow Rate Max. (CFM)		2,048	2,048	1,942 x 2
Compressor (Type x Qty.)		Twin Rotary x 1	R1 Scroll x 1	R1 Scroll x 1
<i>Heat Exchanger</i>				
Material and Fin Coating		Copper Tube / Aluminum Fin (Gold Fin™ Coating on Outdoor Unit Coil; N/A on Indoor Unit Coil)		
Rows / Columns / Fin per inch x Qty.	Outdoor Unit Coil	(2 x 38 x 14) x 1	(2 x 38 x 14) x 1	(2 x 64 x 14) x 1
	Indoor Unit Coil	(2 x 8 x 18) x 1	(3 x 12 x 21) x 1	(3 x 12 x 21) x 1
<i>Refrigerant</i>				
Type ³ / Control		R32 / EEV		
Pre-Charge (oz.)		67	67	106
Additional Charge (oz./ft.)		0.38	0.38	0.43
<i>Piping</i>				
Liquid (in.)	Connection / Pipe Size	3/8 Flare / 3/8 Flare	3/8 Flare / 3/8 Flare	3/8 Flare / 3/8 Flare
Vapor (in.)	Connection / Pipe Size	5/8 Flare / 5/8 Flare	5/8 Flare / 5/8 Flare	5/8 Flare / 5/8 Flare
Condensation Line (O.D., I.D., in.)		1-1/4 / 1	1-1/4 / 1	1-1/4 / 1
Pipe Length ⁴ (Minimum/Maximum) (ft.)		16.4 / 164	16.4 / 164	16.4 / 246
Piping Length ⁴ (no add'l refrigerant, ft.)		24.6	24.6	24.6
Max Elevation Difference (ft.)		98.4	98.4	98.4

EEV: Electronic Expansion Valve IDU: Indoor Unit ODU: Outdoor Unit

This data is rated 0 ft above sea level with 24.6 of refrigerant line per indoor unit and a 0 ft level difference outdoor and indoor units.

Cooling capacity rating obtained with air entering the indoor unit at 80°F dry bulb (DB) and 67°F wet bulb (WB) and outdoor ambient conditions of 95°F dry bulb (DB) and 75°F wet bulb (WB).
Heating capacity rating obtained with air entering the indoor unit at 70°F dry bulb (DB) and 59°F wet bulb (WB) and outdoor ambient conditions of 47°F dry bulb (DB) and 43°F wet bulb (WB).

¹Optional Low Ambient Wind Baffle Kit allows operation down to -4°F in cooling mode.

²Sound Pressure levels are tested in an anechoic chamber under ISO Standard 3745.

³Take appropriate actions at the end of HVAC equipment life to recover, recycle, reclaim or destroy R32 refrigerant according to applicable regulations (40 CFR Part 82, Subpart F) under section 608 of CAA.

⁴Piping lengths are equivalent.

GENERAL DATA

Table 6: R32 Single-Zone Four-Way 3x3 Cassette Specifications.

System (Model) (Indoor Unit / Outdoor Unit)	KSSCB421A (KNSCB421A / KUSXB421A)	KSSCB481A (KNSCB481A / KUSXB481A)
Grille Model No.	PT-AAGW0	PT-AAGW0
Cooling Capacity (Min/Rated/Max) (Btu/h)	16,800~42,000~48,700	19,200~48,000~53,000
Cooling Power Input ¹ (Min/Rated/Max) (kW)	1.16~3.18~5.50	1.15~3.97~5.92
EER2 (@95°F)	13.2	12.10
SEER2	21.0	21.20
Heating Capacity (Min/Rated/Max) (Btu/h)	18,800~48,000~49,800	19,000~51,000~54,000
Heating Power Input ¹ (Min/Rated/Max) (kW)	1.17~3.35~4.93	1.45~3.77~5.37
COP (@47°F)	4.20	3.96
HSPF2	10.8	10.40
<i>Rated Low Heating Capacity (Btu/h)</i>		
Outdoor 17°F (WB)/Indoor 70°F (DB)	30,000	32,200
Low COP (@17°F)	3.10	3.06
<i>Maximum Heating Capacity (Btu/h)</i>		
Outdoor 17°F (WB)/Indoor 70°F (DB)	41,500	41,500
Outdoor 5°F (WB)/Indoor 70°F (DB)	40,000	40,000
Outdoor -4 °F (WB)/Indoor 70°F (DB)	35,200	36,960
ENERGY STAR / Cold Climate	Yes / Yes	Yes / Yes
Power Supply (To Outdoor Unit; V / Hz / Ø)	208-230 / 60 / 1	
Power Supply Wiring (Outdoor Unit) (No. x AWG) ²	3 x 10	3 x 10
Power Wiring / Comm. Wiring (ODU to IDU) (No. x AWG) ²	3 x 14 / 2 x 18	3 x 14 / 2 x 18
<i>Indoor Unit Data</i>		
Operating Range	Cooling (°F WB)	57 to 77
	Heating (°F DB)	59 to 81
Temperature Setting Range	Cooling (°F)	65 to 86
	Heating (°F)	61 to 86
Sound Pressure ³ dB(A) (H/M/L)	Cooling	46 / 43 / 41
	Heating	46 / 43 / 41
Net Dimensions (W x H x D) (in.)	33-1/16 x 11-11/32 x 33-1/16	33-1/16 x 11-11/32 x 33-1/16
Shipping Dimensions (W x H x D) (in.)	36-5/16 x 14-3/16 x 36-3/32	36-5/16 x 14-3/16 x 36-3/32
Indoor Unit Net / Shipping Weight (lbs.)	60.2 / 74.3	60.2 / 74.3
Grille Dimensions (W x H x D) (in.)	37-3/8 x 1-3/8 x 37-3/8	37-3/8 x 1-3/8 x 37-3/8
Grille Net / Shipping Weight (lbs.)	16 / 21	16 / 21
Fan Type x Qty.	Turbo x 1	Turbo x 1
Fan Motor Output (W) x Qty.	166 x 1	166 x 1
Fan Motor / Drive	Brushless Digitally Controlled/Direct	
Airflow Rate H/M/L (CFM)	1,130 / 953 / 812	1,130 / 953 / 812
Dehumidification Rate (pts./hr.)	8.4	10.7

EEV: Electronic Expansion Valve IDU: Indoor Unit ODU: Outdoor Unit

This data is rated 0 ft above sea level with 24.6 of refrigerant line per indoor unit and a 0 ft level difference outdoor and indoor units.

Cooling capacity rating obtained with air entering the indoor unit at 80°F dry bulb (DB) and 67°F wet bulb (WB) and outdoor ambient conditions of 95°F dry bulb (DB) and 75°F wet bulb (WB).

Heating capacity rating obtained with air entering the indoor unit at 70°F dry bulb (DB) and 59°F wet bulb (WB) and outdoor ambient conditions of 47°F dry bulb (DB) and 43°F wet bulb (WB).

¹Power Input is rated at high speed.

²All power supply wiring to the outdoor unit is field supplied, solid or stranded. The power wiring and the communication wiring from the outdoor unit to the indoor unit is field supplied and must be stranded, shielded or unshielded (if shielded, it must be grounded to the chassis of the outdoor unit only). All wiring must comply with applicable local and national codes.

³Sound Pressure levels are tested in an anechoic chamber under ISO Standard 3745.

GENERAL DATA

Table 7: R32 Single-Zone Four-Way 3x3 Cassette Specifications, continued.

System (Model) (Indoor Unit / Outdoor Unit)		KSSCB421A (KNSCB421A / KUSXB421A)	KSSCB481A (KNSCB481A / KUSXB481A)
<i>Outdoor Unit Data</i>			
Operating Range ¹	Cooling (°F DB)	5 to +118 ¹	
	Heating (°F WB)	-4 to +64	
Sound Pressure ² dB(A)	Cooling	54	54
	Heating	56	56
Max. External Static Pressure (in. w.g.)		0.04	0.04
Net Dimensions (W x H x D) (in.)		37-13/32 x 54-11/32 x 13	37-13/32 x 54-11/32 x 13
Shipping Dimensions (W x H x D) (in.)		45-5/32 x 57-19/32 x 18-5/32	45-5/32 x 57-19/32 x 18-5/32
Net / Shipping Weight (lbs.)		190.2 / 214.3	190.2 / 214.3
Exterior Color Codes Munsell 2.5Y 7.5/1 (RAL 7044)			
Fan Type x Qty.		Axial x 2	Axial x 2
Fan Motor Output (W) x Qty.		124 x 2	124 x 2
Fan Motor / Drive Brushless Digitally Controlled / Direct			
Airflow Rate Max. (CFM)		1,942 x 2	1,942 x 2
Compressor (Type x Qty.)		R1 Scroll x 1	R1 Scroll x 1
<i>Heat Exchanger</i>			
Material and Fin Coating		Copper Tube / Aluminum Fin (Gold Fin™ Coating on Outdoor Unit Coil; N/A on Indoor Unit Coil)	
Rows / Columns / Fin per inch x Qty.	Outdoor Unit Coil	(2 x 64 x 14) x 1	(2 x 64 x 14) x 1
	Indoor Unit Coil	(3 x 18 x 22) x 1	(3 x 18 x 22) x 1
<i>Refrigerant</i>			
Type ³ / Control		R32 / EEV	
Pre-Charge (oz.)		106	106
Additional Charge (oz./ft.)		0.43	0.43
<i>Piping</i>			
Liquid (in.)	Connection / Pipe Size	3/8 Flare / 3/8 Flare	3/8 Flare / 3/8 Flare
Vapor (in.)	Connection / Pipe Size	5/8 Flare / 5/8 Flare	5/8 Flare / 5/8 Flare
Condensation Line (O.D., I.D., in.)		1-1/4 / 1	1-1/4 / 1
Pipe Length ⁴ (Minimum/Maximum) (ft.)		16.4 / 246	16.4 / 246
Piping Length ⁴ (no add'l refrigerant, ft.)		24.6	24.6
Max Elevation Difference (ft.)		98.4	98.4

EEV: Electronic Expansion Valve IDU: Indoor Unit ODU: Outdoor Unit
 This data is rated 0 ft above sea level with 24.6 of refrigerant line per indoor unit and a 0 ft level difference outdoor and indoor units.
 Cooling capacity rating obtained with air entering the indoor unit at 80°F dry bulb (DB) and 67°F wet bulb (WB) and outdoor ambient conditions of 95°F dry bulb (DB) and 75°F wet bulb (WB).
 Heating capacity rating obtained with air entering the indoor unit at 70°F dry bulb (DB) and 59°F wet bulb (WB) and outdoor ambient conditions of 47°F dry bulb (DB) and 43°F wet bulb (WB).

¹Optional Low Ambient Wind Baffle Kit allows operation down to -4°F in cooling mode.
²Sound Pressure levels are tested in an anechoic chamber under ISO Standard 3745.
³Take appropriate actions at the end of HVAC equipment life to recover, recycle, reclaim or destroy R32 refrigerant according to applicable regulations (40 CFR Part 82, Subpart F) under section 608 of CAA.
⁴Piping lengths are equivalent.

ELECTRICAL DATA

Table 8: R32 Single-Zone Four-Way Cassette Electrical Data Table.

Nominal Tons	Unit Model No.	Phase	Hertz	Voltage	Voltage Range (Min. to Max.)	MCA	MOP	LRA	Compressor Quantity	Compressor Motor RLA (Cooling)	Condenser Fan Motor(s)	
											Condenser Fan Qty.	Condenser Fan Motor FLA
<i>2x2 Cassette</i>												
3/4	KSUDB091A	1	60	208 - 230	187~253	13.4	15	9.0	1	9	1	0.4
1	KSUDB121A					13.4	15	9.0	1	9	1	0.4
1-1/2	KSUDB181A					16.0	25	11.5	1	11.5	1	1.6
<i>3x3 Cassette</i>												
2	KSSCB241A	1	60	208 - 230	187 - 253	16.0	25	11.5	1	11.5	1	1.6
2-1/2	KSSCB301A					19.1	30	14.0	1	14.0	1	1.6
3	KSSCB361A					32.0	35	22	1	22.0	2	1.6 x 2
3-1/2	KSSCB421A					32.0	40	22	1	22.0	2	1.6 x 2
4	KSSCB481A					32.0	40	22	1	22.0	2	1.6 x 2

Voltage tolerance is ±10%.

Maximum allowable voltage unbalance is 2%.

MCA = Minimum Circuit Ampacity.

Maximum Overcurrent Protection (MOP) is calculated as follows: (Largest motor FLA x 2.25) + (Sum of other motor FLA) rounded down to the nearest standard fuse size.

LRA = Locked Rotor Amps

RLA = Rated Load Amps.

FLA = Full Load Amps

FUNCTIONS, CONTROLS, OPTIONS

Table 9: Single Zone Four-Way Cassette Indoor Unit Functions, Controls, Options Table.

Indoor Unit Type		KNUDB091A, KNUDB121A 2x2 Cassette (9K, 12K)	KNUDB181A 2x2 Cassette (18K)	KNSCB241A, KNSCB301A 3x3 Cassette (24K, 30K)	KNSCB361A, KNSCB421A, KNSCB481A 3x3 Cassette (36K, 42K, 48K)
Airflow	Air Supply Outlet	4	4	4	4
	Airflow Direction Control (Up/Down)	√	√	√	√
	Auto Swing (Up/Down)	√	√	√	√
	Airflow Steps (Fan/Cool/Heat)	4 / 5 / 4	4 / 5 / 4	4 / 5 / 5	4 / 5 / 5
	Jet Cool/Heat	√ / X	√ / X	√ / √	√ / √
	Swirl Wind	√	√	√	√
	Refresh Mode/Smart Mode	X	X	√	√
	Indirect Wind / Direct Wind	√	√	√	√
	Filter	Long-life Prefilter (Washable) ¹	√	√	√
Instal.	Drain Pump	√	√	√	√
	High Ceiling Operation ²	√	√	√	√
Reli-ability	Hot Start	√	√	√	√
	Self Diagnosis	√	√	√	√
	Soft Dry Operation	√	√	√	√
Convenience	Auto Cleaning	√	√	√	√
	Auto Operation (Artificial Intelligence)	√	√	√	√
	Auto Changeover	√	√	√	√
	Auto Restart	√	√	√	√
	Child Lock ²	√	√	√	√
	Forced Cooling Operation	√	√	√	√
	Group Control ²	√	√	√	√
	Sleep Mode	√	√	√	√
	Timer (On/Off)	√	√	√	√
	Timer (Weekly) ²	√	√	√	√
	Two Thermistor Control ²	√	√	√	√
Automatic Filter Sign Check ²	√	√	√	√	
Individual Control	Program Controllers (MultiSITE CRC)	○ (PREMTBVC2/C3/C4)			
	Simple Remote Controller	○ (PREMTC00U)	○ (PREMTC00U)	○ (PREMTC00U)	○ (PREMTC00U)
	Standard III Remote Controllers	○ (PREMTB101/BB11)	○ (PREMTB101/BB11)	○ (PREMTB101/BB11)	○ (PREMTB101/BB11)
	Deluxe Remote Controller	○ (PREMTA201)	○ (PREMTA201)	○ (PREMTA201)	○ (PREMTA201)
Network	Wireless Handheld Remote Controller	○ (PQWRHQ0FDB)	○ (PQWRHQ0FDB)	○ (PWLSSB21H)	○ (PWLSSB21H)
	Dry Contact	○ (PDRYCB100/PDRYCB300/PDRYCB320/PDRYCB400)			
Other	Wi-Fi ³	○ (PWFMD200)	○ (PWFMD200)	○ (PWFMD200)	○ (PWFMD200)
	Group Control Wire	○ (PZCWRCG3)	○ (PZCWRCG3)	○ (PZCWRCG3)	○ (PZCWRCG3)

√: Standard Feature

○: Unit Option

X: Not Available

¹Primary washable filter. 14"x14"x1" for 2x2 units; 20.5"x20.5"x1" for 3x3 units.

²Requires wired zone controller.

³Requires Wi-Fi module PWFMD200.

⁴Not all controllers can support all features. Contact your LG representative for details.

FUNCTIONS, CONTROLS, OPTIONS

Table 10: Single Zone Four-Way Cassette Outdoor Unit Functions, Controls, Options Table.

Outdoor Unit		KUSXB091A, KUSXB121A 2x2 Cassette (18K)	KUSXB181A 2x2 Cassette (18K)	KUSXB241A, KUSXB301A 3x3 Cassette (24K, 30K)	KUSXB361A, KUSXB421A, KUSXB481A 3x3 Cassette (36K, 42K, 48K)
Reliability	Defrost/Deicing		√	√	√
	Base Pan Heater	○ (PQSH1202)	○ (PQSH1200)	○ (PQSH1200)	○ (PQSH1200)
	High Pressure Sensor	√	√	√	√
	Pressure Switch	√	√	√	√
	Restart Delay (Three [3] Minutes)	√	√	√	√
	Self Diagnosis	√	√	√	√
	Soft Start	√	√	√	√
Convenience	Night Quiet Operation	√	√	√	√
	Mode Lock	√ Cooling Only or Heating Only			
	Pump Down (Forced Cooling Oper.)	√	√	√	√
	Network Solution (LGAP)	√	√	√	√
Central Controllers	AC Smart 5	○ (PACS5A000)	○ (PACS5A000)	○ (PACS5A000)	○ (PACS5A000)
	ACP 5	○ (PACP5A000)	○ (PACP5A000)	○ (PACP5A000)	○ (PACP5A000)
	Network Solution (LGAP)	√	√	√	√
Integration Solutions	MultiSITE Communication Manager	○ (PBACNBTR0A)	○ (PBACNBTR0A)	○ (PBACNBTR0A)	○ (PBACNBTR0A)
	ACP 5 BACnet® Gateway	○ (PACP5A000)	○ (PACP5A000)	○ (PACP5A000)	○ (PACP5A000)
	LonWorks® Gateway	○ (ZHWLONWK0)	○ (ZHWLONWK0)	○ (ZHWLONWK0)	○ (ZHWLONWK0)
Special Functions	AHU Communications Kit	X	○ (PAHCMR000)	○ (PAHCMR000)	○ (PAHCMR000)

√: Standard Feature

○: Option. Optional accessories must be purchased separately.

X: Not Available

*Not all controllers can support all features. Contact your LG representative for details.

BACnet is a registered trademark of ASHRAE. LonWorks is a registered trademark of Echelon Corp.

ACCESSORIES

Accessories Table

Table 11: Accessories Overview. (Sold Separately)

Accessory	Model Number
24-13/32" x 24-13/32" (2' x 2') Four-Way Ceiling Cassette Panel — White (One Required) For Use with TR Frame for 2'x2' 9,000 Btu/h and 12,000 Btu/h Indoor Units; TQ Frame for 2'x2' 18,000 Btu/h Four-Way Ceiling Cassette Indoor Units	PT-QAGW0
Standard Panel — White (One Required) For Use with TP-B Frame for 3'x3' 24,000 Btu/h Indoor Units; TM-A Frame for 3'x3' 36,000 Btu/h, 42,000, 48,000 Btu/h Indoor Units	PT-AAGW0
Premium Panel (Includes Panel PT-AFGW0 + Air Purification Kit PTAHMP0) For Use with TP-B Frame for 3'x3' 24,000 Btu/h Indoor Units; TM-A Frame for 3'x3' 36,000 Btu/h, 42,000, 48,000 Btu/h Indoor Units	PT-AFGW0S
Air Purification Kit (Only Available with Premium Panel PTAHMP0) For Use with TP-B Frame for 3'x3' 24,000 Btu/h Indoor Units; TM-A Frame for 3'x3' 36,000 Btu/h, 42,000, 48,000 Btu/h Indoor Units	PTAHMP0
Cassette Decorative Cover For Use with TP-B Frame for 3'x3' 24,000 Btu/h Indoor Units; TM-A Frame for 3'x3' 36,000 Btu/h, 42,000, 48,000 Btu/h Indoor Units	PTDCA
Ventilation Flange For Use with All Four-Way Ceiling Cassette Indoor Units	PTVK430
AHU Communication Kit For Use with All Four-Way Ceiling Cassette Indoor Units	PAHCMR000
120W Drain Pan Heater For Use with 9k and 12k Outdoor Units	PQSH1202
120W Drain Pan Heater For Use with 18k ~ 48k Outdoor Units	PQSH1200
Auxiliary Heater Kit For Use with All Four-Way Ceiling Cassette Indoor Units	PRARH1
Wi-Fi Module For Use with All Four-Way Ceiling Cassette Indoor Units	PWFMD200
Low Ambient Wind Baffle For Use with 9 and 12k Capacities	ZLABGP01A
Low Ambient Wind Baffle For 18k and 24k Capacities (One [1] Required), 36k, 42k, and 48k Capacities (Two [2] Required)	ZLABGP04A
Single-Port Shutoff Valve For Use with All Four-Way Ceiling Cassette Indoor Units	PRHPZ010A

LG Monitoring View (LGMV) Diagnostic Software and Cable

LG Monitoring View (LGMV) is a maintenance and troubleshooting tool for Multi V™ air conditioning systems. LGMV formats are available for computer or mobile phone use.

The main screen for LGMV allows the user to view the following real time data:

- Actual inverter compressor speed
- Target inverter compressor speed
- Actual outdoor fan speed
- Target outdoor unit fan speed
- Actual superheat
- Target superheat
- Actual subcooler circuit superheat
- Target subcooler circuit superheat
- Main EEV position
- Subcooling EEV position
- Inverter compressor current transducer value
- Outdoor air temperature
- Actual high pressure/saturation temperature
- Actual low pressure/saturation temperature
- Suction temperature
- Inverter compressor discharge temperature
- Constant speed compressor discharge temperature
- Front outdoor coil pipe temperature
- Back outdoor coil pipe temperature
- Liquid line pipe temperature
- Subcooler inlet temperature
- Subcooler outlet temperature
- Average indoor unit (IDU) pipe temperature
- Inverter compressor operation indicator light
- Four-way reversing valve operation indicator light
- Pressure graph showing actual low pressure and actual high pressure levels
- Error code display
- Operating mode indicator
- Target high pressure
- Target low pressure
- PCB (printed circuit board) version
- Software version
- Installer name
- Model no. of outdoor units
- Site name
- Total number of connected indoor units
- Communication indicator lights
- Indoor unit capacity
- Indoor unit operating mode
- Indoor unit fan speed
- Indoor unit EEV position
- Indoor unit room temperature
- Indoor unit inlet pipe temperature
- Indoor unit outlet pipe temperature
- Indoor unit error code

Additional screens can be accessed by tabs on the main screen

1. Cycleview: Graphic of internal components including

- Compressors showing actual speeds
- EEVs
- Indoor Units
- Liquid injection valves
- Temperature and pressure sensors
- Four-way reversing valve
- Outdoor fans showing status and speeds

2. Graph:

Full screen graph of actual high and low pressures and high and low pressure limits. A sliding bar enables user to go back in time and view data.

3. Control IDU: Enables user to turn on all IDUs default setpoints of 86°F in heat mode or 64°F in cool mode.

4. Setting: Converts metric values to imperial values.

5. Making Data: Recording of real time data to a separate file created to be stored on the user's computer.

6. Loading Data: Recorded data from a saved ".CSV" file can be loaded to create an LGMV session.

7. Electrical Data: Screen is changed to show the following:

- Inverter compressor
- Amps / Volts / Power Hz
- Inverter control board fan Hz
- Constant compressor
- Current transducer value
- Phase

Figure 4: Sample Cycleview (Computer View Example).

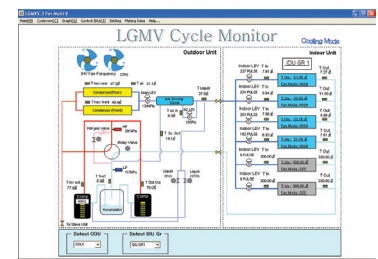

In lieu of connecting to the outdoor unit, user has the option to connect to the indoor unit with a connector kit. When connected through the indoor unit, user will not be able to record data.

This software can be used to both pre-set-up new systems and troubleshoot existing systems. LGMV data can be recorded to a ".CSV" file and emailed to an LG representative to assist with diagnostic evaluations.

LGMV is available in different formats. Contact your LG Sales Representative for system requirements and for more information.

ACCESSORIES

ThinQ

LG ThinQ is a built-in Wi-Fi module, along with a free smart phone app that provides monitoring and remote control capabilities for certain LG single zone systems. The app has the following features and benefits:

- Sign in to the app using LG credentials, or using Google® or Facebook® login credentials. Users only have to log in to the app once; the app remembers login details for subsequent logins.
- View current temperature settings of the air conditioning unit and change temperature, fan speed, and air flow direction from anywhere in the house or at a remote location (through the use of wireless connection). Multiple users can control the household air conditioning unit remotely.
- Monitor filter usage of the unit.
- Set up weekly schedules to start and stop air conditioner activity.
- Set up the unit to run in different Modes, depending on the user's schedule. Set up specific temperatures for when the user is home, away on vacation, or sleeping.
- Troubleshoot problems, and view tips on general maintenance of the system using the Smart Diagnosis function.

**Google is a registered trademark of Google Inc.; Facebook is a registered trademark of Facebook.*

Contact your LG Sales Representative or visit www.lghvac.com for system requirements, how to download the app, a user's manual, or other information.

Figure 5: Example of an LG Smart ThinQ Screen (appearances may differ depending on version of software).

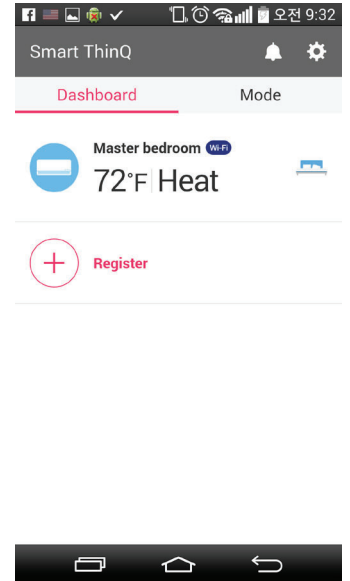

OUTDOOR UNIT DIMENSIONS

KUSXB091A, KUSXB121A

Figure 6: KUSXB091A, KUSXB121A Outdoor Unit Dimensions.

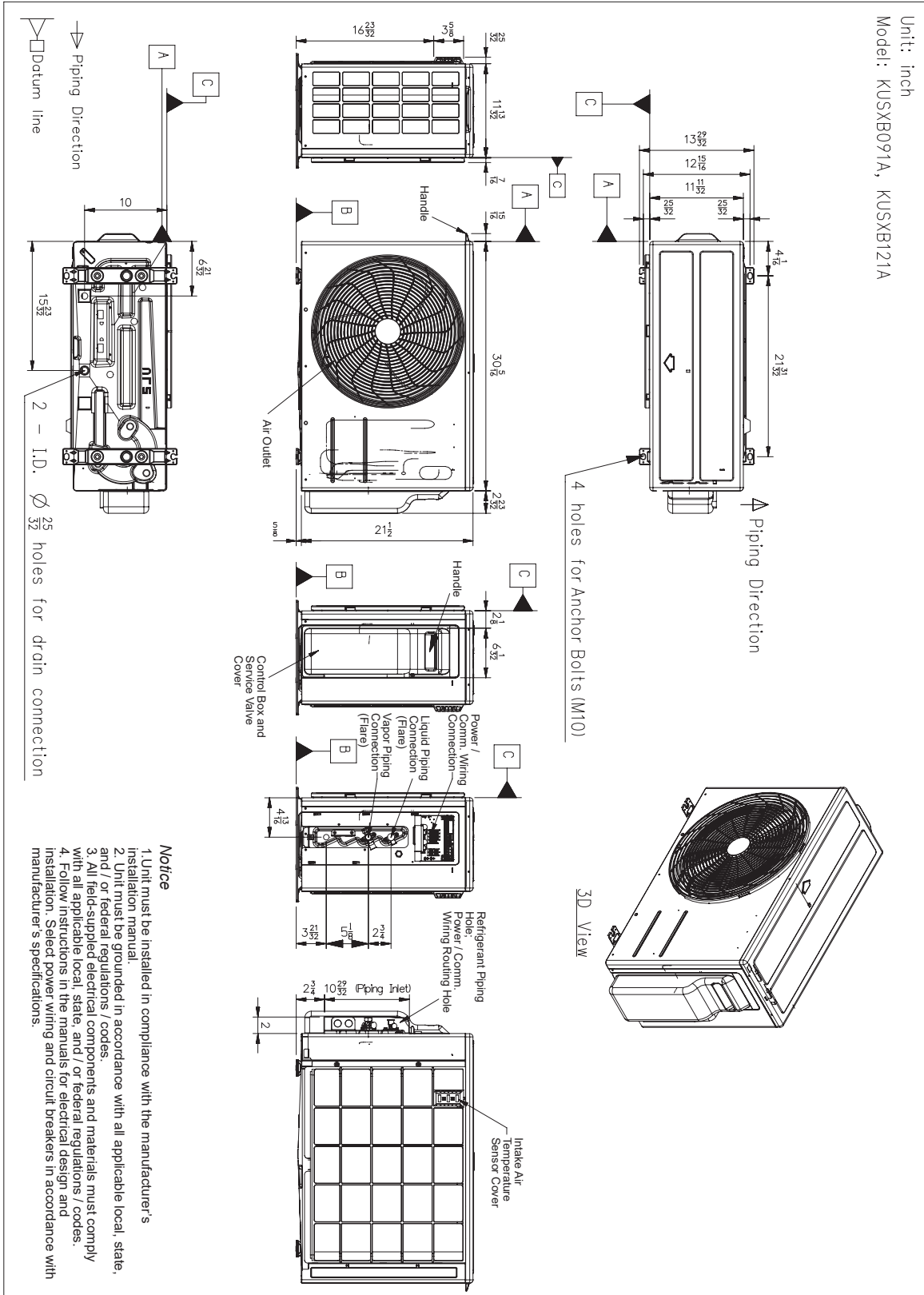

OUTDOOR UNIT DIMENSIONS

KUSXB181A, KUSXB241A, KUSXB301A

Figure 7: KUSXB181A, KUSXB241A, KUSXB301A Outdoor Unit Dimensions.

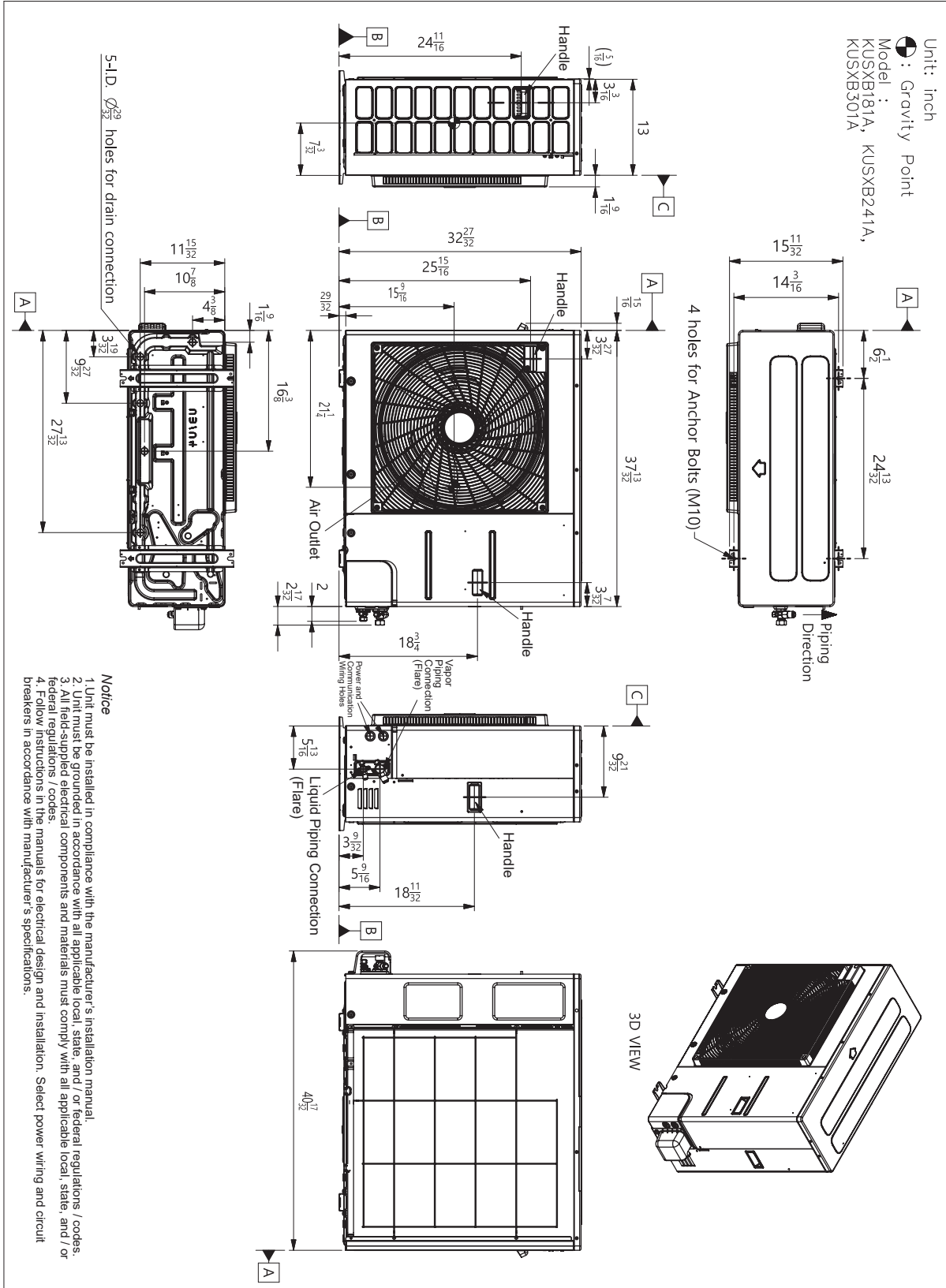

OUTDOOR UNIT CENTER OF GRAVITY / CORNER WEIGHTS

Figure 9: Outdoor Unit Center of Gravity and Corner Weight Diagram.

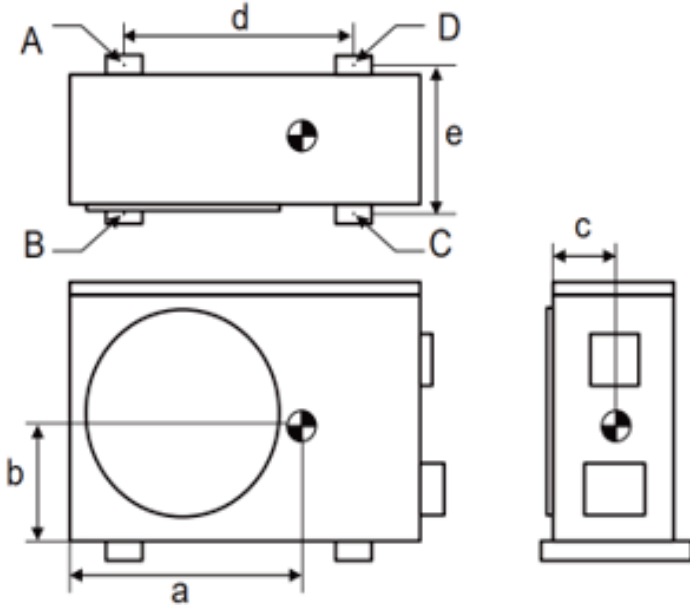

NOTICE

Diagram is for illustrative purposes only. Actual appearance depends on model type.

Table 12: Outdoor Unit Center of Gravity and Corner Weight Specifications.

Model No.	Weight (lb.)		Center of Gravity (in.)			Leg (in.)		Corner Weight (lb.)			
	Shipping	Net	a	b	c	d	e	A	B	C	D
KUSXB091A	79.4	75	19-11/16	8-19/32	5-1/4	22-3/16	12-31/32	8.7	12.2	28.5	25.6
KUSXB121A	79.4	75	19-11/16	8-19/32	5-1/4	22-3/16	12-31/32	8.7	12.2	28.5	25.6
KUSXB181A	154.3	136	23-5/16	12-13/32	6-13/16	24-13/32	14-3/16	19.2	26.9	52.4	37.4
KUSXB241A	154.3	136	23-5/16	12-13/32	6-13/16	24-13/32	14-3/16	19.2	26.9	52.4	37.4
KUSXB301A	159.4	141.1	23-7/32	12-19/32	5-29/32	24-13/32	14-3/16	11.6	13.2	62.0	54.3
KUSXB361A	214.3	190.2	27-7/32	21 15/32	6-5/8	24-13/32	14-3/16	15.8	18.1	84.9	74.4
KUSXB421A	214.3	190.2	27-7/32	21-15/32	6-5/8	24-13/32	14-3/16	15.8	18.1	84.9	74.4
KUSXB481A	214.3	190.2	27-7/32	21-15/32	6-5/8	24-13/32	14-3/16	15.8	18.1	84.9	74.4

NOTICE

- Design features and information of outdoor unit may be changed without notifications due to LG's policy of innovation.
- The center of gravity and corner weight may be different from the actual values because these are simulation results.

INDOOR UNIT DIMENSIONS

KNUDB091A, KNUDB121A

Figure 10: KNUDB091A, KNUDB121A 2x2 Indoor Unit Dimensions.

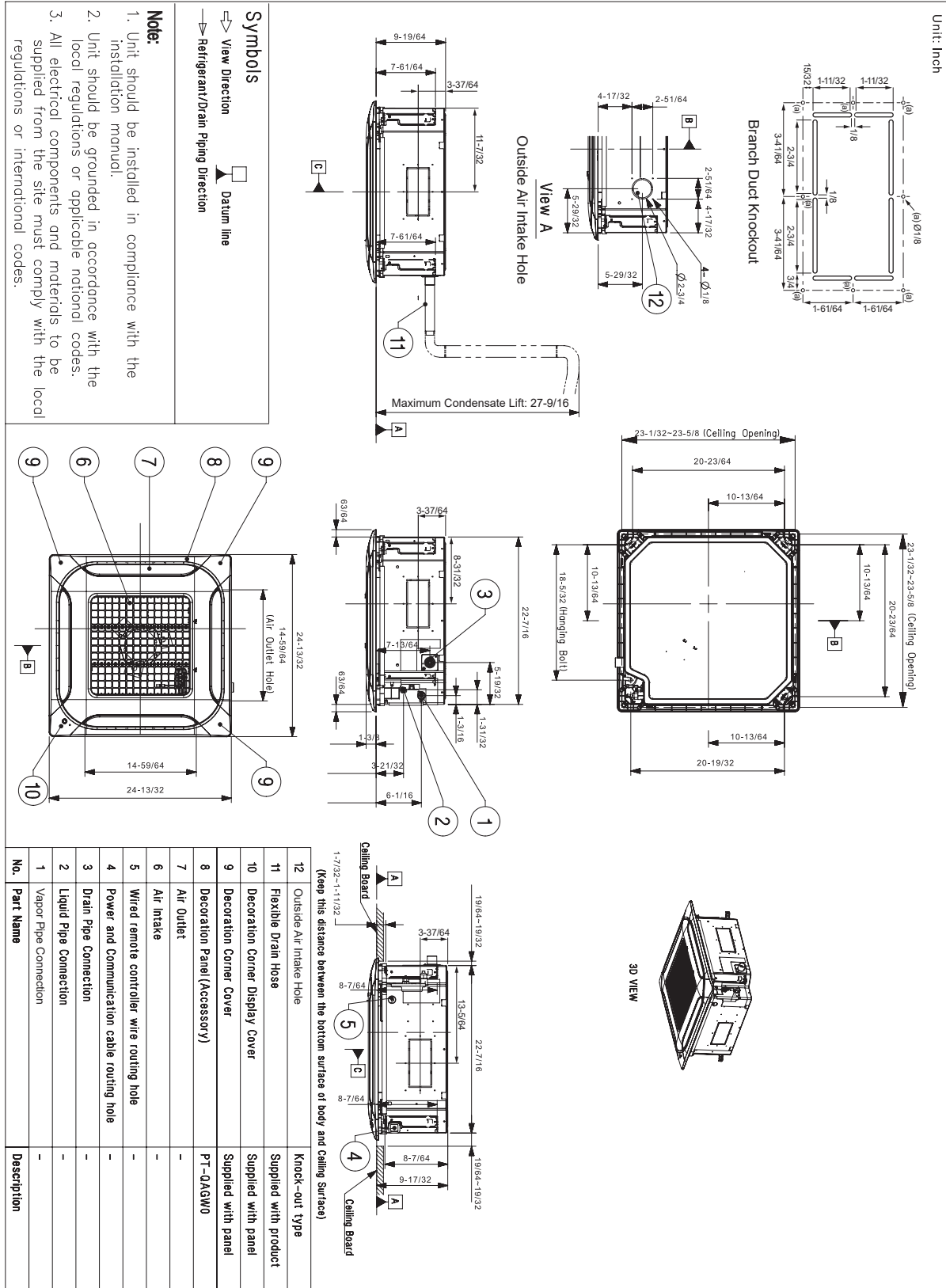

INDOOR UNIT DIMENSIONS

KNUDB181A

Figure 11: KNUDB181A 2x2 Indoor Unit Dimensions.

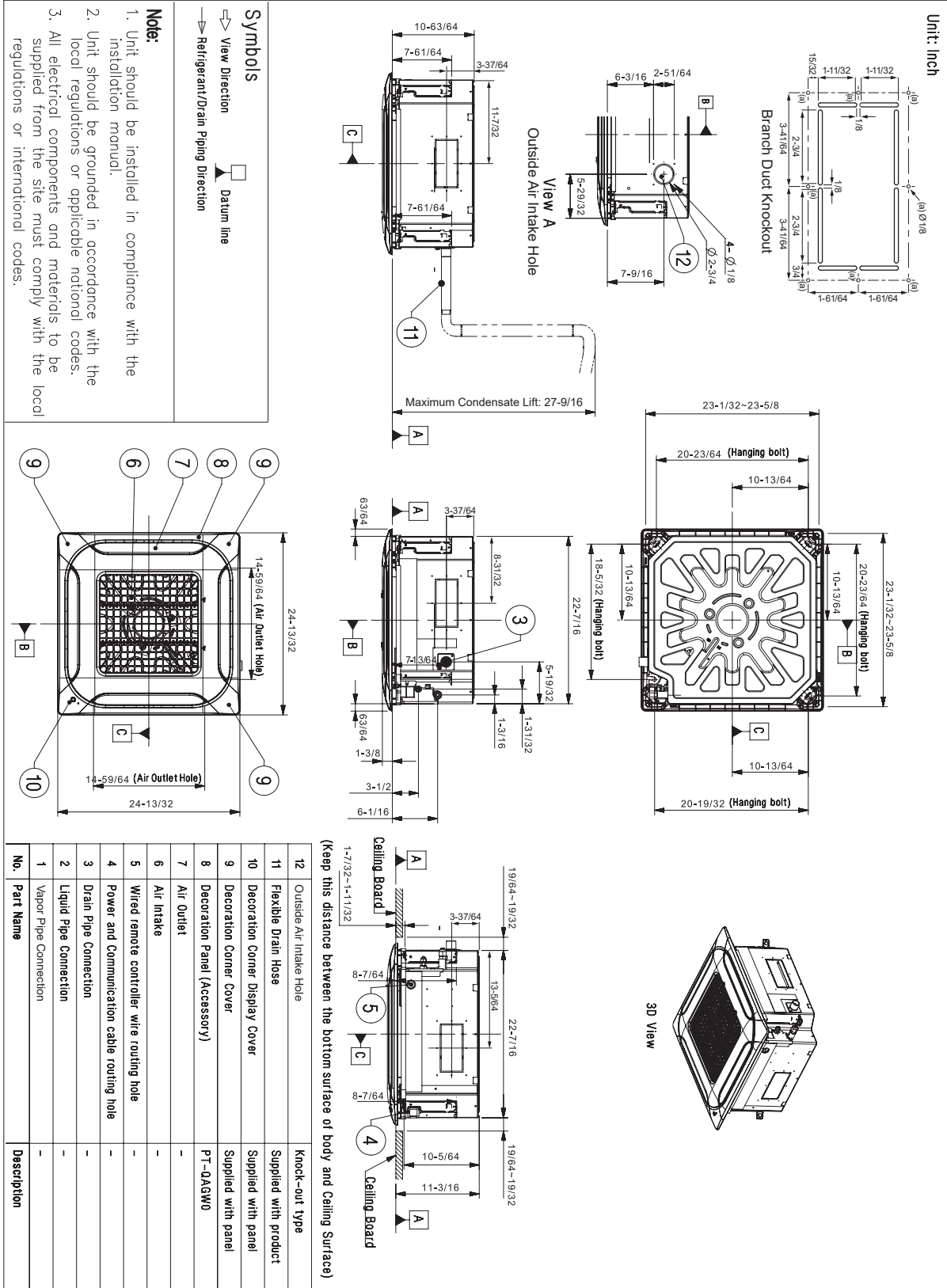

INDOOR UNIT DIMENSIONS

KNSCB241A

Figure 12: KNSCB241A 3x3 Indoor Unit Dimensions.

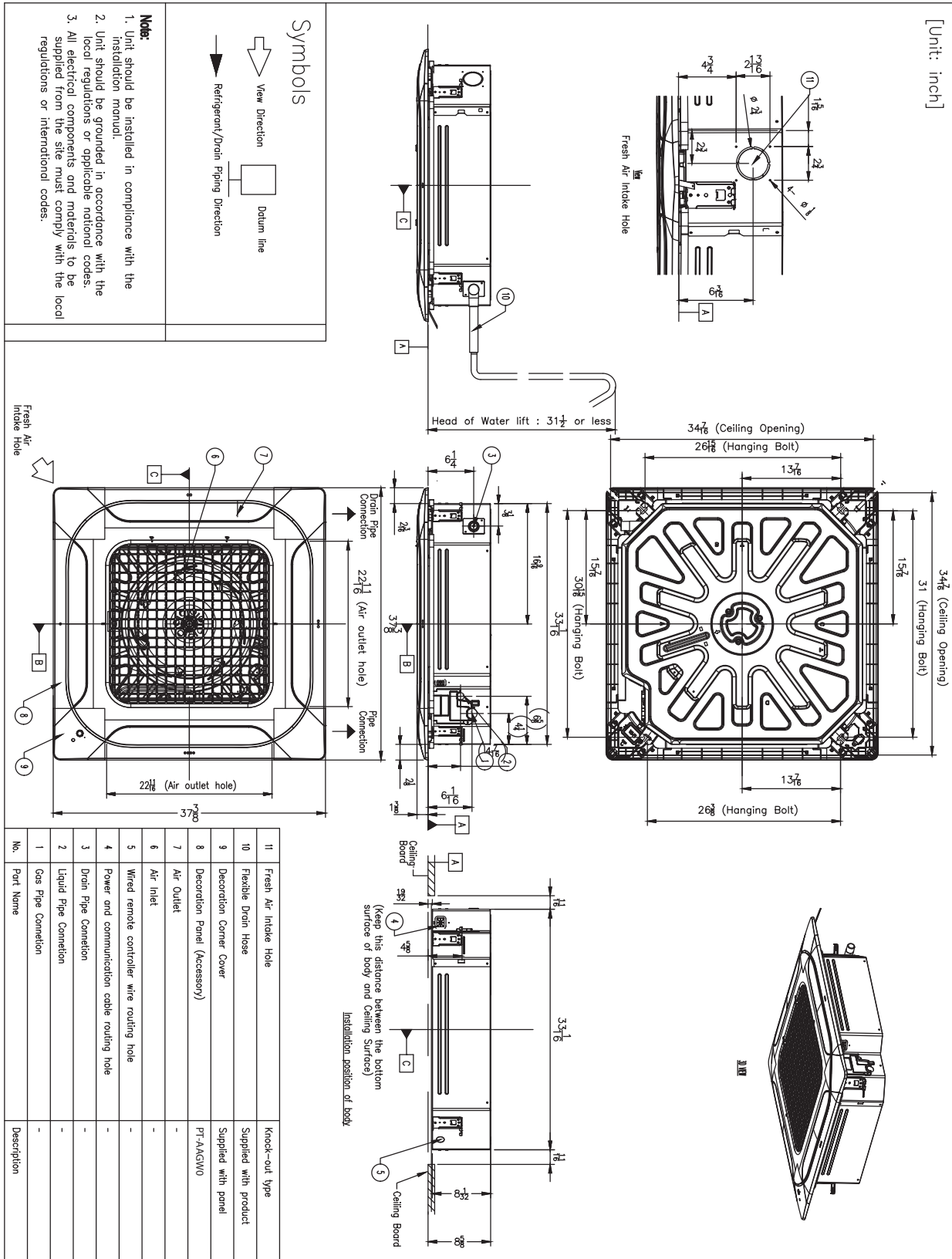

INDOOR UNIT DIMENSIONS

KNSCB301A, KNSCB361A, KNSCB421A, KNSCB481A

Figure 13: KNSCB301A, KNSCB361A, KNSCB421A, KNSCB481A 3x3 Indoor Unit Dimensions.

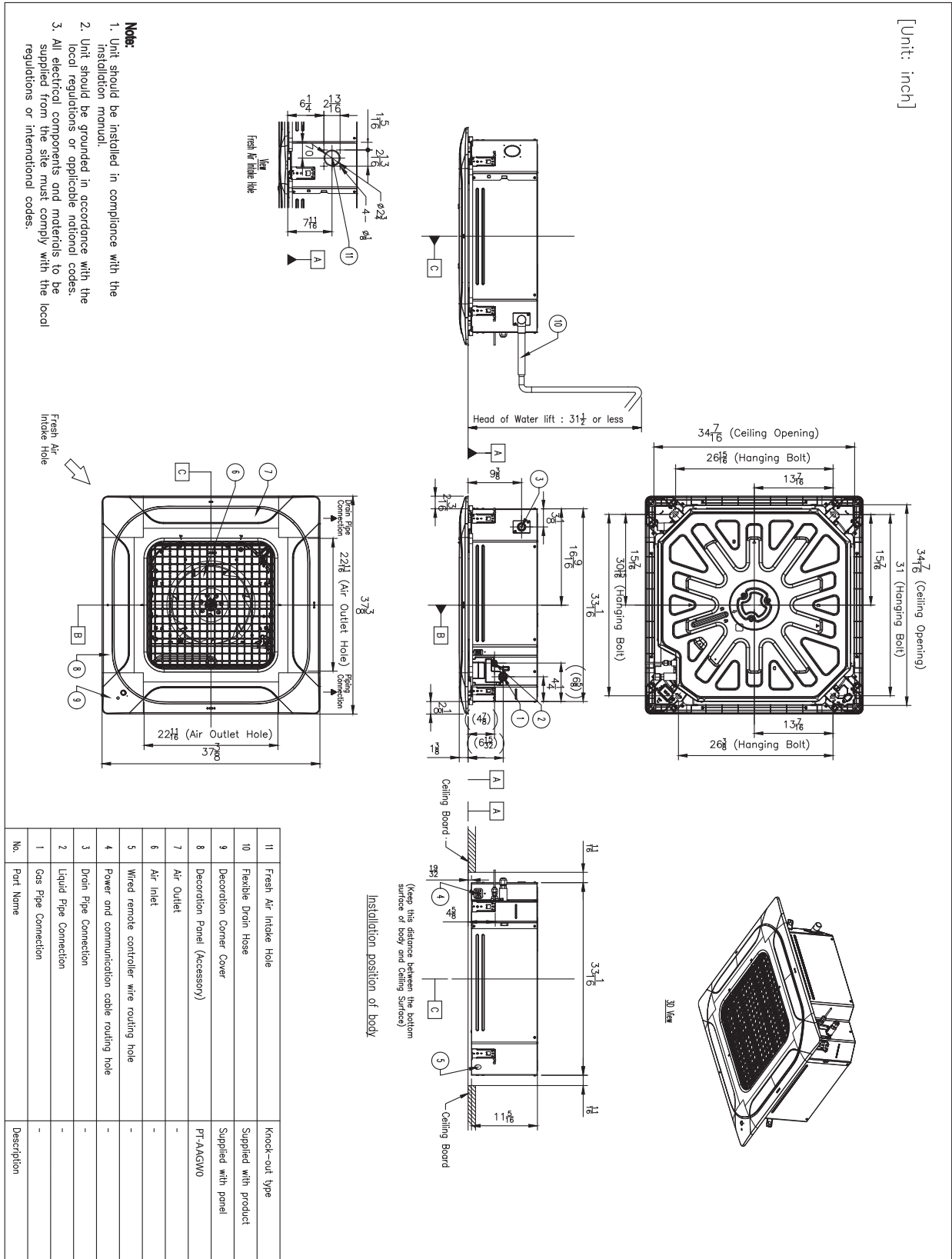

Figure 14: KNUDB091A Air Velocity and Temperature Distribution Charts.

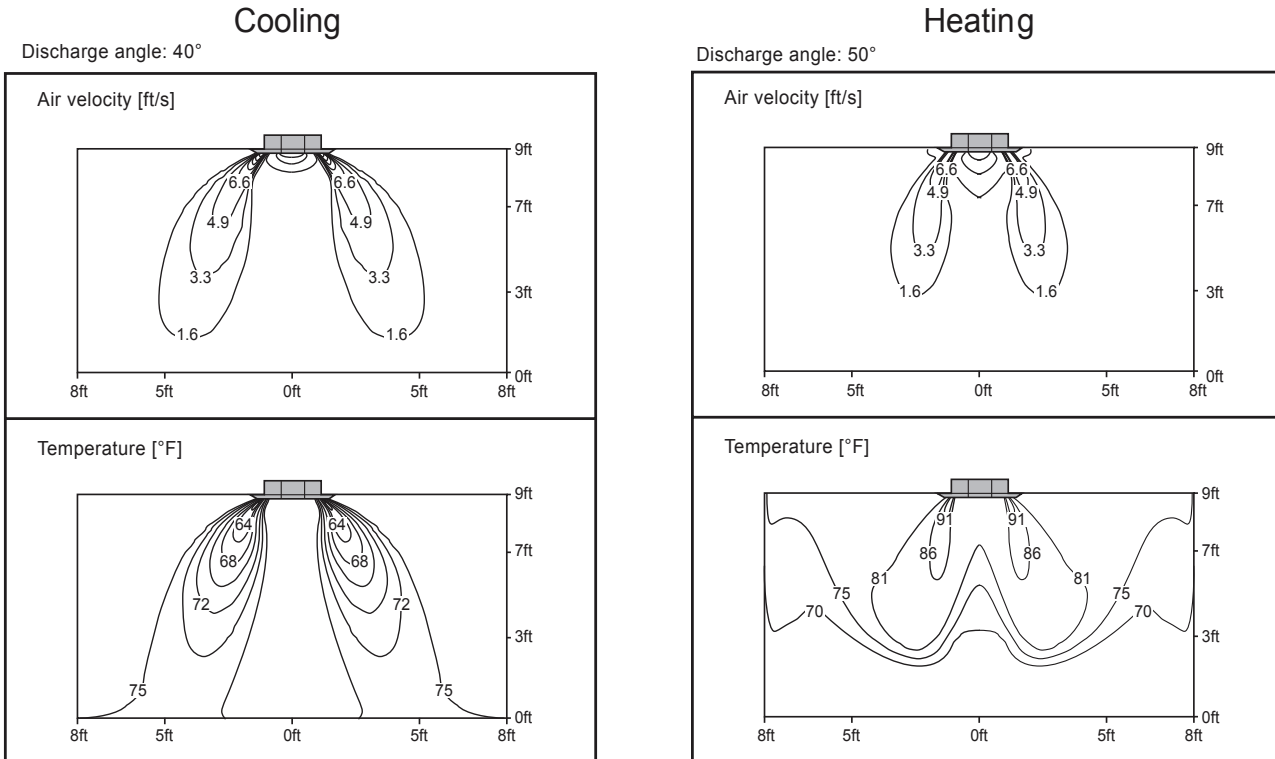
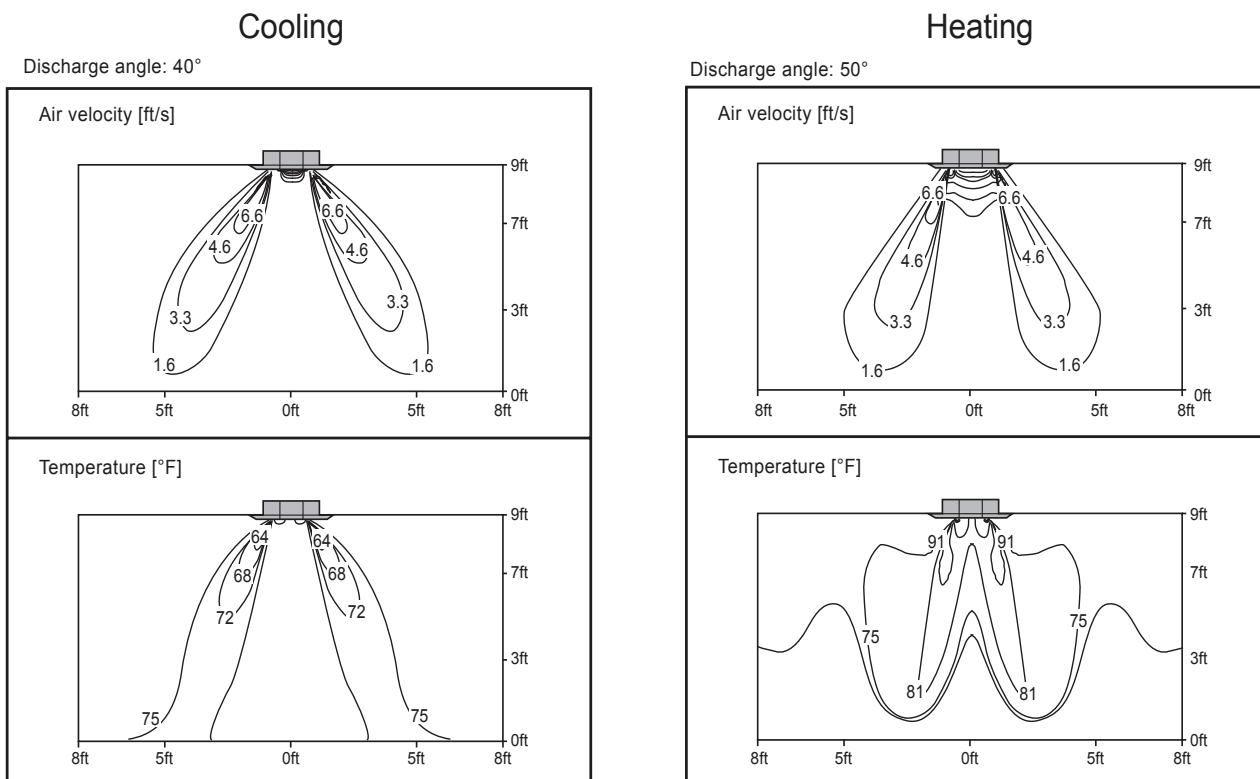

Figure 15: KNUDB121A Air Velocity and Temperature Distribution Charts.



AIR FLOW

Indoor Unit Air Flow / Temperature Distribution

Figure 16: KNUDB181A Air Velocity and Temperature Distribution Charts.

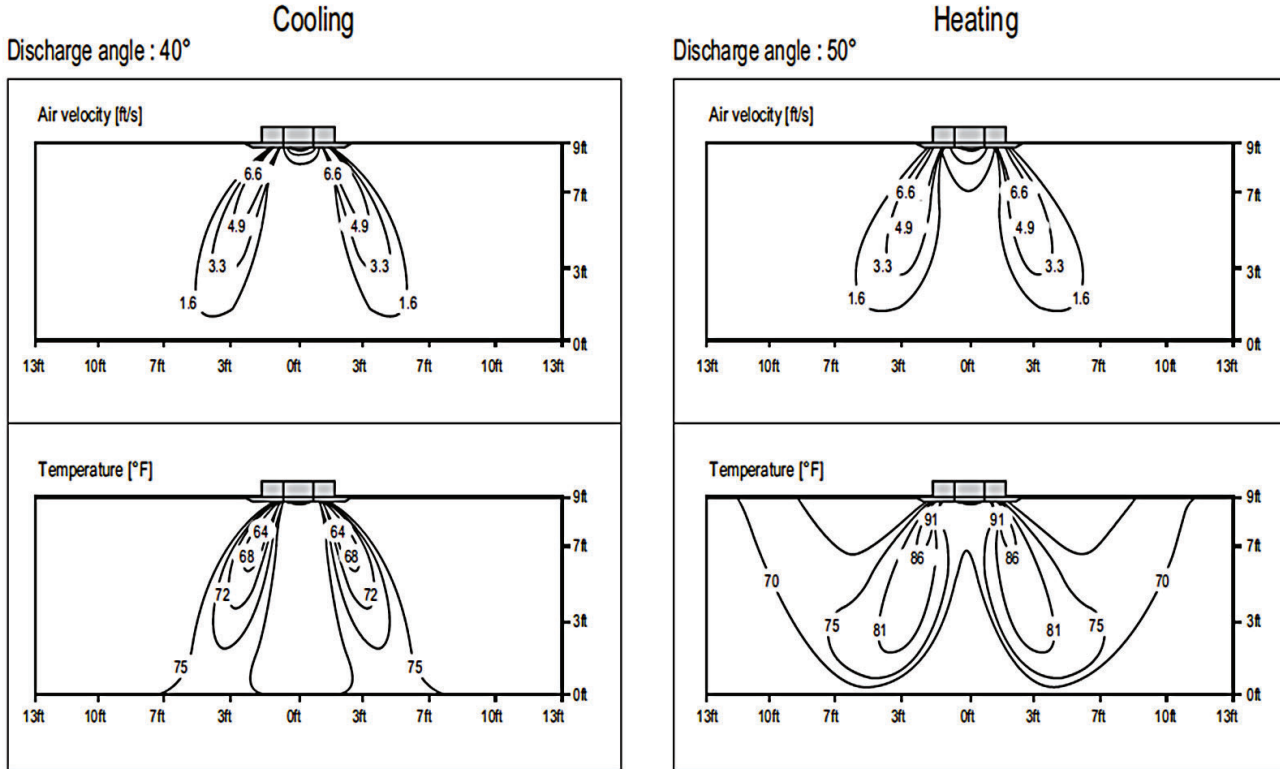

Figure 17: KNSCB241A Air Velocity and Temperature Distribution Charts.

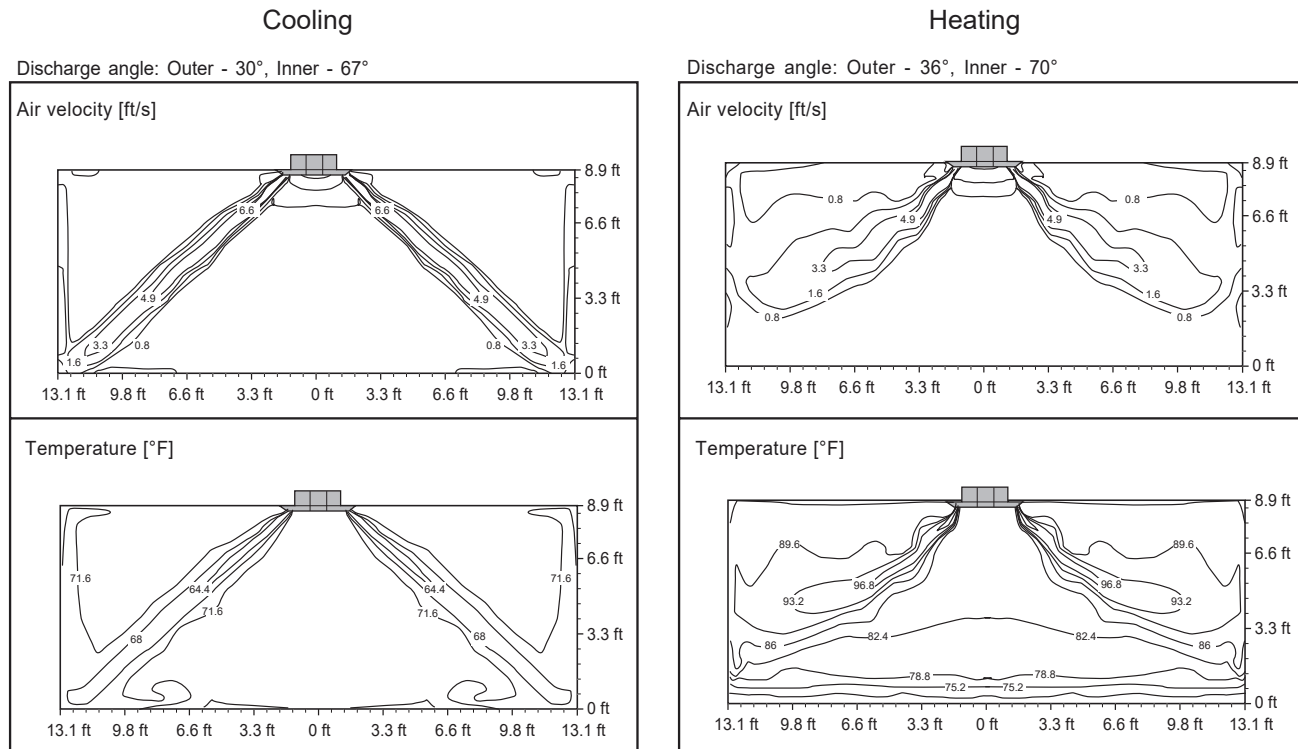

Figure 18: KNCSB301A, KNCSB361A Air Velocity and Temperature Distribution Charts.

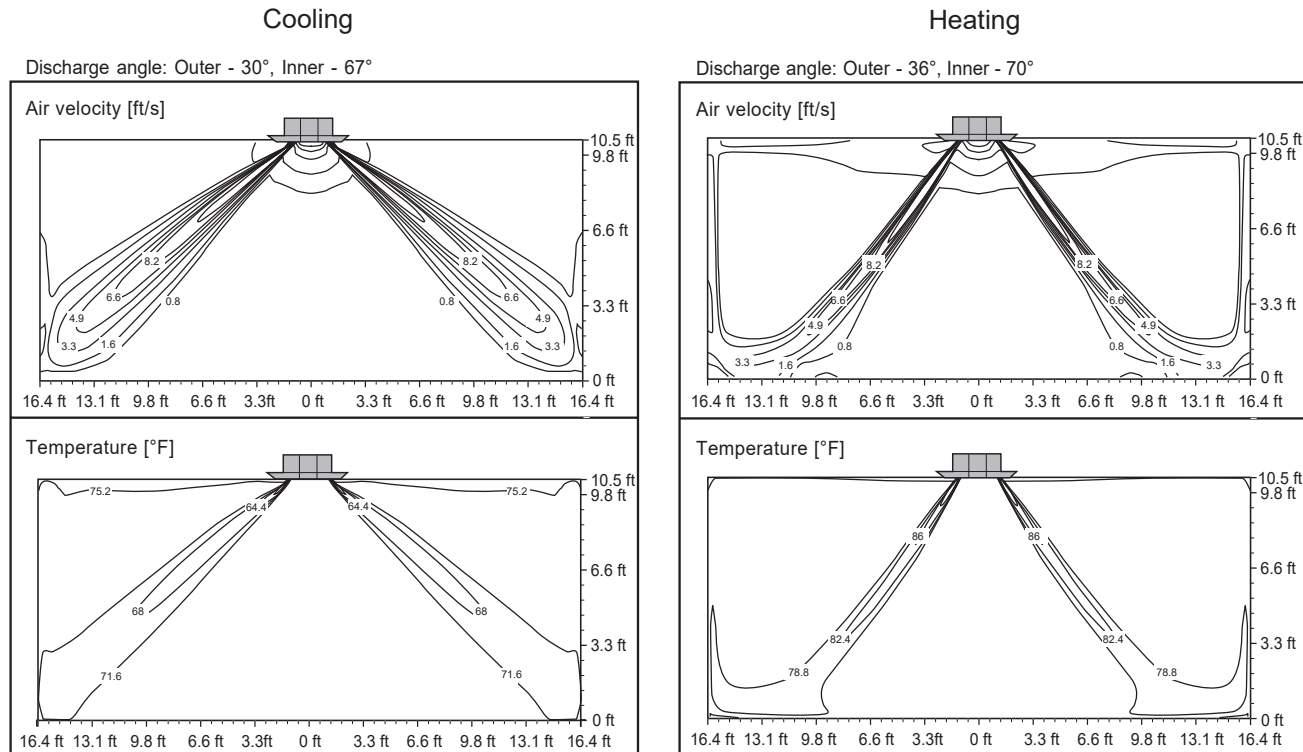
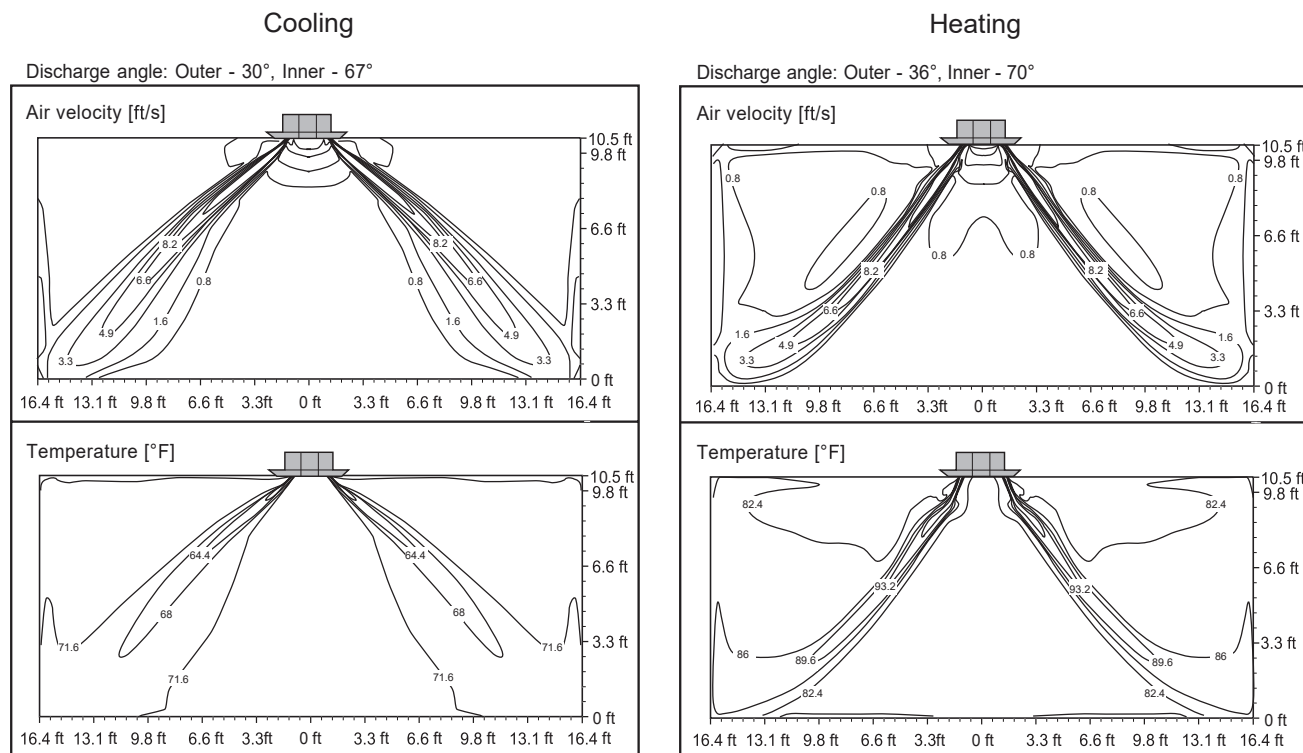

Figure 19: KNCSB421A, KNCSB481A Air Velocity and Temperature Distribution Charts.



ACOUSTIC DATA

Sound Pressure for Outdoor Units

Figure 20: Four-Way Ceiling Cassette Outdoor Unit Sound Pressure Level Measurement Location (For Illustrative Purposes Only; Appearance Depends on Model).

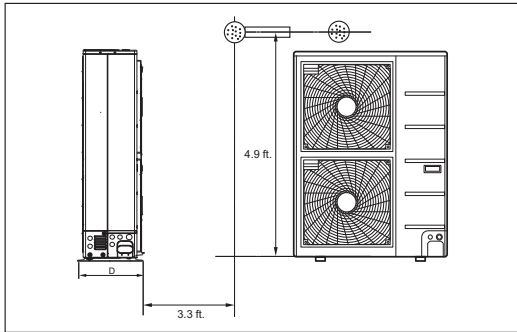

- Measurements taken with no attenuation and units operating at full load normal operating condition.
- Measurements are taken 3.3 feet away from the front of the unit.
- Sound level will vary depending on a range of factors such as construction (acoustic absorption coefficient) of particular area in which the equipment is installed.
- Sound levels are measured in dB(A)±1.
- Reference acoustic pressure 0dB=20µPa.
- Tested in anechoic chamber per ISO Standard 3745.

Table 13: Four-Way Ceiling Cassette Outdoor Unit Sound Pressure Levels (dB[A]).

Model	Sound Pressure Levels (dB[A])	
	Cooling	Heating
KUSXB091A	47	51
KUSXB121A	49	52
KUSXB181A	48	52
KUSXB241A	48	52
KUSXB301A	52	54
KUSXB361A	52	54
KUSXB421A	54	56
KUSXB481A	54	56

Figure 21: Four-Way Ceiling Cassette Outdoor Unit Sound Pressure Level Diagrams.

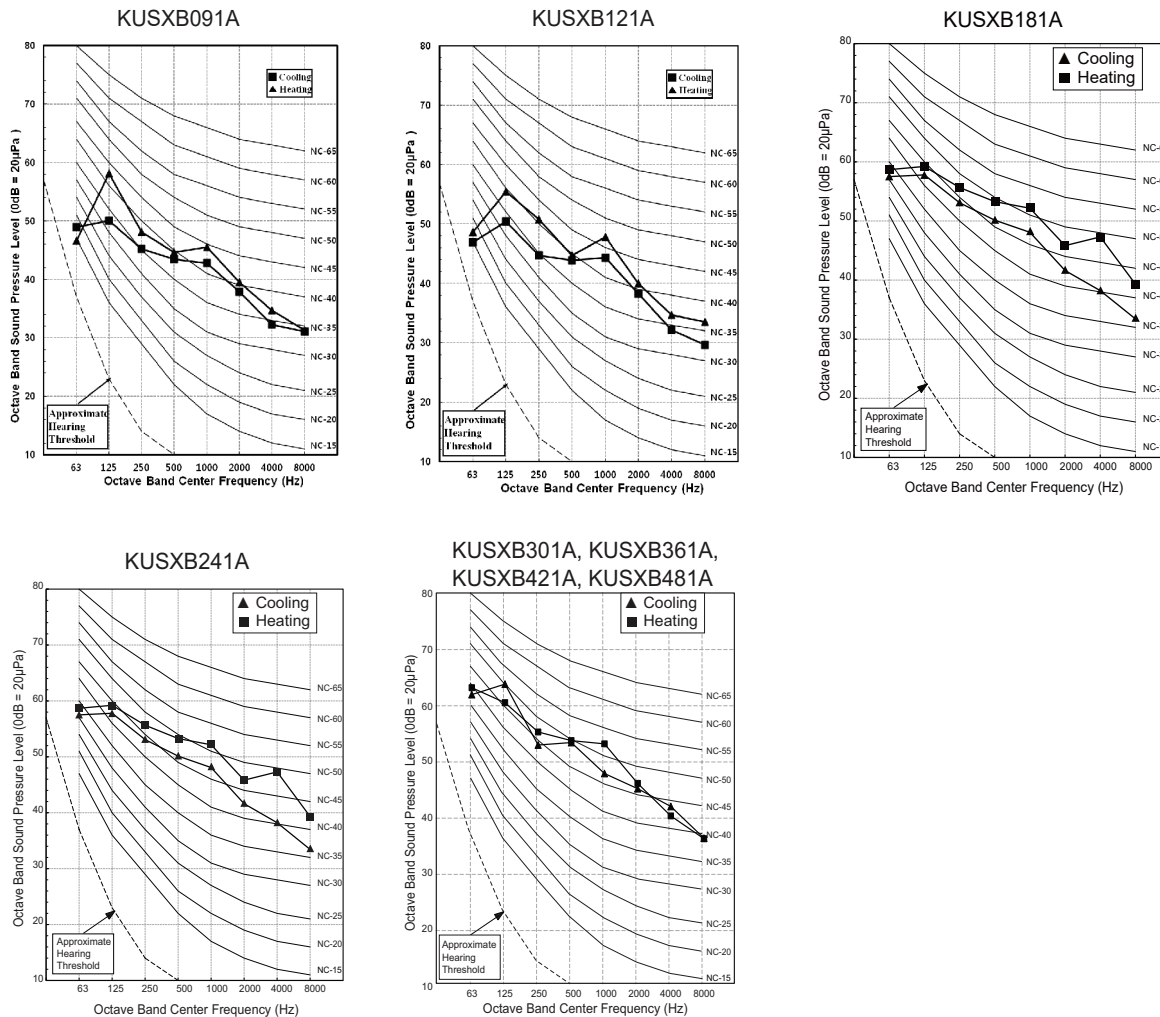

ACOUSTIC DATA

Sound Power for Outdoor Units

Table 14: Four-Way Ceiling Cassette Outdoor Unit Sound Power Levels (dB[A]).

Model	Sound Power Levels (dB[A])
KUSXB091A	-
KUSXB121A	-
KUSXB181A	65
KUSXB241A	65
KUSXB301A	67
KUSXB361A	65
KUSXB421A	71
KUSXB481A	71

- Data is valid under diffuse field conditions.
- Data is valid under nominal operating conditions.
- Sound power level is measured using rated conditions and tested in a reverberation chamber under ISO Standard 3741.
- Sound level will vary depending on a range of factors such as construction (acoustic absorption coefficient) of particular area in which the equipment is installed.
- Reference acoustic intensity: 0dB = 10E-6μW/m²

Figure 22: Four-Way Ceiling Cassette Outdoor Unit Sound Power Level Diagrams.

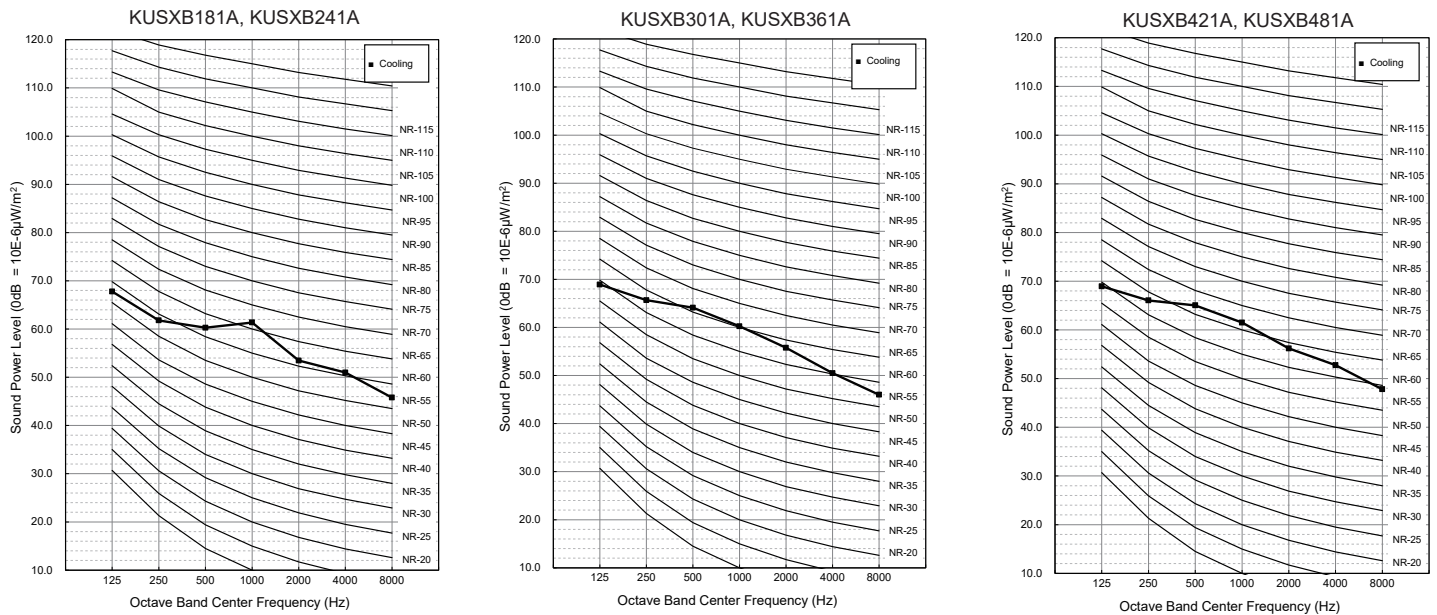

ACOUSTIC DATA

Sound Pressure for Indoor Units

Figure 23: Four-Way Ceiling Cassette Indoor Unit Sound Pressure Level Measurement Location.

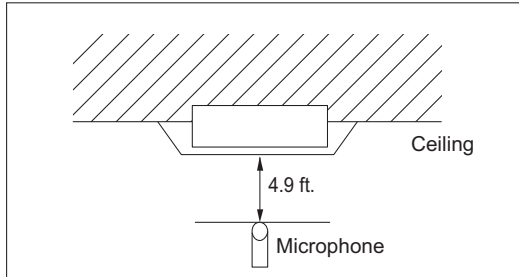

- Measurements taken with no attenuation and units operating at full load normal operating condition.
- Measurements are taken 4.9 ft. away from the front of the unit.
- Sound level will vary depending on a range of factors such as construction (acoustic absorption coefficient) of particular area in which the equipment is installed.
- Sound levels are measured in dB(A)±1.
- Reference acoustic pressure 0dB=20µPa.
- Tested in anechoic chamber per ISO Standard 3745.

Table 15: Four-Way Ceiling Cassette Indoor Unit Sound Pressure Levels (dB[A]).

Model	Sound Pressure Levels (dB[A])		
	H	M	L
KNUDB091A	36	33	30
KNUDB121A	38	35	32
KNUDB181A	41	39	36
KNSCB241A	40	37	35
KNSCB301A	42	41	40
KNSCB361A	44	42	41
KNSCB421A	46	43	41
KNSCB481A	46	43	41

Figure 24: Four-Way Ceiling Cassette Indoor Unit Sound Pressure Level Diagrams.

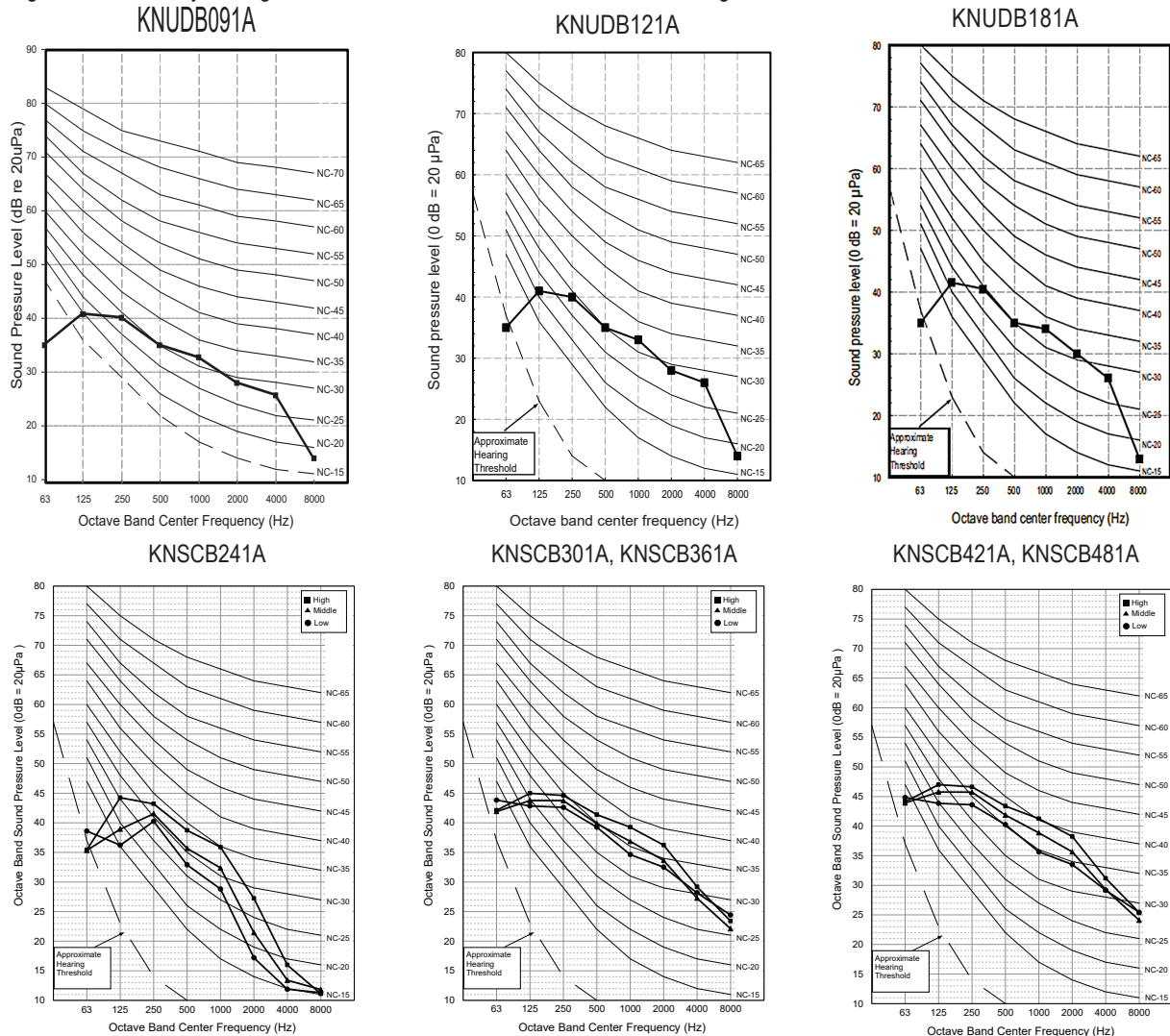

ACOUSTIC DATA

Sound Power for Indoor Units

Table 16: Four-Way Ceiling Cassette Indoor Unit Sound Power Levels (dB[A]).

Model	Sound Power Levels (dB[A])
	H
KNUDB091A	-
KNUDB121A	-
KNUDB181A	-
KNSCB241A	57
KNSCB301A	61
KNSCB361A	61
KNSCB421A	62
KNSCB481A	62

- Data is valid under diffuse field conditions.
- Data is valid under nominal operating conditions.
- Sound power level is measured using rated conditions and tested in a reverberation chamber under ISO Standard 3741.
- Sound level will vary depending on a range of factors such as construction (acoustic absorption coefficient) of particular area in which the equipment is installed.
- Reference acoustic intensity: 0dB = 10E-6μW/m²

Figure 25: Four-Way Ceiling Cassette Indoor Unit Sound Power Level Diagrams.

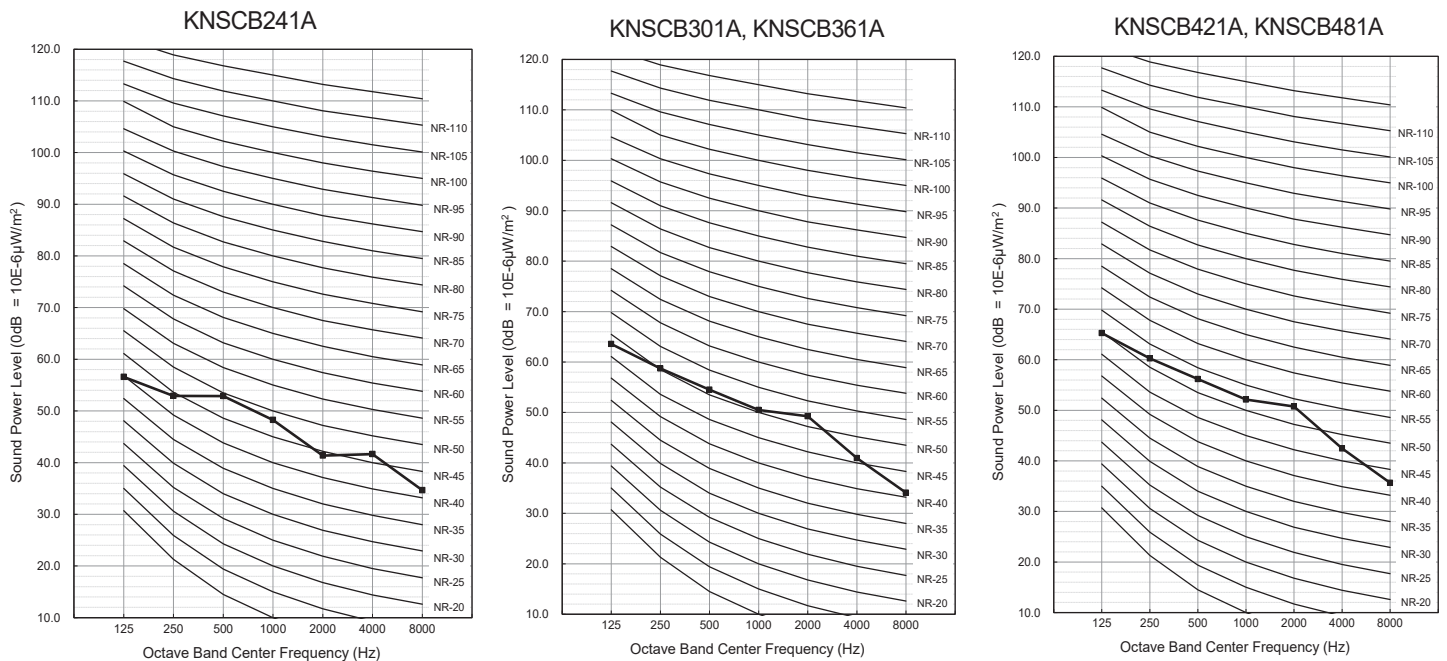

Product Data

PERFORMANCE DATA

Cooling Capacity on page 41

Maximum Cooling Capacity on page 49

Heating Capacity on page 57

Maximum Heating Capacity on page 65

Correction Factors on page 73

Check Selection on page 74

COOLING CAPACITY

KSUDB091A (KNUDB091A / KUSXB091A)

Table 17: KSUDB091A (KNUDB091A / KUSXB091A) Cooling Capacities.

Outdoor Air Temp. (°F DB)	Indoor Air Temperature (°F DB / °F WB)																	
	68 / 57			72 / 61			77 / 64			80 / 67			86 / 72			90 / 75		
	TC	SHC	PI	TC	SHC	PI	TC	SHC	PI	TC	SHC	PI	TC	SHC	PI	TC	SHC	PI
-4	8.85	6.88	0.38	9.40	7.27	0.40	9.95	7.04	0.41	10.35	7.18	0.42	11.05	7.24	0.42	11.60	7.38	0.43
-0.4	8.85	6.92	0.39	9.40	7.31	0.40	9.94	7.08	0.42	10.34	7.23	0.42	11.04	7.29	0.43	11.59	7.43	0.44
5	8.84	6.98	0.40	9.39	7.38	0.41	9.94	7.14	0.42	10.33	7.29	0.43	11.03	7.35	0.44	11.58	7.49	0.45
10	8.83	7.04	0.40	9.38	7.43	0.41	9.93	7.19	0.43	10.32	7.35	0.44	11.03	7.41	0.44	11.57	7.55	0.45
15	8.83	7.09	0.41	9.37	7.49	0.42	9.92	7.26	0.44	10.32	7.40	0.44	11.02	7.47	0.45	11.56	7.61	0.46
20	8.82	7.15	0.41	9.37	7.55	0.43	9.91	7.31	0.44	10.31	7.46	0.45	11.01	7.52	0.46	11.56	7.67	0.47
25	8.81	7.20	0.42	9.36	7.61	0.43	9.91	7.37	0.45	10.30	7.52	0.46	11.00	7.58	0.46	11.55	7.73	0.47
30	8.80	7.26	0.42	9.35	7.67	0.44	9.90	7.43	0.46	10.29	7.58	0.46	10.99	7.65	0.47	11.54	7.79	0.48
35	8.80	7.31	0.43	9.34	7.72	0.45	9.89	7.48	0.46	10.29	7.64	0.47	10.98	7.70	0.47	11.53	7.85	0.48
40	8.79	7.37	0.44	9.34	7.78	0.45	9.88	7.54	0.47	10.28	7.69	0.47	10.97	7.76	0.48	11.52	7.91	0.49
45	8.78	7.43	0.44	9.33	7.84	0.46	9.88	7.59	0.47	10.27	7.75	0.48	10.97	7.82	0.49	11.51	7.96	0.50
50	8.78	7.47	0.45	9.32	7.90	0.47	9.87	7.65	0.48	10.26	7.81	0.49	10.96	7.88	0.50	11.50	8.02	0.51
55	8.77	7.53	0.45	9.32	7.96	0.47	9.86	7.71	0.49	10.25	7.87	0.49	10.95	7.93	0.50	11.49	8.09	0.51
60	8.76	7.58	0.46	9.31	8.01	0.47	9.85	7.76	0.49	10.25	7.93	0.50	10.94	7.99	0.51	11.49	8.14	0.52
65	8.76	7.64	0.47	9.30	8.07	0.48	9.85	7.82	0.50	10.24	7.98	0.51	10.93	8.05	0.52	11.48	8.20	0.53
70	8.75	7.69	0.47	9.29	8.13	0.49	9.84	7.87	0.51	10.23	8.04	0.51	10.92	8.11	0.52	11.47	8.26	0.53
75	8.54	7.57	0.50	9.08	8.01	0.52	9.62	7.76	0.53	10.02	7.93	0.54	10.71	8.01	0.55	11.25	8.17	0.56
80	8.33	7.44	0.52	8.87	7.88	0.54	9.41	7.65	0.56	9.80	7.82	0.57	10.49	7.90	0.58	11.03	8.07	0.59
85	8.12	7.30	0.55	8.66	7.75	0.57	9.20	7.53	0.59	9.59	7.71	0.59	10.28	7.80	0.60	10.82	7.97	0.62
90	7.91	7.17	0.57	8.45	7.61	0.59	8.99	7.41	0.61	9.38	7.58	0.62	10.06	7.69	0.64	10.60	7.87	0.65
95	7.69	7.09	0.60	8.22	7.55	0.62	8.76	7.35	0.64	9.00	7.42	0.65	9.83	7.65	0.66	10.36	7.83	0.68
100	7.50	6.90	0.62	8.03	7.35	0.65	8.57	7.17	0.67	8.89	7.30	0.68	9.64	7.49	0.69	10.18	7.67	0.71
105	7.31	6.71	0.65	7.85	7.16	0.67	8.38	7.00	0.70	8.77	7.19	0.71	9.45	7.32	0.72	9.99	7.51	0.73
110	7.12	6.48	0.67	7.66	6.93	0.70	8.20	6.78	0.72	8.58	6.97	0.73	9.27	7.11	0.75	9.80	7.30	0.76
115	6.94	6.29	0.70	7.47	6.74	0.72	8.01	6.61	0.75	8.40	6.80	0.76	9.08	6.94	0.77	9.61	7.13	0.79
118	6.83	6.24	0.71	7.36	6.69	0.74	7.90	6.57	0.77	8.28	6.77	0.78	8.97	6.92	0.79	9.50	7.12	0.81
122	6.79	6.23	0.74	7.32	6.68	0.76	7.86	6.56	0.79	8.25	6.75	0.80	8.93	6.91	0.82	9.46	7.11	0.83

Performance Data

DB: Dry Bulb Temperature (°F) WB: Wet Bulb Temperature (°F) TC: Total Capacity (kBtu/h)
 SHC: Sensible Capacity (kBtu/h) PI: Power Input (kW) (includes compressor, indoor fan motor and outdoor fan motor)

- All capacities are net, evaporator fan motor heat is deducted.
- Cooling range can be extended from 5°F down to -4°F using the Low Ambient Wind Baffle Kit (sold separately).
- Grey shading indicates reference data. Operation outside of the verified temperature range is subject to decreased performance and / or safety interruption.

- Direct interpolation is permissible. ⚠ Do not extrapolate.
 Capacity as rated: 0 ft. above sea level with 24.6 ft. of refrigerant piping. 0 ft. level difference between outdoor and indoor units.
 Cooling capacity rating obtained with air entering the indoor unit at 80°F dry bulb (DB) and 67°F wet bulb (WB), and outdoor ambient conditions of 95°F dry bulb (DB) and 75°F wet bulb (WB).

COOLING CAPACITY

KSUDB121A (KNUDB121A / KUSXB121A)

Table 18: KSUDB121A (KNUDB121A / KUSXB121A) Cooling Capacities.

Outdoor Air Temp. (°F DB)	Indoor Air Temperature (°F DB / °F WB)																	
	68 / 57			72 / 61			77 / 64			80 / 67			86 / 72			90 / 75		
	TC	SHC	PI	TC	SHC	PI	TC	SHC	PI	TC	SHC	PI	TC	SHC	PI	TC	SHC	PI
-4	10.92	7.83	0.50	11.59	8.26	0.52	12.27	8.00	0.54	12.76	8.17	0.55	13.62	8.24	0.55	14.30	8.40	0.57
-0.4	10.91	7.87	0.51	11.59	8.31	0.52	12.26	8.05	0.55	12.75	8.22	0.55	13.62	8.29	0.56	14.29	8.45	0.57
5	10.90	7.94	0.52	11.57	8.39	0.54	12.25	8.12	0.55	12.74	8.29	0.56	13.60	8.36	0.57	14.28	8.52	0.58
10	10.89	8.00	0.52	11.57	8.45	0.54	12.24	8.18	0.56	12.73	8.36	0.57	13.60	8.43	0.58	14.27	8.59	0.59
15	10.88	8.06	0.53	11.56	8.52	0.55	12.23	8.25	0.57	12.72	8.42	0.58	13.59	8.50	0.59	14.26	8.66	0.60
20	10.87	8.13	0.54	11.55	8.59	0.56	12.22	8.31	0.58	12.71	8.49	0.58	13.57	8.56	0.60	14.25	8.72	0.61
25	10.87	8.19	0.55	11.54	8.65	0.57	12.22	8.38	0.59	12.70	8.56	0.60	13.57	8.63	0.60	14.24	8.79	0.62
30	10.85	8.25	0.55	11.53	8.72	0.57	12.20	8.45	0.60	12.69	8.62	0.60	13.55	8.70	0.61	14.23	8.86	0.63
35	10.85	8.31	0.56	11.52	8.78	0.58	12.20	8.51	0.60	12.68	8.69	0.61	13.54	8.76	0.62	14.21	8.93	0.63
40	10.84	8.38	0.57	11.51	8.85	0.59	12.19	8.57	0.61	12.67	8.75	0.62	13.53	8.83	0.63	14.21	9.00	0.65
45	10.83	8.45	0.58	11.51	8.92	0.60	12.18	8.63	0.62	12.66	8.82	0.63	13.52	8.89	0.64	14.20	9.06	0.65
50	10.82	8.50	0.58	11.49	8.98	0.61	12.17	8.70	0.63	12.65	8.88	0.64	13.51	8.96	0.65	14.18	9.13	0.66
55	10.82	8.57	0.59	11.49	9.05	0.61	12.16	8.77	0.64	12.64	8.95	0.65	13.50	9.02	0.66	14.17	9.20	0.67
60	10.80	8.63	0.60	11.48	9.12	0.62	12.15	8.83	0.65	12.64	9.02	0.65	13.49	9.09	0.66	14.16	9.26	0.68
65	10.80	8.69	0.61	11.47	9.18	0.63	12.14	8.89	0.65	12.62	9.08	0.66	13.48	9.15	0.68	14.15	9.33	0.69
70	10.79	8.75	0.61	11.46	9.25	0.64	12.13	8.95	0.66	12.62	9.14	0.67	13.47	9.22	0.68	14.14	9.40	0.69
75	10.53	8.61	0.65	11.20	9.11	0.68	11.86	8.83	0.70	12.35	9.02	0.71	13.20	9.11	0.72	13.88	9.29	0.74
80	10.27	8.47	0.68	10.94	8.97	0.71	11.61	8.70	0.74	12.09	8.90	0.74	12.94	8.99	0.75	13.60	9.18	0.77
85	10.01	8.31	0.72	10.68	8.82	0.74	11.35	8.57	0.77	11.82	8.77	0.78	12.67	8.87	0.79	13.34	9.07	0.81
90	9.76	8.15	0.75	10.42	8.66	0.78	11.08	8.43	0.80	11.56	8.63	0.81	12.41	8.75	0.83	13.07	8.95	0.84
95	9.48	8.06	0.78	10.14	8.58	0.81	10.80	8.36	0.84	11.10	8.44	0.85	12.12	8.70	0.87	12.78	8.90	0.89
100	9.24	7.85	0.81	9.90	8.36	0.84	10.56	8.16	0.87	10.96	8.31	0.89	11.89	8.52	0.90	12.55	8.72	0.92
105	9.02	7.63	0.85	9.68	8.15	0.88	10.34	7.96	0.91	10.81	8.18	0.92	11.66	8.33	0.94	12.31	8.54	0.96
110	8.78	7.37	0.88	9.45	7.88	0.92	10.11	7.71	0.95	10.58	7.93	0.96	11.43	8.09	0.98	12.09	8.31	0.99
115	8.55	7.15	0.92	9.21	7.66	0.95	9.87	7.51	0.98	10.35	7.73	0.99	11.19	7.90	1.01	11.85	8.11	1.03
118	8.42	7.10	0.93	9.08	7.61	0.97	9.74	7.47	1.01	10.21	7.70	1.02	11.06	7.87	1.04	11.72	8.10	1.05
122	8.37	7.08	0.96	9.03	7.60	0.99	9.69	7.46	1.03	10.17	7.68	1.04	11.01	7.86	1.07	11.67	8.09	1.09

DB: Dry Bulb Temperature (°F) WB: Wet Bulb Temperature (°F) TC: Total Capacity (kBtu/h)
 SHC: Sensible Capacity (kBtu/h) PI: Power Input (kW) (includes compressor, indoor fan motor and outdoor fan motor)

- All capacities are net, evaporator fan motor heat is deducted.
- Cooling range can be extended from 5°F down to -4°F using the Low Ambient Wind Baffle Kit (sold separately).
- Grey shading indicates reference data. Operation outside of the verified temperature range is subject to decreased performance and / or safety interruption.

4. Direct interpolation is permissible. ☹ Do not extrapolate.

Capacity as rated: 0 ft. above sea level with 24.6 ft. of refrigerant piping. 0 ft. level difference between outdoor and indoor units.

Cooling capacity rating obtained with air entering the indoor unit at 80°F dry bulb (DB) and 67°F wet bulb (WB), and outdoor ambient conditions of 95°F dry bulb (DB) and 75°F wet bulb (WB).

COOLING CAPACITY

KSUDB181A (KNUDB181A / KUSXB181A)

Table 19: KSUDB181 (KNUDB181A / KUSXB181A) Cooling Capacities.

Outdoor Air Temp. (°F DB)	Indoor Air Temperature (°F DB / °F WB)																	
	68 / 57			72 / 61			77 / 64			80 / 67			86 / 72			90 / 75		
	TC	SHC	PI	TC	SHC	PI	TC	SHC	PI	TC	SHC	PI	TC	SHC	PI	TC	SHC	PI
-4	17.7	12.52	0.82	18.8	13.22	0.84	19.89	12.8	0.88	20.69	13.07	0.89	22.09	13.18	0.9	23.19	13.43	0.92
-0.4	17.69	12.59	0.83	18.79	13.3	0.85	19.88	12.88	0.89	20.68	13.15	0.9	22.08	13.26	0.91	23.18	13.51	0.93
5	17.67	12.7	0.84	18.77	13.42	0.87	19.87	12.99	0.9	20.66	13.26	0.91	22.06	13.38	0.93	23.16	13.63	0.95
10	17.66	12.8	0.85	18.76	13.52	0.88	19.85	13.09	0.91	20.64	13.37	0.93	22.05	13.48	0.94	23.14	13.74	0.96
15	17.65	12.9	0.86	18.74	13.63	0.89	19.84	13.2	0.93	20.63	13.47	0.94	22.03	13.59	0.96	23.12	13.85	0.98
20	17.63	13	0.88	18.73	13.74	0.91	19.82	13.3	0.94	20.61	13.58	0.95	22.01	13.69	0.97	23.11	13.95	0.99
25	17.62	13.1	0.89	18.71	13.84	0.92	19.81	13.4	0.96	20.6	13.69	0.97	22	13.8	0.98	23.09	14.06	1.01
30	17.6	13.2	0.9	18.7	13.95	0.93	19.79	13.51	0.97	20.58	13.79	0.98	21.98	13.91	1	23.07	14.17	1.02
35	17.59	13.3	0.91	18.68	14.05	0.95	19.78	13.61	0.98	20.57	13.9	0.99	21.96	14.01	1.01	23.05	14.28	1.03
40	17.58	13.41	0.93	18.67	14.16	0.96	19.76	13.71	1	20.55	14	1.01	21.94	14.12	1.03	23.04	14.39	1.05
45	17.56	13.51	0.94	18.66	14.27	0.97	19.75	13.81	1.01	20.53	14.1	1.02	21.93	14.22	1.04	23.02	14.49	1.06
50	17.55	13.6	0.95	18.64	14.37	0.99	19.73	13.92	1.02	20.52	14.21	1.04	21.91	14.33	1.06	23	14.6	1.08
55	17.54	13.7	0.96	18.63	14.48	1	19.72	14.02	1.04	20.5	14.31	1.05	21.89	14.43	1.07	22.98	14.71	1.09
60	17.52	13.8	0.98	18.61	14.58	1.01	19.7	14.12	1.05	20.49	14.42	1.06	21.88	14.54	1.08	22.97	14.81	1.11
65	17.51	13.9	0.99	18.6	14.69	1.03	19.69	14.22	1.06	20.47	14.52	1.08	21.86	14.64	1.1	22.95	14.92	1.12
70	17.50	14.00	1.00	18.58	14.79	1.04	19.67	14.32	1.08	20.46	14.62	1.09	21.84	14.75	1.11	22.93	15.03	1.13
75	17.08	13.77	1.06	18.16	14.57	1.10	19.24	14.12	1.14	20.03	14.43	1.15	21.41	14.57	1.17	22.50	14.86	1.20
80	16.66	13.54	1.11	17.74	14.34	1.15	18.82	13.91	1.20	19.60	14.23	1.21	20.98	14.38	1.23	22.06	14.68	1.26
85	16.24	13.29	1.17	17.32	14.10	1.21	18.40	13.70	1.26	19.17	14.02	1.27	20.55	14.19	1.29	21.63	14.50	1.32
90	15.82	13.04	1.22	16.90	13.85	1.27	17.97	13.48	1.31	18.75	13.80	1.33	20.12	13.99	1.36	21.20	14.31	1.38
95	15.37	12.90	1.28	16.44	13.73	1.32	17.51	13.37	1.37	18.00	13.50	1.385	19.65	13.92	1.41	20.72	14.24	1.44
100	14.99	12.56	1.33	16.06	13.38	1.38	17.13	13.05	1.42	17.77	13.29	1.44	19.28	13.62	1.47	20.35	13.95	1.50
105	14.62	12.21	1.39	15.69	13.03	1.43	16.76	12.74	1.48	17.53	13.08	1.50	18.90	13.32	1.53	19.97	13.66	1.56
110	14.24	11.79	1.43	15.32	12.61	1.49	16.39	12.34	1.54	17.16	12.69	1.56	18.53	12.94	1.59	19.60	13.29	1.62
115	13.87	11.44	1.49	14.94	12.26	1.54	16.01	12.02	1.60	16.79	12.37	1.62	18.15	12.63	1.65	19.22	12.98	1.68
118	13.65	11.36	1.52	14.72	12.18	1.58	15.79	11.95	1.64	16.56	12.31	1.66	17.93	12.59	1.69	19.00	12.95	1.72
122	13.57	11.33	1.57	14.64	12.16	1.62	15.71	11.93	1.68	16.49	12.29	1.70	17.85	12.57	1.74	18.92	12.94	1.77

Performance Data

DB: Dry Bulb Temperature (°F) WB: Wet Bulb Temperature (°F) TC: Total Capacity (kBtu/h)
 SHC: Sensible Capacity (kBtu/h) PI: Power Input (kW) (includes compressor, indoor fan motor and outdoor fan motor)

- All capacities are net, evaporator fan motor heat is deducted.
- Cooling range can be extended from 5°F down to -4°F using the Low Ambient Wind Baffle Kit (sold separately).
- Grey shading indicates reference data. Operation outside of the verified temperature range is subject to decreased performance and / or safety interruption.

4. Direct interpolation is permissible. ☹ Do not extrapolate.

Capacity as rated: 0 ft. above sea level with 24.6 ft. of refrigerant piping. 0 ft. level difference between outdoor and indoor units.

Cooling capacity rating obtained with air entering the indoor unit at 80°F dry bulb (DB) and 67°F wet bulb (WB), and outdoor ambient conditions of 95°F dry bulb (DB) and 75°F wet bulb (WB).

COOLING CAPACITY

KSSCB241A (KNSCB241A / KUSXB241A)

Table 20: KSSCB241A (KNSCB241A / KUSXB241A) Cooling Capacities.

Outdoor Air Temp. (°F DB)	Indoor Air Temperature (°F DB / °F WB)																	
	68 / 57			72 / 61			77 / 64			80 / 67			86 / 72			90 / 75		
	TC	SHC	PI	TC	SHC	PI	TC	SHC	PI	TC	SHC	PI	TC	SHC	PI	TC	SHC	PI
-4	22.62	18.25	1.05	24.02	19.28	1.08	25.42	18.66	1.12	26.43	19.06	1.13	28.23	19.22	1.16	29.63	19.58	1.18
-0.4	22.6	18.35	1.06	24.01	19.39	1.09	25.41	18.77	1.13	26.42	19.17	1.15	28.21	19.33	1.17	29.62	19.7	1.19
5	22.58	18.51	1.07	23.99	19.56	1.11	25.39	18.94	1.15	26.4	19.34	1.17	28.19	19.5	1.19	29.59	19.87	1.21
10	22.57	18.66	1.09	23.97	19.71	1.13	25.37	19.09	1.17	26.38	19.49	1.19	28.17	19.65	1.2	29.57	20.03	1.23
15	22.55	18.81	1.1	23.95	19.87	1.15	25.35	19.24	1.19	26.35	19.64	1.2	28.15	19.81	1.22	29.55	20.18	1.25
20	22.53	18.96	1.12	23.93	20.02	1.16	25.33	19.39	1.2	26.34	19.8	1.21	28.13	19.96	1.24	29.53	20.34	1.27
25	22.51	19.1	1.14	23.91	20.18	1.18	25.31	19.54	1.22	26.32	19.95	1.23	28.11	20.12	1.26	29.51	20.5	1.29
30	22.49	19.25	1.15	23.89	20.33	1.19	25.29	19.69	1.24	26.3	20.1	1.25	28.08	20.27	1.28	29.48	20.66	1.3
35	22.48	19.4	1.17	23.87	20.49	1.21	25.27	19.84	1.25	26.28	20.26	1.27	28.06	20.43	1.3	29.46	20.81	1.32
40	22.46	19.54	1.19	23.85	20.64	1.22	25.25	19.99	1.27	26.26	20.41	1.29	28.04	20.58	1.31	29.44	20.97	1.33
45	22.44	19.69	1.19	23.83	20.8	1.24	25.23	20.14	1.29	26.24	20.56	1.31	28.02	20.73	1.32	29.41	21.13	1.35
50	22.43	19.83	1.21	23.81	20.95	1.26	25.21	20.29	1.31	26.22	20.71	1.32	27.99	20.89	1.34	29.39	21.28	1.37
55	22.41	19.98	1.23	23.81	21.1	1.28	25.19	20.43	1.32	26.2	20.86	1.33	27.97	21.04	1.36	29.36	21.44	1.39
60	22.4	20.12	1.25	23.79	21.26	1.3	25.18	20.58	1.34	26.18	21.02	1.35	27.95	21.19	1.38	29.34	21.59	1.41
65	22.38	20.27	1.26	23.77	21.41	1.31	25.16	20.73	1.35	26.15	21.17	1.37	27.94	21.35	1.4	29.33	21.75	1.43
70	22.36	20.41	1.28	23.75	21.56	1.32	25.14	20.88	1.37	26.13	21.32	1.39	27.92	21.50	1.42	29.30	21.91	1.44
75	21.82	20.08	1.35	23.20	21.24	1.40	24.59	20.59	1.44	25.59	21.03	1.46	27.36	21.24	1.49	28.74	21.66	1.52
80	21.28	19.73	1.42	22.66	20.90	1.47	24.04	20.28	1.52	25.04	20.74	1.54	26.80	20.97	1.57	28.19	21.40	1.60
85	20.75	19.37	1.48	22.13	20.55	1.54	23.51	19.97	1.59	24.50	20.44	1.61	26.26	20.69	1.65	27.64	21.13	1.68
90	20.21	19.01	1.56	21.59	20.19	1.61	22.96	19.65	1.67	23.96	20.12	1.69	25.71	20.40	1.72	27.09	20.86	1.76
95	19.64	18.81	1.62	21.01	20.01	1.69	22.38	19.50	1.74	23.00	19.68	1.769	25.11	20.29	1.80	26.48	20.77	1.83
100	19.16	18.30	1.69	20.53	19.50	1.75	21.90	19.03	1.82	22.70	19.38	1.84	24.63	19.85	1.87	26.00	20.34	1.91
105	18.68	17.80	1.76	20.05	19.00	1.82	21.42	18.57	1.89	22.41	19.07	1.92	24.15	19.42	1.95	25.52	19.91	1.99
110	18.20	17.19	1.83	19.57	18.38	1.90	20.94	17.99	1.96	21.93	18.50	1.99	23.67	18.86	2.03	25.04	19.37	2.07
115	17.72	16.68	1.90	19.09	17.87	1.97	20.46	17.52	2.04	21.45	18.03	2.07	23.19	18.41	2.10	24.56	18.93	2.15
118	17.43	16.56	1.94	18.80	17.76	2.01	20.17	17.43	2.08	21.16	17.95	2.11	22.90	18.35	2.15	24.27	18.88	2.20
122	17.35	16.52	2.00	18.71	17.72	2.07	20.08	17.40	2.15	21.06	17.92	2.17	22.82	18.33	2.21	24.18	18.86	2.25

DB: Dry Bulb Temperature (°F) WB: Wet Bulb Temperature (°F) TC: Total Capacity (kBtu/h)

SHC: Sensible Capacity (kBtu/h) PI: Power Input (kW) (includes compressor, indoor fan motor and outdoor fan motor)

1. All capacities are net, evaporator fan motor heat is deducted.

2. Cooling range can be extended from 5°F down to -4°F using the Low Ambient Wind Baffle Kit (sold separately).

3. Grey shading indicates reference data. Operation outside of the verified temperature range is subject to decreased performance and / or safety interruption. .

4. Direct interpolation is permissible. ⚠ Do not extrapolate.

Capacity as rated: 0 ft. above sea level with 24.6 ft. of refrigerant piping. 0 ft. level difference between outdoor and indoor units.

Cooling capacity rating obtained with air entering the indoor unit at 80°F dry bulb (DB) and 67°F wet bulb (WB), and outdoor ambient conditions of 95°F dry bulb (DB) and 75°F wet bulb (WB).

COOLING CAPACITY

KSSCB301A (KNSCB301A / KUSXB301A)

Table 21: KSSCB301A (KNSCB301A / KUSXB301A) Cooling Capacities.

Outdoor Air Temp. (°F DB)	Indoor Air Temperature (°F DB / °F WB)																	
	68 / 57			72 / 61			77 / 64			80 / 67			86 / 72			90 / 75		
	TC	SHC	PI	TC	SHC	PI	TC	SHC	PI	TC	SHC	PI	TC	SHC	PI	TC	SHC	PI
-4	29.5	18.25	1.47	31.33	19.28	1.52	33.16	18.66	1.57	34.48	19.06	1.58	36.83	19.22	1.62	38.65	19.58	1.65
-0.4	29.48	18.35	1.48	31.31	19.39	1.53	33.14	18.77	1.58	34.46	19.17	1.61	36.8	19.33	1.64	38.64	19.7	1.67
5	29.45	18.51	1.51	31.29	19.56	1.56	33.11	18.94	1.61	34.44	19.34	1.64	36.78	19.5	1.66	38.6	19.87	1.7
10	29.44	18.66	1.53	31.26	19.71	1.58	33.09	19.09	1.64	34.41	19.49	1.66	36.74	19.65	1.69	38.58	20.03	1.73
15	29.41	18.81	1.55	31.24	19.87	1.61	33.06	19.24	1.66	34.38	19.64	1.69	36.71	19.81	1.71	38.54	20.18	1.75
20	29.39	18.96	1.57	31.21	20.02	1.62	33.04	19.39	1.69	34.35	19.8	1.7	36.69	19.96	1.74	38.51	20.34	1.78
25	29.36	19.1	1.6	31.19	20.18	1.65	33.01	19.54	1.71	34.33	19.95	1.73	36.66	20.12	1.77	38.49	20.5	1.8
30	29.34	19.25	1.61	31.16	20.33	1.67	32.99	19.69	1.74	34.3	20.1	1.75	36.63	20.27	1.79	38.45	20.66	1.82
35	29.33	19.4	1.64	31.14	20.49	1.7	32.96	19.84	1.75	34.28	20.26	1.78	36.6	20.43	1.82	38.43	20.81	1.84
40	29.3	19.54	1.66	31.11	20.64	1.71	32.94	19.99	1.78	34.25	20.41	1.8	36.58	20.58	1.83	38.4	20.97	1.87
45	29.28	19.69	1.67	31.09	20.8	1.74	32.91	20.14	1.8	34.23	20.56	1.83	36.55	20.73	1.86	38.36	21.13	1.9
50	29.25	19.83	1.7	31.06	20.95	1.77	32.89	20.29	1.83	34.2	20.71	1.86	36.51	20.89	1.88	38.34	21.28	1.92
55	29.23	19.98	1.73	31.05	21.1	1.79	32.86	20.43	1.86	34.18	20.86	1.87	36.49	21.04	1.91	38.3	21.44	1.95
60	29.21	20.12	1.75	31.03	21.26	1.82	32.84	20.58	1.88	34.15	21.02	1.9	36.46	21.19	1.93	38.28	21.59	1.97
65	29.19	20.27	1.77	31	21.41	1.83	32.81	20.73	1.9	34.11	21.17	1.92	36.44	21.35	1.96	38.25	21.75	2
70	29.16	20.41	1.79	30.98	21.56	1.86	32.79	20.88	1.92	34.09	21.32	1.95	36.41	21.50	1.99	38.21	21.91	2.03
75	28.46	20.08	1.90	30.26	21.24	1.96	32.08	20.59	2.03	33.38	21.03	2.05	35.69	21.24	2.09	37.49	21.66	2.13
80	27.76	19.73	1.99	29.56	20.90	2.06	31.36	20.28	2.13	32.66	20.74	2.16	34.96	20.97	2.19	36.78	21.40	2.25
85	27.06	19.37	2.08	28.86	20.55	2.16	30.66	19.97	2.23	31.96	20.44	2.26	34.25	20.69	2.31	36.05	21.13	2.35
90	26.36	19.01	2.18	28.16	20.19	2.26	29.95	19.65	2.34	31.25	20.12	2.36	33.54	20.40	2.42	35.34	20.86	2.47
95	25.61	18.81	2.27	27.40	20.01	2.36	29.19	19.50	2.44	30.00	19.68	2.48	32.75	20.29	2.52	34.54	20.77	2.57
100	24.99	18.30	2.38	26.78	19.50	2.45	28.56	19.03	2.54	29.61	19.38	2.58	32.13	19.85	2.62	33.91	20.34	2.67
105	24.36	17.80	2.47	26.15	19.00	2.56	27.94	18.57	2.65	29.23	19.07	2.69	31.50	19.42	2.74	33.29	19.91	2.79
110	23.74	17.19	2.57	25.53	18.38	2.66	27.31	17.99	2.75	28.60	18.50	2.79	30.88	18.86	2.84	32.66	19.37	2.90
115	23.11	16.68	2.66	24.90	17.87	2.77	26.69	17.52	2.86	27.98	18.03	2.90	30.25	18.41	2.95	32.04	18.93	3.01
118	22.74	16.56	2.73	24.53	17.76	2.82	26.31	17.43	2.92	27.60	17.95	2.96	29.88	18.35	3.01	31.66	18.88	3.08
122	22.63	16.52	2.80	24.40	17.72	2.90	26.19	17.40	3.01	27.48	17.92	3.04	29.76	18.33	3.10	31.54	18.86	3.16

Performance Data

DB: Dry Bulb Temperature (°F) WB: Wet Bulb Temperature (°F) TC: Total Capacity (kBtu/h)

SHC: Sensible Capacity (kBtu/h) PI: Power Input (kW) (includes compressor, indoor fan motor and outdoor fan motor)

- All capacities are net, evaporator fan motor heat is deducted.
- Cooling range can be extended from 5°F down to -4°F using the Low Ambient Wind Baffle Kit (sold separately).
- Grey shading indicates reference data. Operation outside of the verified temperature range is subject to decreased performance and / or safety interruption.

4. Direct interpolation is permissible. ⚠ Do not extrapolate.

Capacity as rated: 0 ft. above sea level with 24.6 ft. of refrigerant piping. 0 ft. level difference between outdoor and indoor units.

Cooling capacity rating obtained with air entering the indoor unit at 80°F dry bulb (DB) and 67°F wet bulb (WB), and outdoor ambient conditions of 95°F dry bulb (DB) and 75°F wet bulb (WB).

COOLING CAPACITY

KSSCB361A (KNSCB361A / KUSXB361A)

Table 22: KSSCB361A (KNSCB361A / KUSXB361A) Cooling Capacities.

Outdoor Air Temp. (°F DB)	Indoor Air Temperature (°F DB / °F WB)																	
	68 / 57			72 / 61			77 / 64			80 / 67			86 / 72			90 / 75		
	TC	SHC	PI	TC	SHC	PI	TC	SHC	PI	TC	SHC	PI	TC	SHC	PI	TC	SHC	PI
-4	35.40	25.55	1.63	37.60	26.98	1.69	39.78	26.12	1.77	41.38	26.67	1.79	44.18	26.90	1.81	46.38	27.41	1.85
-0.4	35.38	25.69	1.65	37.58	27.14	1.71	39.76	26.28	1.79	41.36	26.84	1.81	44.16	27.06	1.83	46.36	27.57	1.87
5	35.34	25.92	1.69	37.54	27.39	1.75	39.74	26.51	1.81	41.32	27.06	1.83	44.12	27.31	1.87	46.32	27.82	1.91
10	35.32	26.12	1.71	37.52	27.59	1.77	39.70	26.71	1.83	41.28	27.28	1.87	44.10	27.51	1.89	46.28	28.04	1.93
15	35.30	26.33	1.73	37.48	27.82	1.79	39.68	26.94	1.87	41.26	27.49	1.89	44.06	27.73	1.93	46.24	28.26	1.96
20	35.26	26.53	1.77	37.46	28.04	1.83	39.64	27.14	1.89	41.22	27.71	1.91	44.02	27.94	1.94	46.22	28.47	1.98
25	35.24	26.73	1.79	37.42	28.24	1.85	39.62	27.35	1.93	41.20	27.94	1.94	44.00	28.16	1.96	46.18	28.69	2.02
30	35.20	26.94	1.81	37.40	28.47	1.87	39.58	27.57	1.94	41.16	28.14	1.96	43.96	28.39	2.00	46.14	28.92	2.04
35	35.18	27.14	1.83	37.36	28.67	1.91	39.56	27.77	1.96	41.14	28.37	1.98	43.92	28.59	2.02	46.10	29.14	2.06
40	35.16	27.37	1.87	37.34	28.90	1.93	39.52	27.98	2.00	41.10	28.57	2.02	43.88	28.82	2.06	46.08	29.37	2.10
45	35.12	27.57	1.89	37.32	29.12	1.94	39.50	28.18	2.02	41.06	28.77	2.04	43.86	29.02	2.08	46.04	29.57	2.12
50	35.10	27.75	1.91	37.28	29.33	1.98	39.46	28.41	2.04	41.04	29.00	2.08	43.82	29.24	2.12	46.00	29.79	2.16
55	35.08	27.96	1.93	37.26	29.55	2.00	39.44	28.61	2.08	41.00	29.20	2.10	43.78	29.45	2.14	45.96	30.02	2.18
60	35.04	28.16	1.96	37.22	29.75	2.02	39.40	28.82	2.10	40.98	29.43	2.12	43.76	29.67	2.16	45.94	30.22	2.22
65	35.02	28.37	1.98	37.20	29.98	2.06	39.38	29.02	2.12	40.94	29.63	2.16	43.72	29.88	2.20	45.90	30.45	2.24
70	35.00	28.57	2.00	37.16	30.18	2.08	39.34	29.22	2.16	40.92	29.84	2.18	43.68	30.10	2.22	45.86	30.67	2.26
75	34.16	28.10	2.12	36.32	29.73	2.20	38.48	28.82	2.28	40.06	29.45	2.30	42.82	29.73	2.34	45.00	30.33	2.40
80	33.32	27.63	2.22	35.48	29.26	2.30	37.64	28.39	2.40	39.20	29.04	2.42	41.96	29.35	2.46	44.12	29.96	2.51
85	32.48	27.12	2.34	34.64	28.77	2.42	36.80	27.96	2.51	38.34	28.61	2.53	41.10	28.96	2.57	43.26	29.59	2.63
90	31.64	26.61	2.44	33.80	28.26	2.53	35.94	27.51	2.61	37.50	28.16	2.65	40.24	28.55	2.71	42.40	29.20	2.75
95	30.74	26.33	2.55	32.88	28.02	2.63	35.02	27.28	2.73	36.00	27.55	2.77	39.30	28.41	2.83	41.44	29.06	2.89
100	29.98	25.63	2.65	32.12	27.31	2.75	34.26	26.63	2.85	35.54	27.12	2.89	38.56	27.79	2.95	40.70	28.47	3.01
105	29.24	24.92	2.77	31.38	26.59	2.87	33.52	26.00	2.97	35.06	26.69	3.01	37.80	27.18	3.06	39.94	27.88	3.12
110	28.48	24.06	2.87	30.64	25.73	2.99	32.78	25.18	3.08	34.32	25.90	3.12	37.06	26.41	3.18	39.20	27.12	3.24
115	27.74	23.35	2.99	29.88	25.02	3.08	32.02	24.53	3.20	33.58	25.24	3.24	36.30	25.77	3.30	38.44	26.49	3.36
118	27.30	23.18	3.05	29.44	24.86	3.16	31.58	24.39	3.28	33.12	25.12	3.32	35.86	25.69	3.38	38.00	26.43	3.44
122	27.14	23.12	3.14	29.28	24.82	3.24	31.42	24.35	3.36	32.98	25.08	3.40	35.70	25.65	3.48	37.84	26.41	3.54

DB: Dry Bulb Temperature (°F) WB: Wet Bulb Temperature (°F) TC: Total Capacity (kBtu/h)

SHC: Sensible Capacity (kBtu/h) PI: Power Input (kW) (includes compressor, indoor fan motor and outdoor fan motor)

- All capacities are net, evaporator fan motor heat is deducted.
- Cooling range can be extended from 5°F down to -4°F using the Low Ambient Wind Baffle Kit (sold separately).
- Grey shading indicates reference data. Operation outside of the verified temperature range is subject to decreased performance and / or safety interruption. .

4. Direct interpolation is permissible. ⚠ Do not extrapolate.

Capacity as rated: 0 ft. above sea level with 24.6 ft. of refrigerant piping. 0 ft. level difference between outdoor and indoor units.

Cooling capacity rating obtained with air entering the indoor unit at 80°F dry bulb (DB) and 67°F wet bulb (WB), and outdoor ambient conditions of 95°F dry bulb (DB) and 75°F wet bulb (WB).

COOLING CAPACITY

KSSCB421A (KNSCB421A / KUSXB421A)

Table 23: KSSCB421A (KNSCB421A / KUSXB421A) Cooling Capacities.

Outdoor Air Temp. (°F DB)	Indoor Air Temperature (°F DB / °F WB)																	
	68 / 57			72 / 61			77 / 64			80 / 67			86 / 72			90 / 75		
	TC	SHC	PI	TC	SHC	PI	TC	SHC	PI	TC	SHC	PI	TC	SHC	PI	TC	SHC	PI
-4	41.30	31.17	1.87	43.87	32.91	1.94	46.41	31.87	2.03	48.28	32.54	2.05	51.54	32.81	2.07	54.11	33.44	2.12
-0.4	41.28	31.34	1.89	43.84	33.11	1.96	46.39	32.07	2.05	48.25	32.74	2.07	51.52	33.01	2.10	54.09	33.63	2.14
5	41.23	31.62	1.94	43.80	33.41	2.01	46.36	32.34	2.07	48.21	33.01	2.10	51.47	33.31	2.14	54.04	33.93	2.19
10	41.21	31.87	1.96	43.77	33.66	2.03	46.32	32.59	2.10	48.16	33.29	2.14	51.45	33.56	2.17	53.99	34.21	2.21
15	41.18	32.12	1.98	43.73	33.93	2.05	46.29	32.86	2.14	48.14	33.54	2.17	51.40	33.83	2.21	53.95	34.48	2.26
20	41.14	32.37	2.03	43.70	34.21	2.10	46.25	33.11	2.17	48.09	33.81	2.19	51.36	34.08	2.23	53.92	34.73	2.28
25	41.11	32.61	2.05	43.66	34.46	2.12	46.22	33.36	2.21	48.07	34.08	2.23	51.33	34.36	2.26	53.88	35.00	2.32
30	41.07	32.86	2.07	43.63	34.73	2.14	46.18	33.63	2.23	48.02	34.33	2.26	51.29	34.63	2.30	53.83	35.28	2.35
35	41.04	33.11	2.10	43.59	34.98	2.19	46.15	33.88	2.26	48.00	34.61	2.28	51.24	34.88	2.32	53.78	35.55	2.37
40	41.02	33.39	2.14	43.56	35.25	2.21	46.11	34.13	2.30	47.95	34.85	2.32	51.19	35.15	2.37	53.76	35.83	2.41
45	40.97	33.63	2.17	43.54	35.53	2.23	46.08	34.38	2.32	47.90	35.10	2.35	51.17	35.40	2.39	53.71	36.07	2.44
50	40.95	33.86	2.19	43.49	35.78	2.28	46.04	34.66	2.35	47.88	35.38	2.39	51.12	35.68	2.44	53.67	36.35	2.48
55	40.93	34.11	2.21	43.47	36.05	2.30	46.01	34.90	2.39	47.83	35.63	2.41	51.08	35.93	2.46	53.62	36.62	2.50
60	40.88	34.36	2.26	43.42	36.30	2.32	45.97	35.15	2.41	47.81	35.90	2.44	51.05	36.20	2.48	53.60	36.87	2.55
65	40.86	34.61	2.28	43.40	36.57	2.37	45.94	35.40	2.44	47.76	36.15	2.48	51.01	36.45	2.53	53.55	37.15	2.57
70	40.83	34.85	2.30	43.35	36.82	2.39	45.90	35.65	2.48	47.74	36.40	2.50	50.96	36.72	2.55	53.50	37.42	2.59
75	39.85	34.28	2.44	42.37	36.27	2.53	44.89	35.15	2.62	46.74	35.93	2.64	49.96	36.27	2.68	52.50	37.00	2.75
80	38.87	33.71	2.55	41.39	35.70	2.64	43.91	34.63	2.75	45.73	35.43	2.77	48.95	35.80	2.82	51.47	36.55	2.89
85	37.89	33.09	2.68	40.41	35.10	2.77	42.93	34.11	2.89	44.73	34.90	2.91	47.95	35.33	2.95	50.47	36.10	3.02
90	36.91	32.46	2.80	39.43	34.48	2.91	41.93	33.56	3.00	43.75	34.36	3.04	46.95	34.83	3.11	49.47	35.63	3.16
95	35.86	32.12	2.93	38.36	34.18	3.02	40.86	33.29	3.13	42.00	33.61	3.18	45.85	34.66	3.25	48.35	35.45	3.32
100	34.98	31.27	3.04	37.47	33.31	3.16	39.97	32.49	3.27	41.46	33.09	3.32	44.99	33.91	3.38	47.48	34.73	3.45
105	34.11	30.40	3.18	36.61	32.44	3.29	39.11	31.72	3.41	40.90	32.56	3.45	44.10	33.16	3.52	46.60	34.01	3.59
110	33.23	29.35	3.29	35.75	31.39	3.43	38.24	30.72	3.54	40.04	31.59	3.59	43.24	32.22	3.65	45.73	33.09	3.72
115	32.36	28.48	3.43	34.86	30.52	3.54	37.36	29.93	3.68	39.18	30.80	3.72	42.35	31.44	3.79	44.85	32.32	3.86
118	31.85	28.28	3.50	34.35	30.32	3.63	36.84	29.75	3.77	38.64	30.65	3.81	41.84	31.34	3.88	44.33	32.24	3.95
122	31.66	28.21	3.61	34.16	30.27	3.72	36.66	29.70	3.86	38.48	30.60	3.90	41.65	31.29	3.99	44.15	32.22	4.06

Performance Data

DB: Dry Bulb Temperature (°F) WB: Wet Bulb Temperature (°F) TC: Total Capacity (kBtu/h)

SHC: Sensible Capacity (kBtu/h) PI: Power Input (kW) (includes compressor, indoor fan motor and outdoor fan motor)

- All capacities are net, evaporator fan motor heat is deducted.
- Cooling range can be extended from 5°F down to -4°F using the Low Ambient Wind Baffle Kit (sold separately).
- Grey shading indicates reference data. Operation outside of the verified temperature range is subject to decreased performance and / or safety interruption.

4. Direct interpolation is permissible. ⚠ Do not extrapolate.

Capacity as rated: 0 ft. above sea level with 24.6 ft. of refrigerant piping. 0 ft. level difference between outdoor and indoor units.

Cooling capacity rating obtained with air entering the indoor unit at 80°F dry bulb (DB) and 67°F wet bulb (WB), and outdoor ambient conditions of 95°F dry bulb (DB) and 75°F wet bulb (WB).

COOLING CAPACITY

KSSCB481A (KNSCB481A / KUSXB481A)

Table 24: KSSCB481A (KNSCB481A / KUSXB481A) Cooling Capacities.

Outdoor Air Temp. (°F DB)	Indoor Air Temperature (°F DB / °F WB)																	
	68 / 57			72 / 61			77 / 64			80 / 67			86 / 72			90 / 75		
	TC	SHC	PI	TC	SHC	PI	TC	SHC	PI	TC	SHC	PI	TC	SHC	PI	TC	SHC	PI
-4	47.20	33.56	2.34	50.13	35.44	2.42	53.04	34.31	2.53	55.17	35.04	2.56	58.91	35.33	2.59	61.84	36.00	2.65
-0.4	47.17	33.75	2.37	50.11	35.65	2.45	53.01	34.53	2.56	55.15	35.25	2.59	58.88	35.55	2.62	61.81	36.22	2.67
5	47.12	34.05	2.42	50.05	35.98	2.51	52.99	34.82	2.59	55.09	35.55	2.62	58.83	35.87	2.67	61.76	36.54	2.73
10	47.09	34.31	2.45	50.03	36.24	2.53	52.93	35.09	2.62	55.04	35.84	2.67	58.80	36.14	2.70	61.71	36.83	2.76
15	47.07	34.58	2.48	49.97	36.54	2.56	52.91	35.39	2.67	55.01	36.11	2.70	58.75	36.43	2.76	61.65	37.13	2.82
20	47.01	34.85	2.53	49.95	36.83	2.62	52.85	35.65	2.70	54.96	36.40	2.73	58.69	36.70	2.79	61.63	37.40	2.84
25	46.99	35.12	2.56	49.89	37.10	2.65	52.83	35.92	2.76	54.93	36.70	2.79	58.67	36.99	2.82	61.57	37.69	2.90
30	46.93	35.39	2.59	49.87	37.40	2.67	52.77	36.22	2.79	54.88	36.97	2.82	58.61	37.29	2.87	61.52	37.99	2.93
35	46.91	35.65	2.62	49.81	37.66	2.73	52.75	36.48	2.82	54.85	37.26	2.84	58.56	37.56	2.90	61.47	38.28	2.96
40	46.88	35.95	2.67	49.79	37.96	2.76	52.69	36.75	2.87	54.80	37.53	2.90	58.51	37.85	2.96	61.44	38.58	3.01
45	46.83	36.22	2.70	49.76	38.25	2.79	52.67	37.02	2.90	54.75	37.80	2.93	58.48	38.12	2.98	61.39	38.84	3.04
50	46.80	36.46	2.73	49.71	38.52	2.84	52.61	37.32	2.93	54.72	38.09	2.98	58.43	38.42	3.04	61.33	39.14	3.10
55	46.77	36.73	2.76	49.68	38.82	2.87	52.59	37.58	2.98	54.67	38.36	3.01	58.37	38.68	3.07	61.28	39.43	3.13
60	46.72	36.99	2.82	49.63	39.09	2.90	52.53	37.85	3.01	54.64	38.66	3.04	58.35	38.98	3.10	61.25	39.70	3.18
65	46.69	37.26	2.84	49.60	39.38	2.96	52.51	38.12	3.04	54.59	38.92	3.10	58.29	39.25	3.15	61.20	40.00	3.21
70	46.67	37.53	2.87	49.55	39.65	2.98	52.45	38.39	3.10	54.56	39.19	3.13	58.24	39.54	3.18	61.15	40.29	3.24
75	45.55	36.91	3.04	48.43	39.06	3.15	51.31	37.85	3.27	53.41	38.68	3.29	57.09	39.06	3.35	60.00	39.84	3.44
80	44.43	36.30	3.18	47.31	38.44	3.29	50.19	37.29	3.44	52.27	38.15	3.46	55.95	38.55	3.52	58.83	39.35	3.60
85	43.31	35.63	3.35	46.19	37.80	3.46	49.07	36.73	3.60	51.12	37.58	3.63	54.80	38.04	3.69	57.68	38.87	3.77
90	42.19	34.96	3.49	45.07	37.13	3.63	47.92	36.14	3.74	50.00	36.99	3.80	53.65	37.50	3.89	56.53	38.36	3.94
95	40.99	34.58	3.66	43.84	36.81	3.77	46.69	35.84	3.91	48.00	36.19	3.97	52.40	37.32	4.05	55.25	38.17	4.14
100	39.97	33.67	3.80	42.83	35.87	3.94	45.68	34.98	4.08	47.39	35.63	4.14	51.41	36.51	4.22	54.27	37.40	4.31
105	38.99	32.73	3.97	41.84	34.93	4.11	44.69	34.15	4.25	46.75	35.06	4.31	50.40	35.71	4.39	53.25	36.62	4.48
110	37.97	31.61	4.11	40.85	33.80	4.28	43.71	33.08	4.42	45.76	34.02	4.48	49.41	34.69	4.56	52.27	35.63	4.65
115	36.99	30.67	4.28	39.84	32.87	4.42	42.69	32.22	4.59	44.77	33.16	4.65	48.40	33.86	4.73	51.25	34.80	4.81
118	36.40	30.45	4.36	39.25	32.65	4.53	42.11	32.03	4.70	44.16	33.00	4.76	47.81	33.75	4.84	50.67	34.72	4.93
122	36.19	30.37	4.50	39.04	32.60	4.65	41.89	31.98	4.81	43.97	32.95	4.87	47.60	33.70	4.98	50.45	34.69	5.07

DB: Dry Bulb Temperature (°F) WB: Wet Bulb Temperature (°F) TC: Total Capacity (kBtu/h)

SHC: Sensible Capacity (kBtu/h) PI: Power Input (kW) (includes compressor, indoor fan motor and outdoor fan motor)

1. All capacities are net, evaporator fan motor heat is deducted.

2. Cooling range can be extended from 5°F down to -4°F using the Low Ambient Wind Baffle Kit (sold separately).

3. Grey shading indicates reference data. Operation outside of the verified temperature range is subject to decreased performance and / or safety interruption. .

4. Direct interpolation is permissible. ⚠ Do not extrapolate.

Capacity as rated: 0 ft. above sea level with 24.6 ft. of refrigerant piping. 0 ft. level difference between outdoor and indoor units.

Cooling capacity rating obtained with air entering the indoor unit at 80°F dry bulb (DB) and 67°F wet bulb (WB), and outdoor ambient conditions of 95°F dry bulb (DB) and 75°F wet bulb (WB).

MAXIMUM COOLING CAPACITY

KSUDB091A (KNUDB091A / KUSXB091A)

Table 25: KSUDB091A (KNUDB091A / KUSXB091A) Maximum Cooling Capacities.

Outdoor Air Temp. (°F DB)	Indoor Air Temperature (°F DB / °F WB)																	
	68 / 57			72 / 61			77 / 64			80 / 67			86 / 72			90 / 75		
	TC	SHC	PI	TC	SHC	PI	TC	SHC	PI	TC	SHC	PI	TC	SHC	PI	TC	SHC	PI
-4	9.73	7.57	0.49	10.34	7.99	0.51	10.94	7.74	0.53	11.38	7.90	0.53	12.15	7.97	0.54	12.75	8.12	0.55
-0.4	9.73	7.61	0.50	10.33	8.04	0.52	10.94	7.79	0.53	11.37	7.95	0.54	12.14	8.02	0.55	12.75	8.17	0.56
5	9.72	7.68	0.50	10.32	8.11	0.52	10.93	7.85	0.54	11.36	8.02	0.55	12.14	8.09	0.56	12.74	8.24	0.57
10	9.71	7.74	0.51	10.32	8.18	0.53	10.92	7.92	0.55	11.35	8.08	0.56	12.12	8.15	0.57	12.73	8.31	0.58
15	9.70	7.80	0.52	10.31	8.24	0.54	10.91	7.98	0.56	11.35	8.15	0.56	12.12	8.21	0.57	12.72	8.37	0.59
20	9.70	7.86	0.53	10.30	8.30	0.55	10.90	8.04	0.56	11.34	8.21	0.57	12.11	8.28	0.58	12.71	8.43	0.59
25	9.69	7.92	0.53	10.29	8.37	0.55	10.89	8.11	0.57	11.33	8.27	0.58	12.10	8.35	0.59	12.70	8.50	0.60
30	9.68	7.98	0.54	10.28	8.43	0.56	10.89	8.17	0.58	11.32	8.34	0.59	12.09	8.41	0.60	12.69	8.57	0.61
35	9.68	8.04	0.55	10.28	8.50	0.57	10.88	8.23	0.59	11.31	8.40	0.60	12.08	8.47	0.61	12.68	8.63	0.62
40	9.67	8.11	0.56	10.27	8.56	0.58	10.87	8.29	0.60	11.30	8.46	0.61	12.07	8.53	0.62	12.67	8.70	0.63
45	9.66	8.17	0.56	10.26	8.63	0.59	10.86	8.35	0.61	11.29	8.53	0.61	12.06	8.60	0.62	12.66	8.76	0.64
50	9.65	8.22	0.57	10.25	8.69	0.59	10.85	8.41	0.61	11.29	8.59	0.62	12.05	8.67	0.63	12.65	8.82	0.65
55	9.64	8.28	0.58	10.24	8.75	0.60	10.84	8.48	0.62	11.28	8.65	0.63	12.04	8.73	0.64	12.64	8.89	0.66
60	9.64	8.35	0.59	10.24	8.82	0.61	10.83	8.54	0.63	11.27	8.72	0.64	12.03	8.79	0.65	12.63	8.96	0.66
65	9.63	8.41	0.59	10.23	8.88	0.61	10.83	8.60	0.64	11.26	8.78	0.65	12.02	8.85	0.66	12.62	9.02	0.67
70	9.62	8.47	0.60	10.22	8.94	0.62	10.82	8.66	0.65	11.25	8.84	0.65	12.02	8.91	0.67	12.61	9.08	0.68
75	9.39	8.33	0.63	9.99	8.81	0.66	10.58	8.54	0.68	11.01	8.72	0.69	11.78	8.81	0.70	12.37	8.98	0.72
80	9.16	8.19	0.67	9.76	8.67	0.69	10.35	8.41	0.72	10.78	8.60	0.73	11.54	8.70	0.74	12.14	8.88	0.75
85	8.93	8.04	0.70	9.52	8.52	0.73	10.12	8.28	0.75	10.55	8.48	0.76	11.31	8.58	0.77	11.90	8.76	0.79
90	8.70	7.88	0.73	9.29	8.37	0.76	9.88	8.15	0.79	10.31	8.35	0.80	11.07	8.46	0.81	11.66	8.65	0.83
95	8.45	7.80	0.76	9.04	8.30	0.79	9.63	8.09	0.82	9.90	8.16	0.83	10.81	8.42	0.84	11.40	8.61	0.86
100	8.25	7.59	0.80	8.83	8.09	0.82	9.42	7.89	0.86	9.77	8.04	0.86	10.60	8.23	0.88	11.19	8.43	0.90
105	8.04	7.38	0.83	8.63	7.88	0.86	9.22	7.70	0.89	9.64	7.91	0.90	10.40	8.05	0.92	10.99	8.26	0.93
110	7.84	7.13	0.86	8.42	7.63	0.89	9.01	7.46	0.93	9.44	7.67	0.93	10.19	7.82	0.95	10.78	8.03	0.97
115	7.63	6.92	0.89	8.22	7.41	0.93	8.81	7.26	0.96	9.23	7.48	0.97	9.98	7.64	0.99	10.57	7.85	1.01
118	7.50	6.87	0.91	8.10	7.37	0.95	8.68	7.23	0.98	9.11	7.44	0.99	9.86	7.61	1.01	10.45	7.83	1.03
122	7.46	6.85	0.94	8.05	7.35	0.97	8.64	7.22	1.01	9.07	7.43	1.02	9.82	7.60	1.04	10.41	7.82	1.06

Performance Data

DB: Dry Bulb Temperature (°F) WB: Wet Bulb Temperature (°F) TC: Total Capacity (kBtu/h)

SHC: Sensible Capacity (kBtu/h) PI: Power Input (kW) (includes compressor, indoor fan motor and outdoor fan motor)

1. All capacities are net, evaporator fan motor heat is deducted.

2. Cooling range can be extended from 5°F down to -4°F using the Low Ambient Wind Baffle Kit (sold separately).

3. Grey shading indicates reference data. Operation outside of the verified temperature range is subject to decreased performance and / or safety interruption. .

4. Direct interpolation is permissible. ⚠ Do not extrapolate.

Capacity as rated: 0 ft. above sea level with 24.6 ft. of refrigerant piping. 0 ft. level difference between outdoor and indoor units.

Cooling capacity rating obtained with air entering the indoor unit at 80°F dry bulb (DB) and 67°F wet bulb (WB), and outdoor ambient conditions of 95°F dry bulb (DB) and 75°F wet bulb (WB).



MAXIMUM COOLING CAPACITY

KSUDB121A (KNUDB121A / KUSXB121A)

Table 26: KSUDB121A (KNUDB121A / KUSXB121A) Maximum Cooling Capacities.

Outdoor Air Temp. (°F DB)	Indoor Air Temperature (°F DB / °F WB)																	
	68 / 57			72 / 61			77 / 64			80 / 67			86 / 72			90 / 75		
	TC	SHC	PI	TC	SHC	PI	TC	SHC	PI	TC	SHC	PI	TC	SHC	PI	TC	SHC	PI
-4	12.19	8.74	0.65	12.95	9.23	0.68	13.71	8.94	0.70	14.25	9.13	0.71	15.22	9.21	0.72	15.98	9.38	0.73
-0.4	12.19	8.79	0.66	12.94	9.29	0.68	13.70	8.99	0.71	14.25	9.18	0.71	15.21	9.26	0.73	15.97	9.43	0.74
5	12.18	8.87	0.67	12.93	9.37	0.69	13.69	9.07	0.72	14.23	9.27	0.73	15.20	9.34	0.74	15.96	9.52	0.76
10	12.17	8.94	0.68	12.92	9.44	0.70	13.68	9.15	0.73	14.22	9.34	0.74	15.19	9.42	0.75	15.94	9.60	0.77
15	12.16	9.01	0.69	12.91	9.52	0.71	13.67	9.22	0.74	14.21	9.41	0.75	15.18	9.49	0.76	15.93	9.67	0.78
20	12.15	9.08	0.70	12.90	9.59	0.73	13.66	9.29	0.75	14.20	9.48	0.76	15.17	9.56	0.77	15.92	9.74	0.79
25	12.14	9.15	0.71	12.89	9.67	0.73	13.65	9.36	0.76	14.19	9.56	0.77	15.15	9.64	0.78	15.91	9.82	0.80
30	12.13	9.22	0.72	12.88	9.74	0.74	13.64	9.43	0.77	14.18	9.63	0.78	15.14	9.71	0.80	15.90	9.90	0.81
35	12.12	9.29	0.73	12.87	9.81	0.75	13.63	9.50	0.78	14.17	9.71	0.79	15.13	9.79	0.81	15.88	9.97	0.82
40	12.11	9.36	0.74	12.86	9.89	0.76	13.62	9.58	0.79	14.16	9.78	0.80	15.12	9.86	0.82	15.87	10.05	0.83
45	12.10	9.43	0.75	12.85	9.97	0.78	13.61	9.65	0.80	14.15	9.85	0.81	15.11	9.93	0.83	15.86	10.12	0.85
50	12.09	9.50	0.76	12.84	10.04	0.78	13.60	9.72	0.81	14.14	9.92	0.82	15.10	10.01	0.84	15.85	10.19	0.86
55	12.08	9.57	0.77	12.83	10.11	0.80	13.58	9.79	0.83	14.13	9.99	0.83	15.09	10.08	0.85	15.84	10.27	0.87
60	12.07	9.64	0.78	12.82	10.18	0.81	13.57	9.86	0.83	14.12	10.07	0.85	15.07	10.15	0.86	15.82	10.35	0.88
65	12.07	9.71	0.79	12.81	10.26	0.81	13.56	9.93	0.85	14.10	10.14	0.86	15.06	10.23	0.87	15.81	10.42	0.89
70	12.06	9.78	0.80	12.80	10.33	0.83	13.55	10.00	0.86	14.09	10.22	0.86	15.05	10.30	0.88	15.80	10.49	0.90
75	11.77	9.62	0.84	12.51	10.17	0.87	13.26	9.86	0.90	13.80	10.07	0.91	14.75	10.17	0.93	15.50	10.37	0.95
80	11.48	9.46	0.88	12.22	10.02	0.91	12.97	9.72	0.95	13.50	9.94	0.96	14.46	10.05	0.98	15.20	10.25	1.00
85	11.19	9.28	0.93	11.93	9.85	0.96	12.67	9.56	1.00	13.21	9.79	1.01	14.16	9.91	1.03	14.90	10.12	1.05
90	10.90	9.11	0.97	11.64	9.67	1.00	12.38	9.41	1.04	12.92	9.64	1.05	13.87	9.77	1.07	14.61	9.99	1.10
95	10.59	9.01	1.01	11.33	9.59	1.05	12.06	9.34	1.09	12.40	9.43	1.10	13.54	9.72	1.12	14.28	9.95	1.14
100	10.33	8.77	1.05	11.07	9.34	1.09	11.81	9.12	1.13	12.24	9.28	1.15	13.28	9.51	1.17	14.02	9.74	1.19
105	10.07	8.53	1.10	10.81	9.10	1.14	11.55	8.90	1.18	12.08	9.14	1.19	13.02	9.30	1.22	13.76	9.54	1.24
110	9.82	8.24	1.14	10.55	8.81	1.18	11.29	8.62	1.23	11.82	8.86	1.24	12.77	9.04	1.26	13.50	9.28	1.29
115	9.56	7.99	1.18	10.30	8.56	1.23	11.03	8.39	1.27	11.57	8.64	1.29	12.51	8.82	1.31	13.25	9.07	1.34
118	9.40	7.93	1.21	10.14	8.51	1.25	10.88	8.35	1.30	11.41	8.60	1.32	12.35	8.79	1.34	13.09	9.04	1.37
122	9.35	7.91	1.24	10.09	8.49	1.29	10.83	8.34	1.34	11.36	8.59	1.35	12.30	8.78	1.38	13.04	9.04	1.40

DB: Dry Bulb Temperature (°F) WB: Wet Bulb Temperature (°F) TC: Total Capacity (kBtu/h)
 SHC: Sensible Capacity (kBtu/h) PI: Power Input (kW) (includes compressor, indoor fan motor and outdoor fan motor)

- All capacities are net, evaporator fan motor heat is deducted.
- Cooling range can be extended from 5°F down to -4°F using the Low Ambient Wind Baffle Kit (sold separately).
- Grey shading indicates reference data. Operation outside of the verified temperature range is subject to decreased performance and / or safety interruption.

4. Direct interpolation is permissible. ⚠ Do not extrapolate.

Capacity as rated: 0 ft. above sea level with 24.6 ft. of refrigerant piping, 0 ft. level difference between outdoor and indoor units.

Cooling capacity rating obtained with air entering the indoor unit at 80°F dry bulb (DB) and 67°F wet bulb (WB), and outdoor ambient conditions of 95°F dry bulb (DB) and 75°F wet bulb (WB).

MAXIMUM COOLING CAPACITY

KSUDB181A (KNUDB181A / KUSXB181A)

Table 27: KSUDB181A (KNUDB181A / KUSXB181A) Maximum Cooling Capacities.

Outdoor Air Temp. (°F DB)	Indoor Air Temperature (°F DB / °F WB)																	
	68 / 57			72 / 61			77 / 64			80 / 67			86 / 72			90 / 75		
	TC	SHC	PI	TC	SHC	PI	TC	SHC	PI	TC	SHC	PI	TC	SHC	PI	TC	SHC	PI
-4	22.61	16.1	1.48	24.02	17	1.54	25.42	16.46	1.59	26.43	16.81	1.61	28.23	16.95	1.64	29.63	17.27	1.67
-0.4	22.6	16.19	1.49	24	17.1	1.55	25.41	16.56	1.61	26.42	16.91	1.62	28.21	17.05	1.66	29.62	17.37	1.69
5	22.58	16.33	1.52	23.98	17.25	1.58	25.38	16.7	1.63	26.39	17.06	1.65	28.19	17.2	1.68	29.59	17.53	1.72
10	22.56	16.46	1.54	23.96	17.39	1.6	25.36	16.84	1.66	26.38	17.19	1.68	28.17	17.34	1.71	29.57	17.67	1.75
15	22.55	16.59	1.56	23.95	17.53	1.62	25.35	16.97	1.68	26.36	17.33	1.7	28.15	17.47	1.73	29.55	17.8	1.76
20	22.53	16.72	1.59	23.93	17.66	1.65	25.33	17.1	1.7	26.34	17.46	1.73	28.13	17.61	1.75	29.53	17.94	1.79
25	22.51	16.85	1.61	23.91	17.8	1.67	25.31	17.24	1.73	26.32	17.6	1.75	28.1	17.75	1.78	29.5	18.08	1.82
30	22.5	16.98	1.63	23.89	17.94	1.69	25.29	17.37	1.75	26.3	17.73	1.77	28.08	17.88	1.81	29.48	18.22	1.84
35	22.48	17.11	1.66	23.87	18.07	1.71	25.27	17.5	1.78	26.27	17.87	1.8	28.06	18.02	1.83	29.45	18.36	1.87
40	22.46	17.24	1.68	23.85	18.21	1.74	25.25	17.63	1.8	26.26	18	1.82	28.05	18.15	1.86	29.44	18.5	1.89
45	22.44	17.37	1.7	23.83	18.35	1.76	25.24	17.76	1.82	26.24	18.14	1.85	28.02	18.29	1.88	29.41	18.64	1.92
50	22.43	17.49	1.72	23.82	18.48	1.78	25.22	17.89	1.85	26.22	18.27	1.87	28	18.43	1.9	29.39	18.77	1.95
55	22.41	17.62	1.75	23.8	18.62	1.81	25.19	18.03	1.88	26.2	18.4	1.89	27.98	18.56	1.93	29.37	18.91	1.97
60	22.39	17.75	1.76	23.78	18.75	1.83	25.17	18.16	1.89	26.18	18.54	1.92	27.95	18.69	1.96	29.34	19.05	1.99
65	22.38	17.88	1.79	23.76	18.89	1.85	25.15	18.29	1.92	26.15	18.67	1.95	27.93	18.83	1.98	29.33	19.19	2.02
70	22.36	18.01	1.82	23.74	19.02	1.88	25.13	18.42	1.95	26.13	18.81	1.96	27.92	18.96	2.01	29.30	19.32	2.04
75	21.82	17.71	1.91	23.20	18.73	1.98	24.59	18.16	2.05	25.59	18.55	2.08	27.36	18.73	2.11	28.74	19.10	2.16
80	21.28	17.41	2.01	22.67	18.44	2.08	24.05	17.89	2.16	25.04	18.30	2.18	26.81	18.50	2.22	28.19	18.88	2.26
85	20.75	17.09	2.11	22.13	18.13	2.18	23.50	17.61	2.26	24.50	18.03	2.29	26.26	18.25	2.33	27.64	18.64	2.38
90	20.22	16.77	2.20	21.59	17.81	2.28	22.96	17.33	2.37	23.96	17.75	2.39	25.72	17.99	2.44	27.09	18.40	2.49
95	19.63	16.59	2.30	21.01	17.65	2.39	22.37	17.20	2.47	23.00	17.36	2.50	25.11	17.90	2.54	26.48	18.32	2.60
100	19.16	16.15	2.39	20.52	17.20	2.48	21.90	16.79	2.58	22.70	17.09	2.61	24.63	17.51	2.66	26.00	17.94	2.71
105	18.68	15.70	2.50	20.05	16.76	2.59	21.41	16.38	2.68	22.41	16.82	2.71	24.15	17.13	2.76	25.52	17.57	2.82
110	18.21	15.17	2.60	19.57	16.22	2.68	20.94	15.87	2.79	21.92	16.32	2.82	23.68	16.64	2.87	25.04	17.08	2.93
115	17.72	14.71	2.69	19.10	15.76	2.79	20.46	15.45	2.89	21.45	15.90	2.92	23.19	16.24	2.98	24.57	16.70	3.04
118	17.44	14.61	2.75	18.81	15.67	2.85	20.17	15.37	2.96	21.16	15.83	2.99	22.91	16.19	3.04	24.28	16.65	3.11
122	17.34	14.57	2.82	18.71	15.63	2.93	20.08	15.35	3.04	21.06	15.81	3.07	22.81	16.17	3.13	24.18	16.64	3.19

Performance Data

DB: Dry Bulb Temperature (°F) WB: Wet Bulb Temperature (°F) TC: Total Capacity (kBtu/h)
 SHC: Sensible Capacity (kBtu/h) PI: Power Input (kW) (includes compressor, indoor fan motor and outdoor fan motor)

1. All capacities are net, evaporator fan motor heat is deducted.
2. Cooling range can be extended from 5°F down to -4°F using the Low Ambient Wind Baffle Kit (sold separately).
3. Grey shading indicates reference data. Operation outside of the verified temperature range is subject to decreased performance and / or safety interruption.

4. Direct interpolation is permissible. ⚠ Do not extrapolate.
 Capacity as rated: 0 ft. above sea level with 24.6 ft. of refrigerant piping. 0 ft. level difference between outdoor and indoor units.
 Cooling capacity rating obtained with air entering the indoor unit at 80°F dry bulb (DB) and 67°F wet bulb (WB), and outdoor ambient conditions of 95°F dry bulb (DB) and 75°F wet bulb (WB).



MAXIMUM COOLING CAPACITY

KSSCB241A (KNSCB241A / KUSXB241A)

Table 28: KSSCB241A (KNSCB241A / KUSXB241A) Maximum Cooling Capacities.

Outdoor Air Temp. (°F DB)	Indoor Air Temperature (°F DB / °F WB)																	
	68 / 57			72 / 61			77 / 64			80 / 67			86 / 72			90 / 75		
	TC	SHC	PI	TC	SHC	PI	TC	SHC	PI	TC	SHC	PI	TC	SHC	PI	TC	SHC	PI
-4	28.51	19.47	1.83	30.29	20.57	1.9	32.05	19.92	1.97	33.33	20.34	1.99	35.59	20.51	2.03	37.36	20.9	2.07
-0.4	28.5	19.59	1.85	30.27	20.69	1.92	32.04	20.03	1.99	33.31	20.45	2.02	35.57	20.63	2.06	37.34	21.02	2.1
5	28.47	19.76	1.88	30.24	20.87	1.95	32.01	20.21	2.03	33.28	20.63	2.05	35.54	20.81	2.09	37.31	21.2	2.13
10	28.45	19.91	1.91	30.22	21.04	1.98	31.99	20.37	2.06	33.26	20.8	2.08	35.52	20.97	2.12	37.28	21.37	2.16
15	28.43	20.07	1.94	30.2	21.2	2.02	31.96	20.53	2.09	33.23	20.96	2.11	35.49	21.14	2.15	37.26	21.54	2.19
20	28.41	20.23	1.96	30.17	21.37	2.04	31.94	20.69	2.12	33.21	21.12	2.14	35.47	21.3	2.18	37.23	21.71	2.22
25	28.38	20.38	1.99	30.15	21.53	2.07	31.91	20.85	2.14	33.19	21.29	2.17	35.44	21.47	2.21	37.2	21.87	2.25
30	28.36	20.54	2.03	30.12	21.7	2.1	31.89	21.01	2.17	33.16	21.45	2.2	35.41	21.63	2.24	37.17	22.04	2.28
35	28.34	20.7	2.06	30.1	21.86	2.13	31.86	21.17	2.2	33.14	21.61	2.23	35.38	21.8	2.27	37.14	22.21	2.31
40	28.32	20.85	2.08	30.08	22.03	2.16	31.84	21.33	2.23	33.11	21.78	2.26	35.35	21.96	2.3	37.11	22.38	2.35
45	28.29	21.01	2.11	30.05	22.19	2.18	31.81	21.49	2.26	33.08	21.94	2.29	35.33	22.13	2.34	37.08	22.54	2.38
50	28.28	21.16	2.14	30.03	22.36	2.21	31.79	21.65	2.29	33.06	22.1	2.33	35.3	22.29	2.37	37.06	22.71	2.41
55	28.26	21.32	2.16	30.01	22.52	2.24	31.76	21.81	2.33	33.03	22.26	2.35	35.27	22.45	2.4	37.03	22.88	2.44
60	28.24	21.47	2.19	29.99	22.68	2.27	31.74	21.96	2.36	33	22.43	2.38	35.24	22.61	2.43	37	23.04	2.47
65	28.21	21.63	2.22	29.97	22.85	2.3	31.72	22.12	2.39	32.98	22.59	2.41	35.22	22.78	2.46	36.98	23.21	2.5
70	28.19	21.78	2.24	29.94	23.01	2.33	31.69	22.28	2.42	32.95	22.75	2.44	35.2	22.94	2.49	36.95	23.37	2.54
75	27.51	21.42	2.37	29.26	22.66	2.46	31.00	21.97	2.54	32.27	22.45	2.57	34.50	22.66	2.62	36.24	23.11	2.68
80	26.83	21.06	2.49	28.57	22.30	2.58	30.31	21.65	2.68	31.57	22.14	2.71	33.80	22.38	2.76	35.54	22.84	2.81
85	26.16	20.67	2.61	27.90	21.93	2.71	29.64	21.31	2.80	30.89	21.81	2.84	33.11	22.07	2.89	34.85	22.55	2.95
90	25.49	20.28	2.73	27.22	21.54	2.83	28.95	20.96	2.93	30.21	21.47	2.97	32.42	21.77	3.03	34.15	22.26	3.09
95	24.76	20.07	2.85	26.49	21.35	2.96	28.21	20.80	3.07	29.00	21.00	3.10	31.66	21.65	3.16	33.38	22.16	3.22
100	24.16	19.53	2.98	25.88	20.81	3.08	27.61	20.31	3.19	28.62	20.67	3.23	31.06	21.18	3.30	32.78	21.70	3.36
105	23.56	18.99	3.10	25.28	20.27	3.20	27.00	19.81	3.33	28.25	20.35	3.36	30.45	20.72	3.43	32.18	21.25	3.49
110	22.95	18.35	3.21	24.68	19.62	3.34	26.40	19.20	3.45	27.65	19.74	3.49	29.85	20.13	3.57	31.57	20.67	3.64
115	22.35	17.80	3.34	24.07	19.07	3.46	25.80	18.69	3.59	27.05	19.24	3.63	29.25	19.65	3.70	30.97	20.20	3.77
118	21.98	17.67	3.41	23.71	18.95	3.53	25.43	18.60	3.67	26.68	19.15	3.71	28.88	19.58	3.77	30.61	20.14	3.85
122	21.87	17.62	3.50	23.59	18.91	3.64	25.32	18.56	3.77	26.56	19.12	3.81	28.77	19.56	3.89	30.49	20.12	3.96

DB: Dry Bulb Temperature (°F) WB: Wet Bulb Temperature (°F) TC: Total Capacity (kBtu/h)
 SHC: Sensible Capacity (kBtu/h) PI: Power Input (kW) (includes compressor, indoor fan motor and outdoor fan motor)

- All capacities are net, evaporator fan motor heat is deducted.
- Cooling range can be extended from 5°F down to -4°F using the Low Ambient Wind Baffle Kit (sold separately).
- Grey shading indicates reference data. Operation outside of the verified temperature range is subject to decreased performance and / or safety interruption. .

4. Direct interpolation is permissible. ⚠ Do not extrapolate.

Capacity as rated: 0 ft. above sea level with 24.6 ft. of refrigerant piping. 0 ft. level difference between outdoor and indoor units.

Cooling capacity rating obtained with air entering the indoor unit at 80°F dry bulb (DB) and 67°F wet bulb (WB), and outdoor ambient conditions of 95°F dry bulb (DB) and 75°F wet bulb (WB).

MAXIMUM COOLING CAPACITY

KSSCB301A (KNSCB301A / KUSXB301A)

Table 29: KSSCB301A (KNSCB301A / KUSXB301A) Maximum Cooling Capacities.

Outdoor Air Temp. (°F DB)	Indoor Air Temperature (°F DB / °F WB)																	
	68 / 57			72 / 61			77 / 64			80 / 67			86 / 72			90 / 75		
	TC	SHC	PI	TC	SHC	PI	TC	SHC	PI	TC	SHC	PI	TC	SHC	PI	TC	SHC	PI
-4	34.41	19.47	2.12	36.55	20.57	2.21	38.69	19.92	2.29	40.23	20.34	2.32	42.96	20.51	2.35	45.09	20.9	2.4
-0.4	34.39	19.59	2.15	36.53	20.69	2.23	38.66	20.03	2.32	40.2	20.45	2.34	42.93	20.63	2.39	45.07	21.02	2.44
5	34.36	19.76	2.18	36.49	20.87	2.27	38.63	20.21	2.35	40.17	20.63	2.38	42.9	20.81	2.42	45.03	21.2	2.47
10	34.34	19.91	2.22	36.47	21.04	2.3	38.61	20.37	2.39	40.15	20.8	2.41	42.86	20.97	2.46	45	21.37	2.51
15	34.31	20.07	2.26	36.45	21.2	2.34	38.57	20.53	2.42	40.11	20.96	2.45	42.83	21.14	2.5	44.96	21.54	2.54
20	34.29	20.23	2.28	36.41	21.37	2.36	38.55	20.69	2.46	40.08	21.12	2.48	42.81	21.3	2.53	44.93	21.71	2.58
25	34.25	20.38	2.32	36.39	21.53	2.4	38.51	20.85	2.48	40.05	21.29	2.52	42.77	21.47	2.57	44.89	21.87	2.62
30	34.23	20.54	2.35	36.35	21.7	2.44	38.49	21.01	2.52	40.02	21.45	2.56	42.74	21.63	2.6	44.86	22.04	2.65
35	34.21	20.7	2.39	36.33	21.86	2.47	38.45	21.17	2.56	39.99	21.61	2.59	42.7	21.8	2.64	44.82	22.21	2.69
40	34.18	20.85	2.41	36.31	22.03	2.51	38.43	21.33	2.59	39.96	21.78	2.63	42.67	21.96	2.68	44.79	22.38	2.72
45	34.15	21.01	2.45	36.27	22.19	2.53	38.4	21.49	2.63	39.92	21.94	2.66	42.64	22.13	2.71	44.75	22.54	2.76
50	34.13	21.16	2.48	36.25	22.36	2.57	38.37	21.65	2.66	39.9	22.1	2.7	42.61	22.29	2.75	44.73	22.71	2.8
55	34.1	21.32	2.51	36.21	22.52	2.6	38.34	21.81	2.7	39.87	22.26	2.72	42.57	22.45	2.78	44.7	22.88	2.83
60	34.08	21.47	2.54	36.19	22.68	2.64	38.3	21.96	2.74	39.83	22.43	2.76	42.54	22.61	2.82	44.66	23.04	2.87
65	34.04	21.63	2.58	36.17	22.85	2.68	38.28	22.12	2.77	39.81	22.59	2.8	42.5	22.78	2.86	44.63	23.21	2.9
70	34.02	21.78	2.60	36.13	23.01	2.70	38.24	22.28	2.81	39.77	22.75	2.83	42.48	22.94	2.89	44.59	23.37	2.95
75	33.20	21.42	2.75	35.32	22.66	2.86	37.42	21.97	2.95	38.94	22.45	2.99	41.64	22.66	3.05	43.74	23.11	3.11
80	32.39	21.06	2.89	34.49	22.30	3.00	36.59	21.65	3.11	38.10	22.14	3.14	40.80	22.38	3.20	42.90	22.84	3.26
85	31.57	20.67	3.04	33.67	21.93	3.14	35.77	21.31	3.25	37.29	21.81	3.30	39.96	22.07	3.36	42.06	22.55	3.42
90	30.77	20.28	3.17	32.85	21.54	3.29	34.94	20.96	3.41	36.46	21.47	3.44	39.13	21.77	3.52	41.22	22.26	3.59
95	29.88	20.07	3.31	31.97	21.35	3.43	34.04	20.80	3.56	35.00	21.00	3.60	38.21	21.65	3.67	40.29	22.16	3.74
100	29.16	19.53	3.46	31.23	20.81	3.58	33.32	20.31	3.71	34.55	20.67	3.76	37.49	21.18	3.83	39.56	21.70	3.90
105	28.43	18.99	3.60	30.51	20.27	3.72	32.59	19.81	3.86	34.09	20.35	3.90	36.75	20.72	3.98	38.84	21.25	4.06
110	27.70	18.35	3.73	29.79	19.62	3.88	31.86	19.20	4.01	33.37	19.74	4.06	36.03	20.13	4.14	38.10	20.67	4.22
115	26.97	17.80	3.88	29.05	19.07	4.02	31.14	18.69	4.16	32.64	19.24	4.21	35.30	19.65	4.30	37.38	20.20	4.38
118	26.53	17.67	3.96	28.62	18.95	4.10	30.70	18.60	4.26	32.20	19.15	4.31	34.86	19.58	4.38	36.95	20.14	4.48
122	26.39	17.62	4.07	28.47	18.91	4.22	30.56	18.56	4.38	32.06	19.12	4.43	34.72	19.56	4.51	36.80	20.12	4.60

Performance Data

DB: Dry Bulb Temperature (°F) WB: Wet Bulb Temperature (°F) TC: Total Capacity (kBtu/h)

SHC: Sensible Capacity (kBtu/h) PI: Power Input (kW) (includes compressor, indoor fan motor and outdoor fan motor)

1. All capacities are net, evaporator fan motor heat is deducted.

2. Cooling range can be extended from 5°F down to -4°F using the Low Ambient Wind Baffle Kit (sold separately).

3. Grey shading indicates reference data. Operation outside of the verified temperature range is subject to decreased performance and / or safety interruption. .

4. Direct interpolation is permissible. ⚠ Do not extrapolate.

Capacity as rated: 0 ft. above sea level with 24.6 ft. of refrigerant piping. 0 ft. level difference between outdoor and indoor units.

Cooling capacity rating obtained with air entering the indoor unit at 80°F dry bulb (DB) and 67°F wet bulb (WB), and outdoor ambient conditions of 95°F dry bulb (DB) and 75°F wet bulb (WB).

MAXIMUM COOLING CAPACITY

KSSCB361A (KNSCB361A / KUSXB361A)

Table 30: KSSCB361A (KNSCB361A / KUSXB361A) Maximum Cooling Capacities.

Outdoor Air Temp. (°F DB)	Indoor Air Temperature (°F DB / °F WB)																	
	68 / 57			72 / 61			77 / 64			80 / 67			86 / 72			90 / 75		
	TC	SHC	PI	TC	SHC	PI	TC	SHC	PI	TC	SHC	PI	TC	SHC	PI	TC	SHC	PI
-4	41.29	29.81	2.31	43.86	31.48	2.39	46.42	30.48	2.48	48.27	31.12	2.50	51.55	31.38	2.56	54.11	31.98	2.60
-0.4	41.27	29.98	2.33	43.83	31.66	2.42	46.40	30.66	2.50	48.25	31.31	2.53	51.52	31.57	2.59	54.09	32.16	2.64
5	41.24	30.23	2.37	43.80	31.94	2.46	46.35	30.92	2.55	48.20	31.59	2.57	51.48	31.85	2.63	54.04	32.46	2.68
10	41.20	30.48	2.41	43.76	32.20	2.49	46.32	31.18	2.59	48.16	31.83	2.61	51.43	32.10	2.67	53.99	32.72	2.72
15	41.17	30.72	2.44	43.73	32.46	2.53	46.28	31.42	2.63	48.13	32.09	2.65	51.40	32.35	2.70	53.96	32.96	2.75
20	41.14	30.96	2.48	43.69	32.70	2.57	46.25	31.66	2.65	48.10	32.33	2.70	51.37	32.60	2.74	53.92	33.22	2.79
25	41.10	31.20	2.50	43.66	32.96	2.60	46.22	31.92	2.70	48.06	32.59	2.72	51.31	32.86	2.78	53.87	33.47	2.83
30	41.09	31.44	2.55	43.63	33.22	2.64	46.18	32.16	2.74	48.03	32.83	2.76	51.28	33.10	2.82	53.84	33.73	2.87
35	41.05	31.68	2.59	43.59	33.46	2.67	46.15	32.40	2.78	47.98	33.09	2.81	51.25	33.36	2.86	53.79	33.99	2.91
40	41.02	31.92	2.61	43.56	33.72	2.71	46.12	32.64	2.81	47.94	33.33	2.85	51.21	33.60	2.90	53.75	34.25	2.96
45	40.98	32.16	2.65	43.52	33.97	2.75	46.08	32.88	2.85	47.91	33.59	2.89	51.16	33.86	2.93	53.70	34.51	3.00
50	40.95	32.38	2.68	43.49	34.22	2.78	46.05	33.12	2.89	47.88	33.83	2.91	51.13	34.12	2.97	53.67	34.75	3.04
55	40.92	32.62	2.72	43.46	34.47	2.82	46.00	33.38	2.93	47.84	34.07	2.96	51.09	34.36	3.01	53.63	35.01	3.08
60	40.88	32.86	2.75	43.42	34.72	2.86	45.96	33.62	2.96	47.81	34.33	3.00	51.04	34.60	3.05	53.58	35.27	3.11
65	40.87	33.10	2.79	43.39	34.97	2.89	45.93	33.86	3.00	47.76	34.57	3.04	51.01	34.86	3.09	53.55	35.53	3.15
70	40.83	33.35	2.83	43.35	35.22	2.93	45.90	34.10	3.04	47.72	34.83	3.07	50.98	35.10	3.13	53.50	35.77	3.19
75	39.85	32.79	2.98	42.37	34.68	3.09	44.90	33.62	3.20	46.73	34.34	3.24	49.96	34.68	3.30	52.48	35.36	3.37
80	38.87	32.23	3.13	41.39	34.14	3.24	43.91	33.12	3.37	45.73	33.88	3.41	48.96	34.25	3.46	51.48	34.96	3.53
85	37.88	31.64	3.28	40.41	33.57	3.41	42.91	32.60	3.53	44.74	33.38	3.57	47.96	33.79	3.64	50.47	34.51	3.71
90	36.92	31.05	3.43	39.43	32.97	3.56	41.93	32.09	3.69	43.74	32.86	3.74	46.96	33.31	3.80	49.47	34.07	3.89
95	35.85	30.72	3.59	38.36	32.68	3.72	40.85	31.85	3.86	42.00	32.14	3.90	45.84	33.14	3.97	48.35	33.92	4.05
100	34.99	29.90	3.74	37.48	31.85	3.87	39.98	31.09	4.02	41.46	31.64	4.06	44.98	32.42	4.15	47.47	33.22	4.23
105	34.11	29.07	3.90	36.61	31.03	4.04	39.10	30.33	4.19	40.92	31.14	4.23	44.10	31.72	4.31	46.61	32.53	4.39
110	33.24	28.09	4.05	35.73	30.03	4.19	38.24	29.38	4.35	40.04	30.22	4.39	43.24	30.81	4.47	45.73	31.62	4.57
115	32.36	27.24	4.20	34.87	29.18	4.35	37.36	28.61	4.52	39.17	29.44	4.56	42.36	30.07	4.65	44.86	30.92	4.75
118	31.84	27.05	4.30	34.35	29.01	4.45	36.83	28.46	4.61	38.65	29.31	4.67	41.83	29.98	4.75	44.34	30.83	4.84
122	31.67	26.98	4.41	34.16	28.94	4.57	36.67	28.42	4.73	38.46	29.27	4.79	41.66	29.94	4.89	44.15	30.81	4.98

DB: Dry Bulb Temperature (°F) WB: Wet Bulb Temperature (°F) TC: Total Capacity (kBtu/h)
 SHC: Sensible Capacity (kBtu/h) PI: Power Input (kW) (includes compressor, indoor fan motor and outdoor fan motor)

- All capacities are net, evaporator fan motor heat is deducted.
- Cooling range can be extended from 5°F down to -4°F using the Low Ambient Wind Baffle Kit (sold separately).
- Grey shading indicates reference data. Operation outside of the verified temperature range is subject to decreased performance and / or safety interruption. .

4. Direct interpolation is permissible. ⊘ Do not extrapolate.

Capacity as rated: 0 ft. above sea level with 24.6 ft. of refrigerant piping, 0 ft. level difference between outdoor and indoor units.

Cooling capacity rating obtained with air entering the indoor unit at 80°F dry bulb (DB) and 67°F wet bulb (WB), and outdoor ambient conditions of 95°F dry bulb (DB) and 75°F wet bulb (WB).

MAXIMUM COOLING CAPACITY

KSSCB421A (KNSCB421A / KUSXB421A)

Table 31: KSSCB421A (KNSCB421A / KUSXB421A) Maximum Cooling Capacities.

Outdoor Air Temp. (°F DB)	Indoor Air Temperature (°F DB / °F WB)																	
	68 / 57			72 / 61			77 / 64			80 / 67			86 / 72			90 / 75		
	TC	SHC	PI	TC	SHC	PI	TC	SHC	PI	TC	SHC	PI	TC	SHC	PI	TC	SHC	PI
-4	47.88	36.14	3.26	50.86	38.16	3.38	53.83	36.95	3.49	55.97	37.74	3.53	59.78	38.05	3.61	62.74	38.77	3.67
-0.4	47.86	36.35	3.28	50.82	38.39	3.42	53.81	37.18	3.53	55.95	37.96	3.57	59.74	38.28	3.65	62.72	38.99	3.72
5	47.82	36.66	3.34	50.78	38.72	3.47	53.75	37.49	3.59	55.89	38.30	3.63	59.70	38.61	3.71	62.66	39.35	3.78
10	47.78	36.95	3.40	50.74	39.04	3.51	53.71	37.80	3.65	55.85	38.59	3.69	59.64	38.93	3.76	62.60	39.67	3.84
15	47.74	37.24	3.44	50.70	39.35	3.57	53.67	38.10	3.71	55.81	38.90	3.74	59.60	39.22	3.80	62.56	39.96	3.88
20	47.70	37.53	3.49	50.66	39.65	3.63	53.63	38.39	3.74	55.77	39.20	3.80	59.56	39.53	3.86	62.52	40.27	3.94
25	47.66	37.83	3.53	50.62	39.96	3.67	53.59	38.70	3.80	55.73	39.51	3.84	59.50	39.85	3.92	62.47	40.59	3.99
30	47.64	38.12	3.59	50.59	40.27	3.72	53.55	38.99	3.86	55.69	39.80	3.90	59.46	40.14	3.98	62.43	40.90	4.05
35	47.60	38.41	3.65	50.55	40.57	3.76	53.51	39.29	3.92	55.63	40.12	3.96	59.42	40.45	4.03	62.37	41.22	4.11
40	47.56	38.70	3.69	50.51	40.88	3.82	53.47	39.58	3.96	55.59	40.41	4.01	59.38	40.75	4.09	62.33	41.53	4.17
45	47.52	38.99	3.74	50.47	41.19	3.88	53.43	39.87	4.01	55.55	40.72	4.07	59.32	41.06	4.13	62.27	41.85	4.23
50	47.48	39.26	3.78	50.43	41.49	3.92	53.39	40.16	4.07	55.51	41.01	4.11	59.28	41.37	4.19	62.23	42.14	4.28
55	47.44	39.56	3.84	50.39	41.80	3.98	53.33	40.48	4.13	55.47	41.31	4.17	59.25	41.67	4.25	62.19	42.45	4.34
60	47.40	39.85	3.88	50.35	42.09	4.03	53.30	40.77	4.17	55.44	41.62	4.23	59.19	41.96	4.30	62.13	42.77	4.38
65	47.38	40.14	3.94	50.31	42.41	4.07	53.26	41.06	4.23	55.38	41.91	4.28	59.15	42.27	4.36	62.09	43.08	4.44
70	47.35	40.43	3.99	50.27	42.70	4.13	53.22	41.35	4.28	55.34	42.23	4.32	59.11	42.56	4.42	62.03	43.37	4.50
75	46.21	39.76	4.21	49.13	42.05	4.36	52.06	40.77	4.52	54.18	41.64	4.57	57.93	42.05	4.65	60.86	42.88	4.75
80	45.07	39.08	4.42	47.99	41.40	4.57	50.92	40.16	4.75	53.02	41.08	4.81	56.77	41.53	4.88	59.70	42.38	4.98
85	43.93	38.37	4.63	46.85	40.70	4.81	49.76	39.53	4.98	51.88	40.48	5.04	55.61	40.97	5.13	58.52	41.85	5.23
90	42.81	37.65	4.84	45.72	39.98	5.02	48.62	38.90	5.21	50.72	39.85	5.27	54.45	40.39	5.36	57.36	41.31	5.48
95	41.57	37.24	5.06	44.48	39.62	5.25	47.36	38.61	5.44	48.70	38.97	5.50	53.16	40.18	5.60	56.06	41.13	5.71
100	40.57	36.26	5.27	43.46	38.61	5.46	46.36	37.69	5.67	48.07	38.37	5.73	52.16	39.31	5.85	55.04	40.27	5.96
105	39.55	35.25	5.50	42.46	37.62	5.69	45.34	36.77	5.91	47.44	37.76	5.96	51.14	38.46	6.08	54.04	39.44	6.19
110	38.55	34.06	5.71	41.43	36.41	5.91	44.34	35.63	6.14	46.42	36.64	6.19	50.13	37.36	6.31	53.02	38.34	6.45
115	37.53	33.02	5.92	40.43	35.38	6.14	43.32	34.68	6.37	45.42	35.69	6.43	49.11	36.46	6.56	52.02	37.49	6.70
118	36.92	32.80	6.06	39.82	35.18	6.27	42.71	34.50	6.50	44.81	35.54	6.58	48.50	36.35	6.70	51.41	37.38	6.83
122	36.72	32.71	6.21	39.61	35.09	6.45	42.51	34.46	6.68	44.60	35.49	6.75	48.31	36.30	6.89	51.19	37.36	7.02

Performance Data

DB: Dry Bulb Temperature (°F) WB: Wet Bulb Temperature (°F) TC: Total Capacity (kBtu/h)

SHC: Sensible Capacity (kBtu/h) PI: Power Input (kW) (includes compressor, indoor fan motor and outdoor fan motor)

1. All capacities are net, evaporator fan motor heat is deducted.

2. Cooling range can be extended from 5°F down to -4°F using the Low Ambient Wind Baffle Kit (sold separately).

3. Grey shading indicates reference data. Operation outside of the verified temperature range is subject to decreased performance and / or safety interruption. .

4. Direct interpolation is permissible. ⊘ Do not extrapolate.

Capacity as rated: 0 ft. above sea level with 24.6 ft. of refrigerant piping, 0 ft. level difference between outdoor and indoor units.

Cooling capacity rating obtained with air entering the indoor unit at 80°F dry bulb (DB) and 67°F wet bulb (WB), and outdoor ambient conditions of 95°F dry bulb (DB) and 75°F wet bulb (WB).

MAXIMUM COOLING CAPACITY

KSSCB481A (KNSCB481A / KUSXB481A)

Table 32: KSSCB481A (KNSCB481A / KUSXB481A) Maximum Cooling Capacities.

Outdoor Air Temp. (°F DB)	Indoor Air Temperature (°F DB / °F WB)																	
	68 / 57			72 / 61			77 / 64			80 / 67			86 / 72			90 / 75		
	TC	SHC	PI	TC	SHC	PI	TC	SHC	PI	TC	SHC	PI	TC	SHC	PI	TC	SHC	PI
-4	52.10	37.06	3.51	55.35	39.13	3.64	58.58	37.89	3.76	60.91	38.69	3.80	65.05	39.02	3.88	68.28	39.75	3.95
-0.4	52.08	37.27	3.53	55.31	39.36	3.68	58.56	38.12	3.80	60.89	38.92	3.84	65.01	39.25	3.93	68.26	39.98	4.01
5	52.04	37.59	3.59	55.27	39.71	3.74	58.49	38.44	3.86	60.82	39.27	3.91	64.97	39.59	3.99	68.19	40.35	4.07
10	52.00	37.89	3.66	55.22	40.03	3.78	58.45	38.76	3.93	60.78	39.57	3.97	64.90	39.91	4.05	68.13	40.67	4.13
15	51.95	38.19	3.70	55.18	40.35	3.84	58.41	39.06	3.99	60.74	39.89	4.03	64.86	40.21	4.09	68.09	40.97	4.18
20	51.91	38.49	3.76	55.14	40.65	3.91	58.36	39.36	4.03	60.69	40.19	4.09	64.82	40.54	4.15	68.05	41.29	4.24
25	51.87	38.79	3.80	55.09	40.97	3.95	58.32	39.68	4.09	60.65	40.51	4.13	64.75	40.86	4.22	67.98	41.62	4.30
30	51.85	39.09	3.86	55.05	41.29	4.01	58.28	39.98	4.15	60.61	40.81	4.20	64.71	41.16	4.28	67.94	41.94	4.36
35	51.80	39.38	3.93	55.01	41.59	4.05	58.24	40.28	4.22	60.54	41.13	4.26	64.67	41.48	4.34	67.87	42.26	4.42
40	51.76	39.68	3.97	54.97	41.92	4.11	58.19	40.58	4.26	60.50	41.43	4.32	64.63	41.78	4.40	67.83	42.58	4.49
45	51.72	39.98	4.03	54.92	42.24	4.18	58.15	40.88	4.32	60.46	41.76	4.38	64.56	42.10	4.45	67.77	42.91	4.55
50	51.68	40.26	4.07	54.88	42.54	4.22	58.11	41.18	4.38	60.42	42.05	4.42	64.52	42.42	4.51	67.72	43.21	4.61
55	51.63	40.56	4.13	54.84	42.86	4.28	58.04	41.50	4.45	60.37	42.35	4.49	64.48	42.72	4.57	67.68	43.53	4.67
60	51.59	40.86	4.18	54.80	43.16	4.34	58.00	41.80	4.49	60.33	42.68	4.55	64.41	43.02	4.63	67.62	43.85	4.72
65	51.57	41.16	4.24	54.75	43.48	4.38	57.96	42.10	4.55	60.27	42.98	4.61	64.37	43.34	4.69	67.58	44.17	4.78
70	51.53	41.46	4.30	54.71	43.78	4.45	57.92	42.40	4.61	60.22	43.30	4.65	64.33	43.64	4.76	67.51	44.47	4.84
75	50.29	40.77	4.53	53.47	43.11	4.69	56.65	41.80	4.86	58.96	42.70	4.92	63.04	43.11	5.01	66.23	43.96	5.11
80	49.05	40.07	4.76	52.23	42.45	4.92	55.41	41.18	5.11	57.70	42.12	5.17	61.78	42.58	5.26	64.97	43.46	5.36
85	47.81	39.34	4.99	50.99	41.73	5.17	54.15	40.54	5.36	56.46	41.50	5.42	60.52	42.01	5.53	63.69	42.91	5.63
90	46.59	38.60	5.21	49.75	41.00	5.40	52.91	39.89	5.61	55.20	40.86	5.67	59.26	41.41	5.77	62.42	42.35	5.90
95	45.24	38.19	5.44	48.41	40.63	5.65	51.55	39.59	5.86	53.00	39.96	5.92	57.85	41.20	6.02	61.01	42.17	6.15
100	44.15	37.17	5.67	47.29	39.59	5.88	50.46	38.65	6.11	52.32	39.34	6.17	56.76	40.31	6.29	59.90	41.29	6.42
105	43.04	36.14	5.92	46.20	38.58	6.13	49.35	37.70	6.36	51.63	38.72	6.42	55.65	39.43	6.54	58.81	40.44	6.67
110	41.95	34.92	6.15	45.09	37.34	6.36	48.26	36.53	6.61	50.52	37.57	6.67	54.56	38.30	6.79	57.70	39.32	6.94
115	40.84	33.86	6.38	44.00	36.28	6.61	47.14	35.56	6.85	49.43	36.60	6.92	53.45	37.38	7.06	56.61	38.44	7.21
118	40.18	33.63	6.52	43.34	36.07	6.75	46.48	35.38	7.00	48.77	36.44	7.08	52.79	37.27	7.21	55.95	38.33	7.35
122	39.96	33.54	6.69	43.11	35.98	6.94	46.27	35.33	7.19	48.53	36.39	7.27	52.57	37.22	7.42	55.71	38.30	7.56

DB: Dry Bulb Temperature (°F) WB: Wet Bulb Temperature (°F) TC: Total Capacity (kBtu/h)
 SHC: Sensible Capacity (kBtu/h) PI: Power Input (kW) (includes compressor, indoor fan motor and outdoor fan motor)

- All capacities are net, evaporator fan motor heat is deducted.
- Cooling range can be extended from 5°F down to -4°F using the Low Ambient Wind Baffle Kit (sold separately).
- Grey shading indicates reference data. Operation outside of the verified temperature range is subject to decreased performance and / or safety interruption.

4. Direct interpolation is permissible. ⚠ Do not extrapolate.

Capacity as rated: 0 ft. above sea level with 24.6 ft. of refrigerant piping, 0 ft. level difference between outdoor and indoor units.

Cooling capacity rating obtained with air entering the indoor unit at 80°F dry bulb (DB) and 67°F wet bulb (WB), and outdoor ambient conditions of 95°F dry bulb (DB) and 75°F wet bulb (WB).

HEATING CAPACITY

KSUDB091A (KNUDB091A / KUSXB091A)

Table 33: KSUDB091A (KNUDB091A / KUSXB091A) Heating Capacities.

Outdoor Air Temp.		Indoor Air Temperature (°F DB)											
°F DB	°F WB	61		64		68		70		72		75	
		TC	PI	TC	PI	TC	PI	TC	PI	TC	PI	TC	PI
-4	-4.4	4.8	0.53	4.5	0.55	4.4	0.56	4.4	0.57	4.3	0.58	4.1	0.60
0	-0.4	5.4	0.55	5.1	0.56	5.0	0.58	4.9	0.59	4.8	0.60	4.6	0.61
5	4.5	6.0	0.57	5.8	0.58	5.6	0.60	5.5	0.61	5.4	0.62	5.2	0.63
10	9	6.5	0.58	6.2	0.60	6.0	0.62	5.9	0.63	5.9	0.64	5.6	0.66
17	15	7.0	0.61	6.7	0.63	6.5	0.65	6.4	0.66	6.3	0.66	6.1	0.68
20	19	7.5	0.62	7.2	0.64	7.0	0.66	6.9	0.67	6.8	0.68	6.5	0.70
25	23	8.3	0.65	8.0	0.66	7.8	0.69	7.6	0.70	7.5	0.71	7.2	0.73
30	28	9.1	0.67	8.8	0.69	8.5	0.71	8.4	0.72	8.3	0.73	8.0	0.75
35	32	9.9	0.69	9.6	0.71	9.3	0.74	9.2	0.75	9.0	0.76	8.7	0.78
40	36	10.7	0.71	10.4	0.74	10.1	0.76	9.9	0.77	9.8	0.78	9.4	0.81
45	41	11.5	0.74	11.2	0.76	10.9	0.79	10.7	0.80	10.5	0.81	10.2	0.84
47	43	11.8	0.75	11.5	0.77	11.2	0.80	11.00	0.81	10.9	0.82	10.5	0.85
50	46	11.8	0.74	11.6	0.77	11.3	0.79	11.1	0.80	11.0	0.81	10.6	0.83
55	51	11.9	0.73	11.7	0.75	11.5	0.77	11.3	0.78	11.2	0.79	10.9	0.80
60	56	11.9	0.72	11.8	0.74	11.6	0.76	11.5	0.76	11.4	0.77	11.2	0.77
63	59	12.0	0.72	11.8	0.73	11.7	0.74	11.6	0.75	11.6	0.75	11.3	0.76
68	64	12.0	0.72	11.9	0.72	11.8	0.73	11.8	0.74	11.7	0.74	11.5	0.74

DB: Dry Bulb Temperature (°F) WB: Wet Bulb Temperature (°F) TC: Total Capacity (kBtu/h)
 PI: Power Input (kW) (includes compressor, indoor fan motor and outdoor fan motor)

1. All capacities are net, evaporator fan motor heat is deducted.
2. Direct interpolation is permissible. ⊙ Do not extrapolate.

Capacity as rated: 0 ft. above sea level with 24.6 ft. of refrigerant piping. 0 ft. level difference between outdoor and indoor units.

Heating capacity rating obtained with air entering the indoor unit at 70°F dry bulb (DB) and 60°F wet bulb (WB), and outdoor ambient conditions of 47°F dry bulb (DB) and 43°F wet bulb (WB).

HEATING CAPACITY

KSUDB121A (KNUDB121A / KUSXB121A)

Table 34: KSUDB121A (KNUDB121A / KUSXB121A) Heating Capacities.

Outdoor Air Temp.		Indoor Air Temperature (°F DB)											
°F DB	°F WB	61		64		68		70		72		75	
		TC	PI	TC	PI	TC	PI	TC	PI	TC	PI	TC	PI
-4	-4.4	6.5	0.76	6.1	0.79	6.0	0.81	5.9	0.83	5.9	0.83	5.6	0.86
0	-0.4	7.3	0.79	6.9	0.81	6.8	0.83	6.7	0.85	6.6	0.86	6.3	0.88
5	4.5	8.2	0.81	7.8	0.84	7.6	0.86	7.5	0.88	7.4	0.89	7.1	0.91
10	9	8.8	0.84	8.5	0.86	8.2	0.89	8.1	0.91	8.0	0.92	7.6	0.94
17	15	9.5	0.88	9.2	0.90	8.9	0.93	8.7	0.94	8.6	0.96	8.2	0.98
20	19	10.0	0.90	9.7	0.93	9.4	0.96	9.2	0.97	9.1	0.98	8.7	1.01
25	23	10.9	0.94	10.6	0.97	10.3	1.00	10.1	1.02	10.0	1.03	9.6	1.06
30	28	11.9	0.98	11.5	1.01	11.2	1.04	11.0	1.06	10.8	1.07	10.4	1.10
35	32	12.8	1.02	12.5	1.05	12.1	1.09	11.9	1.10	11.7	1.12	11.3	1.15
40	36	13.7	1.06	13.4	1.09	13.0	1.13	12.8	1.15	12.6	1.16	12.1	1.20
45	41	14.6	1.10	14.3	1.13	13.9	1.17	13.6	1.19	13.5	1.21	13.0	1.24
47	43	15.0	1.12	14.7	1.15	14.2	1.19	14.00	1.21	13.8	1.22	13.3	1.26
50	46	15.0	1.11	14.7	1.14	14.4	1.18	14.2	1.19	14.0	1.21	13.5	1.24
55	51	15.1	1.10	14.9	1.12	14.6	1.15	14.4	1.16	14.3	1.18	13.9	1.20
60	56	15.2	1.08	15.0	1.11	14.8	1.13	14.7	1.14	14.6	1.14	14.2	1.16
63	59	15.2	1.08	15.1	1.10	14.9	1.11	14.8	1.12	14.7	1.12	14.4	1.14
68	64	15.3	1.07	15.1	1.08	15.1	1.10	15.0	1.10	14.9	1.10	14.6	1.11

DB: Dry Bulb Temperature (°F) WB: Wet Bulb Temperature (°F) TC: Total Capacity (kBtu/h)

PI: Power Input (kW) (includes compressor, indoor fan motor and outdoor fan motor)

1. All capacities are net, evaporator fan motor heat is deducted.

2. Direct interpolation is permissible. ⊙ Do not extrapolate.

Capacity as rated: 0 ft. above sea level with 24.6 ft. of refrigerant piping. 0 ft. level difference between outdoor and indoor units.

Heating capacity rating obtained with air entering the indoor unit at 70°F dry bulb (DB) and 60°F wet bulb (WB), and outdoor ambient conditions of 47°F dry bulb (DB) and 43°F wet bulb (WB).

HEATING CAPACITY

KSUDB181A (KNUDB181A / KUSXB181A)

Table 35: KSUDB181A (KNUDB181A / KUSXB181A) Heating Capacities.

Outdoor Air Temp.		Indoor Air Temperature (°F DB)											
°F DB	°F WB	61		64		68		70		72		75	
		TC	PI	TC	PI	TC	PI	TC	PI	TC	PI	TC	PI
-4	-4.4	9.7	1.19	9.1	1.22	9.0	1.25	8.9	1.28	8.8	1.29	8.4	1.33
0	-0.4	10.9	1.22	10.3	1.25	10.1	1.29	10.0	1.32	9.8	1.33	9.4	1.37
5	4.5	12.3	1.26	11.7	1.30	11.4	1.34	11.2	1.37	11.1	1.38	10.6	1.42
10	9	13.2	1.30	12.6	1.34	12.3	1.39	12.1	1.41	11.9	1.43	11.4	1.47
17	15	14.2	1.36	13.7	1.40	13.2	1.45	13.0	1.465	12.8	1.48	12.3	1.52
20	19	14.9	1.39	14.4	1.43	14.0	1.48	13.7	1.50	13.5	1.52	13.0	1.56
25	23	16.1	1.43	15.6	1.47	15.1	1.53	14.9	1.55	14.7	1.57	14.1	1.61
30	28	17.3	1.48	16.8	1.52	16.3	1.58	16.0	1.60	15.8	1.62	15.2	1.67
35	32	18.5	1.53	18.0	1.57	17.5	1.63	17.2	1.65	17.0	1.67	16.3	1.72
40	36	19.7	1.57	19.2	1.62	18.7	1.68	18.4	1.70	18.1	1.72	17.5	1.78
45	41	20.9	1.62	20.5	1.67	19.9	1.73	19.5	1.76	19.3	1.77	18.6	1.83
47	43	21.4	1.64	20.9	1.69	20.3	1.75	20.00	1.776	19.7	1.80	19.0	1.85
50	46	21.5	1.63	21.0	1.68	20.5	1.73	20.2	1.75	20.0	1.78	19.3	1.82
55	51	21.6	1.61	21.2	1.65	20.8	1.69	20.6	1.71	20.4	1.73	19.8	1.76
60	56	21.7	1.59	21.4	1.63	21.1	1.66	21.0	1.67	20.8	1.68	20.3	1.70
63	59	21.7	1.58	21.5	1.61	21.3	1.63	21.2	1.64	21.1	1.65	20.6	1.67
68	64	21.8	1.57	21.6	1.59	21.5	1.61	21.4	1.62	21.3	1.62	20.9	1.63

DB: Dry Bulb Temperature (°F) WB: Wet Bulb Temperature (°F) TC: Total Capacity (kBtu/h)
 PI: Power Input (kW) (includes compressor, indoor fan motor and outdoor fan motor)
 1. All capacities are net, evaporator fan motor heat is deducted.
 2. Direct interpolation is permissible. ☉ Do not extrapolate.

Capacity as rated: 0 ft. above sea level with 24.6 ft. of refrigerant piping. 0 ft. level difference between outdoor and indoor units.
 Heating capacity rating obtained with air entering the indoor unit at 70°F dry bulb (DB) and 60°F wet bulb (WB), and outdoor ambient conditions of 47°F dry bulb (DB) and 43°F wet bulb (WB).

Performance Data

HEATING CAPACITY

KSSCB241A (KNSCB241A / KUSXB241A)

Table 36: KSSCB241A (KNSCB241A / KUSXB241A) Heating Capacities.

Outdoor Air Temp.		Indoor Air Temperature (°F DB)											
°F DB	°F WB	61		64		68		70		72		75	
		TC	PI	TC	PI	TC	PI	TC	PI	TC	PI	TC	PI
-4	-4.4	11.0	1.38	10.2	1.42	10.2	1.46	10.1	1.49	10.0	1.51	9.5	1.55
0	-0.4	13.0	1.42	12.2	1.46	12.0	1.51	11.9	1.54	11.7	1.55	11.2	1.60
5	4.5	15.3	1.47	14.6	1.52	14.2	1.56	14.0	1.59	13.8	1.61	13.3	1.65
10	9	16.8	1.52	16.1	1.56	15.7	1.62	15.4	1.64	15.2	1.66	14.6	1.71
17	15	18.5	1.58	17.9	1.63	17.3	1.68	17.0	1.718	16.8	1.72	16.1	1.78
20	19	19.6	1.62	18.9	1.67	18.3	1.73	18.0	1.76	17.7	1.77	17.1	1.83
25	23	21.3	1.70	20.7	1.75	20.0	1.81	19.7	1.84	19.4	1.86	18.7	1.92
30	28	23.0	1.77	22.4	1.83	21.7	1.89	21.3	1.92	21.0	1.94	20.3	2.00
35	32	24.8	1.85	24.1	1.91	23.4	1.97	23.0	2.00	22.7	2.03	21.8	2.09
40	36	26.5	1.92	25.8	1.98	25.1	2.05	24.7	2.08	24.3	2.11	23.4	2.18
45	41	28.2	1.99	27.6	2.06	26.8	2.13	26.3	2.17	26.0	2.20	25.0	2.26
47	43	28.9	2.02	28.3	2.09	27.5	2.16	27.00	2.20	26.6	2.23	25.7	2.30
50	46	29.0	2.01	28.4	2.07	27.7	2.13	27.3	2.17	27.0	2.19	26.1	2.25
55	51	29.1	1.99	28.7	2.04	28.1	2.09	27.8	2.11	27.5	2.13	26.7	2.18
60	56	29.3	1.98	28.9	2.01	28.5	2.04	28.3	2.06	28.1	2.07	27.4	2.11
63	59	29.4	1.97	29.0	1.99	28.8	2.02	28.6	2.03	28.4	2.04	27.8	2.06
68	64	29.4	1.95	29.2	1.98	29.0	1.99	28.9	2.00	28.8	2.00	28.2	2.02

DB: Dry Bulb Temperature (°F) WB: Wet Bulb Temperature (°F) TC: Total Capacity (kBtu/h)

PI: Power Input (kW) (includes compressor, indoor fan motor and outdoor fan motor)

1. All capacities are net, evaporator fan motor heat is deducted.

2. Direct interpolation is permissible. ⊙ Do not extrapolate.

Capacity as rated: 0 ft. above sea level with 24.6 ft. of refrigerant piping. 0 ft. level difference between outdoor and indoor units.

Heating capacity rating obtained with air entering the indoor unit at 70°F dry bulb (DB) and 60°F wet bulb (WB), and outdoor ambient conditions of 47°F dry bulb (DB) and 43°F wet bulb (WB).

HEATING CAPACITY

KSSCB301A (KNSCB301A / KUSXB301A)

Table 37: KSSCB301A (KNSCB301A / KUSXB301A) Heating Capacities.

Outdoor Air Temp.		Indoor Air Temperature (°F DB)											
°F DB	°F WB	61		64		68		70		72		75	
		TC	PI	TC	PI	TC	PI	TC	PI	TC	PI	TC	PI
-4	-4.4	13.6	1.62	12.7	1.66	12.6	1.72	12.4	1.75	12.3	1.77	11.8	1.82
0	-0.4	16.0	1.66	15.1	1.72	14.9	1.77	14.6	1.80	14.5	1.82	13.9	1.87
5	4.5	18.9	1.73	18.0	1.78	17.6	1.83	17.3	1.86	17.1	1.88	16.4	1.94
10	9	20.8	1.78	19.9	1.83	19.4	1.89	19.1	1.93	18.8	1.95	18.0	2.00
17	15	22.9	1.85	22.1	1.91	21.4	1.97	21.0	2.00	20.7	2.02	19.9	2.08
20	19	24.1	1.90	23.3	1.96	22.6	2.02	22.2	2.05	21.9	2.08	21.0	2.14
25	23	26.2	1.98	25.4	2.04	24.6	2.11	24.2	2.15	23.9	2.17	23.0	2.24
30	28	28.3	2.06	27.5	2.13	26.7	2.20	26.2	2.24	25.8	2.26	24.9	2.33
35	32	30.4	2.15	29.6	2.21	28.7	2.29	28.2	2.33	27.8	2.36	26.8	2.43
40	36	32.4	2.23	31.6	2.30	30.7	2.38	30.2	2.42	29.8	2.45	28.7	2.52
45	41	34.5	2.31	33.7	2.39	32.7	2.46	32.2	2.51	31.8	2.54	30.6	2.62
47	43	35.3	2.34	34.5	2.42	33.6	2.50	33.00	2.545	32.6	2.58	31.4	2.66
50	46	35.4	2.33	34.7	2.40	33.9	2.47	33.4	2.51	33.0	2.53	31.9	2.60
55	51	35.6	2.31	35.0	2.36	34.4	2.42	34.0	2.44	33.7	2.47	32.7	2.52
60	56	35.8	2.28	35.3	2.33	34.9	2.36	34.6	2.39	34.3	2.40	33.5	2.44
63	59	35.9	2.27	35.5	2.31	35.2	2.34	34.9	2.35	34.8	2.36	33.9	2.39
68	64	36.0	2.25	35.7	2.28	35.5	2.31	35.3	2.32	35.2	2.32	34.4	2.34

DB: Dry Bulb Temperature (°F) WB: Wet Bulb Temperature (°F) TC: Total Capacity (kBtu/h)
 PI: Power Input (kW) (includes compressor, indoor fan motor and outdoor fan motor)

1. All capacities are net, evaporator fan motor heat is deducted.
2. Direct interpolation is permissible. ⊙ Do not extrapolate.

Capacity as rated: 0 ft. above sea level with 24.6 ft. of refrigerant piping. 0 ft. level difference between outdoor and indoor units.

Heating capacity rating obtained with air entering the indoor unit at 70°F dry bulb (DB) and 60°F wet bulb (WB), and outdoor ambient conditions of 47°F dry bulb (DB) and 43°F wet bulb (WB).

HEATING CAPACITY

KSSCB361A (KNSCB361A / KUSXB361A)

Table 38: KSSCB361A (KNSCB361A / KUSXB361A) Heating Capacities.

Outdoor Air Temp.		Indoor Air Temperature (°F DB)											
°F DB	°F WB	61		64		68		70		72		75	
		TC	PI	TC	PI	TC	PI	TC	PI	TC	PI	TC	PI
-4	-4.4	18.6	1.96	17.3	2.02	17.2	2.07	16.9	2.12	16.8	2.14	16.0	2.20
0	-0.4	20.8	2.02	19.6	2.07	19.2	2.14	19.0	2.18	18.7	2.20	18.0	2.26
5	4.5	23.4	2.09	22.3	2.15	21.8	2.22	21.4	2.26	21.1	2.28	20.3	2.34
10	9	25.1	2.15	24.1	2.22	23.4	2.30	23.0	2.33	22.7	2.36	21.8	2.42
17	15	27.0	2.25	26.1	2.31	25.3	2.39	24.8	2.42	24.4	2.45	23.5	2.52
20	19	28.6	2.28	27.7	2.34	26.8	2.42	26.3	2.46	25.9	2.49	24.9	2.55
25	23	31.2	2.32	30.3	2.39	29.4	2.47	28.9	2.51	28.4	2.54	27.4	2.61
30	28	33.9	2.37	32.9	2.44	31.9	2.53	31.4	2.56	30.9	2.60	29.8	2.67
35	32	36.5	2.42	35.6	2.49	34.5	2.58	33.9	2.62	33.5	2.65	32.2	2.73
40	36	39.1	2.47	38.2	2.54	37.1	2.63	36.5	2.67	36.0	2.70	34.6	2.79
45	41	41.8	2.52	40.8	2.59	39.6	2.68	39.0	2.73	38.5	2.76	37.1	2.85
47	43	42.8	2.54	41.9	2.61	40.7	2.70	40.00	2.75	39.5	2.78	38.0	2.87
50	46	42.9	2.52	42.1	2.60	41.0	2.67	40.4	2.70	40.0	2.75	38.6	2.81
55	51	43.2	2.49	42.4	2.55	41.7	2.61	41.2	2.64	40.8	2.67	39.6	2.72
60	56	43.4	2.46	42.8	2.52	42.3	2.57	41.9	2.58	41.6	2.60	40.6	2.63
63	59	43.5	2.44	43.0	2.49	42.6	2.52	42.4	2.54	42.1	2.55	41.1	2.58
68	64	43.6	2.43	43.2	2.46	43.0	2.49	42.8	2.51	42.6	2.51	41.7	2.52

DB: Dry Bulb Temperature (°F) WB: Wet Bulb Temperature (°F) TC: Total Capacity (kBtu/h)
 PI: Power Input (kW) (includes compressor, indoor fan motor and outdoor fan motor)

1. All capacities are net, evaporator fan motor heat is deducted.
2. Direct interpolation is permissible. ⚠ Do not extrapolate.

Capacity as rated: 0 ft. above sea level with 24.6 ft. of refrigerant piping. 0 ft. level difference between outdoor and indoor units.

Heating capacity rating obtained with air entering the indoor unit at 70°F dry bulb (DB) and 60°F wet bulb (WB), and outdoor ambient conditions of 47°F dry bulb (DB) and 43°F wet bulb (WB).

HEATING CAPACITY

KSSCB421A (KNSCB421A / KUSXB421A)

Table 39: KSSCB421A (KNSCB421A / KUSXB421A) Heating Capacities.

Outdoor Air Temp.		Indoor Air Temperature (°F DB)											
°F DB	°F WB	61		64		68		70		72		75	
		TC	PI	TC	PI	TC	PI	TC	PI	TC	PI	TC	PI
-4	-4.4	22.5	2.30	21.0	2.37	20.8	2.43	20.5	2.48	20.3	2.50	19.4	2.58
0	-0.4	25.1	2.37	23.7	2.43	23.3	2.50	23.0	2.56	22.7	2.58	21.7	2.65
5	4.5	28.3	2.44	27.0	2.52	26.3	2.59	25.9	2.65	25.5	2.67	24.5	2.74
10	9	30.4	2.52	29.1	2.59	28.3	2.69	27.8	2.72	27.5	2.76	26.4	2.84
17	15	32.7	2.63	31.6	2.71	30.5	2.80	30.0	2.84	29.6	2.87	28.4	2.95
20	19	34.5	2.68	33.4	2.75	32.4	2.85	31.8	2.89	31.3	2.92	30.1	3.00
25	23	37.7	2.75	36.5	2.83	35.4	2.93	34.8	2.97	34.3	3.01	33.0	3.10
30	28	40.8	2.83	39.7	2.91	38.5	3.01	37.8	3.06	37.3	3.10	35.9	3.19
35	32	43.9	2.91	42.8	2.99	41.5	3.10	40.8	3.14	40.2	3.18	38.8	3.28
40	36	47.0	2.98	45.9	3.07	44.5	3.18	43.8	3.23	43.2	3.27	41.6	3.37
45	41	50.1	3.06	49.0	3.15	47.6	3.26	46.8	3.32	46.2	3.35	44.5	3.46
47	43	51.4	3.09	50.2	3.18	48.8	3.29	48.00	3.35	47.4	3.39	45.6	3.50
50	46	51.5	3.07	50.5	3.16	49.2	3.26	48.5	3.29	48.0	3.35	46.3	3.42
55	51	51.8	3.03	50.9	3.11	50.0	3.18	49.4	3.22	49.0	3.26	47.5	3.31
60	56	52.0	3.00	51.4	3.07	50.7	3.13	50.3	3.15	49.9	3.16	48.7	3.20
63	59	52.2	2.98	51.6	3.03	51.2	3.07	50.8	3.09	50.5	3.11	49.4	3.15
68	64	52.3	2.96	51.9	3.00	51.6	3.03	51.4	3.05	51.1	3.05	50.1	3.07

DB: Dry Bulb Temperature (°F) WB: Wet Bulb Temperature (°F) TC: Total Capacity (kBtu/h)
 PI: Power Input (kW) (includes compressor, indoor fan motor and outdoor fan motor)
 1. All capacities are net, evaporator fan motor heat is deducted.
 2. Direct interpolation is permissible. ⊙ Do not extrapolate.

Capacity as rated: 0 ft. above sea level with 24.6 ft. of refrigerant piping. 0 ft. level difference between outdoor and indoor units.
 Heating capacity rating obtained with air entering the indoor unit at 70°F dry bulb (DB) and 60°F wet bulb (WB), and outdoor ambient conditions of 47°F dry bulb (DB) and 43°F wet bulb (WB).

Performance Data

HEATING CAPACITY

KSSCB481A (KNSCB481A / KUSXB481A)

Table 40: KSSCB481A (KNSCB481A / KUSXB481A) Heating Capacities.

Outdoor Air Temp.		Indoor Air Temperature (°F DB)											
°F DB	°F WB	61		64		68		70		72		75	
		TC	PI	TC	PI	TC	PI	TC	PI	TC	PI	TC	PI
-4	-4.4	24.1	2.50	22.5	2.58	22.3	2.64	22.0	2.70	21.8	2.72	20.8	2.80
0	-0.4	27.0	2.58	25.4	2.64	25.0	2.72	24.6	2.78	24.3	2.80	23.3	2.88
5	4.5	30.3	2.66	28.9	2.74	28.2	2.82	27.8	2.88	27.4	2.90	26.3	2.98
10	9	32.6	2.74	31.3	2.82	30.4	2.92	29.9	2.96	29.5	3.00	28.3	3.08
17	15	35.1	2.86	33.9	2.94	32.8	3.04	32.2	3.08	31.7	3.12	30.5	3.21
20	19	37.0	2.92	35.8	3.01	34.7	3.11	34.1	3.15	33.6	3.19	32.3	3.28
25	23	40.3	3.03	39.1	3.11	37.9	3.22	37.2	3.27	36.7	3.31	35.3	3.40
30	28	43.5	3.13	42.3	3.22	41.0	3.33	40.3	3.38	39.8	3.42	38.3	3.52
35	32	46.8	3.23	45.6	3.33	44.2	3.44	43.5	3.50	42.9	3.54	41.3	3.64
40	36	50.0	3.33	48.8	3.43	47.4	3.55	46.6	3.61	46.0	3.65	44.3	3.77
45	41	53.3	3.44	52.1	3.54	50.6	3.66	49.7	3.72	49.1	3.77	47.3	3.89
47	43	54.6	3.48	53.4	3.58	51.8	3.71	51.00	3.77	50.3	3.81	48.5	3.94
50	46	54.7	3.46	53.7	3.56	52.3	3.67	51.6	3.71	50.9	3.77	49.2	3.85
55	51	55.0	3.41	54.1	3.50	53.1	3.58	52.5	3.62	52.0	3.67	50.5	3.73
60	56	55.3	3.37	54.6	3.46	53.9	3.52	53.4	3.54	53.1	3.56	51.7	3.60
63	59	55.4	3.35	54.9	3.41	54.4	3.46	54.0	3.48	53.7	3.50	52.5	3.54
68	64	55.6	3.33	55.1	3.37	54.9	3.41	54.6	3.43	54.3	3.43	53.2	3.46

DB: Dry Bulb Temperature (°F) WB: Wet Bulb Temperature (°F) TC: Total Capacity (kBtu/h)
 PI: Power Input (kW) (includes compressor, indoor fan motor and outdoor fan motor)

1. All capacities are net, evaporator fan motor heat is deducted.
2. Direct interpolation is permissible. ⊘ Do not extrapolate.

Capacity as rated: 0 ft. above sea level with 24.6 ft. of refrigerant piping. 0 ft. level difference between outdoor and indoor units.

Heating capacity rating obtained with air entering the indoor unit at 70°F dry bulb (DB) and 60°F wet bulb (WB), and outdoor ambient conditions of 47°F dry bulb (DB) and 43°F wet bulb (WB).

MAXIMUM HEATING CAPACITY

KSUDB091A (KNUDB091A / KUSXB091A)

Table 41: KSUDB091A (KNUDB091A / KUSXB091A) Maximum Heating Capacities.

Outdoor Air Temp.		Indoor Air Temperature (°F DB)											
°F DB	°F WB	61		64		68		70		72		75	
		TC	PI	TC	PI	TC	PI	TC	PI	TC	PI	TC	PI
-4	-4.4	10.0	1.24	9.7	1.29	9.5	1.33	9.3	1.35	9.2	1.37	8.8	1.41
0	-0.4	10.5	1.29	10.2	1.33	10.0	1.37	9.8	1.39	9.7	1.41	9.3	1.46
5	4.5	11.1	1.34	10.9	1.38	10.6	1.42	10.4	1.45	10.3	1.47	9.9	1.52
10	9	11.7	1.30	11.4	1.34	11.1	1.39	10.9	1.41	10.8	1.43	10.4	1.48
17	15	12.4	1.26	12.1	1.30	11.8	1.34	11.6	1.360	11.4	1.38	11.0	1.42
20	19	12.8	1.25	12.5	1.29	12.1	1.34	11.9	1.36	11.8	1.38	11.4	1.42
25	23	13.4	1.25	13.1	1.29	12.7	1.33	12.5	1.36	12.3	1.38	11.9	1.42
30	28	14.0	1.25	13.7	1.29	13.3	1.33	13.1	1.36	12.9	1.38	12.4	1.41
35	32	14.6	1.25	14.3	1.29	13.9	1.33	13.6	1.35	13.5	1.37	13.0	1.41
40	36	15.2	1.25	14.9	1.29	14.4	1.33	14.2	1.35	14.0	1.37	13.5	1.41
45	41	15.8	1.25	15.5	1.29	15.0	1.33	14.8	1.35	14.6	1.37	14.0	1.41
47	43	16.1	1.25	15.7	1.29	15.2	1.33	15.00	1.350	14.8	1.37	14.3	1.41
50	46	16.1	1.24	15.8	1.27	15.4	1.31	15.2	1.33	15.0	1.34	14.5	1.38
55	51	16.2	1.23	15.9	1.26	15.6	1.28	15.4	1.30	15.3	1.31	14.8	1.34
60	56	16.3	1.21	16.1	1.24	15.9	1.26	15.7	1.27	15.6	1.27	15.2	1.29
63	59	16.3	1.20	16.1	1.22	16.0	1.24	15.9	1.25	15.8	1.25	15.4	1.27
68	64	16.4	1.19	16.2	1.21	16.1	1.23	16.1	1.23	16.0	1.23	15.6	1.24

DB: Dry Bulb Temperature (°F) WB: Wet Bulb Temperature (°F) TC: Total Capacity (kBtu/h)
 PI: Power Input (kW) (includes compressor, indoor fan motor and outdoor fan motor)

1. All capacities are net, evaporator fan motor heat is deducted.
2. Direct interpolation is permissible. ⚠ Do not extrapolate.

Capacity as rated: 0 ft. above sea level with 24.6 ft. of refrigerant piping. 0 ft. level difference between outdoor and indoor units.

Heating capacity rating obtained with air entering the indoor unit at 70°F dry bulb (DB) and 60°F wet bulb (WB), and outdoor ambient conditions of 47°F dry bulb (DB) and 43°F wet bulb (WB).

Performance Data

MAXIMUM HEATING CAPACITY

KSUDB121A (KNUDB121A / KUSXB121A)

Table 42: KSUDB121A (KNUDB121A / KUSXB121A) Maximum Heating Capacities.

Outdoor Air Temp.		Indoor Air Temperature (°F DB)											
°F DB	°F WB	61		64		68		70		72		75	
		TC	PI	TC	PI	TC	PI	TC	PI	TC	PI	TC	PI
-4	-4.4	10.5	1.27	10.3	1.32	10.0	1.36	9.8	1.38	9.7	1.40	9.3	1.44
0	-0.4	10.9	1.30	10.7	1.34	10.4	1.39	10.2	1.41	10.1	1.43	9.7	1.47
5	4.5	11.5	1.34	11.2	1.38	10.9	1.42	10.7	1.45	10.6	1.47	10.2	1.52
10	9	12.3	1.39	12.1	1.43	11.7	1.48	11.5	1.50	11.4	1.53	11.0	1.57
17	15	13.6	1.46	13.3	1.51	12.9	1.55	12.7	1.58	12.5	1.60	12.1	1.65
20	19	14.0	1.46	13.7	1.51	13.3	1.56	13.1	1.58	12.9	1.61	12.4	1.65
25	23	14.7	1.47	14.4	1.52	13.9	1.56	13.7	1.59	13.5	1.61	13.0	1.66
30	28	15.4	1.47	15.0	1.52	14.6	1.57	14.3	1.60	14.2	1.62	13.6	1.67
35	32	16.0	1.48	15.7	1.53	15.2	1.58	15.0	1.60	14.8	1.63	14.2	1.67
40	36	16.7	1.49	16.3	1.54	15.9	1.59	15.6	1.61	15.4	1.64	14.8	1.68
45	41	17.4	1.49	17.0	1.54	16.5	1.59	16.2	1.62	16.0	1.64	15.4	1.69
47	43	17.7	1.50	17.3	1.55	16.8	1.60	16.50	1.620	16.3	1.64	15.7	1.69
50	46	17.7	1.48	17.4	1.53	16.9	1.57	16.7	1.60	16.5	1.61	15.9	1.66
55	51	17.8	1.47	17.5	1.51	17.2	1.54	17.0	1.56	16.8	1.57	16.3	1.61
60	56	17.9	1.45	17.7	1.48	17.4	1.51	17.3	1.52	17.2	1.53	16.7	1.55
63	59	17.9	1.45	17.7	1.46	17.6	1.49	17.5	1.50	17.4	1.50	17.0	1.52
68	64	18.0	1.43	17.8	1.45	17.7	1.47	17.7	1.47	17.6	1.48	17.2	1.49

DB: Dry Bulb Temperature (°F) WB: Wet Bulb Temperature (°F) TC: Total Capacity (kBtu/h)

PI: Power Input (kW) (includes compressor, indoor fan motor and outdoor fan motor)

1. All capacities are net, evaporator fan motor heat is deducted.
2. Direct interpolation is permissible. ⊙ Do not extrapolate.

Capacity as rated: 0 ft. above sea level with 24.6 ft. of refrigerant piping. 0 ft. level difference between outdoor and indoor units.

Heating capacity rating obtained with air entering the indoor unit at 70°F dry bulb (DB) and 60°F wet bulb (WB), and outdoor ambient conditions of 47°F dry bulb (DB) and 43°F wet bulb (WB).

MAXIMUM HEATING CAPACITY

KSUDB181A (KNUDB181A / KUSXB181A)

Table 43: KSUDB181A (KNUDB181A / KUSXB181A) Maximum Heating Capacities.

Outdoor Air Temp.		Indoor Air Temperature (°F DB)											
°F DB	°F WB	61		64		68		70		72		75	
		TC	PI	TC	PI	TC	PI	TC	PI	TC	PI	TC	PI
-4	-4.4	18.9	2.57	18.4	2.66	17.9	2.74	17.6	2.79	17.4	2.83	16.7	2.91
0	-0.4	19.5	2.64	19.1	2.73	18.5	2.82	18.2	2.87	18.0	2.91	17.3	2.99
5	4.5	20.3	2.73	19.9	2.82	19.3	2.91	19.0	2.96	18.8	3.00	18.1	3.09
10	9	21.1	2.67	20.7	2.75	20.1	2.84	19.8	2.89	19.5	2.93	18.8	3.02
17	15	22.3	2.58	21.8	2.66	21.1	2.74	20.8	2.79	20.5	2.83	19.8	2.91
20	19	22.6	2.54	22.1	2.62	21.5	2.70	21.1	2.75	20.8	2.79	20.1	2.87
25	23	23.2	2.48	22.7	2.56	22.0	2.64	21.7	2.69	21.4	2.73	20.6	2.80
30	28	23.8	2.42	23.2	2.50	22.6	2.58	22.2	2.62	21.9	2.66	21.1	2.73
35	32	24.3	2.36	23.8	2.44	23.1	2.51	22.7	2.56	22.4	2.59	21.6	2.67
40	36	24.9	2.30	24.3	2.38	23.6	2.45	23.3	2.49	23.0	2.53	22.1	2.60
45	41	25.5	2.24	24.9	2.31	24.2	2.39	23.8	2.43	23.5	2.46	22.6	2.53
47	43	25.7	2.22	25.1	2.29	24.4	2.36	24.00	2.400	23.7	2.44	22.8	2.50
50	46	25.8	2.20	25.3	2.26	24.6	2.33	24.3	2.36	24.0	2.39	23.2	2.46
55	51	25.9	2.18	25.5	2.23	25.0	2.28	24.7	2.31	24.5	2.33	23.8	2.38
60	56	26.0	2.15	25.7	2.20	25.4	2.23	25.1	2.25	25.0	2.26	24.3	2.30
63	59	26.1	2.14	25.8	2.17	25.6	2.21	25.4	2.22	25.3	2.22	24.7	2.25
68	64	26.2	2.12	25.9	2.15	25.8	2.18	25.7	2.18	25.6	2.19	25.0	2.21

DB: Dry Bulb Temperature (°F) WB: Wet Bulb Temperature (°F) TC: Total Capacity (kBtu/h)
 PI: Power Input (kW) (includes compressor, indoor fan motor and outdoor fan motor)

1. All capacities are net, evaporator fan motor heat is deducted.
2. Direct interpolation is permissible. ⊙ Do not extrapolate.

Capacity as rated: 0 ft. above sea level with 24.6 ft. of refrigerant piping. 0 ft. level difference between outdoor and indoor units.

Heating capacity rating obtained with air entering the indoor unit at 70°F dry bulb (DB) and 60°F wet bulb (WB), and outdoor ambient conditions of 47°F dry bulb (DB) and 43°F wet bulb (WB).

Performance Data

MAXIMUM HEATING CAPACITY

KSSCB241A (KNSCB241A / KUSXB241A)

Table 44: KSSCB241A (KNSCB241A / KUSXB241A) Maximum Heating Capacities.

Outdoor Air Temp.		Indoor Air Temperature (°F DB)											
°F DB	°F WB	61		64		68		70		72		75	
		TC	PI	TC	PI	TC	PI	TC	PI	TC	PI	TC	PI
-4	-4.4	22.5	2.79	22.0	2.89	21.3	2.98	21.0	3.03	20.7	3.07	20.0	3.16
0	-0.4	23.4	2.86	22.8	2.96	22.2	3.05	21.8	3.11	21.6	3.15	20.8	3.24
5	4.5	24.6	2.96	24.1	3.06	23.4	3.15	23.0	3.21	22.7	3.25	21.9	3.35
10	9	25.5	2.93	24.9	3.02	24.2	3.12	23.8	3.17	23.5	3.22	22.7	3.31
17	15	26.8	2.88	26.2	2.97	25.4	3.07	25.0	3.120	24.7	3.16	23.8	3.26
20	19	27.3	2.88	26.7	2.97	25.9	3.07	25.5	3.12	25.2	3.16	24.3	3.26
25	23	28.2	2.87	27.6	2.97	26.8	3.06	26.3	3.11	26.0	3.16	25.0	3.25
30	28	29.1	2.87	28.4	2.97	27.6	3.06	27.2	3.11	26.8	3.15	25.8	3.25
35	32	30.0	2.87	29.3	2.96	28.5	3.06	28.0	3.11	27.6	3.15	26.6	3.25
40	36	30.9	2.86	30.2	2.96	29.3	3.06	28.8	3.10	28.5	3.15	27.4	3.24
45	41	31.8	2.86	31.0	2.95	30.2	3.05	29.7	3.10	29.3	3.14	28.2	3.24
47	43	32.1	2.86	31.4	2.95	30.5	3.05	30.00	3.10	29.6	3.14	28.5	3.24
50	46	32.2	2.84	31.6	2.93	30.8	3.01	30.3	3.06	30.0	3.09	29.0	3.17
55	51	32.4	2.81	31.8	2.88	31.2	2.95	30.9	2.99	30.6	3.01	29.7	3.08
60	56	32.5	2.78	32.1	2.83	31.7	2.89	31.4	2.90	31.2	2.93	30.4	2.97
63	59	32.6	2.77	32.3	2.81	32.0	2.85	31.8	2.86	31.6	2.87	30.9	2.91
68	64	32.7	2.74	32.4	2.78	32.3	2.81	32.1	2.82	32.0	2.82	31.3	2.85

DB: Dry Bulb Temperature (°F) WB: Wet Bulb Temperature (°F) TC: Total Capacity (kBtu/h)

PI: Power Input (kW) (includes compressor, indoor fan motor and outdoor fan motor)

1. All capacities are net, evaporator fan motor heat is deducted.
2. Direct interpolation is permissible. ⓪ Do not extrapolate.

Capacity as rated: 0 ft. above sea level with 24.6 ft. of refrigerant piping. 0 ft. level difference between outdoor and indoor units.

Heating capacity rating obtained with air entering the indoor unit at 70°F dry bulb (DB) and 60°F wet bulb (WB), and outdoor ambient conditions of 47°F dry bulb (DB) and 43°F wet bulb (WB).

MAXIMUM HEATING CAPACITY

KSSCB301A (KNSCB301A / KUSXB301A)

Table 45: KSSCB301A (KNSCB301A / KUSXB301A) Maximum Heating Capacities.

Outdoor Air Temp.		Indoor Air Temperature (°F DB)											
°F DB	°F WB	61		64		68		70		72		75	
		TC	PI	TC	PI	TC	PI	TC	PI	TC	PI	TC	PI
-4	-4.4	28.9	3.71	28.2	3.84	27.4	3.96	27.0	4.03	26.7	4.08	25.7	4.20
0	-0.4	31.1	3.83	30.4	3.97	29.6	4.09	29.1	4.16	28.7	4.22	27.7	4.35
5	4.5	34.3	4.01	33.5	4.15	32.5	4.27	32.0	4.35	31.6	4.41	30.4	4.54
10	9	35.1	3.92	34.3	4.05	33.3	4.17	32.8	4.25	32.3	4.30	31.1	4.43
17	15	36.2	3.79	35.4	3.91	34.4	4.03	33.8	4.10	33.4	4.16	32.1	4.28
20	19	36.5	3.78	35.7	3.90	34.7	4.02	34.1	4.09	33.7	4.15	32.4	4.27
25	23	37.1	3.76	36.3	3.88	35.2	4.01	34.7	4.07	34.2	4.13	33.0	4.25
30	28	37.7	3.74	36.8	3.87	35.8	3.99	35.2	4.06	34.7	4.11	33.5	4.24
35	32	38.2	3.72	37.4	3.85	36.3	3.98	35.7	4.04	35.2	4.09	34.0	4.22
40	36	38.8	3.71	37.9	3.83	36.9	3.96	36.3	4.02	35.8	4.08	34.5	4.20
45	41	39.4	3.69	38.5	3.82	37.4	3.94	36.8	4.01	36.3	4.06	35.0	4.19
47	43	39.6	3.68	38.7	3.81	37.6	3.94	37.00	4.000	36.5	4.05	35.2	4.18
50	46	39.7	3.66	38.9	3.78	38.0	3.88	37.4	3.95	37.0	3.99	35.7	4.09
55	51	39.9	3.63	39.3	3.72	38.5	3.80	38.1	3.85	37.7	3.88	36.6	3.97
60	56	40.1	3.59	39.6	3.65	39.1	3.73	38.8	3.75	38.5	3.78	37.5	3.83
63	59	40.2	3.57	39.8	3.62	39.4	3.67	39.2	3.69	39.0	3.71	38.1	3.76
68	64	40.3	3.54	40.0	3.59	39.8	3.63	39.6	3.64	39.4	3.64	38.6	3.67

DB: Dry Bulb Temperature (°F) WB: Wet Bulb Temperature (°F) TC: Total Capacity (kBtu/h)
 PI: Power Input (kW) (includes compressor, indoor fan motor and outdoor fan motor)

1. All capacities are net, evaporator fan motor heat is deducted.
2. Direct interpolation is permissible. ⊙ Do not extrapolate.

Capacity as rated: 0 ft. above sea level with 24.6 ft. of refrigerant piping. 0 ft. level difference between outdoor and indoor units.

Heating capacity rating obtained with air entering the indoor unit at 70°F dry bulb (DB) and 60°F wet bulb (WB), and outdoor ambient conditions of 47°F dry bulb (DB) and 43°F wet bulb (WB).

Performance Data

MAXIMUM HEATING CAPACITY

KSSCB361A (KNSCB361A / KUSXB361A)

Table 46: KSSCB361A (KNSCB361A / KUSXB361A) Maximum Heating Capacities.

Outdoor Air Temp.		Indoor Air Temperature (°F DB)											
°F DB	°F WB	61		64		68		70		72		75	
		TC	PI	TC	PI	TC	PI	TC	PI	TC	PI	TC	PI
-4	-4.4	33.7	4.66	32.9	4.82	32.0	4.97	31.5	5.06	31.0	5.13	29.9	5.28
0	-0.4	35.4	4.60	34.6	4.75	33.6	4.90	33.0	4.98	32.6	5.06	31.4	5.21
5	4.5	37.5	4.52	36.6	4.65	35.6	4.80	35.0	4.89	34.5	4.96	33.3	5.11
10	9	38.8	4.68	37.9	4.83	36.8	4.98	36.3	5.07	35.8	5.14	34.5	5.30
17	15	40.7	4.91	39.8	5.07	38.6	5.23	38.0	5.32	37.5	5.40	36.1	5.56
20	19	41.1	4.79	40.2	4.95	39.1	5.10	38.4	5.19	37.9	5.27	36.5	5.42
25	23	41.9	4.60	40.9	4.75	39.8	4.90	39.1	4.98	38.6	5.06	37.2	5.20
30	28	42.6	4.40	41.7	4.55	40.5	4.69	39.8	4.77	39.3	4.84	37.9	4.98
35	32	43.4	4.21	42.4	4.35	41.2	4.48	40.5	4.56	40.0	4.63	38.5	4.75
40	36	44.1	4.01	43.1	4.14	41.9	4.28	41.2	4.35	40.7	4.41	39.2	4.53
45	41	44.9	3.82	43.9	3.94	42.6	4.07	41.9	4.13	41.4	4.20	39.9	4.31
47	43	45.2	3.74	44.2	3.86	42.9	3.99	42.20	4.050	41.6	4.11	40.1	4.22
50	46	45.3	3.71	44.4	3.82	43.3	3.93	42.7	3.99	42.2	4.03	40.7	4.14
55	51	45.5	3.68	44.8	3.77	43.9	3.85	43.4	3.89	43.0	3.93	41.8	4.02
60	56	45.7	3.63	45.2	3.71	44.6	3.77	44.2	3.80	43.9	3.82	42.8	3.88
63	59	45.9	3.61	45.4	3.66	45.0	3.72	44.7	3.74	44.4	3.75	43.4	3.80
68	64	46.0	3.58	45.6	3.63	45.4	3.68	45.2	3.68	45.0	3.69	44.0	3.72

DB: Dry Bulb Temperature (°F) WB: Wet Bulb Temperature (°F) TC: Total Capacity (kBtu/h)

PI: Power Input (kW) (includes compressor, indoor fan motor and outdoor fan motor)

1. All capacities are net, evaporator fan motor heat is deducted.
2. Direct interpolation is permissible. ⚠ Do not extrapolate.

Capacity as rated: 0 ft. above sea level with 24.6 ft. of refrigerant piping. 0 ft. level difference between outdoor and indoor units.

Heating capacity rating obtained with air entering the indoor unit at 70°F dry bulb (DB) and 60°F wet bulb (WB), and outdoor ambient conditions of 47°F dry bulb (DB) and 43°F wet bulb (WB).

MAXIMUM HEATING CAPACITY

KSSCB421A (KNSCB421A / KUSXB421A)

Table 47: KSSCB421A (KNSCB421A / KUSXB421A) Maximum Heating Capacities.

Outdoor Air Temp.		Indoor Air Temperature (°F DB)											
°F DB	°F WB	61		64		68		70		72		75	
		TC	PI	TC	PI	TC	PI	TC	PI	TC	PI	TC	PI
-4	-4.4	37.7	5.41	36.9	5.60	35.8	5.77	35.2	5.87	34.7	5.96	33.5	6.13
0	-0.4	39.8	5.43	38.9	5.61	37.8	5.79	37.2	5.89	36.7	5.98	35.3	6.15
5	4.5	42.4	5.47	41.4	5.63	40.3	5.82	39.6	5.92	39.1	6.00	37.6	6.19
10	9	43.2	5.37	42.3	5.54	41.1	5.71	40.4	5.82	39.9	5.90	38.4	6.08
17	15	44.4	5.24	43.4	5.40	42.2	5.57	41.5	5.67	40.9	5.75	39.5	5.92
20	19	45.3	5.17	44.3	5.33	43.0	5.50	42.3	5.60	41.8	5.68	40.2	5.84
25	23	46.8	5.05	45.7	5.22	44.4	5.38	43.7	5.47	43.1	5.55	41.6	5.71
30	28	48.3	4.94	47.2	5.10	45.8	5.26	45.1	5.35	44.5	5.43	42.9	5.58
35	32	49.8	4.82	48.6	4.98	47.2	5.14	46.5	5.23	45.9	5.30	44.2	5.45
40	36	51.2	4.71	50.1	4.87	48.7	5.02	47.9	5.10	47.2	5.18	45.5	5.32
45	41	52.7	4.60	51.5	4.75	50.1	4.90	49.2	4.98	48.6	5.06	46.8	5.19
47	43	53.3	4.55	52.1	4.70	50.6	4.85	49.80	4.93	49.1	5.01	47.3	5.14
50	46	53.5	4.51	52.4	4.65	51.1	4.78	50.3	4.85	49.8	4.91	48.1	5.04
55	51	53.7	4.47	52.8	4.59	51.9	4.68	51.3	4.74	50.8	4.78	49.3	4.89
60	56	54.0	4.42	53.3	4.51	52.6	4.59	52.2	4.63	51.8	4.65	50.5	4.72
63	59	54.1	4.40	53.6	4.46	53.1	4.53	52.7	4.55	52.4	4.57	51.2	4.63
68	64	54.3	4.36	53.8	4.42	53.6	4.47	53.3	4.47	53.1	4.49	51.9	4.53

DB: Dry Bulb Temperature (°F) WB: Wet Bulb Temperature (°F) TC: Total Capacity (kBtu/h)

PI: Power Input (kW) (includes compressor, indoor fan motor and outdoor fan motor)

1. All capacities are net, evaporator fan motor heat is deducted.

2. Direct interpolation is permissible. ⚠ Do not extrapolate.

Capacity as rated: 0 ft. above sea level with 24.6 ft. of refrigerant piping. 0 ft. level difference between outdoor and indoor units.

Heating capacity rating obtained with air entering the indoor unit at 70°F dry bulb (DB) and 60°F wet bulb (WB), and outdoor ambient conditions of 47°F dry bulb (DB) and 43°F wet bulb (WB).

Performance Data

MAXIMUM HEATING CAPACITY

KSSCB481A (KNSCB481A / KUSXB481A)

Table 48: KSSCB481A (KNSCB481A / KUSXB481A) Maximum Heating Capacities.

Outdoor Air Temp.		Indoor Air Temperature (°F DB)											
°F DB	°F WB	61		64		68		70		72		75	
		TC	PI	TC	PI	TC	PI	TC	PI	TC	PI	TC	PI
-4	-4.4	39.6	5.68	38.7	5.88	37.6	6.06	37.0	6.16	36.5	6.25	35.1	6.43
0	-0.4	41.0	5.61	40.1	5.79	38.9	5.98	38.3	6.08	37.8	6.17	36.4	6.35
5	4.5	42.8	5.52	41.9	5.69	40.7	5.88	40.0	5.98	39.5	6.06	38.0	6.25
10	9	43.5	5.40	42.5	5.57	41.3	5.75	40.6	5.85	40.1	5.93	38.6	6.11
17	15	44.4	5.24	43.4	5.40	42.2	5.57	41.5	5.67	40.9	5.75	39.5	5.92
20	19	45.8	5.21	44.7	5.37	43.5	5.54	42.8	5.64	42.2	5.72	40.6	5.89
25	23	48.0	5.16	46.9	5.33	45.6	5.49	44.8	5.59	44.2	5.67	42.6	5.83
30	28	50.2	5.11	49.1	5.28	47.7	5.45	46.9	5.54	46.3	5.62	44.6	5.78
35	32	52.4	5.07	51.3	5.23	49.8	5.40	49.0	5.49	48.4	5.57	46.6	5.73
40	36	54.7	5.02	53.5	5.19	51.9	5.35	51.1	5.44	50.4	5.52	48.6	5.67
45	41	56.9	4.98	55.6	5.14	54.0	5.31	53.2	5.39	52.5	5.47	50.5	5.62
47	43	57.8	4.96	56.5	5.12	54.9	5.29	54.00	5.37	53.3	5.45	51.3	5.60
50	46	58.0	4.92	56.8	5.06	55.4	5.20	54.6	5.29	54.0	5.35	52.1	5.49
55	51	58.3	4.87	57.3	5.00	56.2	5.10	55.6	5.16	55.1	5.20	53.4	5.33
60	56	58.5	4.81	57.8	4.92	57.1	5.00	56.6	5.04	56.2	5.06	54.8	5.14
63	59	58.7	4.79	58.1	4.85	57.6	4.94	57.2	4.96	56.8	4.98	55.5	5.04
68	64	58.9	4.75	58.4	4.81	58.1	4.87	57.8	4.87	57.5	4.89	56.3	4.94

DB: Dry Bulb Temperature (°F) WB: Wet Bulb Temperature (°F) TC: Total Capacity (kBtu/h)
 PI: Power Input (kW) (includes compressor, indoor fan motor and outdoor fan motor)

1. All capacities are net, evaporator fan motor heat is deducted.
2. Direct interpolation is permissible. ⊙ Do not extrapolate.

Capacity as rated: 0 ft. above sea level with 24.6 ft. of refrigerant piping, 0 ft. level difference between outdoor and indoor units.

Heating capacity rating obtained with air entering the indoor unit at 70°F dry bulb (DB) and 60°F wet bulb (WB), and outdoor ambient conditions of 47°F dry bulb (DB) and 43°F wet bulb (WB).

CORRECTION FACTORS

Cooling / Heating Correction Factors

For single zone systems, calculate the equivalent length of the liquid line from the outdoor unit to the indoor unit. Also, determine the elevation difference of the indoor unit above or below the outdoor unit. Find corresponding cooling or heating capacity correction factors as shown below. Multiply the correction factors by the cooling or heating capacity obtained from the capacity table using design conditions. The resultant is the NET cooling or heating capacity.

Refrigerant Line Length Derates

For air-cooled systems, a capacity correction factor will have to be applied to account for the length of the system's refrigerant pipe. Rate of change in capacity due to increased piping lengths is shown below.

Table 49: R32 Single-Zone Four-Way Cassette System Cooling and Heating Capacity Coefficient Factors.

Piping Length (ft.)		24.6	32.8	49.2	65.6	98.4	131.2	164	196.9	229.7	246
<i>Cooling Capacity Coefficient Factor</i>											
Rate of Capacity Change (%)	KSUDB091A (9,000 Btu/h)	100	100	100	99.3	-	-	-	-	-	-
	KSUDB121A (12,000 Btu/h)	100	100	100	99.3	-	-	-	-	-	-
	KSUDB181A (18,000 Btu/h)	100	100	99	98.1	96.1	94.3	92.1	-	-	-
	KSSCB241A (24,000 Btu/h)	100	100	99	98.1	96.1	94.3	92.1	-	-	-
	KSSCB301A (30,000 Btu/h)	100	100	99	98.1	96.1	94.3	92.1			
	KSSCB361A (36,000 Btu/h)	100	98.8	97.5	96.3	93.8	91.3	88.8	86.3	83.8	82.5
	KSSCB421A (42,000 Btu/h)	100	98.8	97.5	96.3	93.8	91.3	88.8	86.3	83.8	82.5
	KSSCB481A (48,000 Btu/h)	100	98.8	97.5	96.3	93.8	91.3	88.8	86.3	83.8	82.5
<i>Heating Capacity Coefficient Factor</i>											
Rate of Capacity Change (%)	KSUDB091A (9,000 Btu/h)	100	99.8	99.4	99	-	-	-	-	-	-
	KSUDB121A (12,000 Btu/h)	100	99.8	99.4	99	-	-	-	-	-	-
	KSUDB181A (18,000 Btu/h)	100	99.8	99.4	99	98.3	97.2	96.2	-	-	-
	KSSCB241A (24,000 Btu/h)	100	99.8	99.4	99	98.3	97.2	96.2	-	-	-
	KSSCB301A (30,000 Btu/h)	100	99.7	99.2	98.7	97.7	96.6	95.6	-	-	-
	KSSCB361A (36,000 Btu/h)	100	99.7	98.4	97	96	94.9	93.9	92.9	91.8	91.3
	KSSCB421A (42,000 Btu/h)	100	99.7	98.4	97	96	94.9	93.9	92.9	91.8	91.3
	KSSCB481A (48,000 Btu/h)	100	99.7	98.4	97	96	94.9	93.9	92.9	91.8	91.3

Performance Data

Equivalent Piping Length for Piping Components

Table 50: Equivalent Piping Length for Elbows.

Component	Size (Inches)													
	1/4	3/8	1/2	5/8	3/4	7/8	1	1-1/8	1-1/4	1-3/8	1-1/2	1-5/8	1-3/4	2-1/8
Elbow (ft.)	0.5	0.6	0.7	0.8	1.2	1.3	1.5	1.6	1.8	2.0	2.1	2.3	2.5	2.8

Altitude Correction Factor

The impact of air density must be considered on systems installed at a significant altitude above sea level, therefore, locally accepted altitude correction factors must be applied.

CORRECTION FACTORS / CHECK SELECTION

Defrost Correction Factor for Heating Operation

The outdoor unit heating capacity will need to be adjusted for frost accumulation on air-cooled systems. If design day conditions are below the dewpoint of the surrounding air, frost will not be a problem and no correction factor is needed. In certain weather conditions, however, frost will form and accumulate on the air-cooled outdoor unit coil and impact the coils ability to transfer heat. If significant frost accumulates on the outdoor unit coil, a defrost algorithm will start automatically. The timing between defrost periods is determined by the system's ability to achieve a target head pressure value.

Capacity and AHRI ratings tables do not factor in capacity reduction when frost has accumulated on the condenser coil, nor during defrost operation.

Integrated heating capacity values can be obtained using the formula: **Table 51: Outdoor Unit Frost Accumulation Factor (Heating)1.**

$$A = B \times C$$

Where:

A = Integrated Heating Capacity.

B = Value found in the Capacity Table.

C = Correction Factor for Frost Accumulation Factor (from table at right).

Entering DB (°F)	19.4	23.0	26.6	32.0	37.4	41.0	44.6
Derate Factor	0.98	0.95	0.93	0.86	0.93	0.96	1.0

¹At 85% outdoor air relative humidity.

The frost accumulation factor does not account for effects of snow accumulation restricting airflow through the outdoor unit coil.

NOTICE

There will be a temporary reduction in capacity when frost / ice accumulates on the outside surface of the outdoor unit heat exchanger. The level of capacity reduction depends on a number of factors, for example, outdoor temperature (°F DB), relative humidity (RH), and the amount of frost present.

Check the Indoor and Outdoor Unit Selection(s)

Compare the corrected cooling and heating capacities to the load calculations. Is each capacity sufficient for the zone it serves?

For each indoor unit, the corrected capacity must be at least equal to the total of the cooling design load (plus ventilation load, if applicable) for the space(s) served by the indoor unit. For each indoor unit, the corrected capacity also must be at least equal to the total of the heating design load (plus ventilation load, if applicable) for the space(s) and / or thermal zones served by the indoor unit.

The outdoor unit selected must be large enough to offset the total cooling load for all spaces it serves (account for ventilation air cooling load if the ventilation air has not been pretreated to room neutral conditions). The outdoor unit must also be large enough to offset the total heating load for all spaces it serves.

If the corrected heating capacity ratio exceeds 100%, reselect the equipment, or change the system design by moving some of the load to another system.

System Sizing Check Formulas

1. Outdoor Unit Rated Capacity.

$Q_{odu(rated)}$ (From capacity tables).

2. Outdoor Unit Capacity at T_i , T_o Temperature.

$Q_{odu(T_i, T_o)}$ (From capacity tables).

3. Outdoor Unit Capacity Coefficient Factor.

$F_{(T_i, T_o)} = Q_{odu(T_i, T_o)} / Q_{odu(rated)}$

4. Piping Correction Factor (From Capacity Coefficient Factor Tables).

$F_{(length)}$ for each piping length

5. Individual Indoor Unit Combination Capacity.

$Q_{idu(combi)} = Q_{odu(rated)} \times Q_{idu(rated)} / Q_{idu(rated-total)}$

6. Individual Indoor Unit Actual Capacity.

$Q_{idu(actual)} = Q_{odu(combi)} \times F_{(T_i, T_o)} \times F_{(length, altitude)}$

Conclusions and Recommendations

- Understand the design safety factors.
- Reference load calculations for actual cooling and heating capacities (applies in 99% of applications – consider total load when latent load is greater than 30%).
- Verify that the sensible load of the zone is satisfied.
- Use caution when sizing to meet listed capacity specifications for the scheduled manufacturer's equipment.

If further system design assistance is needed, or you have a unique application you would like to discuss, contact an LG sales rep.

APPLICATION GUIDELINES

Placement / Clearance Considerations for Indoor Units on page 76

Placement / Clearance Considerations for Outdoor Units on page 78

Installing Outdoor Units Indoors on page 84

PLACEMENT / CLEARANCE REQUIREMENTS

Indoor Units

Selecting the Best Location for the Indoor Unit

NOTICE

Follow recommended best practices when choosing an indoor location for the single zone indoor unit.

Do's

Select a location for installing the indoor units that will meet the following conditions:

- Place the unit where air circulation will not be blocked.
- Locate the indoor unit in a location that is level, with enough strength to bear the weight of the indoor unit(s), and where it can be easily connected to the outdoor unit.
- Place the unit where drainage can be obtained easily and to minimize the length of the condensate drain piping; include space for drainage to ensure condensate flows properly out of the unit when it is in cooling mode.
- Include enough space around the indoor unit so that it is accessible for maintenance and service purposes. Include enough space to be able to clean the filter.
- Place the unit in a location where electrical noise / electromagnetic waves will not impact operation. Maintain proper distances between the indoor units and electric wires, audio and visual appliances, breaker / circuit panels, etc.
- Place the unit where operating sound from the unit will not disturb occupants.
- Confirm that there is enough space for and between the indoor unit and any mounting hardware.

Do Not's

- No obstacles to air circulation around the unit; keep proper distances from ceilings, doorways, floor, walls, etc.
- The unit should not be installed near a heat or steam source, or where considerable amounts of oil, iron powder, or flour are used. (These materials may generate condensate, cause a reduction in heat exchanger efficiency, or the drain to malfunction. If this is a potential problem, install a ventilation fan large enough to vent out these materials.)
- Avoid installing the unit near high-frequency generators or near any equipment that generates an electromagnetic field (minimum 3-1/3 feet away).

Figure 26: Cassette Indoor Unit Clearance Requirements.

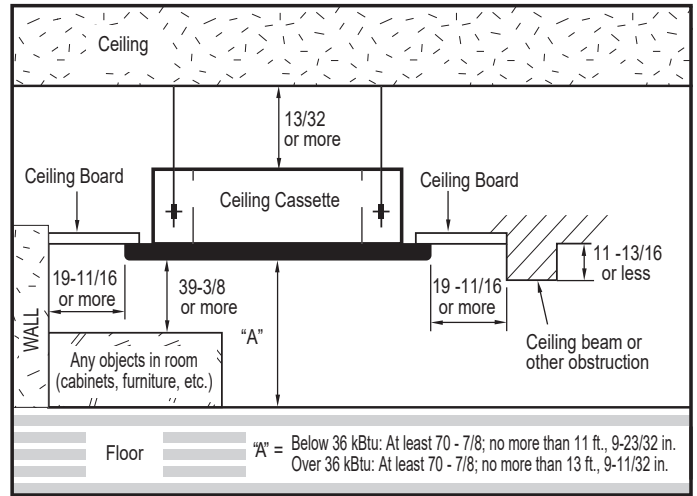

Figure 27: 2 x 2 Cassette Ceiling Opening Dimensions and Bolt Locations.

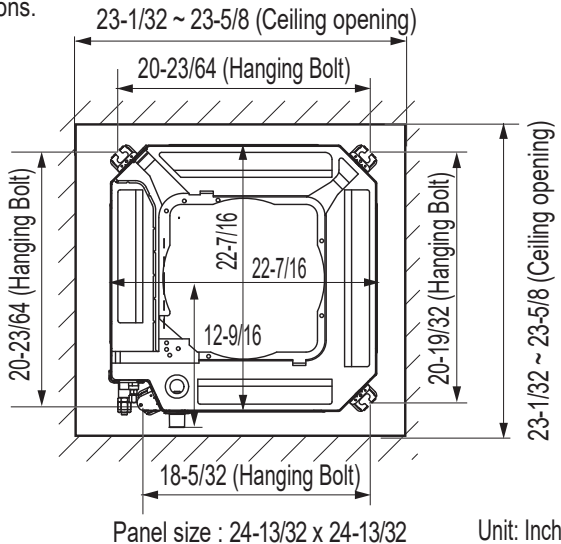
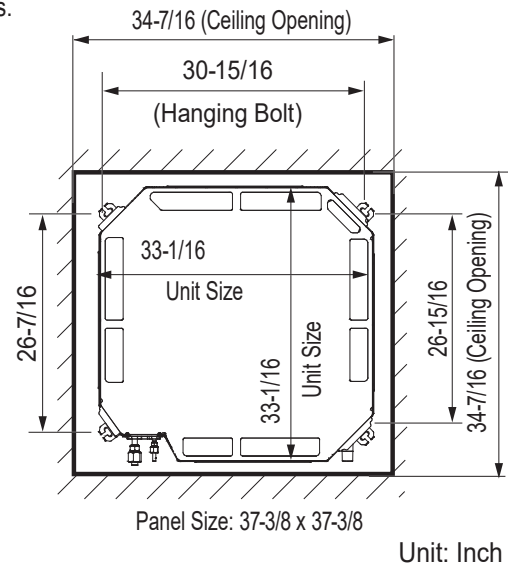

Figure 28: 3 x 3 Cassette Ceiling Opening Dimensions and Bolt Locations.



PLACEMENT / CLEARANCE CONSIDERATIONS

Indoor Units

⚠ WARNING

The unit must not be installed where oil, sulfuric acid and flammable or corrosive gases are generated, vented into, or stored. There is risk of fire, explosion, and physical injury or death.

NOTICE

⊘ Indoor units (IDUs) must not be placed in an environment where the IDUs will be exposed to harmful volatile organic compounds (VOCs) or in environments where there is improper air make up or supply or inadequate ventilation. If there are concerns about VOCs in the environment where the IDUs are installed, proper air make up or supply and / or adequate ventilation should be provided. Additionally, in buildings where IDUs will be exposed to VOCs consider a factory-applied epoxy coating to the fan coils for each IDU.

• If the unit is installed near a body of water, the installation parts are at risk of corroding. Appropriate anti-corrosion methods must be taken for the unit and all installation parts.

The unit will be damaged, will malfunction, and / or will not operate as designed if installed in any of the conditions listed.

Installing in a High or Dropped Ceiling

High or dropped ceilings, often found in commercial buildings and offices, will cause a wide temperature differentiation. To countermeasure:

- Change the indoor unit mode selection to allow for higher ceilings (see table).
- Install an air circulator.
- Set the air discharge outlet so that heated air flows in a downward direction.
- Use a dual door system to protect the building gate or exit.

Table 52: 2 x 2 Indoor Unit High Ceiling Mode Selection Options (KNUDB091A, KNUDB121A, KNUDB181A).

Ceiling Height	Mode Selection
≤7-1/2 feet	Low Ceiling
7-1/2 feet to 8-7/8 feet	Standard
8-7/8 feet to 10-3/16 feet	High Ceiling
10-3/16 feet to 11-13/16 feet	Very High Ceiling

Table 53: 3 x 3 Indoor Unit High Ceiling Mode Selection Options (KNSCB241A, KNSCB301A, KNSCB361A, KNSCB421A, KNSCB481A).

Ceiling Height	Mode Selection
≤8-7/8 feet	Low Ceiling
8-7/8 feet to 10-1/2 feet	Standard
10-1/2 feet to 11-13/16 feet	High Ceiling
11-13/16 feet to 13-13/16 feet	Very High Ceiling

Installing in an Area Exposed to Unconditioned Air

In some installation applications, areas (floors, walls) in some rooms will be exposed to unconditioned air (room will be above or next to an unheated garage or storeroom). To countermeasure:

- Verify that carpet is or will be installed (carpet will increase the temperature by three degrees).
- Add insulation between the floor joists.
- Install radiant heat or another type of heating system to the floor.

Installing in an Area with High Humidity Levels

If the environment is prone to humidity levels of 80% or more (near the ocean, lakes, etc.) or where steam could collect in the plenum:

- Install additional insulation to the indoor unit (glass wool insulation >13/32 inches thick).
- Install additional insulation to the refrigerant piping (insulation >13/16 inches thick).
- Seal all gaps between the indoor unit and the ceiling tiles (make the area air tight) so that humidity does not transfer from the plenum to the conditioned space. Also, add a ceiling grille for ventilation.

Figure 29: Installing Near a Heat or Steam Source.

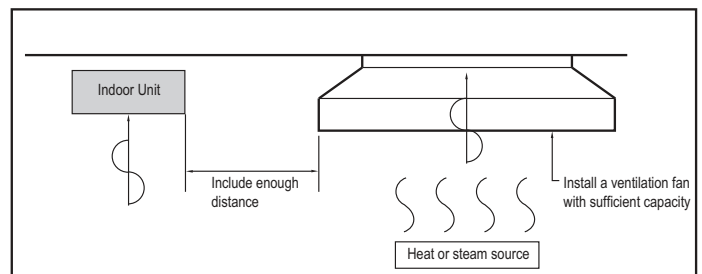



PLACEMENT / CLEARANCE CONSIDERATIONS

Outdoor Units

Selecting the Best Location for the Outdoor Unit

⚠ DANGER

-  Do not install the unit in an area where combustible gas will generate, flow, stagnate, or leak. These conditions can cause a fire, resulting in bodily injury or death.
-  Do not install the unit in a location where acidic solution and spray (sulfur) are often used as it can cause bodily injury or death.
-  Do not use the unit in environments where oil, steam, or sulfuric gas are present as it can cause bodily injury or death.

⚠ WARNING

When deciding on a location to place the outdoor unit, be sure to choose an area where run-off from defrost will not accumulate and freeze on sidewalks or driveways, which will create unsafe conditions. Properly install and insulate any drain hoses to prevent the hose from freezing, cracking, leaking, and causing unsafe conditions from frozen condensate.

Install a fence to prevent pests from crawling into the unit or unauthorized individuals from accessing it. Pests and unauthorized individuals can damage internal components which can cause a fire, electric shock, physical injury or death. Follow the placement guidelines set forth in "Clearance Requirements".

Select a location for installing the outdoor unit that will meet the following conditions:

Do's

- Where there is enough strength to bear the weight of the unit.
- A location that allows for optimum air flow and is easily accessible for inspection, maintenance, and service.
- Where piping between the outdoor unit and indoor unit is within allowable limits.
- Include space for drainage to ensure condensate flows properly out of the unit when it is in heating mode.  Avoid placing the outdoor unit in a low-lying area where water could accumulate.
- If the outdoor unit is installed in a highly humid environment (near an ocean, lake, etc.), ensure that the site is well-ventilated and has a lot of natural light (Example: Install on a rooftop).

Do Nots

- Where it will be subjected to direct thermal radiation from other heat sources, or an area that would expose the outdoor unit to heat or steam like discharge from boiler stacks, chimneys, steam relief ports, other air conditioning units, kitchen vents, plumbing vents, and other sources of extreme temperatures.
- Where high-frequency electrical noise / electromagnetic waves will affect operation.
- Where operating sound from the unit will disturb inhabitants of surrounding buildings.
- Where the unit will be exposed to direct, strong winds.
- Where the discharge of one outdoor unit will blow into the inlet side of an adjacent unit (when installing multiple outdoor units).

NOTICE

The indoor unit may take longer to provide heat, or heating performance will be reduced in winter if the outdoor unit is installed:

1. In a narrow, shady location.
2. Near a location that has a lot of ground moisture.
3. In a highly humid environment.
4. In an area in which condensate does not drain properly.

Outdoor Unit Condensate Drain Piping

Outdoor unit requires condensate drain piping. Condensate drain pipe is constructed with materials approved by local code. See pages 80 to 83 for information in reference to outdoor unit placement.

PLACEMENT / CLEARANCE CONSIDERATIONS

Outdoor Units

Planning for Snow and Ice

To ensure the outdoor unit operates properly, certain measures are required in locations where there is a possibility of heavy snowfall or severe windchill or cold:

1. Prepare for severe winter wind chills and heavy snowfall, even in areas of the country where these are unusual phenomena.
2. Position the outdoor unit so that its airflow fans are not buried by direct, heavy snowfall. If snow piles up and blocks the airflow, the system will malfunction.
3. Remove any snow that has accumulated four (4) inches or more on the top of the outdoor unit.
4. In climates that will experience significant snow buildup, mount the outdoor unit on a raised, field-provided platform or stand. The raised support platform must be high enough to allow the unit to remain above possible snow drifts, and must be higher than the maximum anticipated snowfall for the location.
5. Design the mounting base to prevent snow accumulation on the platform in front or back of the unit frame.
6. Provide a field fabricated snow protection hood to keep snow and ice and/or drifting snow from accumulating on the coil surfaces.
7. To prevent snow and heavy rain from entering the outdoor unit, install the condenser air inlets and outlets facing away from direct winds.
8. Consider tie-down requirements in case of high winds or where required by local codes.

⚠ CAUTION

When deciding on a location to place the outdoor unit, be sure to choose an area where run-off from defrost will not accumulate and freeze on sidewalks or driveways, which will create unsafe conditions.

NOTICE

Choose an area where run-off from defrost mode will not accumulate and freeze on sidewalks or driveways. Properly install and insulate any drain hoses to prevent the hose from freezing, cracking, leaking, and damaging the outdoor unit.

Tie-Downs, Lightning Protection, and Wind Protection

Tie-Downs

- The strength of the roof must be checked before installing the outdoor units.
- The strength of the outdoor unit frames is adequate to be used with field-provided wind restraint tie-downs.
- If the installation site is prone to high winds or earthquakes, when installing on the wall or roof, securely anchor the mounting base using a field-provided tie-down configuration approved by a local professional engineer.
- The overall tie-down configuration must be approved by a local professional engineer.

NOTICE

Always refer to local code when using a wind restraint system.

Lightning Protection

- To protect the outdoor unit from lightning, it must be placed within the specified lightning safety zone.

Table 54: Safety Zone Specifications.

Building Height (feet)	66	98	148	197
Protection Angle (°)	55	45	35	25

- Power cable and communication cable must be installed five (5) feet away from lightning rod.
- A high-resistance ground system must be included to protect against induced lightning or indirect strike.

Figure 30: Lightning Protection Diagram (Outdoor Unit Appearances Differ According to Model).

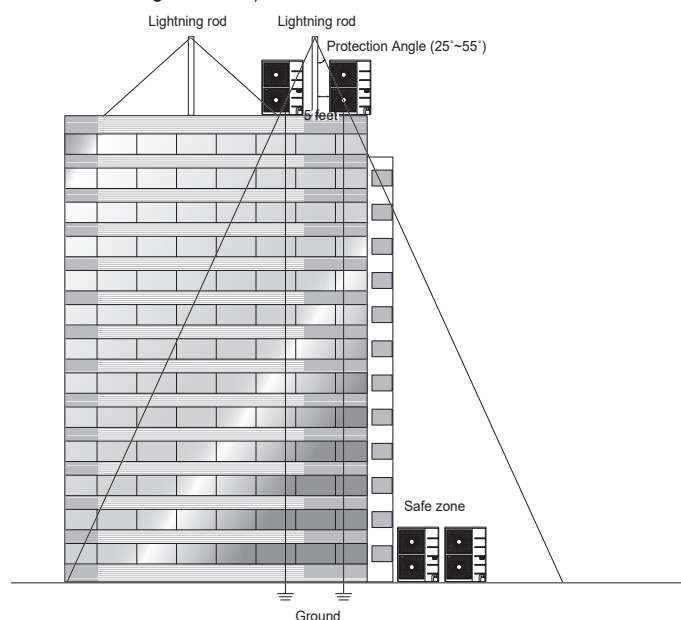

NOTICE

If the building does not include lightning protection, the outdoor unit will be damaged from a lightning strike. Inform the customer of this possibility in advance.

PLACEMENT / CLEARANCE CONSIDERATIONS

Outdoor Units

Oceanside Applications

Wind Protection

If the outdoor unit is placed on a roof, position it with the compressor end (no coil surface) in the direction of the prevailing wind as shown in the figure at right. In cooler climates, it may be beneficial to position the unit in direct sunlight to assist with defrost operations.

If the outdoor unit is not placed on a roof, place it on the leeward side of the building or in a location where the unit will not be exposed to constant wind.

If placement exposes the unit to constant wind activity, construct a wind break in front of the unit. Follow the placement guidelines set forth in "Clearance Requirements".

Figure 31: Prevailing Wind Direction.

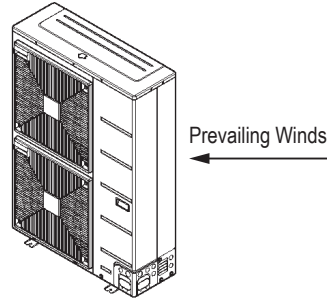
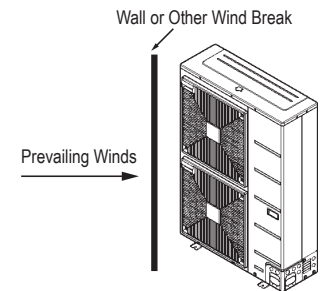

Figure 32: Leeward Side of the Building.



Figure 33: Wind Break.



Oceanside Application Precautions

NOTICE

Ocean winds will cause corrosion, particularly on the condenser and evaporator fins, which, in turn could cause product malfunction or inefficient performance.

- ⚠ Avoid installing the outdoor unit where it would be directly exposed to ocean winds.
- Install the outdoor unit on the side of the building opposite from direct ocean winds.
- Select a location with good drainage.
- Periodically clean dust or salt particles off of the heat exchanger with water.

If the outdoor unit must be placed in a location where it would be subjected to direct ocean winds, install a concrete windbreaker strong enough to block any winds. Windbreaker height and width must be more than 150% of the outdoor unit, and be installed at least 14 to 28 inches away from the outdoor unit to allow for airflow (depending on the location and outdoor unit size).

Figure 34: Oceanside Placement Using a Building as Shield, and Placement Using a Windbreaker.

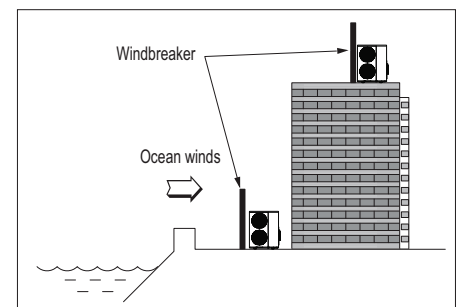
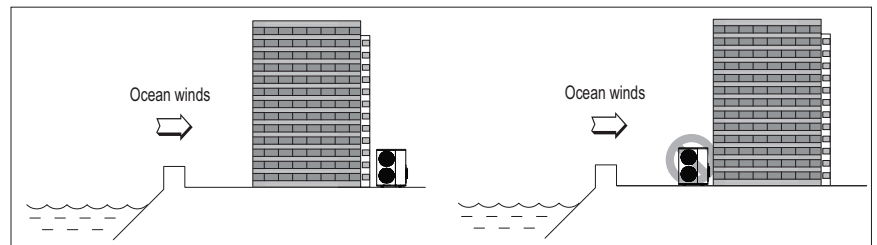

NOTICE

Additional anti-corrosion treatment may need to be applied to the outdoor unit at oceanside locations.

PLACEMENT / CLEARANCE CONSIDERATIONS

Outdoor Units

Minimum Allowable Clearance and Service Access Requirements

Proper clearance for the outdoor unit coil is critical for proper unit operation. When installing the outdoor unit, consider service, inlet and outlet and minimum allowable space requirements as illustrated in the diagrams on the following pages.

- Include enough space for airflow and for service access. If installing multiple outdoor units, ⚠ avoid placing the units where the discharge of one unit will blow into the inlet side of an adjacent unit.
- If an awning is built over the unit to prevent direct sunlight or rain exposure, make sure that the discharge air of the outdoor unit isn't restricted.
- ⚠ No obstacles to air circulation around the unit; keep proper distances from ceilings, fences, floor, walls, etc. (Install a fence to prevent pests from damaging the unit or unauthorized individuals from accessing it.)

Minimum Clearance Requirements for Single Fan Outdoor Units

Specific clearance requirements in the diagram below are for single fan outdoor units. The figure below shows the overall minimum clearances that must be observed for safe operation and adequate airflow around the outdoor unit.

When placing the outdoor unit under an overhang, awning, sunroof or other "roof-like structure", observe the clearance requirements (as shown in Cases 1 and 2) for height in relation to the unit. To have successful service access to the outdoor unit, see the figure below for minimum spacing. When installing multiple outdoor units, see Cases 4 and 5 for correct spacing requirements.

NOTICE

If the outdoor unit is installed between standard and minimum clearances, capacity decreases approximately 10%.

Figure 35: Single Fan Outdoor Unit Service Access and Allowable Clearances Diagram.

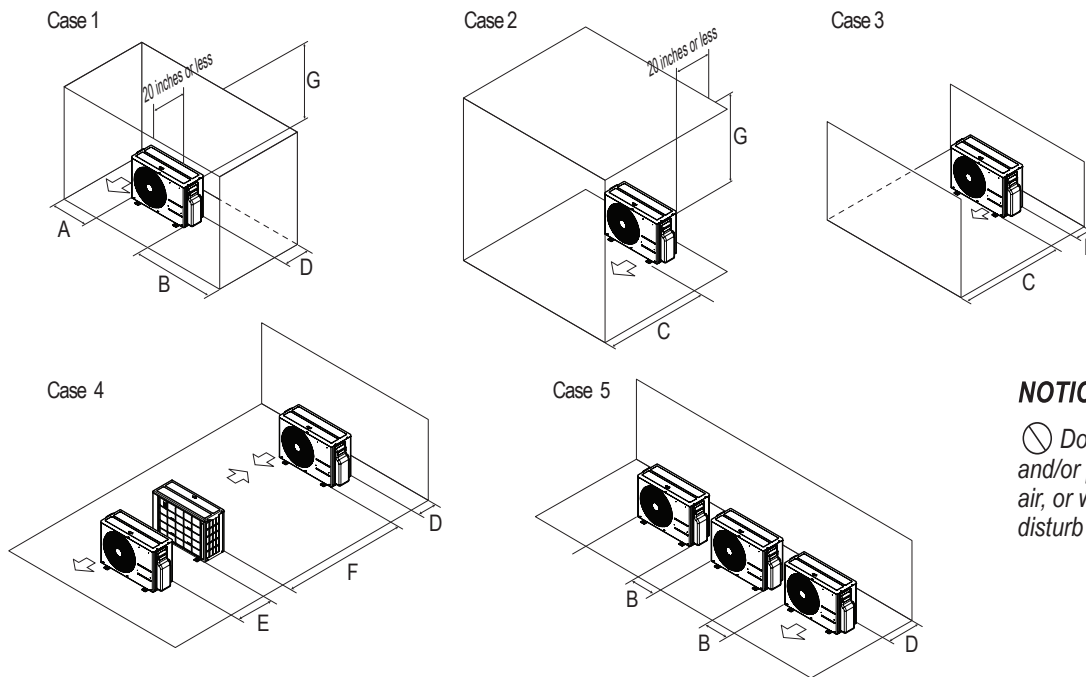

NOTICE

⚠ Do not place the unit where animals and/or plants will be in the path of the warm air, or where the warm air and/or noise will disturb neighbors.

Table 55: Single Fan Outdoor Unit Service Access and Allowable Clearances Diagram Legend.

Unit: Inch		A	B	C	D	E	F	G
Case 1	Standard	12	24	-	12	-	-	-
	Minimum	4	10	-	4	-	-	40
Case 2	Standard	-	-	20	-	-	-	-
	Minimum	-	-	14	-	-	-	40
Case 3	Standard	-	-	20	12	-	-	-
	Minimum	-	-	14	4	-	-	-
Case 4	Standard	-	-	-	12	24	-	-
	Minimum	-	-	-	4	8	79	-
Case 5	Standard	-	24	-	12	-	-	-
	Minimum	-	10	-	4	-	-	-

PLACEMENT / CLEARANCE CONSIDERATIONS

Outdoor Units

Minimum Clearance Requirements for Dual Fan Outdoor Units

Figures below and on the next page illustrate clearance requirements for various installation scenarios for dual fan outdoor units. Use the hot isle / cold isle approach when placing multiple units in close proximity to each other. Outdoor unit fans draw air from the back of the unit and discharges out the front. Place units back to back and face to face.

NOTICE

- Installation clearances must comply with local building codes.
- All figures not to scale.
- ⚠ Never place multiple units facing back to front or front to back as shown immediately below here or high and low system pressure problems will occur.

Figure 36: Improper Outdoor Unit Placement.

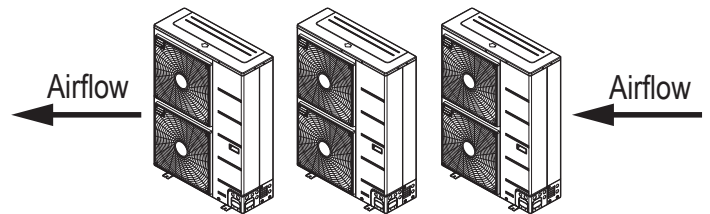
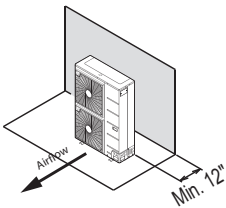
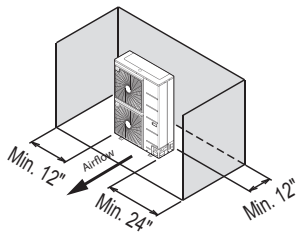

Figure 37: Proper Outdoor Unit Placement and Clearances When There Are Obstacles on the Suction Side.

Single Unit—High Rear Wall



Single Unit—High Rear Wall with High Side Walls



Single Unit—High Rear Wall with Building Overhang

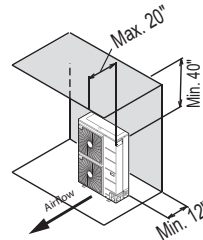

Single Unit—High Rear and Side Walls with Building Overhang

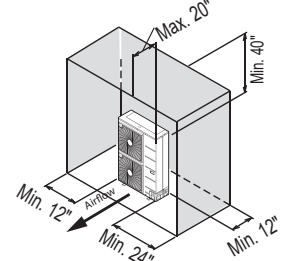

Side by Side—High Rear and Side Walls

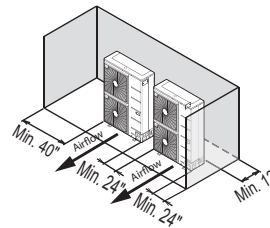

Side by Side—High Rear and Side Walls with Building Overhang

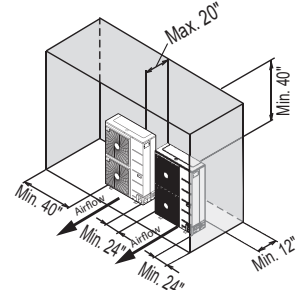
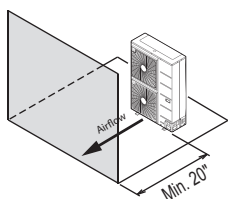
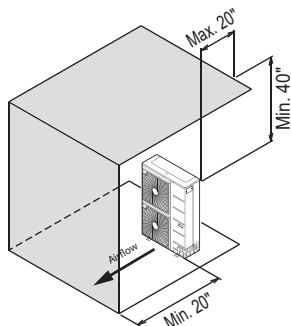

Figure 38: Proper Outdoor Unit Placement and Clearances When There Are Obstacles on the Discharge Side.

Single Unit—High Front Wall with No Side Walls



Single Unit—High Front Wall with Building Overhang and No Side Walls



Side by Side—High Front Wall with No Side Walls

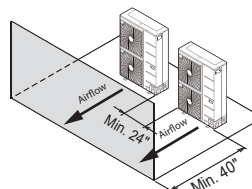

Side by Side—High Front Wall with Building Overhang and No Side or Rear Walls

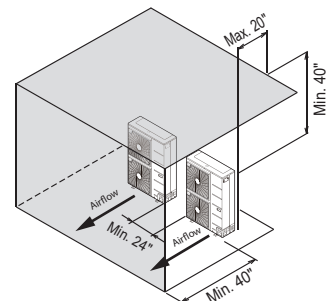

PLACEMENT / CLEARANCE CONSIDERATIONS

Outdoor Units

Minimum Clearance Requirements for Dual Fan Outdoor Units, Continued.

NOTICE

- Installation clearances must comply with local building codes.
- All figures not to scale.

Figure 39: Proper Outdoor Unit Placement and Clearances When There Are Obstacles on the Suction and the Discharge Sides.

When Obstacle Height of the Discharge Side is Higher than the Outdoor Unit.

Single Unit—High Rear and Front Walls with No Side Walls

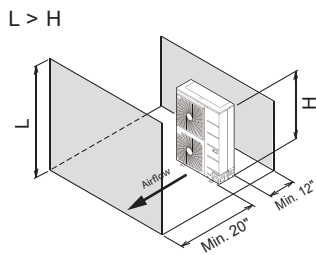

Single Unit—High Rear and Front Walls with Building Overhang

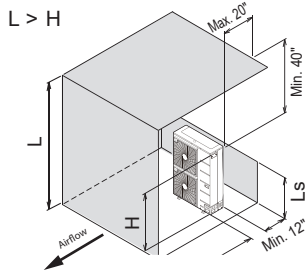

Table 56: H, A, and L Ratio.

	Ls	A (Inches)
$L \leq H$	$0 < Ls \leq 1/2 H$	30
	$1/2 H < Ls$	40
$H < L$	Set Stand as: $L \leq H$	

NOTICE

"L" must be lower than "H". If a stand is necessary, it must be made of solid material (not an open frame) to prevent the discharge air from short cycling.

Obstacle Height of Discharge Side Is Lower than the Outdoor Unit.

Single Unit—High Rear Wall and Low Front Wall with No Side Walls

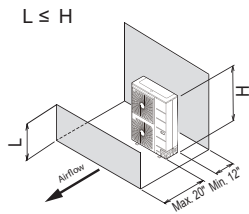

Single Unit—High Rear Wall and Low Front Wall with Building Overhang and No Side Walls

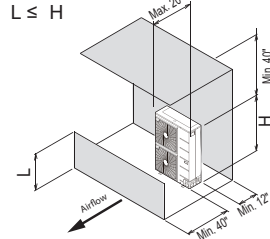

Side by Side—High Rear Wall and Low Front Wall with No Side Walls

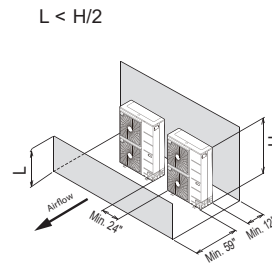

Side by Side—High Rear Wall and Low Front Wall with Building Overhang and No Side Walls

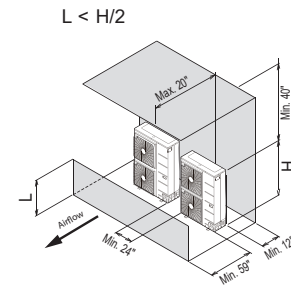

Series Installation

Side-by-side series installation.

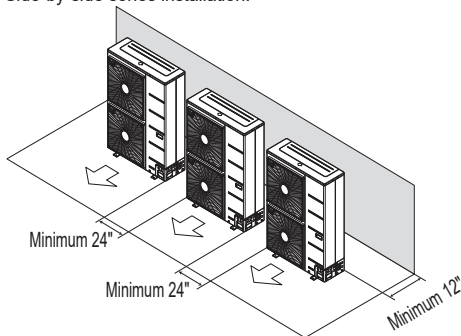

Series installation

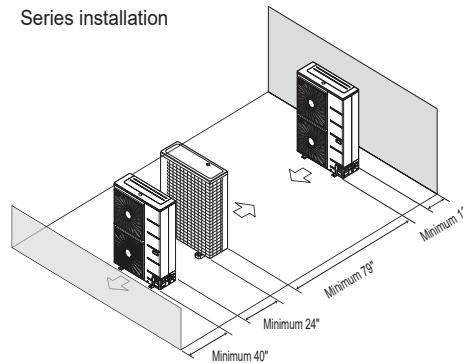

INSTALLING OUTDOOR UNITS INDOORS

Installing Outdoor Units Indoors

Single Zone outdoor units are engineered to be mounted outdoors and include technology designed to minimize the negative effects of winter weather's freezing rain, sleet, and snow. Some building projects, however, necessitate placing the HVAC outdoor units indoors:

- Lack of ground space.
- Lack of an appropriate outdoor location that meets system design requirements.
- When mounting on the roof is not an option due to a lack of roof space.
- Roof warranty will be voided if mechanical equipment is placed on the membrane.
- On retrofit projects, a former chiller / boiler / air handler equipment room, mechanical area, or penthouse already exists.
- To curtail the potential need for redundant zone heating devices such as wall-fin radiators or duct heaters.
- In extremely cold environments where there is a significant amount of run-time at temperatures well below freezing outside the outdoor unit ambient air temperature range published in this engineering manual.

Benefits of Installing Outdoor Units Indoors

- Shelters the outdoor unit from direct exposure to prevailing winds that decrease the heating capability of the outdoor unit.
- Protects equipment from freezing precipitation and / or potential ice build-up that could hinder unit operation.
- Maintains coil heat transfer efficiency by reducing the number of and shortening the cycle time for defrost operation.
- Easier maintenance and servicing during inclement weather.
- When mounted in a fully enclosed space, limiting the ambient air temperature will allow the Single Zone system designer to eliminate oversizing.
- The outdoor unit to compensate for loss of capacity at low ambient temperatures.
- Will also curtail the need to provide inefficient redundant zone heating devices such as wall-fin radiators and second-stage ancillary heating devices.

Design Considerations Include:

- Enclosure types and elements such as louvers (see next page), rain hoods, dampers and controls, heating methods and sizing of heating devices.
- Heating strategies.
- Duct design.
- Condensate handling.

General Guidelines

- Follow ASHRAE 62.1 design guidelines.
- Depending on the project / application, a roof over the outdoor units in combination with a wind break will be all that is necessary.
- Consider the potential for snow accumulation near louvers / roof openings. Outside air intakes and discharge ducts / louvers must be engineered to clear anticipated snow accumulation levels by at least one (1) foot.
- In situations where operation is anticipated at temperatures lower than the product's minimum operating temperature, ancillary heat must be provided to heat the outdoor unit coils to ensure continuous compressor operation and heating.

It may be necessary to use a field-fabricated air guide to prevent discharge air from short-cycling back to the coil inlet.

- Consider the direction of prevailing winds and opening placement. If possible, locate inlet openings upwind of discharge openings and other exhaust outlets.
- When inlet and outlet openings are placed on the same wall, minimum distance between the two openings must be approximately three (3) feet (minimum distance varies significantly with variations in outlet opening face velocity).
- If roof-mounted ventilation openings are used, strategically locate the inlet ventilation opening(s) upwind of the outlet opening(s).
- Discharge and supply ductwork must be designed to avoid weather related long periods of water entrainment.

INSTALLING OUTDOOR UNITS INDOORS

Provide a means to drain the condensate generated during heating mode and defrost cycle in addition to rainwater that infiltrates the inlet louver enclosed area.

- Install a field-provided drain pan under the outdoor units and provide a path to a nearby floor drain.
- If the ambient air temperature is expected to drop below 32°F in the enclosure, heat the bottom surface of the pan, drain line, and floor drain so that the condensate does not freeze before reaching the drain.

⚠ CAUTION

When deciding on a location to place the outdoor unit, be sure to choose an area where run-off from defrost will not accumulate and freeze on walkways, which will create unsafe conditions.

Allow for ventilation intake and exhaust air based on maximum outdoor unit fan capacity.

- Select the size, type and orientation of architectural louvers with adequate “net free area” face velocity to ensure the total external static pressure from the outdoor unit fan does not exceed design limitations (see specification data tables).
-  No obstructions must be placed in front of the louver that could hamper the free flow (throw) of air.
- Roof top openings and / or discharge and supply louvers must be equipped with screens to prevent bird and insect infiltration.

NOTICE

For louver recommendations, see below and on the next page.

As always, the best solution for each project balances acceptable heating performance (considering local weather conditions), capital costs, life cycle energy consumption, and limitations set forth by local building codes.

Louver Recommendations for Outdoor Unit Enclosure

1. Outdoor Unit Enclosure: Manual Door Open Type.
2. Louver Angle: No More Than 15° Horizontally.
3. Space Between Louvers: More than four (4) inches (Recommend).
4. Louver Shape: Wing or Plane Type.

NOTICE

- Open Rate and Inlet must be taken into consideration when designing the louvered outdoor unit enclosure.
-  Do not use “S” type louvers.

NOTICE

If the Louver Open Rate is Too Small

1. Noise can occur because of the increased air velocity passing through the louver blade.
2. Noise can occur from louver blade vibrations.
3. A drop in outdoor unit fan performance (excess static pressure can cause a drop in outdoor unit performance and heat exchanger efficiency).
4. If the louver open rate is too small or there is insufficient air flow exchange, the air conditioner might stop operating.

Figure 40: Louver Recommendations.

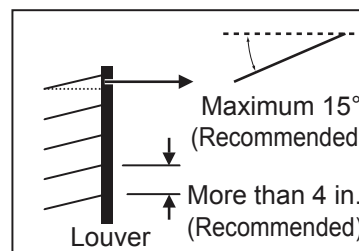
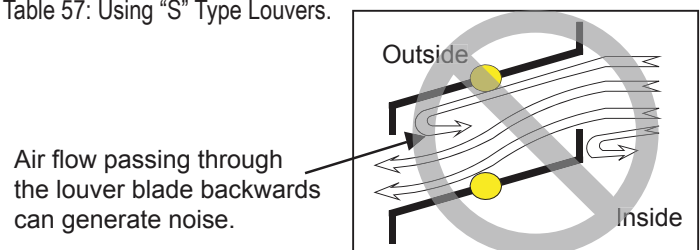

Table 57: Using “S” Type Louvers.



INSTALLING OUTDOOR UNITS INDOORS

Open Rate by Louver Radian

Figure 41: Open Rate by Louver Radian Formula.

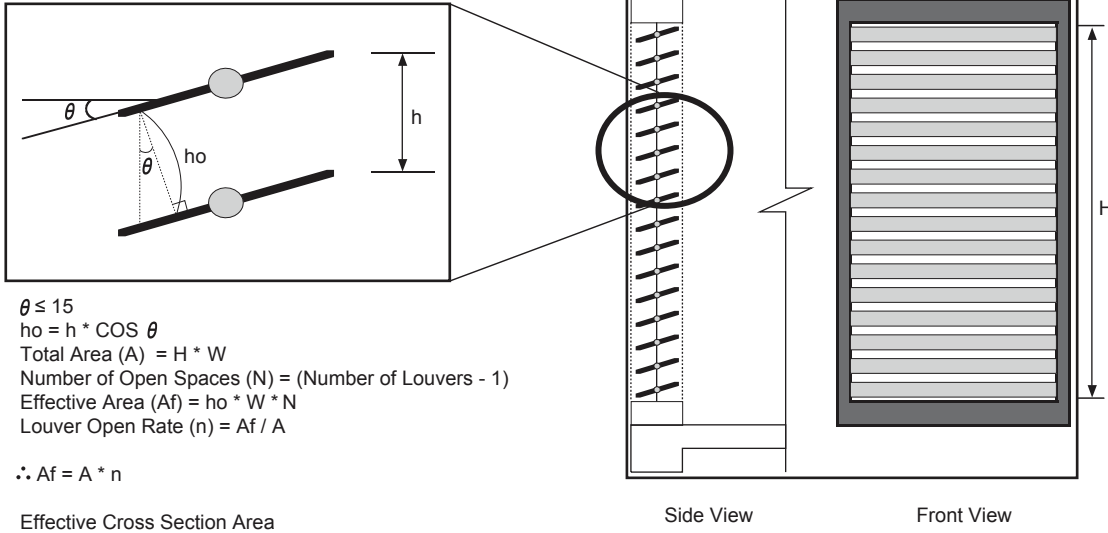

Confirming Air Flow Rate / Total Opening Rate

- Example: KUSXA481A (For illustrative purposes only).
- Discharge Airflow Rate: 3,884 ft.³/min.
- Velocity of Outlet Air: 13.8 ft./s
- Velocity of Inlet Air: 7.1 ft./s
- Open Rate = 80% or More

$$\text{Open Rate} = \frac{\text{Effective Face Area (Af)}}{\text{Total Face Area (A)}}$$
- Inlet airflow must match or exceed discharge airflow.
- Separate inlet airflow from discharge airflow to prevent recirculation.

Figure 42: Example of Installing Outdoor Unit Indoors.

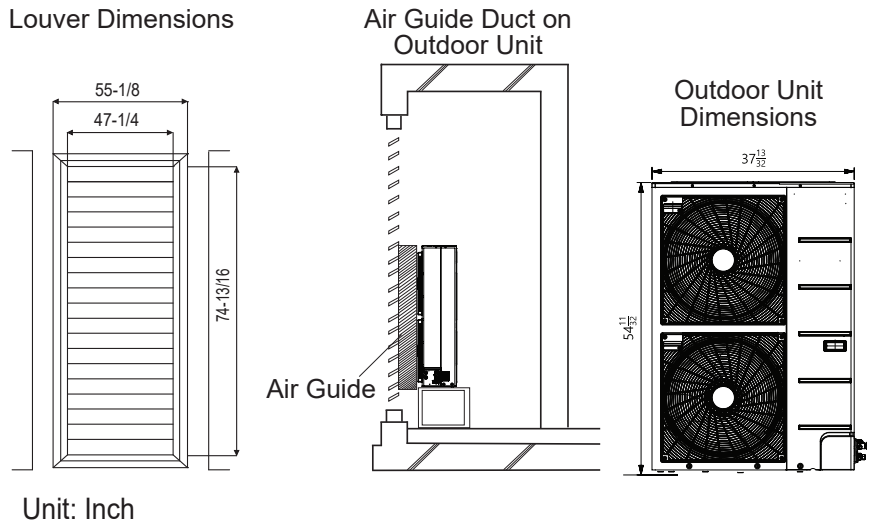

Formula

- Total Louver Dimension (Excluding Frame) (A) = 3.9 feet x 6.2 feet = 24.2 ft.²
- Area Blocked by Outdoor Unit (Discharge) (B) = 3.1 feet x 4.5 feet = 13.95 ft.²
- Inlet Louver Dimension (A - B) = 10.25 ft.²
- Equivalent Inlet Dimension (Open Rate 80%) = 10.25 ft.² x 0.8 = 8.2 ft.²
- Equivalent Inlet Airflow = 8.2 ft.² x 7.1 ft./s x 60 sec./min. = 3,493 ft.³/min.
- Equivalent Inlet Airflow / Discharge Airflow = 3,493 ft.³/min. / 3,884 ft.³/min. = 89.9% (Within Allowable Limits)

REFRIGERANT PIPING DESIGN

Refrigerant Flow Diagrams on page 88

Connection Limitations and System Layout on page 93

Additional Refrigerant Charge on page 94

Refrigerant Piping System Engineering on page 95

REFRIGERANT FLOW DIAGRAMS

KUSXB091A, KUSXB121A Outdoor Units

NOTICE

Various tools are available to assist in properly designing LG R32 split systems. Refer to the "R32 Application Guide"; the "Simple Calculator for Capacity, Refrigerant Charge and ESP"; the "LG Air Conditioner Technical Solutions" (LATS) software program; and the local LG Sales Representative.

Figure 43: KUSXB091A, KUSXB121A Outdoor Unit Refrigerant Flow Diagram.

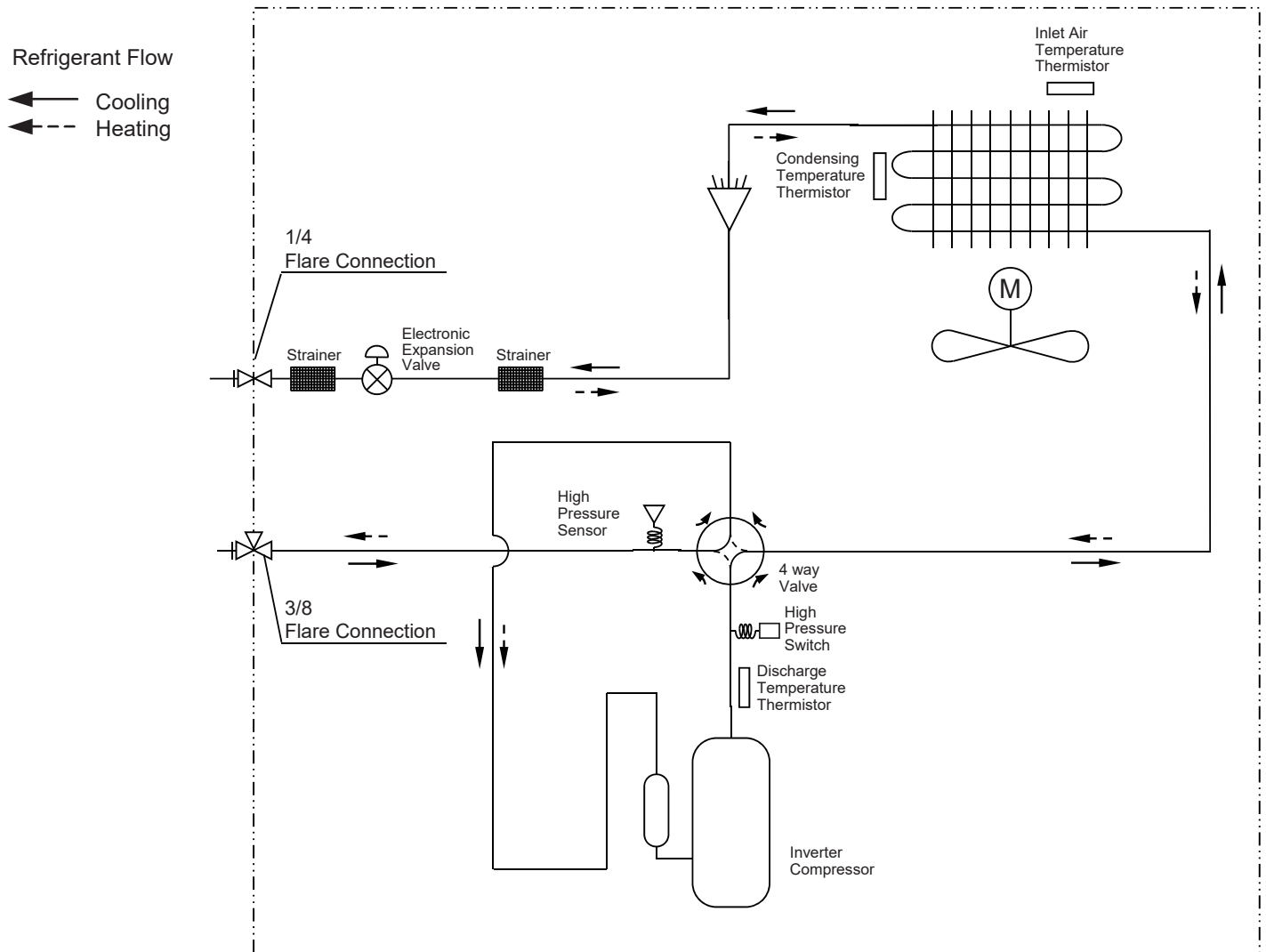

Table 58: KUSXB091A, KUSXB121A Outdoor Unit Thermistor Details.

Description	PCB Connector
Discharge Pipe Temperature Thermistor	CN6_BK
Air Temperature Thermistor	CN8_YL
Condenser Middle Pipe Temperature Thermistor	CN4_BR
Pressure Sensor	CN9_RD
Pressure Switch	CN_PRESS(HW)

REFRIGERANT FLOW DIAGRAMS

KUSXB181A, KUSXB241A, KUSXB301A, KUSXB361A, KUSXB421A, KUSXB481A

Outdoor Units

NOTICE

Various tools are available to assist in properly designing LG R32 split systems. Refer to the "R32 Application Guide"; the "Simple Calculator for Capacity, Refrigerant Charge and ESP"; the "LG Air Conditioner Technical Solutions" (LATS) software program; and the local LG Sales Representative.

Figure 44: KUSXB181A, KUSXB241A, KUSXB301A, KUSXB361A, KUSXB421A, KUSXB481A Outdoor Unit Refrigerant Flow Diagram.

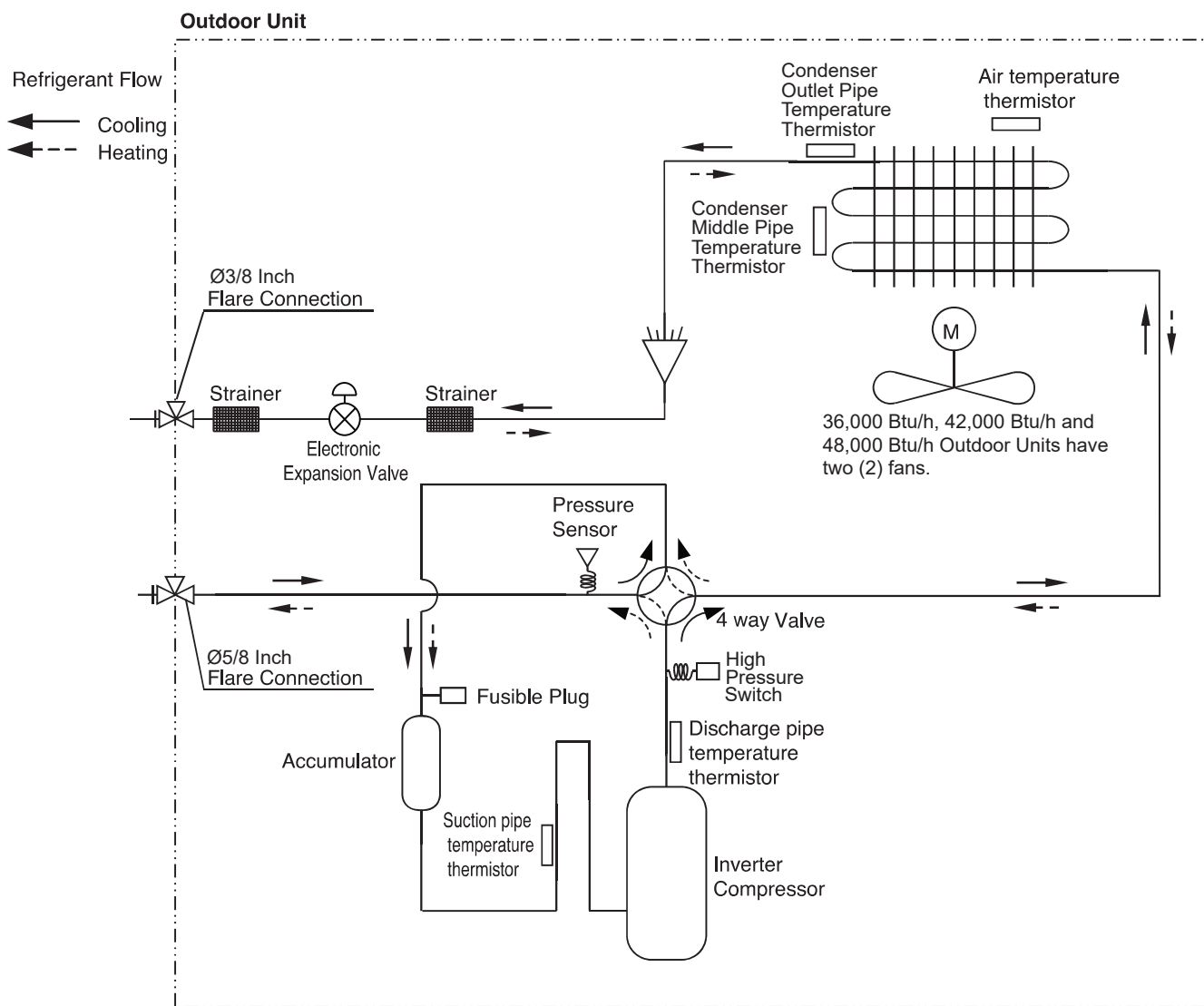

Refrigerant Piping Design

Table 59: KUSXB181A, KUSXB241A, KUSXB301A, KUSXB361A, KUSXB421A, KUSXB481A Outdoor Unit Thermistor Details.

Description	PCB Connector
Discharge Pipe Temperature Thermistor	CN6_BK
Suction Pipe Temperature Thermistor	CN5_GN
Condenser Outlet Pipe Temperature Thermistor	CN7_VI
Air Temperature Thermistor	CN8_YL
Condenser Middle Pipe Temperature Thermistor	CN4_BR
Pressure Sensor	CN9_RD
Pressure Switch	CN_PRESS_SW

REFRIGERANT FLOW DIAGRAMS

KNUDB091A, KNUDB121A Indoor Units

NOTICE

Various tools are available to assist in properly designing LG R32 split systems. Refer to the "R32 Application Guide"; the "Simple Calculator for Capacity, Refrigerant Charge and ESP"; the "LG Air Conditioner Technical Solutions" (LATS) software program; and the local LG Sales Representative.

Figure 45: KNUDB091A, KNUDB121A Indoor Unit Refrigerant Flow Diagram.

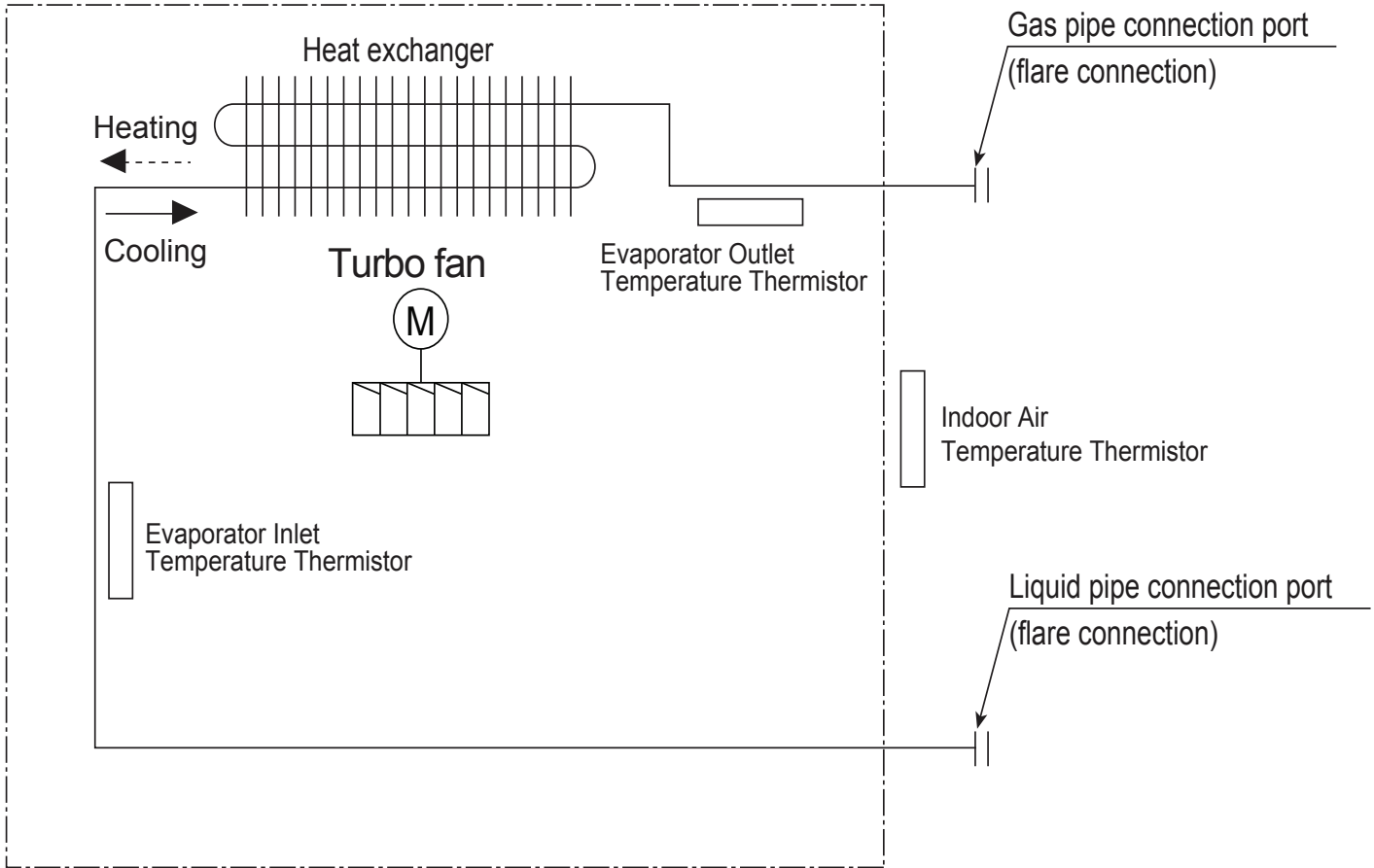

Table 60: KNUDB091A, KNUDB121A Indoor Unit Thermistor Details.

Description (Based on Cooling Mode)	PCB Connector
Indoor Air Temperature Thermistor	CN_ROOM
Evaporator Inlet Temperature Thermistor	CN_PIPE_IN
Evaporator Outlet Temperature Thermistor	CN_PIPE_OUT

Table 61: KNUDB091A, KNUDB121A Indoor Unit Refrigerant Piping and Connection Sizes.

Model No.	Piping Size		Connection Port Size	
	Liquid (inch)	Vapor (inch)	Liquid (inch)	Vapor (inch)
KNUDB091A	1/4	3/8	1/4	3/8
KNUDB121A	1/4	3/8	1/4	3/8

REFRIGERANT FLOW DIAGRAMS

KNUDB181A Indoor Units

NOTICE

Various tools are available to assist in properly designing LG R32 split systems. Refer to the "R32 Application Guide"; the "Simple Calculator for Capacity, Refrigerant Charge and ESP"; the "LG Air Conditioner Technical Solutions" (LATS) software program; and the local LG Sales Representative.

Figure 47: KNUDB181A Indoor Unit Refrigerant Flow Diagram.

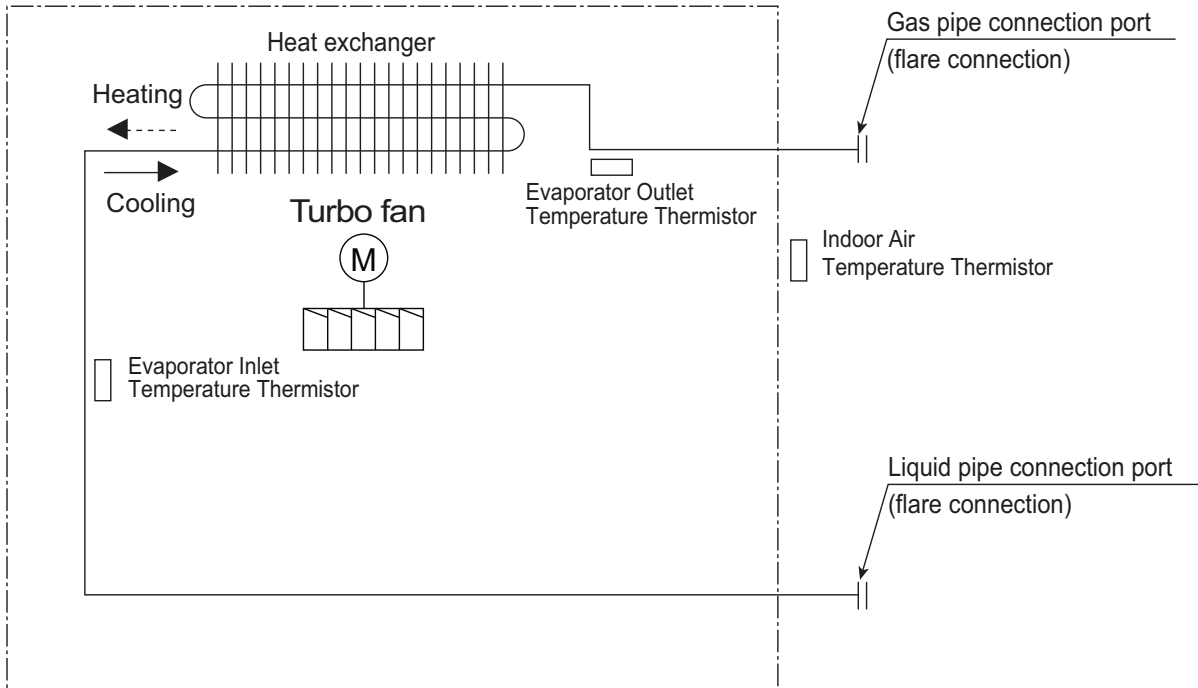

Table 62: KNUDB181A Indoor Unit Thermistor Details.

Description (Based on Cooling Mode)	PCB Connector
Indoor Air Temperature Thermistor	CN_ROOM
Evaporator Inlet Temperature Thermistor	CN_PIPE_IN
Evaporator Outlet Temperature Thermistor	CN_PIPE_OUT

Table 63: KNUDB181A Indoor Unit Refrigerant Piping and Connection Sizes.

Model No.	Piping Size		Connection Port Size	
	Liquid (inch)	Vapor (inch)	Liquid (inch)	Vapor (inch)
KNUDB181A*	3/8	5/8	1/4	1/2

Table 64: KNUDB181A Connection Socket Dimensions.

Model No.	Vapor (inch)	Liquid (inch)
KNUDB181A*	Ø1/2 – Ø5/8	Ø1/4 – Ø3/8

*Refer to the image at right for KNUDB181A socket connections.

Figure 46: KNUDB181A Refrigerant Pipe Connections.

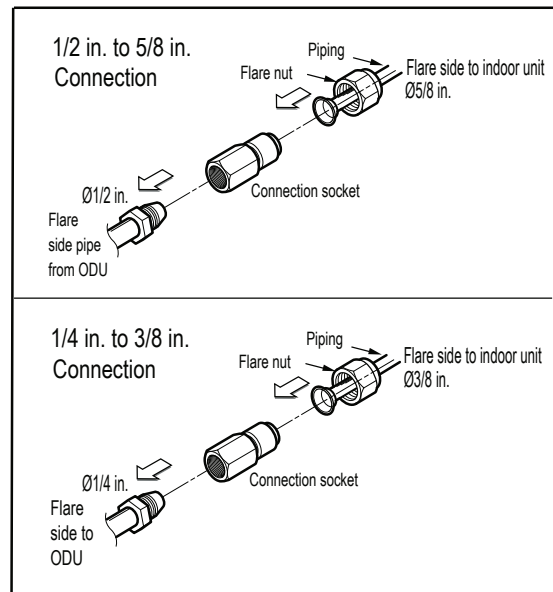

REFRIGERANT FLOW DIAGRAMS

KNSCB241A, KNSCB301A, KNSCB361A, KNSCB421A, KNSCB481A Indoor Units

NOTICE

Various tools are available to assist in properly designing LG R32 split systems. Refer to the "R32 Application Guide"; the "Simple Calculator for Capacity, Refrigerant Charge and ESP"; the "LG Air Conditioner Technical Solutions" (LATS) software program; and the local LG Sales Representative.

Figure 48: KNSCB241A, KNSCB301A, KNSCB361A, KNSCB421A, KNSCB481A Refrigerant Flow Diagram.

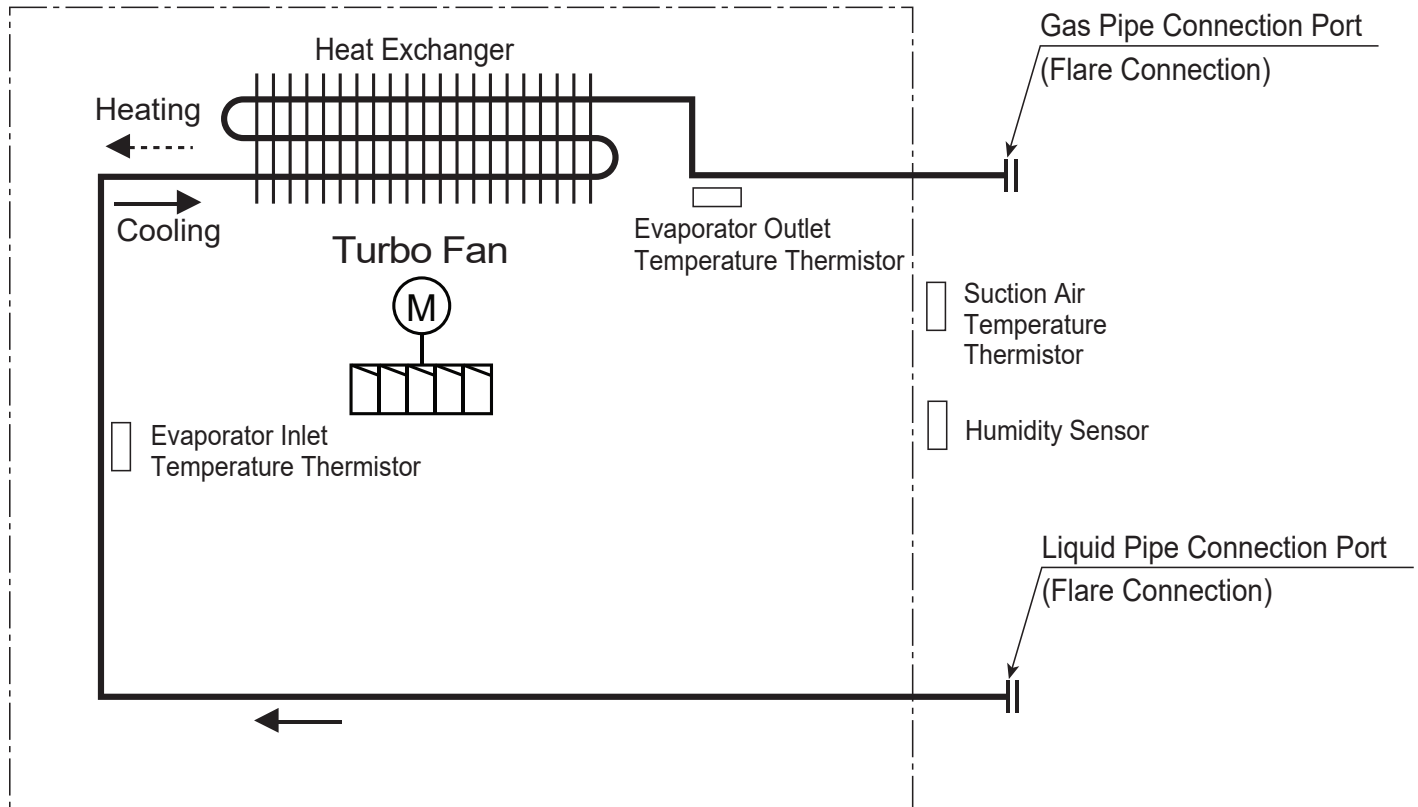

Table 65: KNSCB241A, KNSCB301A, KNSCB361A, KNSCB421A, KNSCB481A Indoor Unit Thermistor Details.

Description (Based on Cooling Mode)	PCB Connector
Suction Air Temperature Thermistor	CN_ROOM
Evaporator Inlet Temperature Thermistor	CN_PIPE_IN
Evaporator Outlet Temperature Thermistor	CN_PIPE_OUT
Humidity Sensor	CN_ROOM_HUMID

Table 66: KNSCB241A, KNSCB301A, KNSCB361A, KNSCB421A, KNSCB481A Indoor Unit Refrigerant Piping and Connection Sizes.

Model No.	Piping Size		Connection Port Size	
	Liquid (inch)	Vapor (inch)	Liquid (inch)	Vapor (inch)
KNSCB241A	3/8	5/8	3/8	5/8
KNSCB301A	3/8	5/8	3/8	5/8
KNSCB361A	3/8	5/8	3/8	5/8
KUSXB421A	3/8	5/8	3/8	5/8

CONNECTION LIMITATIONS / SYSTEM LAYOUT

NOTICE

Various tools are available to assist in properly designing LG R32 split systems. Refer to the "R32 Application Guide"; the "Simple Calculator for Capacity, Refrigerant Charge and ESP"; the "LG Air Conditioner Technical Solutions" (LATS) software program; and the local LG Sales Representative.

Connection Limitations

Single-zone systems consist of one outdoor unit and one indoor unit. One of the most critical elements of a single zone system is the refrigerant piping. If the connection piping is not within allowable limits, there will be reliability, performance, noise, and vibration issues. The table below lists pipe length limits that must be followed in the design of a Single Zone Standard Cassette refrigerant pipe system. Refer to the figure for maximum length and elevation of piping.

NOTICE

Depending on system and proposed / installed pipe length, it may be required to calculate maximum refrigerant charge to determine if the system complies with applicable regulations / standards. For residential applications, a refrigerant charge less than 4.1 lbs. complies with ASHRAE 15.2 and does not require additional calculation/consideration of maximum refrigerant charge for release in a space.

Table 67: R32 Single-Zone Four-Way Cassette Refrigerant Piping System Limitations.

System Model No.		KSUDB091A, KSUDB121A	KSUDB181A	KSSCB241A, KSSCB301A	KSSCB361A, KSSCB421A, KSSCB481A
Liquid Piping (in.)	Connection / Pipe Size	1/4 / 1/4	1/4 / 3/8	3/8 / 3/8	3/8 / 3/8
Vapor Piping (in.)	Connection / Pipe Size	3/8 / 3/8	1/2 / 5/8	5/8 / 5/8	5/8 / 5/8
Pipe Length (ELF = Equivalent Length of Pipe)	Standard length (no add'l refrigerant)	24.6 feet	24.6 feet	24.6 feet	24.6 feet
	Longest total equivalent piping length	65.6 feet	164 feet	164 feet	246 feet
	Shortest total equivalent piping length	16.4	16.4	16.4	16.4
	Distance between fittings and indoor or outdoor units	≥20 inches	≥20 inches	≥20 inches	≥20 inches
Elevation (All Elevation Limitations are Measured in Actual Feet)	If outdoor unit is above indoor unit	49.2 feet	98.4 feet	98.4 feet	98.4 feet
	If outdoor unit is below indoor unit	49.2 feet	98.4 feet	98.4 feet	98.4 feet
Additional Refrigerant Needed (oz. /ft.)		0.22	0.38	0.38	0.43

System Layout

Figure 49: Typical KSUDB091A and KSUDB121A System Layout.

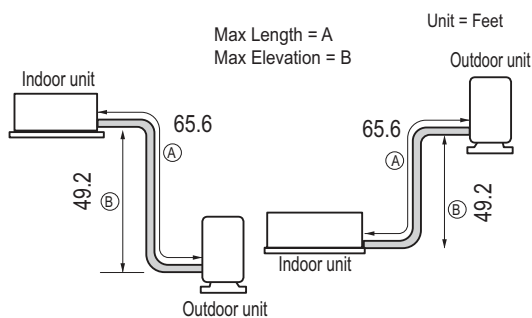

Figure 50: Typical KSUDB181A, KSSCB241A, and KSSCB301A System Layout.

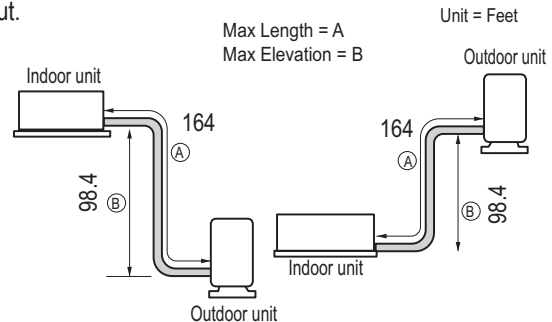
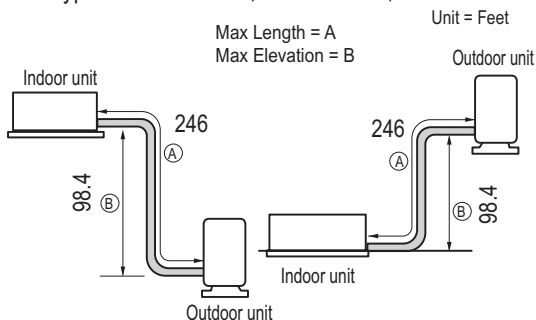

Figure 51: Typical KSSCB361A, KSSCB421A, KSSCB481A System Layout.



ADDITIONAL REFRIGERANT CHARGE

NOTICE

Various tools are available to assist in properly designing LG R32 split systems. Refer to the "R32 Application Guide"; the "Simple Calculator for Capacity, Refrigerant Charge and ESP"; the "LG Air Conditioner Technical Solutions" (LATS) software program; and the local LG Sales Representative.

Additional Refrigerant Charge

Each outdoor unit is factory charged (nameplate charge) for the evaporator as well as having a standard foot line (for each single zone system; listed in the specification tables). Any time a line set is used longer than the standard foot line set length for the single zone system, the refrigerant charge has to be adjusted.

The charge must be adjusted on the ounces of R32 (listed in the specification tables) per foot based on how many feet of piping are added. The factory charge accommodates pipe lengths up to the standard (no additional refrigerant) length without requiring refrigerant removal. See table below for information on the additional refrigerant charges necessary for longer piping lengths. Refer to the previous page for maximum piping length and additional charge amount per additional foot of pipe length.

Table 68: R32 Single Zone Four-Way Cassette Additional Refrigerant by Piping Length (oz.)

System Model No.	Add'l Charge (oz./ft.)	Std. Piping Length (no add'l refriger., ft.)	Refrigerant Piping Length (feet)																
			16.4	24.6	32.8	41	49.2	65.6	82	98.4	114.8	131.2	147.6	164	180.4	196.8	213.2	229.6	246
KSUDB091A (9k)	0.22	24.6	0	0	1.8	3.6	5.4	9.0	-	-	-	-	-	-	-	-	-	-	-
KSUDB121A (12k)	0.22	24.6	0	0	1.8	3.6	5.4	9.0	-	-	-	-	-	-	-	-	-	-	-
KSUDB181A (18k)	0.38	24.6	0	0	3.1	6.2	9.3	15.6	21.8	28.0	34.3	40.5	46.7	53.0	-	-	-	-	-
KSSCB241A (24k)	0.38	24.6	0	0	3.1	6.2	9.3	15.6	21.8	28.0	34.3	40.5	46.7	53.0	-	-	-	-	-
KSSCB301A (30k)	0.38	24.6	0	0	3.1	6.2	9.3	15.6	21.8	28.0	34.3	40.5	46.7	53.0	-	-	-	-	-
KSSCB361A (36k)	0.43	24.6	0	0	3.5	7.1	10.6	17.6	24.7	31.7	38.8	45.8	52.9	59.9	67.0	74.0	81.1	88.2	95.2
KSSCB421A (42k)	0.43	24.6	0	0	3.5	7.1	10.6	17.6	24.7	31.7	38.8	45.8	52.9	59.9	67.0	74.0	81.1	88.2	95.2
KSSCB481A (48k)	0.43	24.6	0	0	3.5	7.1	10.6	17.6	24.7	31.7	38.8	45.8	52.9	59.9	67.0	74.0	81.1	88.2	95.2

- Values are in ounces (oz.).
- Capacity is based on standard length; maximum allowance length is based on reliability.
- Equivalent Pipe Length = Actual Pipe Length + Number of Bends x 0.3.
- Calculation: X oz. = [(Refrigerant Piping Length] - [(Chargeless Length)] x Additional Refrigerant

Example:

A 50 foot line set is used: Additional 24.6 feet x 0.38 per foot = Add 9.6 of refrigerant.

NOTICE

If the unit charge is unknown, reclaim, evacuate, and weigh in the correct charge using the unit nameplate (capacity) charge adjusting for line sets longer than 246 feet. This will prevent any interruptions to unit operation and possible damage.

REFRIGERANT PIPING SYSTEM ENGINEERING

NOTICE

Various tools are available to assist in properly designing LG R32 split systems. Refer to the “R32 Application Guide”; the “Simple Calculator for Capacity, Refrigerant Charge and ESP”; the “LG Air Conditioner Technical Solutions” (LATS) software program; and the local LG Sales Representative.

Selecting Field-Supplied Copper Piping

NOTICE

Always follow local codes when selecting and installing copper pipe and piping system components.

Approved piping for use with LG Single Zone products will be marked “R32 RATED” along the length of the pipe. Piping wall thickness must meet local code requirements and be approved for a maximum operating pressure of 626 psi. When bending piping, try to keep the number of bends to a minimum, and use the largest radii possible to reduce the equivalent length of installed piping; also, bending radii greater than ten (10) piping diameters can minimize pressure drop. Be sure no traps or sags are present.

For Single Zone Systems

LG prefers the use of ACR copper piping rated at the system working pressure was used.

NOTICE

Always properly support the piping as per the instructions on page 99.

Table 69: ACR Rated Copper Tubing Material.

Type	Seamless Phosphorous Deoxidized
Class	UNS C12200 DHP
Straight Lengths	H58 Temper
Coils	O60 Temper

Table 70: Piping Tube Thicknesses.

OD (in.)	1/4	3/8	1/2	5/8	3/4	7/8	1-1/8	1-3/8
Material	Rigid or Soft ACR Rated for R32				Rigid or Soft ACR Rated for R32			
Min. Bend Radius (in.)	0.563	0.9375	1.5	2.25	3.0	3.0	3.5	4.0
Min. Wall Thickness (in.)	0.030	0.030	0.030	0.030	0.030	0.030	0.030	0.040

Table 71: ACR Copper Tubing Dimensions and Physical Characteristics¹⁻³.

Nominal Pipe Outside Diameter (in.)	Actual Outside Diameter (in.)	Drawn Tempered (Hard)			Annealed Temper (Soft)		
		Nominal Wall Thickness (in.)	Weight (lb. / ft.)	Cubic ft. per Linear ft.	Nominal Wall Thickness (in.)	Weight (lb. / ft.)	Cubic ft. per Linear ft.
1/4	0.250	-	-	-	0.030	0.0804	0.00020
3/8	0.375	0.030	0.126	0.00054	0.032	0.134	0.00053
1/2	0.500	0.035	0.198	0.00101	0.032	0.182	0.00103
5/8	0.625	0.040	0.285	0.00162	0.035	0.251	0.00168
3/4	0.750	0.042	0.362	0.00242	0.035	0.305	0.00252
7/8	0.875	0.045	0.455	0.00336	0.045	0.455	0.00336
1-1/8	1.125	0.050	0.655	0.00573	0.050	0.655	0.00573
1-3/8	1.375	0.055	0.884	0.00875	0.055	0.884	0.00875

¹All dimensions provided are in accordance with ASTM B 280 – Standard.

²Design pressure = 626 psig.

³The Copper Tube Handbook: Industry Standard Guide for the Design and Installation of Copper Piping Systems; Copper Development Association Inc., Copper Alliance; https://www.copper.org/publications/pub_list/pdf/copper_tube_handbook.pdf.

NOTICE

- Commercially available piping often contains dust and other materials. Always blow it clean with a dry inert gas.
- Prevent dust, water or other contaminants from entering the piping during installation.

REFRIGERANT PIPING SYSTEM ENGINEERING

NOTICE

Various tools are available to assist in properly designing LG R32 split systems. Refer to the “R32 Application Guide”; the “Simple Calculator for Capacity, Refrigerant Charge and ESP”; the “LG Air Conditioner Technical Solutions” (LATS) software program; and the local LG Sales Representative.

Copper Expansion and Contraction

Under normal operating conditions, the vapor pipe temperature of a Single Zone System can vary as much as 280°F. With this large variance in pipe temperature, the designer must consider pipe expansion and contraction to avoid pipe and fitting fatigue failures.

Refrigerant pipe along with the insulation jacket form a cohesive unit that expands and contracts together. During system operation, thermal heat transfer occurs between the pipe and the surrounding insulation.

If the pipe is mounted in free air space, no natural restriction to movement is present if mounting clamps are properly spaced and installed. In extreme cases, the restrictive force of surface friction between insulating jackets could become so great that natural expansion ceases and the pipe is “fixed” in place. In this situation, opposing force caused by change in refrigerant fluid / vapor temperature can lead to pipe/fitting stress failure.

The refrigerant pipe support system must be engineered to allow free expansion to occur. When a segment of pipe is mounted between two fixed points, provisions must be provided to allow pipe expansion to naturally occur. The most common method is the inclusion of expansion Loop or U-bends. Each segment of pipe has a natural fixed point where no movement occurs. This fixed point is located at the center point of the segment assuming the entire pipe is insulated in a similar fashion. The natural fixed point of the pipe segment is typically where the expansion Loop or U-bend must be.

Linear pipe expansion can be calculated using the following formula:

$$LE = C \times L \times (T_r - T_a) \times 12$$

LE	=	Anticipated linear tubing expansion (in.)
C	=	Constant (For copper = 9.2×10^{-6} in./in.°F)
L	=	Length of pipe (ft.)
T_r	=	Refrigerant pipe temperature (°F)
T_a	=	Ambient air temperature (°F)
12	=	Inches to feet conversion (12 in./ft.)

See table on next page for precalculated anticipated expansion for various pipe sizes and lengths of refrigerant tubing.

To find the anticipated expansion value:

1. From the table on the next page, find the row corresponding with the actual feet of the straight pipe segment.
2. Estimate the minimum and maximum temperature of the pipe.
3. In the column showing the minimum pipe temperature, look up the anticipated expansion distance corresponding to the segment length. Do the same for the maximum pipe temperature.
4. Calculate the difference in the two expansion distance values. The result will be the change in pipe length.

1. From the “Linear Thermal Expansion of Copper Tubing in Inches” Table on the next page, find the row corresponding with the actual length of the straight pipe segment.
2. Estimate the minimum and maximum temperature of the pipe. In the column showing the minimum pipe temperature, look up the anticipated expansion distance. Do the same for the maximum pipe temperature.
3. Calculate the difference in the two expansion distance values. The result will be the anticipated change in pipe length.

General Example:

A system is installed and the design shows that there is a 100 foot straight segment of tubing between an indoor unit and the outdoor unit. In heating, this pipe transports hot gas vapor to the indoor units at 120°F. In cooling, the same tube is a suction line returning refrigerant vapor to the outdoor unit at 40°F. Look up the copper tubing expansion at each temperature and calculate the difference.

Vapor Line

Transporting Hot Vapor: 100 ft. pipe at 120°F = 1.40 in.

Transporting Suction Vapor: 100 ft. pipe at 40°F = 0.40 in.

Anticipated Change in Length: 1.40 in. – 0.40 in. = 1.00 in.

Liquid Line

The liquid temperature remains relatively the same temperature; only the direction of flow will reverse. Therefore, no significant change in length of the liquid line is anticipated.

When creating an expansion joint, the joint height must be a minimum of two times the joint width. Although different types of expansion arrangements are available, the data for correctly sizing an Expansion Loop is provided in the “Radii of Coiled Expansion Loops and Developed Lengths of Expansion Offsets” Table on the next page. Use soft copper with long radius bends on longer runs or long radius elbows for shorter pipe segments. Using the anticipated linear expansion (LE) distance calculated, look up the Expansion Loop or U-bend minimum design dimensions. If other types of expansion joints are chosen, design per ASTM B-88 Standards.

REFRIGERANT PIPING SYSTEM ENGINEERING

NOTICE

Various tools are available to assist in properly designing LG R32 split systems. Refer to the "R32 Application Guide"; the "Simple Calculator for Capacity, Refrigerant Charge and ESP"; the "LG Air Conditioner Technical Solutions" (LATS) software program; and the local LG Sales Representative.

Table 72: Linear Thermal Expansion of Copper Tubing in Inches.

Pipe Length ¹	Fluid Temperature °F																			
	35°	40°	45°	50°	55°	60°	65°	70°	75°	80°	85°	90°	95°	100°	105°	110°	115°	120°	125°	130°
10	0.04	0.04	0.05	0.06	0.06	0.07	0.08	0.08	0.09	0.09	0.10	0.10	0.11	0.11	0.11	0.12	0.13	0.14	0.15	0.15
20	0.08	0.08	0.10	0.12	0.13	0.14	0.15	0.16	0.17	0.18	0.19	0.20	0.21	0.22	0.22	0.23	0.26	0.28	0.29	0.30
30	0.12	0.12	0.15	0.18	0.20	0.21	0.23	0.24	0.26	0.27	0.29	0.30	0.32	0.33	0.32	0.35	0.39	0.42	0.44	0.45
40	0.16	0.16	0.20	0.24	0.26	0.28	0.30	0.32	0.34	0.36	0.38	0.40	0.42	0.44	0.43	0.46	0.52	0.56	0.58	0.60
50	0.20	0.20	0.25	0.30	0.33	0.35	0.38	0.40	0.43	0.45	0.48	0.50	0.53	0.55	0.54	0.58	0.65	0.70	0.73	0.75
60	0.24	0.24	0.30	0.36	0.39	0.42	0.45	0.48	0.51	0.54	0.57	0.60	0.63	0.66	0.65	0.69	0.78	0.84	0.87	0.90
70	0.28	0.28	0.35	0.42	0.46	0.49	0.53	0.56	0.60	0.63	0.67	0.70	0.74	0.77	0.76	0.81	0.91	0.98	1.02	1.05
80	0.32	0.32	0.40	0.48	0.52	0.56	0.60	0.64	0.68	0.72	0.76	0.80	0.84	0.88	0.86	0.92	1.04	1.12	1.16	1.20
90	0.36	0.36	0.45	0.54	0.59	0.63	0.68	0.72	0.77	0.81	0.86	0.90	0.95	0.99	0.97	1.04	1.17	1.26	1.31	1.35
100	0.40	0.40	0.50	0.60	0.65	0.70	0.75	0.80	0.85	0.90	0.95	1.00	1.05	1.10	1.08	1.15	1.30	1.40	1.45	1.50
120	0.48	0.48	0.60	0.72	0.78	0.84	0.90	0.96	1.02	1.08	1.14	1.20	1.26	1.32	1.30	1.38	1.56	1.68	1.74	1.80
140	0.56	0.56	0.70	0.84	0.91	0.98	1.05	1.12	1.19	1.26	1.33	1.40	1.47	1.54	1.51	1.61	1.82	1.96	2.03	2.10
160	0.64	0.64	0.80	0.96	1.04	1.12	1.20	1.28	1.36	1.44	1.52	1.60	1.68	1.76	1.73	1.84	2.08	2.24	2.32	2.40
180	0.72	0.72	0.90	1.08	1.17	1.26	1.35	1.44	1.53	1.62	1.71	1.80	1.89	1.98	1.94	2.07	2.34	2.52	2.61	2.70

¹Pipe length baseline temperature = 0°F. "Expansion of Carbon, Copper and Stainless Steel Pipe," *The Engineers' Toolbox*, www.engineeringtoolbox.com.

Figure 52: Coiled Expansion Loops and Offsets (Plan View).

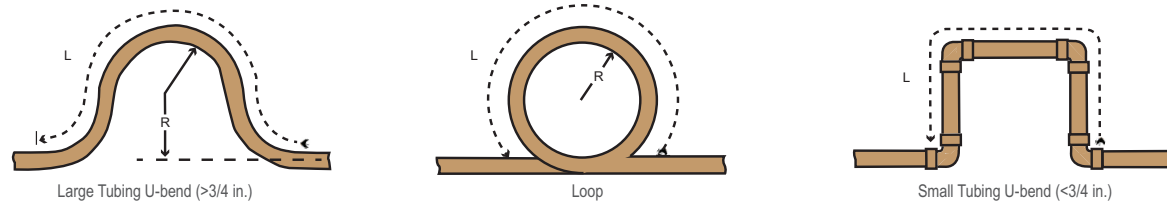

NOTICE

All expansion loops and offsets must be installed in the horizontal plane to prevent the possibility of trapping oil. Loops and offsets in vertical risers must also be installed in a horizontal plane.

Table 73: Radii of Coiled Expansion Loops and Developed Lengths of Expansion Offsets. (See *The Copper Tube Handbook: Industry Standard Guide for the Design and Installation of Copper Piping Systems*; Copper Development Association Inc., Copper Alliance; https://www.copper.org/publications/pub_list/pdf/copper_tube_handbook.pdf for additional information.)

Anticipated Linear Expansion (LE) (inches)		Nominal Tube Size (OD) inches			
		1/4	3/8	1/2	3/4
1/2	R ¹	6	7	8	9
	L ²	38	44	50	59
1	R ¹	9	10	11	13
	L ²	54	63	70	83
1-1/2	R ¹	11	12	14	16
	L ²	66	77	86	101
2	R ¹	12	14	16	19
	L ²	77	89	99	117
2-1/2	R ¹	14	16	18	21
	L ²	86	99	111	131
3	R ¹	15	17	19	23
	L ²	94	109	122	143
3-1/2	R ¹	16	19	21	25
	L ²	102	117	131	155
4	R ¹	17	20	22	26
	L ²	109	126	140	166

¹R = Centerline Length of Pipe.

²L = Centerline Minimum Radius (inches).



REFRIGERANT PIPING SYSTEM ENGINEERING

NOTICE

Various tools are available to assist in properly designing LG R32 split systems. Refer to the “R32 Application Guide”; the “Simple Calculator for Capacity, Refrigerant Charge and ESP”; the “LG Air Conditioner Technical Solutions” (LATS) software program; and the local LG Sales Representative.

Proper system operation depends on the installer using utmost care while assembling the piping system. The following pages are an overview of best practices when installing the refrigerant piping system.

NOTICE

LG Electronics U.S.A., Inc., is not responsible for any piping calculations, refrigerant leaks, degradation of performance, any other potential problems or damages caused by the interconnecting piping, their joint connections, isolation valves, or introduced debris inside the piping system.

⊘ No Pipe Size Substitutions

Use only the pipe size selected by the information in this manual. Using a different size is prohibited and will result in a system malfunction or failure to work at all.

⊘ No In-line Refrigeration Components

Components such as oil traps, solenoid valves, filter-driers, sight glasses, tee fittings, and other after-market accessories are ⊘ not permitted on the refrigerant piping system between the outdoor units and the indoor units. LG Single Zone systems are provided with redundant systems that make sure oil is properly returned to the compressor. Sight-glasses and solenoid valves will cause vapor to form in the liquid stream. Over time, driers will deteriorate and introduce debris into the system. The designer and installer must verify the refrigerant piping system is free of traps, sagging pipes, sight glasses, filter driers, etc.

Field-Provided Isolation Ball Valves

LG maintains a neutral position on using isolation valves in LG HVAC refrigerant piping systems. LG does not endorse any manufacturer of isolation valves. It is recognized that installing isolation valves will simplify future maintenance requirements, and, if used, considerations must be taken including, but not limited to, the following:

- Pressure drops for any component used, including isolation valves, must be known in equivalent pipe length and calculated into the total and segment equivalent piping lengths and compared to product design limitations.
- In all cases, materials must be suitable for the application and any applicable codes, including, but not limited to, diameter and wall thickness continuity per ACR standards.

Failure to do so will cause significant performance degradation. Proper leak checks must be performed. Using isolation valves does not automatically void any LG product warranty, however, a limited warranty will be voided in whole or part if any field supplied accessory fail in any way that causes product failure.

Using Elbows

Field-supplied elbows are allowed if they are long radius and designed for use with R32 refrigerant. The designer and installer, however, must be cautious with the quantity and size of fittings used, and must account for the additional pressure losses in equivalent pipe length calculation for each branch. The equivalent pipe length of each elbow must be added to each pipe segment in the LATS program.

Pipe Bends

When bending soft copper, use long radius bends. Refer to the “Radii of Coiled Expansion Loops and Developed Lengths of Expansion Offsets” table on the previous page for minimum radius specifications.

REFRIGERANT PIPING SYSTEM ENGINEERING

NOTICE

Various tools are available to assist in properly designing LG R32 split systems. Refer to the "R32 Application Guide"; the "Simple Calculator for Capacity, Refrigerant Charge and ESP"; the "LG Air Conditioner Technical Solutions" (LATS) software program; and the local LG Sales Representative.

Obstacles

When an obstacle, such as an I-beam or concrete T, is in the path of the planned refrigerant pipe run, it is best practice to route the pipe over the obstacle. If adequate space is not available to route the insulated pipe over the obstacle, then route the pipe under the obstacle. In either case, it is imperative the length of the horizontal section of pipe above or below the obstacle be a minimum of three (3) times the longest vertical rise (or fall) at either end of the segment.

Figure 53: Installing Piping Above and Below an Obstacle.

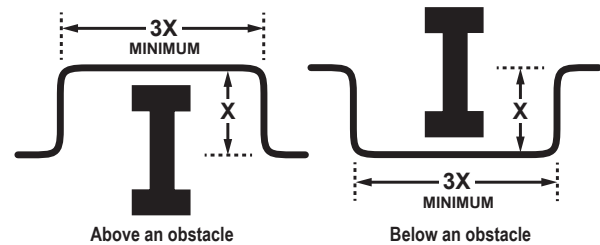

Pipe Supports

A properly installed pipe system must be adequately supported to avoid pipe sagging. Sagging pipes become oil traps that lead to equipment malfunction.

Pipe supports must \odot never touch the pipe wall; supports must be installed outside (around) the primary pipe insulation jacket. Insulate the pipe first because pipe supports must be installed outside (around) the primary pipe insulation jacket. Clevis hangers must be used with shields between the hangers and insulation. Field provided pipe supports must be designed to meet local codes. If allowed by code, use fiber straps or split-ring hangers suspended from the ceiling on all-thread rods (fiber straps or split ring hangers can be used as long as they do not compress the pipe insulation). Place a second layer of insulation over the pipe insulation jacket to prevent chafing and compression of the primary insulation within the confines of the support pipe clamp.

A properly installed pipe system will have sufficient supports to avoid pipes from sagging during the life of the system. As necessary, place supports closer for segments where potential sagging could occur. Maximum spacing of pipe supports must meet local codes. If local codes do not specify pipe support spacing, pipe must be supported:

- Maximum of five (5) feet on center for straight segments of pipe up to 3/4 inches outside diameter size.
- Maximum of six (6) feet on center for pipe up to one (1) inch outside diameter size.
- Maximum of eight (8) feet on center for pipe up to two (2) inches outside diameter size.

Wherever the pipe changes direction, place a hanger within twelve (12) inches on one side and within twelve (12) to nineteen (19) inches of the bend on the other side.

Support piping at indoor unit(s) as shown.

Figure 54: Pipe Hanger Details.

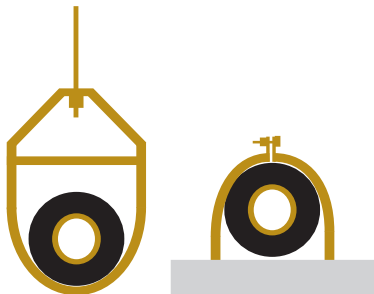

Figure 55: Typical Pipe Support Location—Change in Pipe Direction.

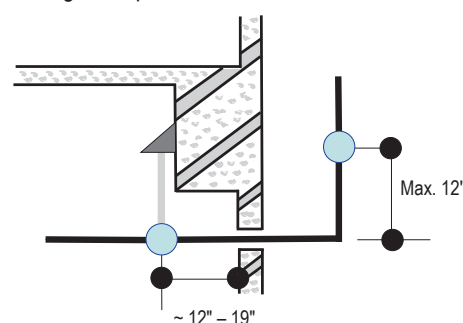
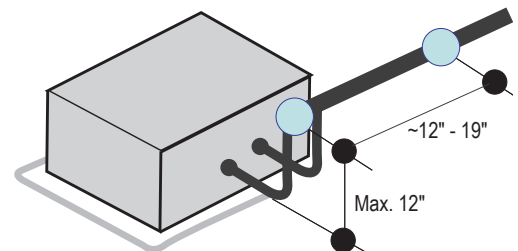

Figure 56: Pipe Support at Indoor Unit.



NOTICE

Use a 4" + long sheet curved sheet metal saddles between hanger bracket and insulation to promote linear expansion/contraction.

REFRIGERANT PIPING SYSTEM ENGINEERING

NOTICE

Various tools are available to assist in properly designing LG R32 split systems. Refer to the "R32 Application Guide"; the "Simple Calculator for Capacity, Refrigerant Charge and ESP"; the "LG Air Conditioner Technical Solutions" (LATS) software program; and the local LG Sales Representative.

Pipe Sleeves at Penetrations

LG recommends that all pipe penetrations through walls, floors, and pipes buried underground be properly insulated and routed through an appropriate wall sleeve of sufficient size to prevent compression of refrigerant pipe insulation and free movement of the pipe within the sleeve. Use 4"+ curved sheet metal saddles between the bottom surface of the pipe and the bottom surface of the penetration.

Figure 57: Pipe Sleeve Options.

Inside wall (concealed)

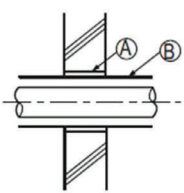

Outside wall

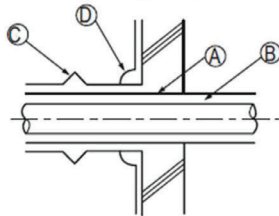

Outside wall (exposed)

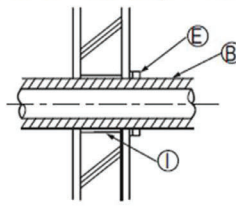

Floor (fire-resistance)

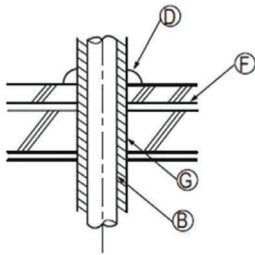

Roof pipe shaft

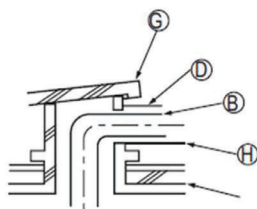

Area between fire-resistant insulation and boundary wall

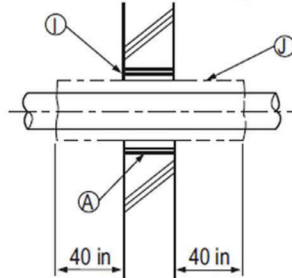

- Ⓐ Sleeve
- Ⓑ Insulation
- Ⓒ Lagging
- Ⓓ Caulk
- Ⓔ Band
- Ⓕ Water-resistant layer
- Ⓖ Sleeve with edge
- Ⓗ Lagging
- Ⓘ Mortar or other fire-resistant caulk
- ⓵ Fire-resistant insulation

When filling an access hole with mortar, cover the area with steel plate so that the insulation will not fall through. For this area, use fire-resistant materials for both the insulation and cover. (Vinyl cover should not be used.)

NOTICE

Diameter of penetrations must be determined by pipe diameter plus the thickness of the insulation.

ELECTRICAL

General Guidelines on page 102

Wiring Diagrams on page 103

Power Supply / Power Wiring on page 112

Power Wiring / Communication Wiring on page 113

Controllers on page 114

GENERAL GUIDELINES

General Electrical Guidelines

⚠ WARNING

- *Separately wire the high and low voltage lines. There is a risk of electric shock, physical injury, or death.*
- *Use heat-proof electrical wire capable of withstanding temperatures up to 167°F to avoid wiring malfunction and electrical shock, which may cause physical injury or death.*
- *Power wiring and communication cables must be firmly attached to the terminals; connect the wiring so that the wires cannot be easily pulled out. Loose wiring may cause unit malfunction, the wires to burnout or the terminal to overheat and catch fire. There is a risk of electric shock, physical injury or death.*
- *Terminal screws will become loose during transport. Properly tighten the terminal connections during installation or risk electric shock, physical injury, or death.*
- *Use outdoor and waterproof connection cable rated up to 300V for the connection between the indoor and outdoor unit to avoid electrical shock, which may cause physical injury or death.*

NOTICE

- *Separately wire the high and low voltage lines to avoid damage to units.*
- *⊘ Do not install power wiring to the outdoor unit and the communication / connection (power) cable to the indoor unit in the same conduit. Use separate conduits.*
- *Local codes may require field-installed disconnect switches from outdoor unit to indoor unit.*
- *Use heat-proof electrical wire capable of withstanding temperatures up to 167°F to avoid damage to unit.*
- *Always use a circuit breaker or time delay fuse when connecting electrical wiring to the unit.*
- *Power wiring and communication cables must be firmly attached to the terminals. Loose wiring may cause unit malfunction, the wires to burnout or the terminal to overheat and catch fire. There is a risk of equipment malfunction or property damage.*
- *Terminal screws will become loose during transport. Properly tighten the terminal connections during installation or risk equipment malfunction or property damage. There is a risk of equipment malfunction or property damage.*
- *Use outdoor and waterproof connection cable rated up to 300V for the connection between the indoor and outdoor unit to avoid damage to the unit.*
- *Comply with local codes while running wire from the indoor unit to the outdoor unit.*
- *⊘ Do not allow wire to touch refrigerant piping, the compressor or any moving parts since it can lead to mechanical failure.*

WIRING DIAGRAMS

KUSXB091A, KUSXB121A Outdoor Units

Figure 58: KUSXB091A, KUSXB121A Outdoor Unit Wiring Diagram.

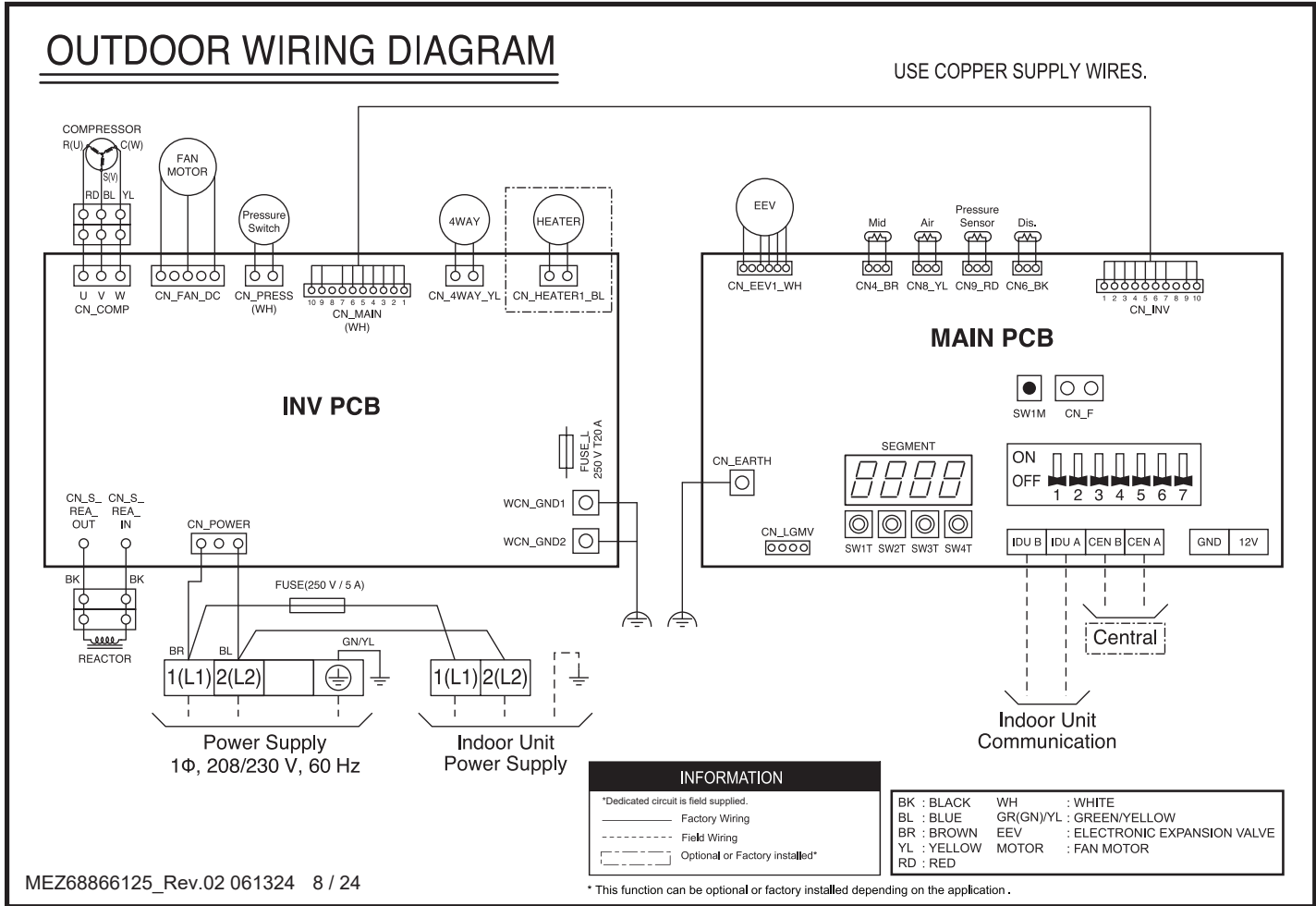

Electrical

WIRING DIAGRAMS

KUSXB421A, KUSXB481A Outdoor Units

Figure 60: KUSXB421A, KUSXB481A Outdoor Unit Wiring Diagram.

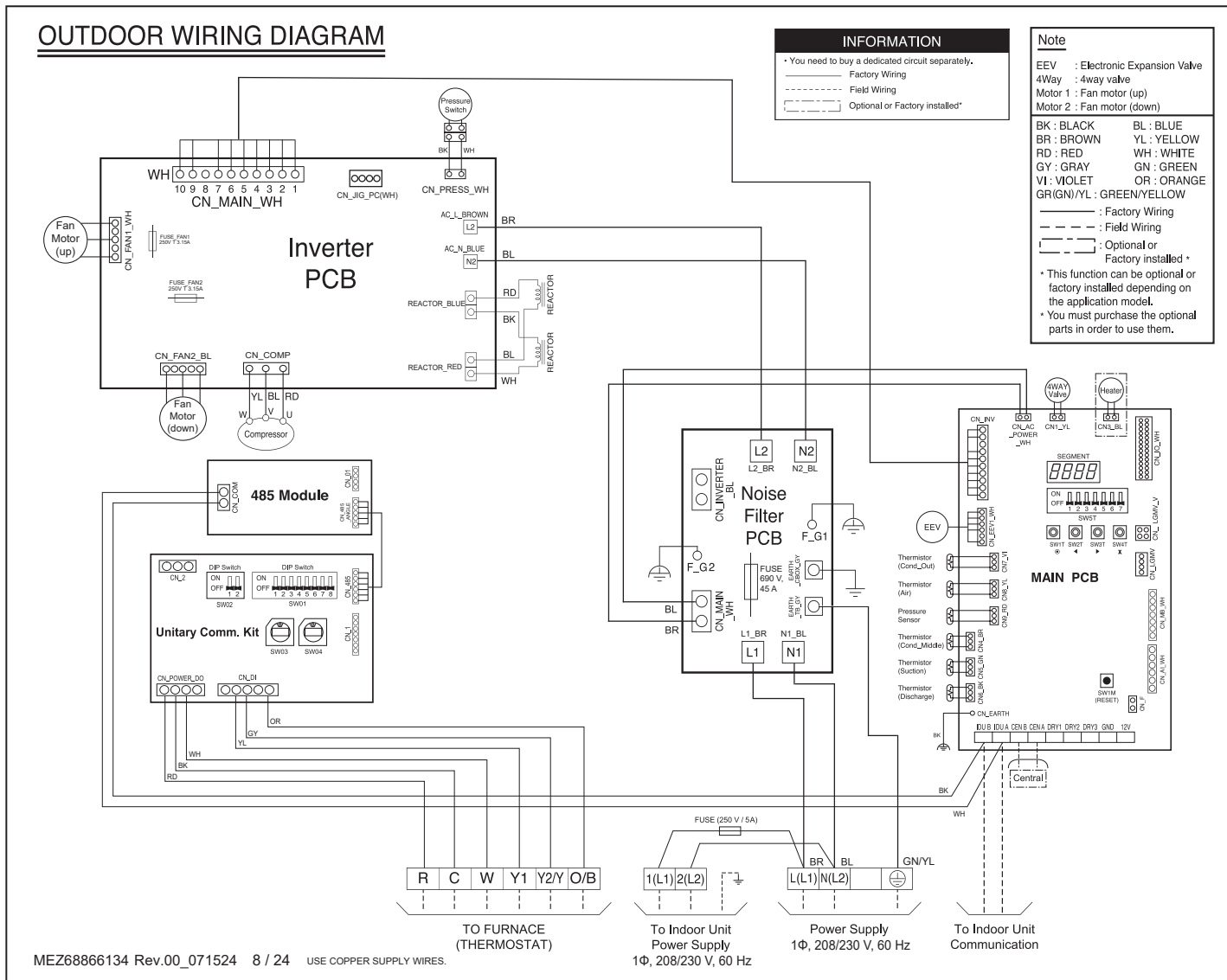

WIRING DIAGRAMS

KNUDB091A, KNUDB121A, KNUDB181A Indoor Units

Figure 61: KNUDB091A, KNUDB121A, KNUDB181A Indoor Unit Wiring Diagram.

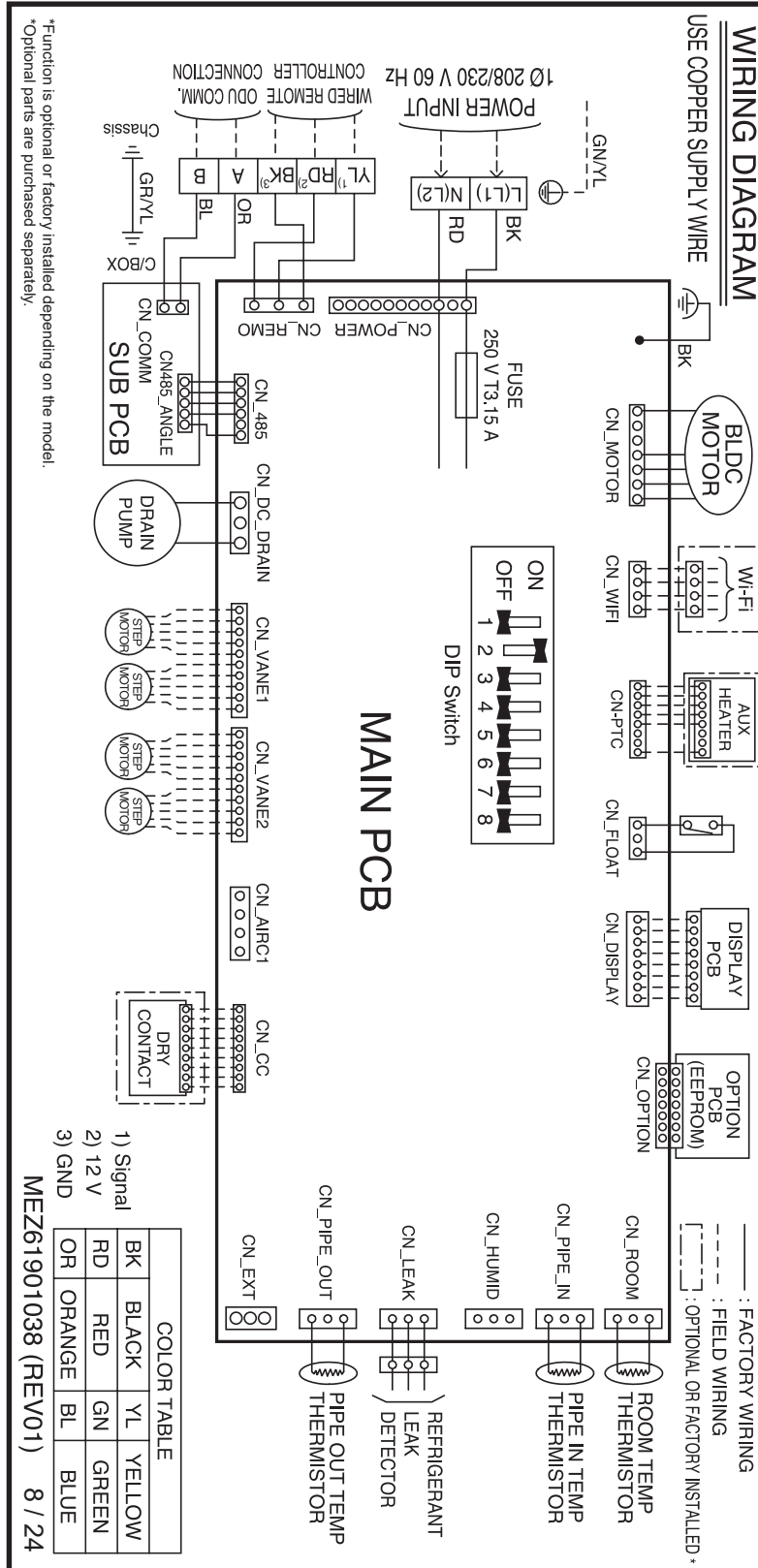

WIRING DIAGRAMS

KNUDB091A, KNUDB121A, KNUDB181A Indoor Units

Table 74: KNUDB091A, KNUDB121A, KNUDB181A Indoor Unit Wiring Diagram Legend.

Terminal	Purpose	Function
CN_MOTOR	Fan motor output	Motor output of BLDC
CN_WIFI	Wifi	Wifi Module connection
CN_PTC	Auxiliary Heater Relay Kit	Auxiliary Heater Relay Kit Second stage heat
CN_FLOAT	Float switch input	Float switch sensing
CN_DISPLAY	Display	Display of indoor status
CN_OPTION	Optional PCB EEPROM	Option PCB connection
CN_ROOM	Room sensor	Room air thermistor
CN_PIPE_IN	Suction pipe sensor	Pipe in thermistor
CN_HUMID	Humidity sensor	Humidity sensor connection
CN_LEAK	Refrigerant leak detector	Refrigerant leak detector connection
CN_PIPE_OUT	Discharge pipe sensor	Pipe out thermistor
CN_EXT	External ON / OFF controller	External ON / OFF controller connection
CN_CC	Dry contact	Dry contact connection
CN_AIRC1	Air cleaner	Air cleaner connection
CN_VANE2	Step motor	Step motor output
CN_VANE1	Step motor	Step motor output
CN_DC_DRAIN	Drain pump	Drain pump connection
CN_485	Communication connection	Connection for communication between ODU and IDU
CN_REMO	Wired remote controller	Wired remote control connection
CN_POWER	AC power supply AC	Power line

Table 75: KNUDB091A, KNUDB121A, KNUDB181A Indoor Unit DIP Switch Settings.

DIP Switch	Function	Off	On	Description
SW3	GROUP CONTROL	Main	Sub	Group control setting using 7-Day Programmable Controller; selects Main / Sub on each indoor unit.
SW4	DRY CONTACT MODE	Variable	Auto	Sets operation mode for optional Dry Contact accessory. 1. Variable: Auto or Manual Mode can be set through 7-Day Programmable Controller or Wireless Remote Controller (factory default setting is Auto if there is no setting). 2. Auto: For Dry Contact, it is always Auto mode.
SW7	VENTILATOR INTERLOCK	Off	On	Selects ventilator interlock function for four-way ceiling cassette indoor units. 1. On: Automatic (vent relay will be turned on after ten [10] seconds of indoor unit operation). 2. Off: Manual (ventilator needs to be set through the controller).

***SW3 Group Control is not applicable for single zone systems.**

***For single zone four-way ceiling cassette indoor units, DIP switches 1, 2, 5, 6, and 8 must be set to OFF.**

WIRING DIAGRAMS

KNSCB241A, KNSCB301A, KNSCB361A Indoor Units

Figure 62: KNSCB241A, KNSCB301A, KNSCB361A Indoor Unit Wiring Diagram.

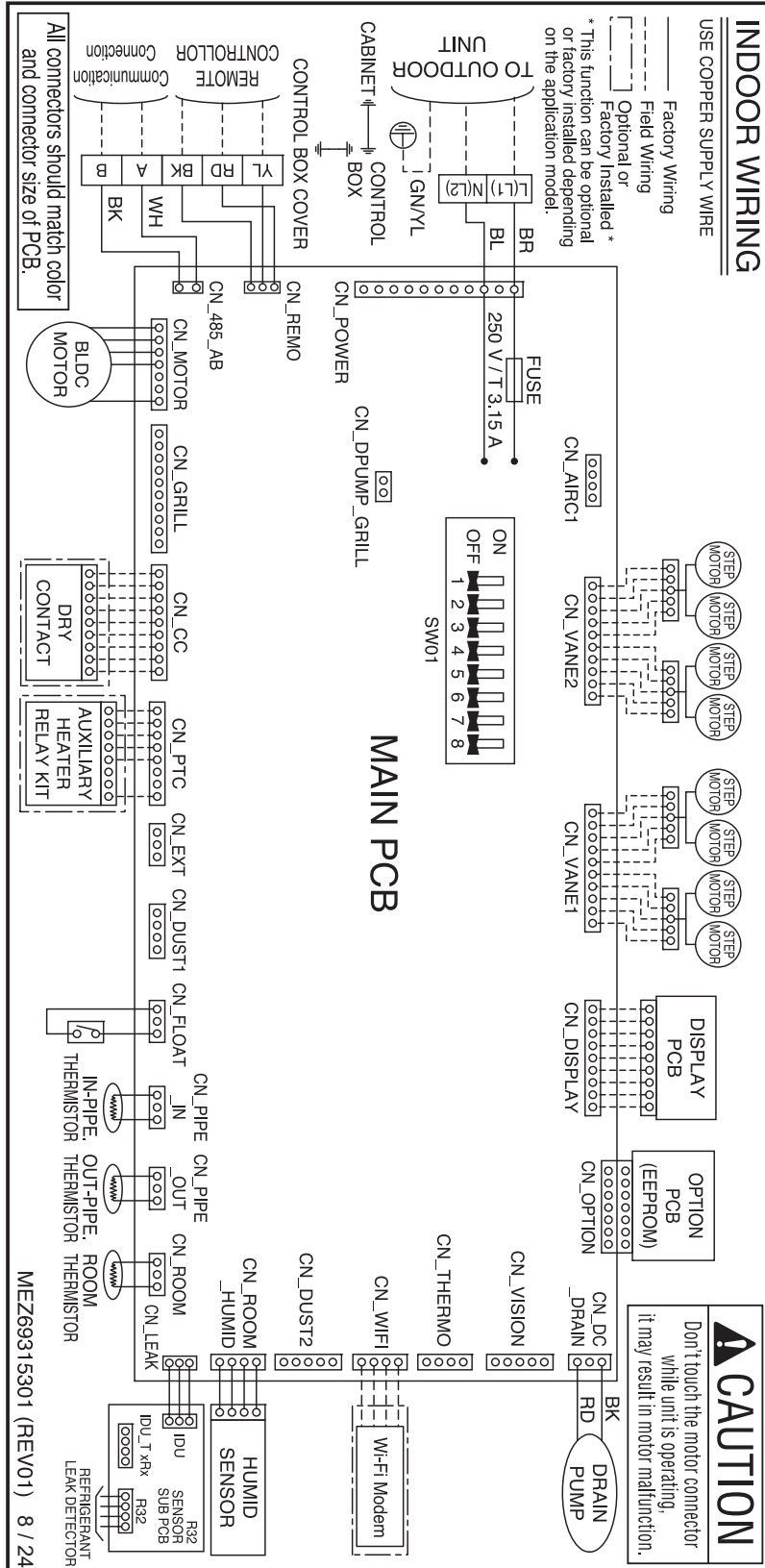

WIRING DIAGRAMS

KNSCB241A, KNSCB301A, KNSCB361A Indoor Units

Table 76: KNSCB241A, KNSCB301A, KNSCB361A Indoor Unit Wiring Diagram Legend.

Terminal	Purpose	Function
CN_AIRC1	Air cleaner	Air cleaner connection
CN_VANE2	Step motor	Step motor output
CN_VANE1	Step motor	Step motor output
CN_DISPLAY	Display	Display of indoor status
CN_OPTION	Optional PCB EEPROM	Option PCB connection
CN_DC_DRAIN	Drain pump	Drain pump connection
CN_WIFI	Wifi	Wifi module connection
CN_ROOM_HUMID	Humidity sensor	Humidity sensor connection
CN_LEAK	Refrigerant leak detector	Refrigerant leak detector connection
CN_ROOM	Room sensor	Room air thermistor
CN_PIPE_OUT	Discharge pipe sensor	Pipe out thermistor
CN_PIPE_IN	Suction pipe sensor	Pipe in thermistor
CN_FLOAT	Float switch input	Float switch sensing
CN_DUST1	PM1.0 Sensor	Indoor air quality monitoring
CN_EXT	External ON / OFF controller	External ON / OFF controller connection
CN_PTC	Auxiliary heater relay kit	Auxiliary heater relay kit second stage heat
CN_CC	Dry contact	Dry contact connection
CN_GRILL	Grille connector	Grille operations connection
CN_MOTOR	Fan motor output	Motor output of BLDC
CN_485_AB	Communication connection	Connection for communication between ODU and IDU
CN_REMO	Wired remote controller	Wired remote control connection
CN_POWER	AC power supply AC	Power line

Electrical

Table 77: KNSCB241A, KNSCB301A, KNSCB361A Indoor Unit DIP Switch Settings.

DIP Switch	Function	Off	On	Description
SW3	GROUP CONTROL	Main	Sub	Group control setting using 7-Day Programmable Controller; selects Main / Sub on each indoor unit.
SW4	DRY CONTACT MODE	Variable	Auto	Sets operation mode for optional Dry Contact accessory. 1. Variable: Auto or Manual Mode can be set through 7-Day Programmable Controller or Wireless Remote Controller (factory default setting is Auto if there is no setting). 2. Auto: For Dry Contact, it is always Auto mode.
SW7	VENTILATOR INTERLOCK	Off	On	Selects ventilator interlock function for four-way ceiling cassette indoor units. 1. On: Automatic (vent relay will be turned on after ten [10] seconds of indoor unit operation). 2. Off: Manual (ventilator needs to be set through the controller).

*SW3 Group Control is not applicable for single zone systems.

*For single zone four-way ceiling cassette indoor units, DIP switches 1, 2, 5, 6, and 8 must be set to OFF.

WIRING DIAGRAMS

KNSCB421A, KNSCB481A Indoor Units

Figure 63: KNSCB421A, KNSCB481A Indoor Unit Wiring Diagram.

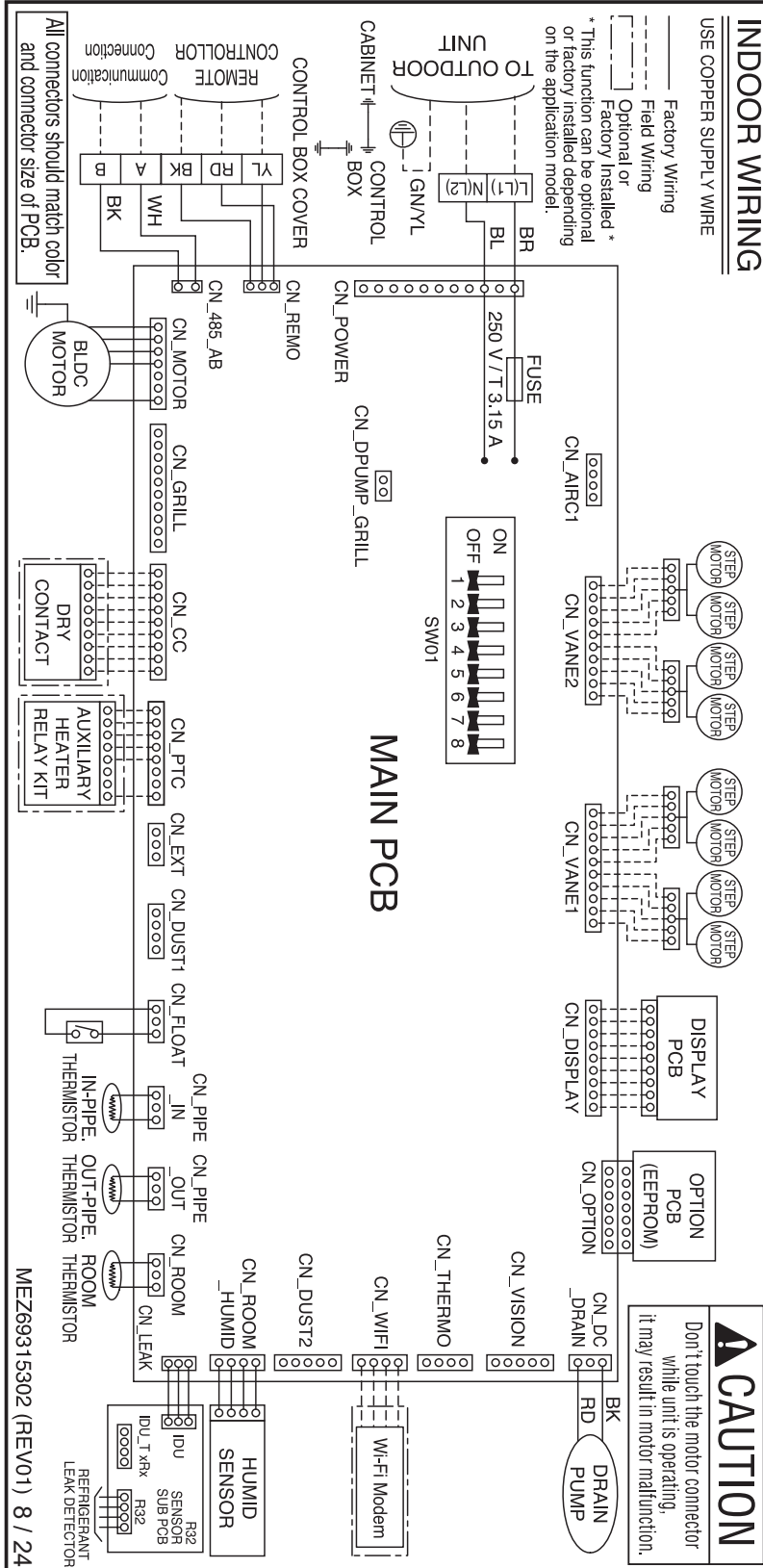

WIRING DIAGRAMS

KNSCB421A, KNSCB481A Indoor Units

Table 78: KNSCB421A, KNSCB481A Indoor Unit Wiring Diagram Legend.

Terminal	Purpose	Function
CN_AIRC1	Air Cleaner	Air Cleaner connection
CN_VANE2	Step motor	Step motor output
CN_VANE1	Step motor	Step motor output
CN_DISPLAY	Display	Display of indoor status
CN_OPTION	Optional PCB EEPROM	Option PCB connection
CN_DC_DRAIN	Drain pump	Drain pump connection
CN_WIFI	Wifi	Wifi Module connection
CN_ROOM_HUMID	Humidity sensor	Humidity sensor connection
CN_LEAK	Refrigerant leak detector	Refrigerant leak detector connection
CN_ROOM	Room sensor	Room air thermistor
CN_PIPE_OUT	Discharge pipe sensor	Pipe out thermistor
CN_PIPE_IN	Suction pipe sensor	Pipe in thermistor
CN_FLOAT	Float switch input	Float switch sensing
CN_DUST1	PM1.0 Sensor	Indoor air quality monitoring
CN_EXT	External ON / OFF controller	External ON / OFF controller connection
CN_PTC	Auxiliary Heater Relay Kit	Auxiliary Heater Relay Kit second stage heat
CN_CC	Dry contact	Dry contact connection
CN_GRILL	Grille connector	Grille operations connection
CN_MOTOR	Fan motor output	Motor output of BLDC
CN_485_AB	Communication connection	Connection for communication between ODU and IDU
CN_REMO	Wired remote controller	Wired remote control connection
CN_POWER	AC Power supply AC	Power line

Table 79: KNSCB421A, KNSCB481A Indoor Unit DIP Switch Settings.

DIP Switch	Function	Off	On	Description
SW3	GROUP CONTROL	Main	Sub	Group control setting using 7-Day Programmable Controller; selects Main / Sub on each indoor unit.
SW4	DRY CONTACT MODE	Variable	Auto	Sets operation mode for optional Dry Contact accessory. 1. Variable: Auto or Manual Mode can be set through 7-Day Programmable Controller or Wireless Remote Controller (factory default setting is Auto if there is no setting). 2. Auto: For Dry Contact, it is always Auto mode.
SW7	VENTILATOR INTERLOCK	Off	On	Selects ventilator interlock function for four-way ceiling cassette indoor units. 1. On: Automatic (vent relay will be turned on after ten [10] seconds of indoor unit operation). 2. Off: Manual (ventilator needs to be set through the controller).

*SW3 Group Control is not applicable for single zone systems.

*For single zone four-way ceiling cassette indoor units, DIP switches 1, 2, 5, 6, and 8 must be set to OFF.

POWER SUPPLY / POWER WIRING

Power Supply / Power Wiring

- LG single zone systems operate at 1Ø, 208-230V, 60Hz; confirm power source specifications.
- Follow manufacturer's circuit diagrams displayed on the inside of the control box cover.
- It is recommended that a circuit breaker is installed, especially if conditions could become wet or moist.
- Include a disconnect in the power wiring system. Add an air gap contact separation of at least 1/8 inch in each active (phase) conductor.
- Power wiring to the outdoor unit(s) must be a minimum of 12 AWG, three (3) conductor for 9,000, 12,000, 18,000 and 24,000 Btu/h capacities; a minimum of 10 AWG, three (3) conductor for 30,000, 36,000, 42,000, and 48,000 Btu/h capacities; solid or stranded; and must comply with all National Electrical Code (NEC), UL, and local electrical codes.
- Maximum allowable voltage fluctuation $\pm 10\%$ or nameplate rated value. Confirm that the electrical capacity is sufficient.

A voltage drop will cause the following problems:

- Magnetic switch vibration, fuse breaks, or disturbance to the normal function of an overload protection device.
- Compressor will not receive the proper starting current.
- Any openings where the field wiring enters the cabinet must be completely sealed.
- Properly ground the outdoor unit and the indoor unit per National Electrical Code (NEC) and local codes.
- The indoor unit is powered by the outdoor unit. See the next page for power wiring / communication wiring specifications from the outdoor unit to the indoor unit.
- Ground wire must be longer than the common power / communication wires.
- Always match color codes of each wire and follow wiring diagram.

Figure 64: Circuit Breaker.

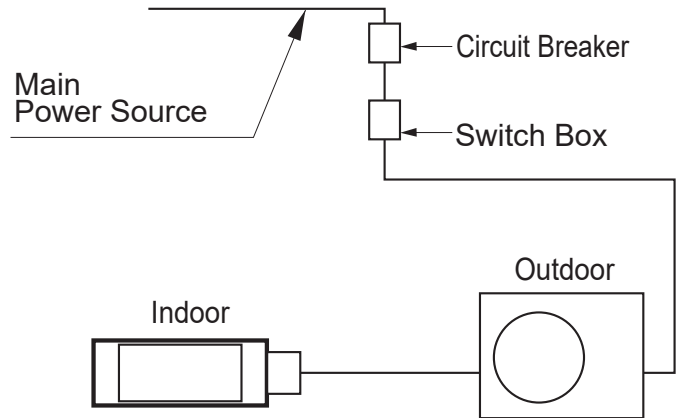

Figure 65: Power Wiring Example.

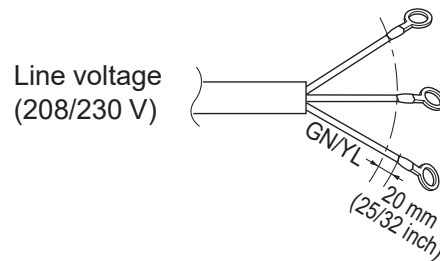
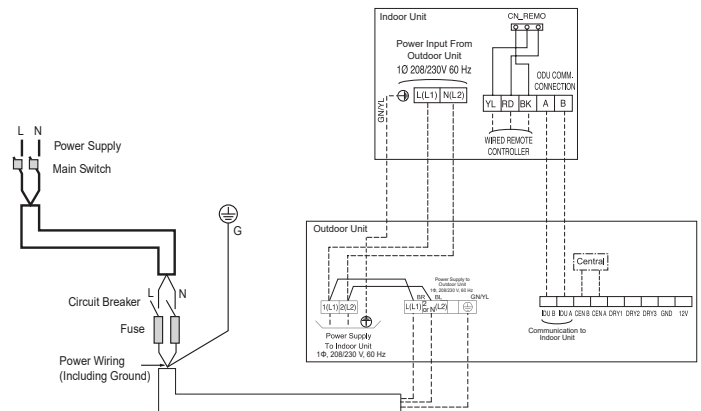

Figure 66: General R32 Single-Zone System Power / Communications System Schematic (Appearances May Vary).



POWER WIRING / COMMUNICATION WIRING

Power Wiring / Communication Wiring Specifications from Outdoor Unit to Indoor Unit

- Power wiring from the single zone outdoor unit to the indoor unit must use a minimum of 14 AWG, three (3) conductor, stranded, shielded or unshielded (if shielded, must be grounded to the chassis of the outdoor unit only), and must comply with applicable local and national codes.
- Communication wiring from the single zone outdoor unit to the indoor unit must be a minimum of 18 AWG, two (2) conductor, stranded, shielded or unshielded (if shielded, must be grounded to the chassis of the outdoor unit only), and must comply with applicable local and national codes.
- Use of stranded, shielded or unshielded wire is allowed for lengths up to the published maximum pipe length, plus recommended slack at both ends.
- Insulation material as required by local code.
- Firmly attach the cable; provide slack but secure in a way to prevent external forces from being imparted on the terminal block.
- Wiring must be completed without splices.
- When the power wire and communication wire length between the outdoor unit and indoor unit is GREATER THAN 130 feet:
 - Use minimum 14 AWG communication wiring OR
 - Separate the power wiring AT LEAST two (2) inches from the communication wiring.

⚠ WARNING

All power wiring and communication wiring installation must be performed by trained service providers working in accordance with local, state, and National Electrical Code (NEC) / UL / ETL federal regulations related to electrical equipment and wiring, and following the manufacturer product diagrams, requirements, and instructions in this manual. Failure to do so will lead to electric shock which can cause physical injury or death.

NOTICE

- Always verify the communication wiring is connected to a communications terminal on the Single Zone unit. ⚡ Never apply line voltage power to the communication cable connection. If contact is made, the PCBs will be damaged.
- The shield of the communications wiring connecting the outdoor unit to the indoor unit must be grounded only to the outdoor unit frame.
- Tie the shield of each cable segment together using a wire nut at the indoor unit. Maintain polarity throughout the communication network.
- Position the incoming power to the outdoor unit away from the power wiring and communications wiring from the outdoor unit to the indoor unit.
- ⚡ Never use a common multiple-core communications cable.

NOTICE

- Make sure the communications wiring and the power wiring from the outdoor unit to the indoor unit and the power wiring to the outdoor unit are separate, otherwise, the outdoor unit operation will be affected by electrical noise and will malfunction or fail.
- Use a conduit for the communications cable / power wiring from the outdoor unit to the indoor units.

Figure 67: R32 Single-Zone Outdoor Unit to Indoor Unit Wiring and Communications Wiring Diagrams.

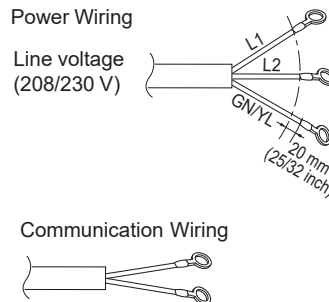

Figure 68: R32 Single-Zone Outdoor Unit to Indoor Unit Wiring and Communications Wiring Diagrams GREATER THAN 130 feet.

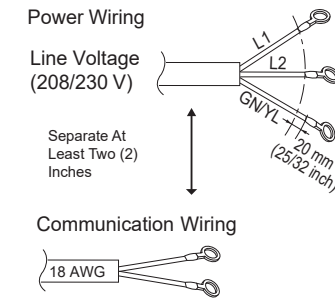
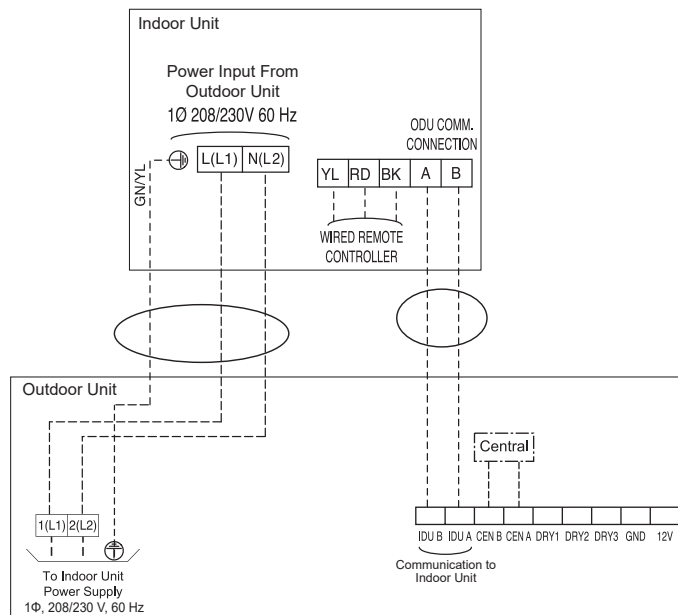

Figure 69: R32 Single-Zone Power / Communication Terminals (Appearances May Vary Slightly).



CONTROLLERS

Controller Options

Single Zone Four-Way Ceiling Cassette systems include a wireless handheld remote controller (For 9, 12, 18k Systems: PQWRHQ0FDB; For 24, 30, 36, 42k, 48k Systems: PWLSSB21H). Optional LG-supplied wired controllers are available. See “Functions, Controls, Options”, or contact an LG representative for more information.

Wireless Handheld Remote Controller features:

- Display Panel: Displays operation conditions.
- On / Off Buttons: Turns system operation on and off.
- Mode Button: Selects the operation mode: Cooling, Heating, Auto, Dry (Dehumidification), or Fan.
- Temp Up / Down Buttons: Adjusts the desired room temperature in the different modes.
- Fan Speed Button: Sets desired fan speed.
- Reset: Initializes the handheld remote control settings.

Figure 72: PQWRHQ0FDB Wireless Handheld Remote Controller.

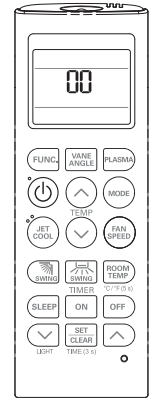

NOTICE

Each function will display on the LED for about three (3) seconds when the power is first cycled on.

Wired Controller Connections

Optional controllers (see “Functions, Controls, Options”, or contact an LG representative for more information) can connect to the indoor unit in one of two different ways.

1. LG Wired Remote Extension Cable with Molex plug (PZCWRC1; sold separately) that connects to the CN_REMO terminal on the indoor unit PCB.
2. Field-supplied controller cable that connects to the indoor unit terminal block (must be at least UL2547 or UL1007, and at least FT-6 rated if local electric and building codes require plenum cable usage). Communication cable from indoor unit to remote controller(s) is to be 22 AWG, 3-conductor, twisted, stranded, unshielded. Wiring must comply with all applicable local and national codes.

Figure 70: PZCWRC1 LG Wired Remote Extension Cable.

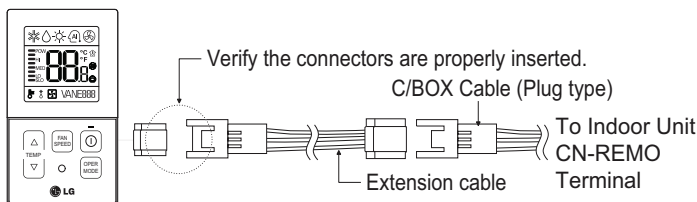

NOTICE

When using field-supplied controller cable, make sure to connect the yellow to yellow (communications wire), red to red (12V power wire), and black to black (ground wire) terminals from the remote controller to the indoor unit terminal blocks.

Figure 71: Wired Controller Connection (Example Only).

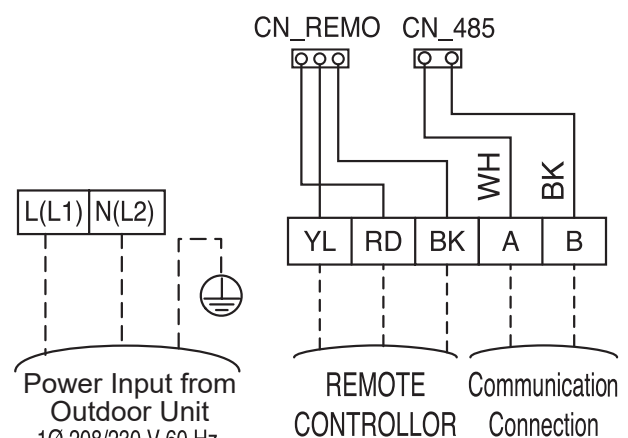

Wired Controller Placement

Wired controllers include a sensor to detect room temperature. To maintain comfort levels in the conditioned space, the wired controller must be installed in a location away from direct sunlight, high humidity, and where it could be directly exposed to cold air. Controller must be installed four (4) to five (5) feet above the floor where its LED display can be read easily, in an area with good air circulation, and where it can detect an average room temperature.

⊘ Do not install the wired controller near or in:

- Drafts or dead spots behind doors and in corners.
- Hot or cold air from ducts.
- Radiant heat from the sun or appliances.
- Concealed pipes and chimneys.
- An area where temperatures are uncontrolled, such as an outside wall.

Figure 73: Proper Location for the Wired Controller.

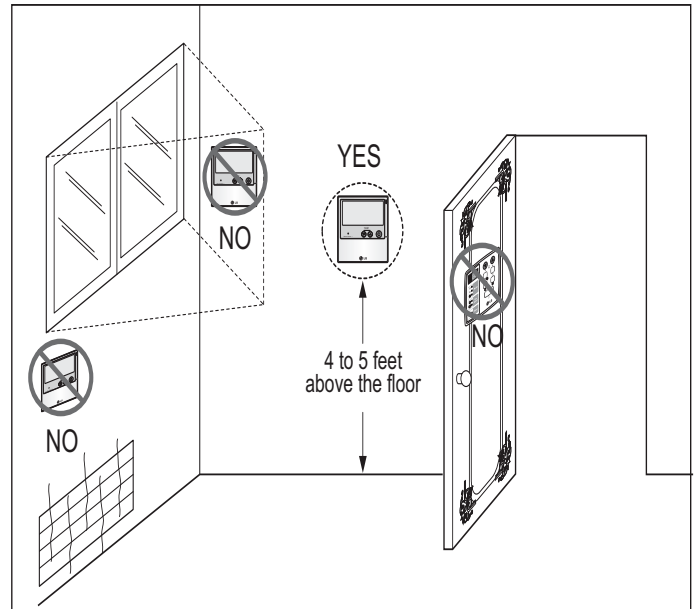

Assigning the Thermistor for Temperature Detection

Each indoor unit includes a return air thermistor assigned to sense the temperature. If a wired controller is installed, there is a choice of sensing temperature with either the indoor unit return air thermistor or the thermistor in the wired controller. It is also an option to set both thermistors to sense temperature so that indoor unit bases its operation on the first thermistor to reach the designated temperature differential. For applicable indoor units, an optional Remote Temperature Sensor can be used in lieu of the return air thermistor—either alone or in conjunction with a wired controller thermistor as previously described.

LIMITED WARRANTY (USA)

The product's full Limited Warranty terms and conditions and arbitration requirements are available at <https://www.lghvac.com>.

Inverter



LG Electronics, U.S.A., Inc.
Air Conditioning Technologies
4300 North Point Parkway
Alpharetta, Georgia 30022
www.lghvac.com