

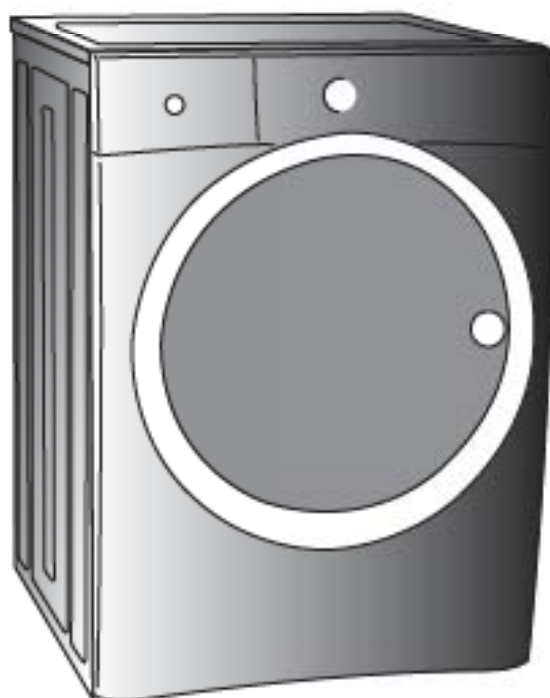

Installation Instructions

Electrolux Front-Load Washer



 **Electrolux**

Please read and save this guide

Thank you for choosing **Electrolux**, the new premium brand in home appliances. These *Installation Instructions* are part of our commitment to customer satisfaction and product quality throughout the life of your new appliance.

We view your purchase as the beginning of a relationship. To ensure our ability to continue serving you, please use this page to record important product information.

Keep a record for quick reference

Purchase date

Electrolux model number

Electrolux serial number

NOTE

Registering your product with Electrolux enhances our ability to serve you. You can register online at www.electroluxappliances.com or by dropping your Product Registration Card in the mail.

Questions?

For toll-free telephone support in the U.S. and Canada: **1-877-4ELECTROLUX (1-877-435-3287)**

For online support and product information visit <http://www.electroluxappliances.com>

Table of contents

Finding information.....	2	• Removing shipping hardware.....	8
SAFETY.....	3	• Installing hole plugs.....	8
• Pre-installation requirements.....	3	Installation instructions.....	9-12
Installation requirements.....	4-9	• Leveling your washer.....	9
• Electrical system requirements.....	4	• Connecting inlet water.....	10
• Grounding requirements.....	4	• Connecting drain & electrical.....	11
• Water supply requirements.....	4	• Performing installation cycle.....	12
• Drain system requirements.....	4	Reversing door.....	13-18
• Clearance requirements.....	5	Options.....	19
• Installed dimensions.....	6	• Accessories.....	19
Unpacking washer.....	7-8	• Replacement parts.....	19
• Removing foam packaging.....	7	Notes.....	20

Important Safety Instructions

Recognize safety symbols, words and labels

Safety items throughout this manual are labeled with a WARNING or CAUTION based on the risk type as described below:

 **WARNING** This symbol alerts you to situations that may cause serious body harm, death or property damage.

 **CAUTION** This symbol alerts you to situations that may cause bodily injury or property damage.

NOTE

The electrical service to the washer must conform with local codes and ordinances and the latest edition of the National Electrical Code, ANSI/NFPA 70, or in Canada, the Canadian electrical code C22.1 part 1.

WARNING

SUFFOCATION HAZARD

Destroy the carton and plastic bags after the washer is unpacked. Children might use them for play. Cartons covered with rugs, bedspreads, or plastic sheets can become airtight chambers causing suffocation. Place all materials in a garbage container or make materials inaccessible to children.

CAUTION

EXCESSIVE WEIGHT HAZARD

To avoid back or other injury, have more than one person move or lift the washer.

WARNING

FIRE HAZARD

For your safety the information in this manual must be followed to minimize the risk of fire or explosion or to prevent property damage, personal injury or loss of life. Do not store or use gasoline or other flammable vapors and liquids in the vicinity of this or any other appliance.

WHAT TO DO IF YOU SMELL GAS:

- Do not try to light any appliance.
- Do not touch any electrical switch; do not use any phone in your building.
- Clear the room, building or area of all occupants.
- Immediately call your gas supplier from a neighbor's phone. Follow the gas supplier's instructions.
- If you cannot reach your gas supplier, call the fire department.

IMPORTANT

The instructions in this manual and all other literature included with this washer are not meant to cover every possible condition and situation that may occur. Good safe practice and caution MUST be applied when installing, operating and maintaining any appliance.

Maximum benefits and enjoyment are achieved when all the Safety and Operating Instructions are understood and practiced as a routine with your laundering tasks.

**Save these instructions
for future reference.**

Pre-installation requirements

Tools and materials needed for installation:



4 Installation Requirements

Electrical system requirements

CIRCUIT - Individual, properly polarized and grounded 15 amp. branch circuit fused with 15 amp. time delay fuse or circuit breaker.

POWER SUPPLY - 2 wire, with ground, 120 volt single phase, 60 Hz, Alternating Current.

NOTE

Because of potentially inconsistent voltage capabilities, the use of this washer with power created by gas powered generators, solar powered generators, wind powered generators or any other generator other than the local utility company is not recommended.

OUTLET RECEPTACLE - Properly grounded 3-prong receptacle to be located so the power supply cord is accessible when the washer is in an installed position.

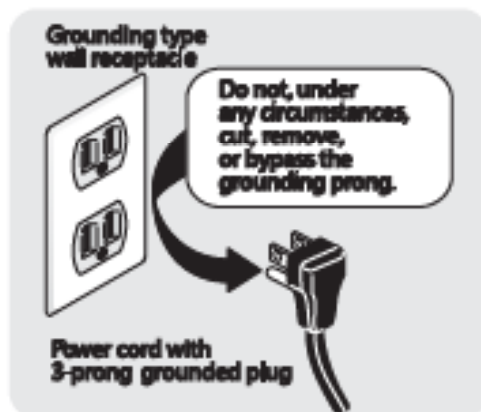

NOTE

GFI (Ground Fault Interrupter) receptacle is not required.

Grounding requirements

WARNING

ELECTRICAL SHOCK HAZARD
Improper connection of the equipment grounding conductor can result in a risk of electrical shock. Check with a licensed electrician if you are in doubt as to whether the appliance is properly grounded.

1. The washer **MUST** be grounded. In the event of malfunction or breakdown, grounding will reduce the risk of electrical shock by a path of least resistance for electrical current.
2. Since your washer is equipped with a power

supply cord having an equipment-grounding conductor and a grounding plug, the plug **MUST** be plugged into an appropriate, copper wired receptacle that is properly installed and grounded in accordance with all local codes and ordinances or in the absence of local codes, with the National Electrical Codes, ANSI/NFPA 70 (latest edition). If in doubt, call a licensed electrician. **DO NOT** cut off or alter the grounding prong on the power supply cord. In situations where a two-slot receptacle is present, it is the owner's responsibility to have a licensed electrician replace it with a properly grounded three prong grounding type receptacle.

Water supply requirements

Hot and cold water faucets **MUST** be installed within 42 inches (107 cm) of your washer's water inlet. The faucets **MUST** be 3/4 inch (1.9 cm) with threading for laundry hose connection. Water pressure **MUST** be between 30 and 120 psi. Pressure difference between hot and cold cannot be more than 10 psi. Your water department can advise you of your water pressure.

Drain system requirements

1. Drain capable of eliminating 17 gals (64.3 L) per minute.
2. A standpipe diameter of 1-1/4 in. (3.18 cm) minimum.
3. The standpipe height above the floor should be:
Minimum height: 24 in. (61 cm)
Maximum height: 96 in. (244 cm)

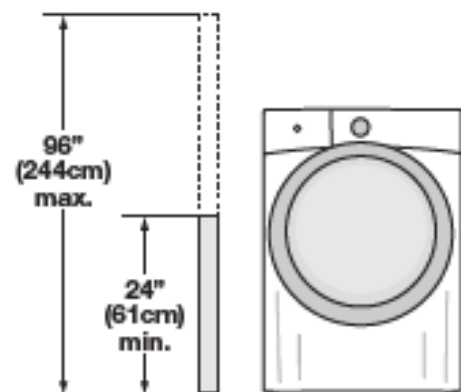

NOTE

Drain hose attached to the washer can reach a 79 in. (201 cm) high standpipe. For higher standpipe, use hose P/N 137096000, available from an authorized parts distributor.

Clearance requirements

➔ IMPORTANT

DO NOT INSTALL YOUR WASHER:

1. In an area exposed to dripping water or outside weather conditions. The ambient temperature should never be below 60° F (15.6° C) to maximize detergent effectiveness.
2. In an area (garage or garage-type building) where gasoline or other flammables (including automobiles) are kept or stored.
3. On carpet. Floor **MUST** be solid with a maximum slope of 1 inch (2.54 cm). To minimize vibration or movement, reinforcement of the floor may be necessary.

INSTALLATION IN A RECESS OR CLOSET

If washer and dryer are installed in the same closet, door ventilation is required: A minimum of 120 square inches (774.2 cm²) of opening, equally divided at the top and bottom of the door, is required. Louvered openings should be located 3 inches (7.6 cm) from bottom and top of door. Air openings are required to be unobstructed when a door is installed. A louvered door with equivalent air openings for the full length of the door is acceptable.

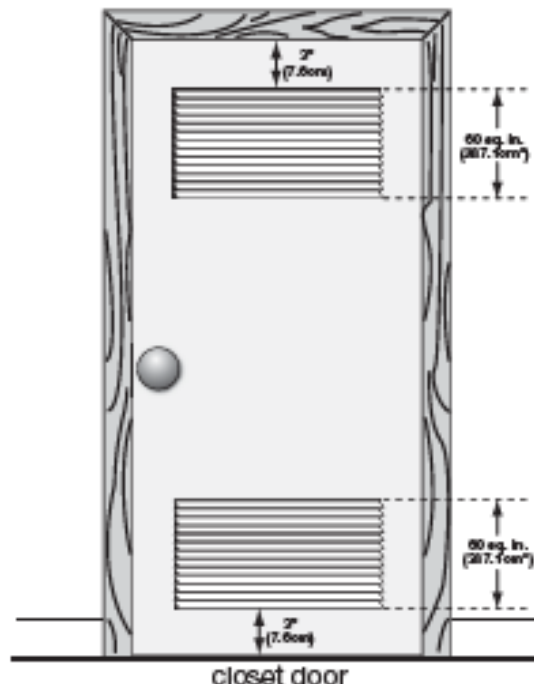

MINIMUM INSTALLATION CLEARANCES - Inches (cm)				
	SIDES	REAR	TOP	FRONT
Alcove	0" (0 cm)	0" (0 cm)*	0" (0 cm)	n/a
Under-Counter	0" (0 cm)	0" (0 cm)*	0" (0 cm)	n/a
Closet	0" (0 cm)	0" (0 cm)*	0" (0 cm)	1" (2.54 cm)

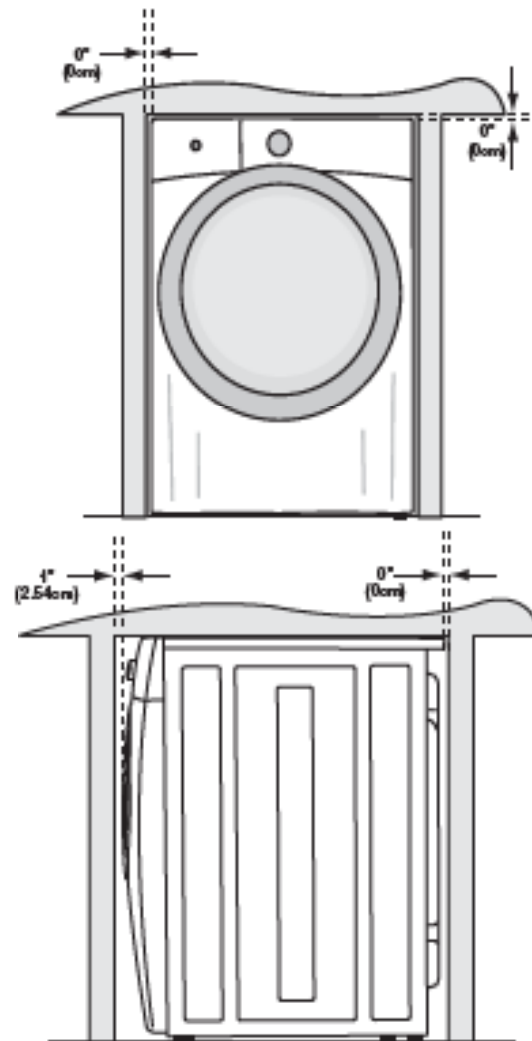

6 Installation Requirements

Installed washer dimensions

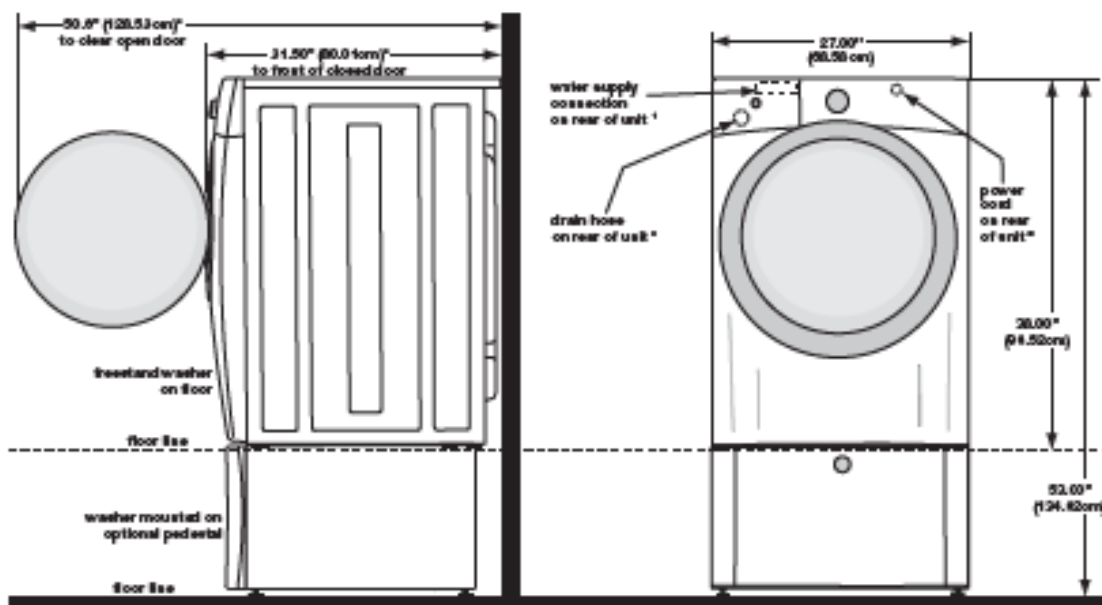

- * To obtain these minimal depth dimensions, dryer must either be vented straight back or with a quick-turn 90° elbow.
- † Connection of water inlet hose on Steam Models adds 24 in. (2 cm) to installation depth.
- * Hot and cold inlet hose length approximately 48.5 inches (123 cm).
- * Drain hose length approximately 90 inches (229 cm).
- * Power supply cord length approximately 60 inches (152.5 cm).

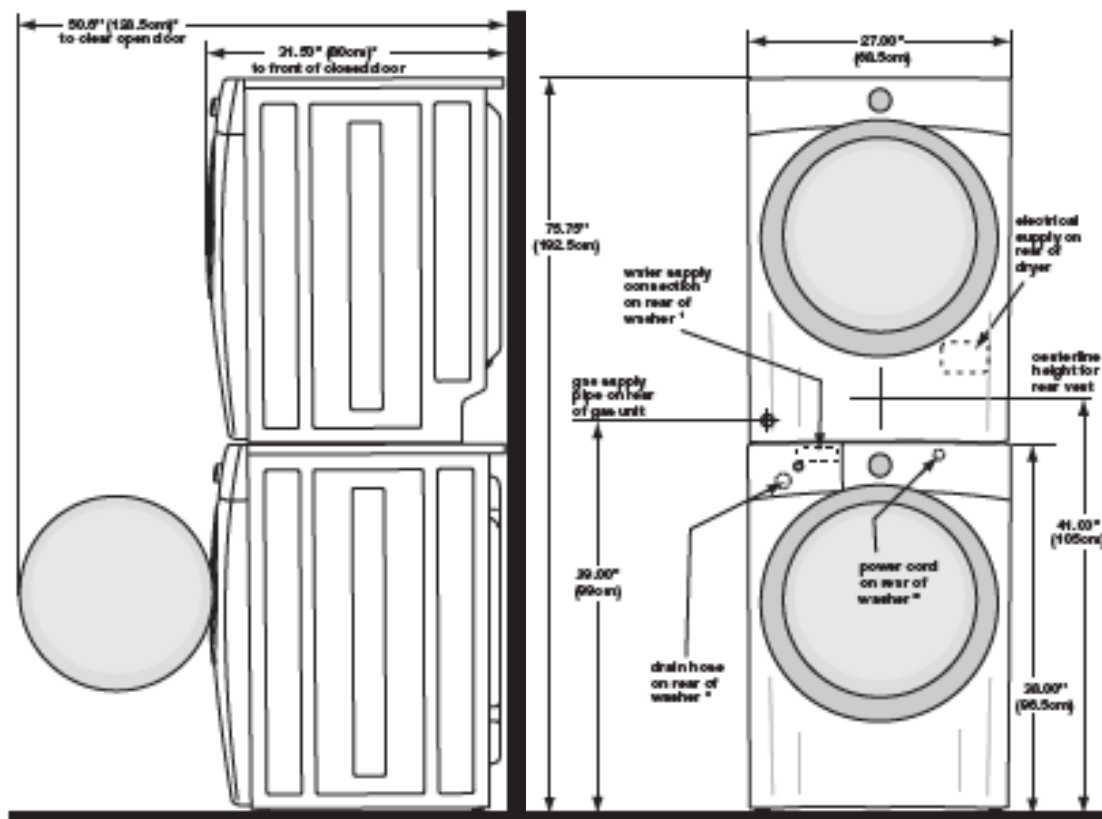

- * To obtain these minimal depth dimensions, dryer must either be vented straight back or with a quick-turn 90° elbow.
- † Connection of water inlet hose on Steam Models adds 24 in. (2 cm) to installation depth.
- * Hot and cold inlet hose length approximately 48.5 inches (123 cm).
- * Drain hose length approximately 90 inches (229 cm).
- * Power supply cord length approximately 60 inches (152.5 cm).

Removing foam packaging

WARNING

SUFFOCATION HAZARD

Destroy the carton and plastic bags after the washer is unpacked. Children might use them for play. Cartons covered with rugs, bedspreads, or plastic sheets can become airtight chambers causing suffocation. Place all materials in a garbage container or make materials inaccessible to children.

1. Temporarily remove door tape.
2. Open washer door and remove everything from the drum.
3. Close door and reapply door tape.
4. Using a rug, blanket or piece of cardboard to protect the floor, carefully lay the washer on it's back.

CAUTION

EXCESSIVE WEIGHT HAZARD

To avoid back or other injury, have more than one person move or lift the washer.

5. Remove styrofoam base and shipping plug and set them aside.
6. Carefully return the washer to an upright position.
7. Carefully move the washer to within 4 feet (1 m) of its final location.

IMPORTANT

Save styrofoam base and shipping plug for use to help prevent washer damage during any future moves.

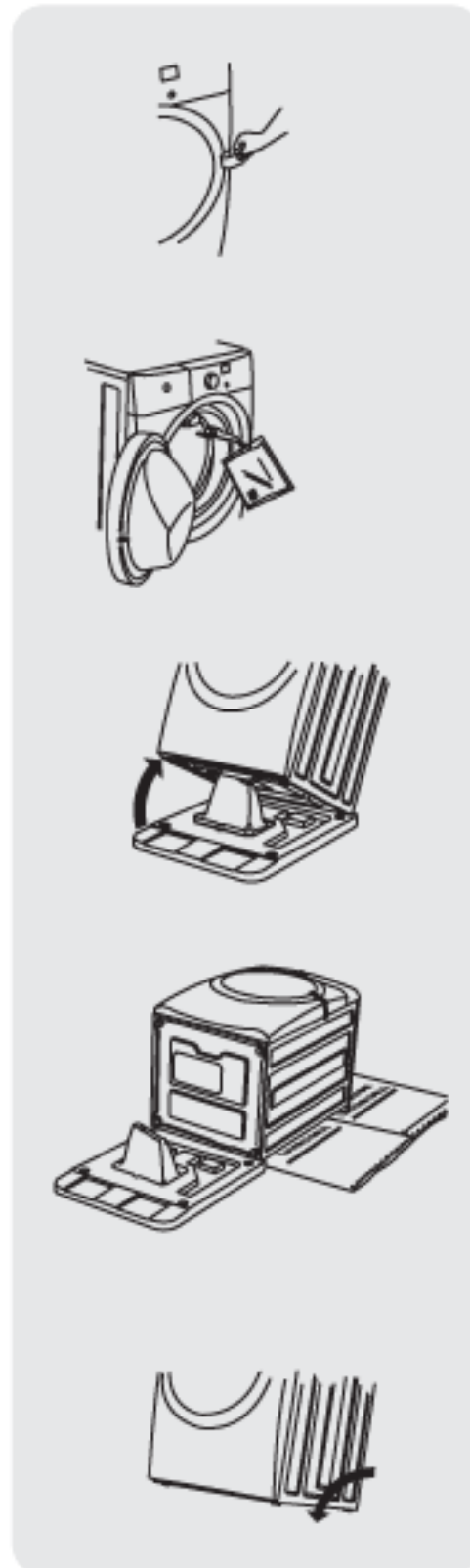

Removing shipping hardware

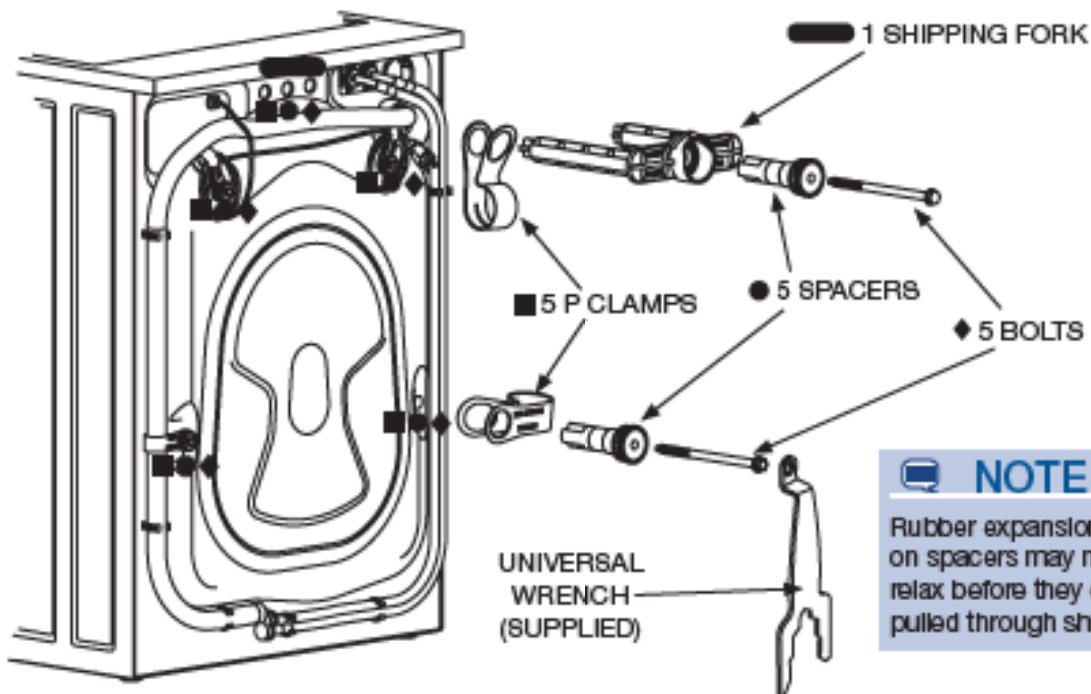

NOTE

Rubber expansion material on spacers may need time to relax before they can be easily pulled through shipping hole.

Remove all of the following:

1 SHIPPING FORK ● 5 SPACERS

5 P CLAMPS ◆ 5 BOLTS

IMPORTANT

Save all shipping bolts and spacers for future use. If the washer is to be transported at a later date, the shipping hardware must be reinstalled to help prevent shipping damage.

Installing hole plugs

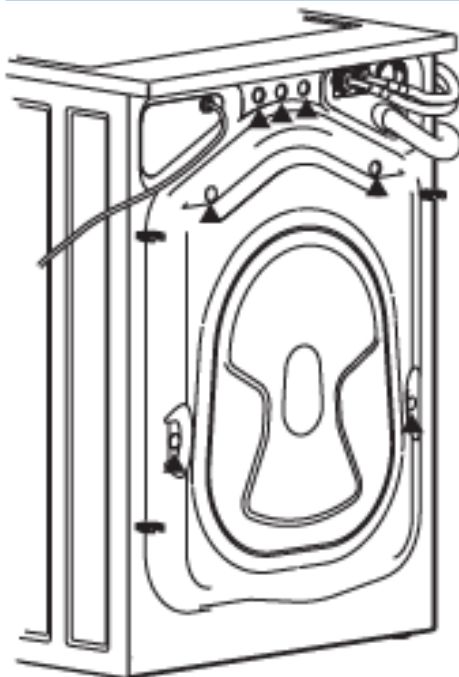

Locate 7 hole plugs in the small bag supplied with washer instruction guides. Insert them in the holes in washer back panel.



Leveling your washer

Excessive noise and vibration can be prevented by properly leveling the washer.

1. For free standing installation and with the washer within 4 feet (1 m) of its final location, place a level on top of the washer.
2. Use the universal wrench to adjust the leveling legs so the washer is level front-to-rear and side-to-side, and stable corner-to-corner.
3. Press down on alternate corners and sides and feel for the slightest movement. Adjust the appropriate leg(s) so the washer sits solidly on the floor on ALL four legs. Keep the leveling leg extension at a minimum for best performance of the washer.



NOTE

For pedestal installations, see additional installation instructions included with the pedestal.

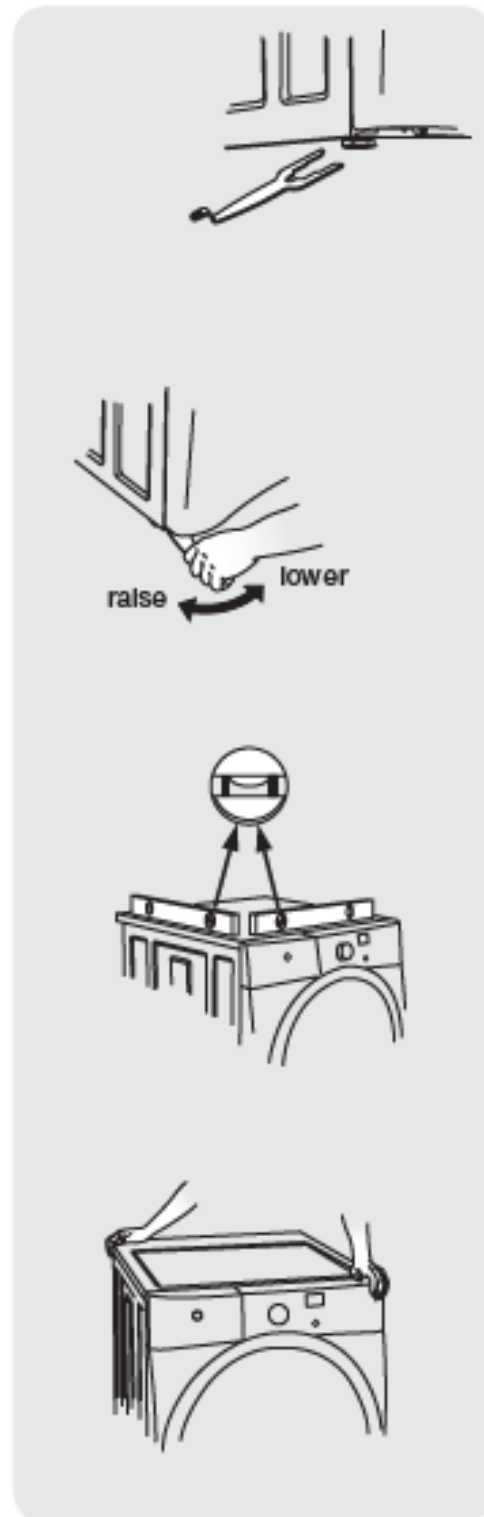

Connecting inlet water

1. Run some water from the hot and cold faucets to flush the water lines and remove particles that might clog the water valve screens and to determine which faucet is hot and which is cold supply.
2. Look in the end of each water supply inlet hose and verify that the rubber washers are in place.



NOTE

HOT and COLD water inlet hoses are color coded for identification. The HOT inlet hose is marked with a RED band and the COLD inlet hose is marked with a BLUE band.

3. Connect the HOT inlet hose to the HOT water supply and the COLD inlet hose to the COLD water supply. Tighten by hand until snug.
4. Tighten each supply connection another 2/3 turn with pliers.
5. Turn on the water and check for leaks.

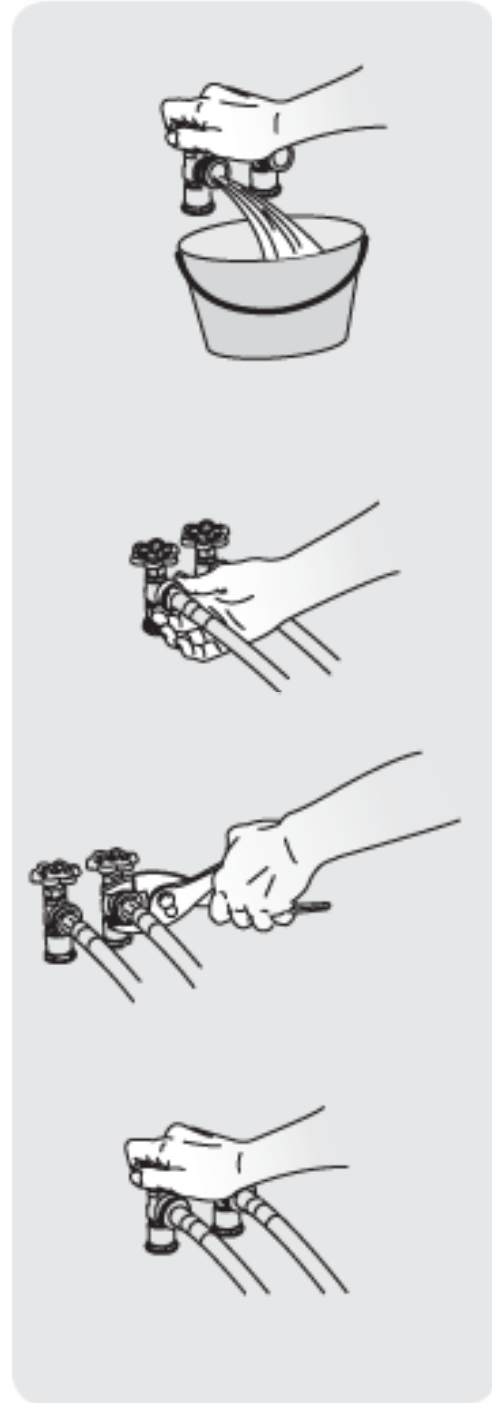

Connecting drain and electrical

1. Snap one end of the drain hose hanger (shipped in washer drum) onto the drain hose. Continue wrapping it around the hanger and snap it in place.
2. Place the hook end of the drain hose in the drain opening. Secure the drain hose with the cable tie (provided in the enclosure package) to the stand-pipe, inlet hose, laundry tub, etc. so the hose does not pull out from the force of the water.

▶ IMPORTANT

Check to ensure the power is off at a circuit breaker/fuse box before plugging the power cord into an outlet.

3. Plug the power cord into a grounded outlet.

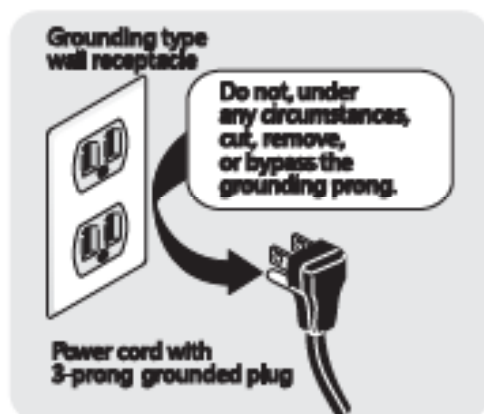

4. Turn on the power at a circuit breaker/fuse box.
5. Carefully slide the washer to its final position. Recheck for level and rock corners for stability. Remove and discard door tape.
6. Read the *Use & Care Guide* provided with the washer. It contains valuable and helpful information that will save you time and money.
7. See the next page about performing a brief, helpful "Installation Cycle" on your new washer.
8. If you have any questions during initial operation, please review the "Service Prevention Checklist" in your *Use & Care Guide* before calling for service.
9. Place these instructions in a location near the washer for future reference.

☰ NOTE

A wiring diagram and technical data sheet are located under the washer top panel, on top of the detergent dispenser housing.

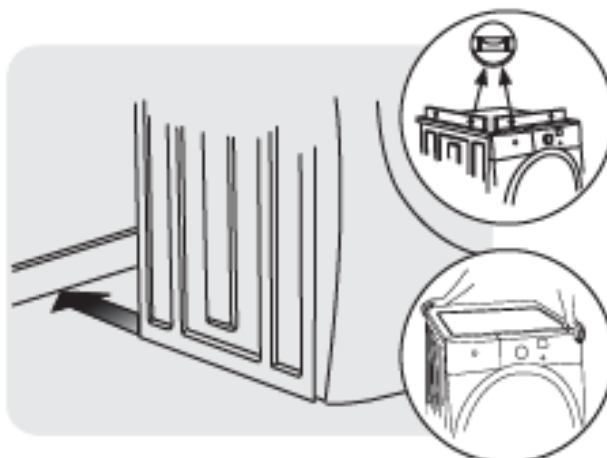
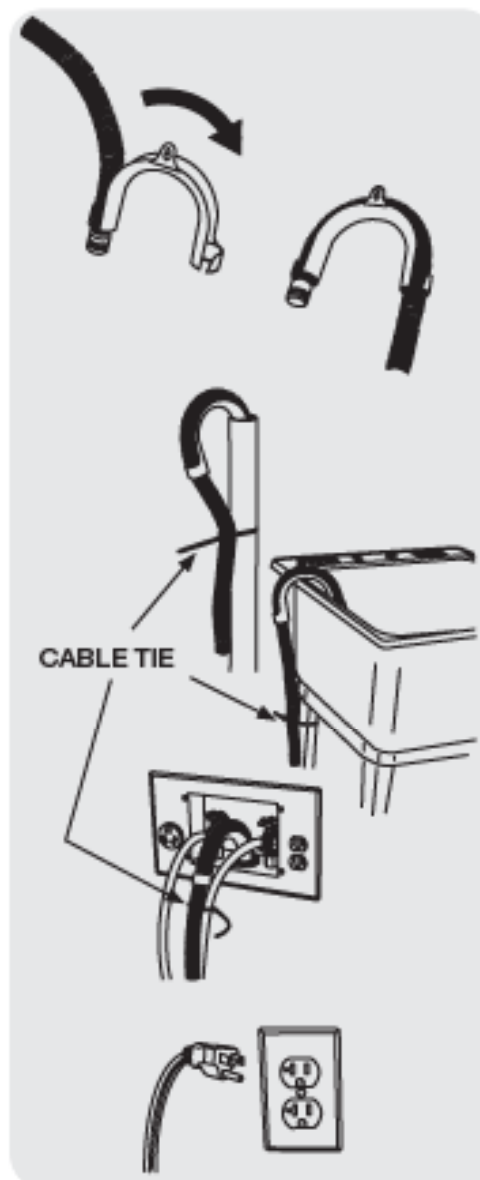

12 Installation Instructions

Performing Installation Cycle

If your washer has this console:



1. Empty washer's drum and close door.
2. After you plug in the washer the first time: wake up the washer by pressing any button, rotate cycle knob to **hand wash** cycle, press the **start** button and then the **cancel** button.
3. Wake up the washer again by pressing any button, then immediately and simultaneously press and hold both the **eco friendly** and **my favorite** buttons for 5 seconds, or until the LCD display changes.
4. The LCD window will display **INSTAL CYCLE** and show estimated time of cycle completion. Press the **start** button. The Installation Cycle will automatically test for if water has been turned on. At cycle completion, the LCD window may display **INSTAL PASS!**, meaning your new washer is properly installed and ready for use. If it prompts an action such as **NO WATER**, **CHECK HOSES** or **CALL SERVICE 877 435 3287**, review the installation steps and make the necessary corrections before you attempt to use the washer.
5. Your washer will exit the Installation Cycle and return to normal operation the next time you wake it up.

NOTE

Washer will stay awake for 3 minutes after the Installation Cycle. If you wish to immediately run the washer through a washing cycle, press the **cancel** button to put the unit to sleep and then rewake it immediately to continue the normal operating mode.

6. Please read the *Use & Care Guide* and enjoy your new premium washer!

If your washer has this console:



1. After you plug in the washer the first time: wake up the washer by pressing any button and then follow the prompts on the LCD User Interface, including language selection.
2. The Installation Cycle will automatically test for, and if water has been turned on. At cycle completion, the LCD window may display **INSTAL PASS!**, meaning your new washer is properly installed and ready for use. If it prompts an action such as **NO WATER**, **CHECK HOSES** or **CALL SERVICE 877 435 3287**, review the installation steps and make the necessary corrections before you attempt to use the washer.
3. Your washer will exit the Installation Cycle and return to normal operation the next time you wake it up.

NOTE

Washer will stay awake for 3 minutes after the Installation Cycle. If you wish to immediately run the washer through a washing cycle, press the **cancel** button to put the unit to sleep and then rewake it immediately to continue the normal operating mode.

4. Please read the *Use & Care Guide* and enjoy your new premium washer!

Preparing to reverse door swing

- 1 Be sure you have adequate swing area before reversing door.
- 2 You will need a screw driver with a #2 square bit.
- 3 Protect flat work surface, such as top of washer or floor near washer, with a soft cloth or towel.
- 4 Be sure washer is unplugged from power source!

Tools needed:



Screwdrivers with
#2 square &
straight bit

WARNING

ELECTRICAL SHOCK HAZARD

Failure to disconnect power source before servicing could result in personal injury or even death.

Removing door and hardware

A) Removing Trim Ring

- 1 Open the door to a 90 degree angle.
- 2 Remove and save the trim plug and long, course-thread, panhead screw.

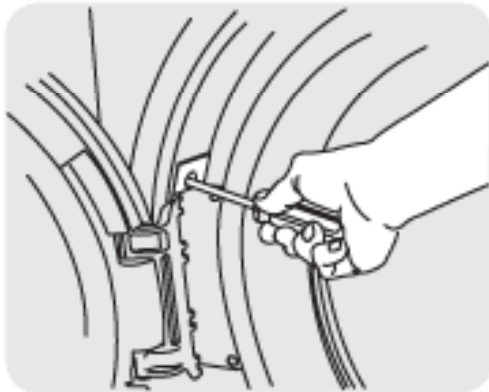

- 3 Close the door.
- 4 Rotate the door trim approximately $\frac{3}{4}$ " counter-clockwise and pull it away from the front of the door.

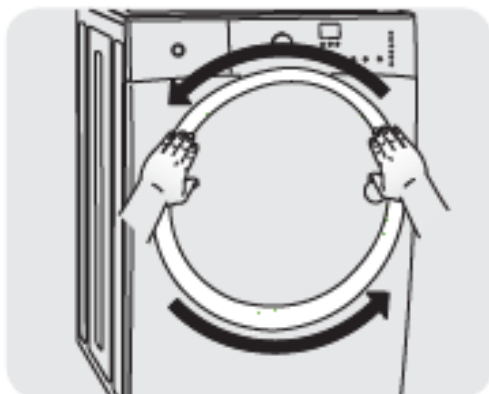

B) Removing Door from Hinge

- 1 Reopen door to 90 degree angle.
- 2 Remove 4 long, course-thread, counter-sunk hinge screws from door.

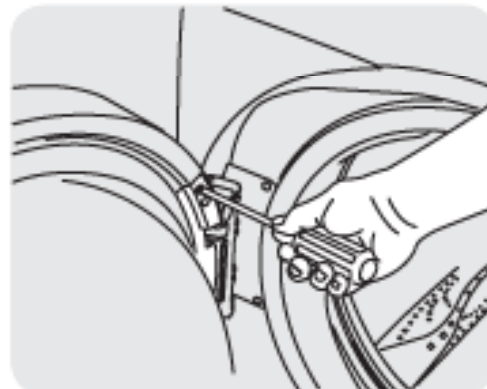

- 3 While supporting the weight of the door with both hands, separate the door from the hinge.

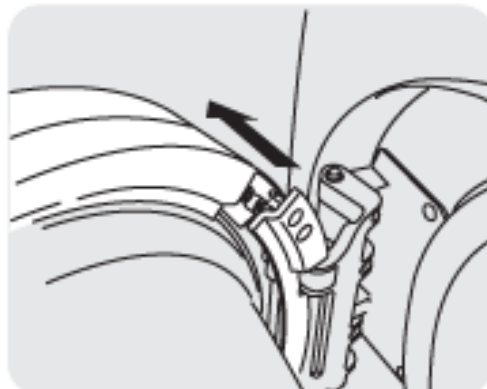

- 4 Gently place the door face down on a flat, covered work surface.

C) Removing Hinge from Front Panel

- 1 With the hinge in open position, remove 2 short, coarse-thread, panhead screws on hinge plate.

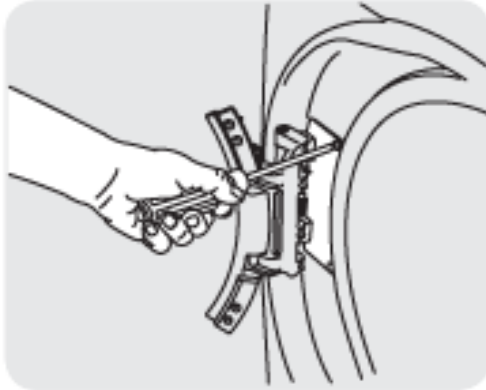

- 2 Remove 3 short, fine-thread, counter-sunk screws in hinge side.

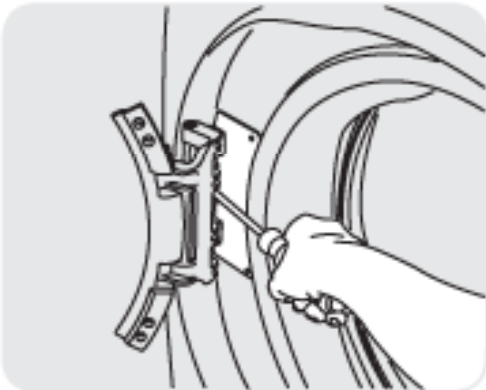

- 3 Slide the hinge toward the center of the front panel, and then pivot the hinge inward while slowly pulling it away from the front panel to expose the attached harness.
- 4 Lift up on the tab and the release harness from the retainer, allowing the harness to lay outside the front panel.

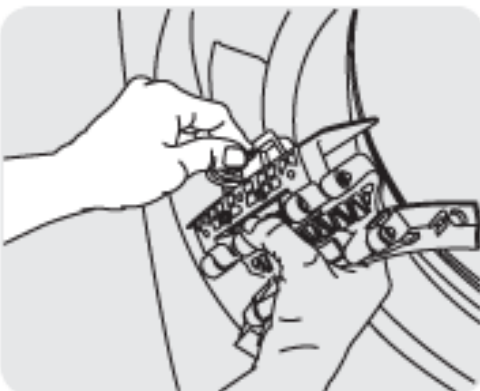

D) Removing Door Lock from Front Panel

- 1 Remove 2 short, coarse-thread, panhead screws from the door lock.

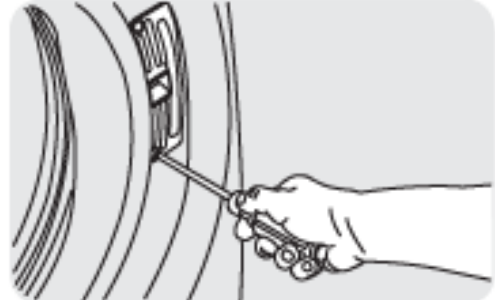

- 2 Slide the lock toward the outer edge of the front panel. Pivot the lock slightly outward while slowly pulling it through opening to expose the attached harness.

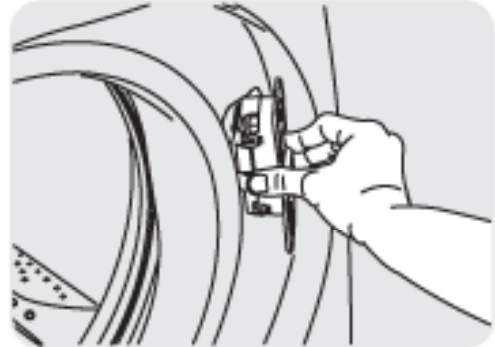

⚠ WARNING

ELECTRICAL SHOCK HAZARD
Failure to disconnect power source before servicing could result in personal injury or even death.

- 3 Release the harness from the terminal with the small lever on back of the lock. Separate the harness from the lock, allowing the harness to lay outside the front panel.

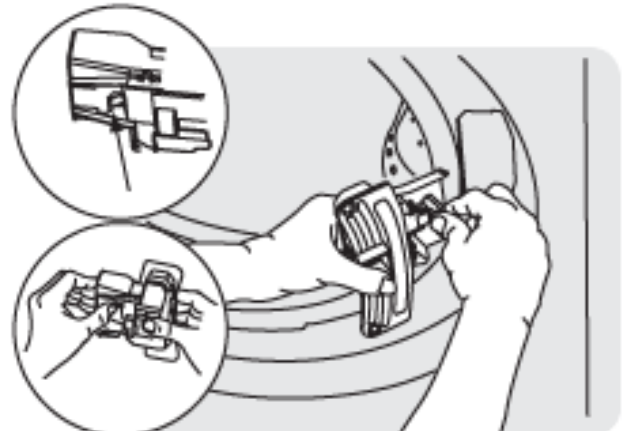

Reversing door and hardware

E) Reattaching Door Lock to Front Panel

- 1 Rotate the door lock and move it to the opposite opening.
- 2 Connect the harness to the door lock by inserting it in the terminal and firmly pushing it in place.

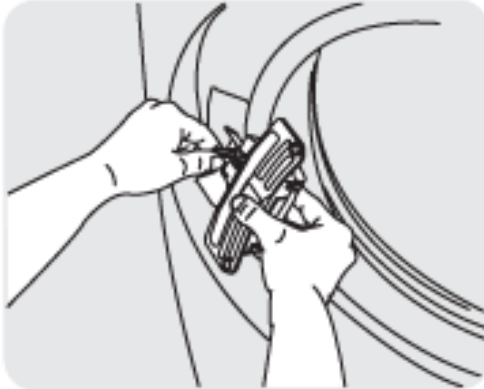

- 3 Insert the harness connection through the front panel first, and then pivot the lock until it is flush. Slide the lock toward the center of the front panel until the screw holes line up.

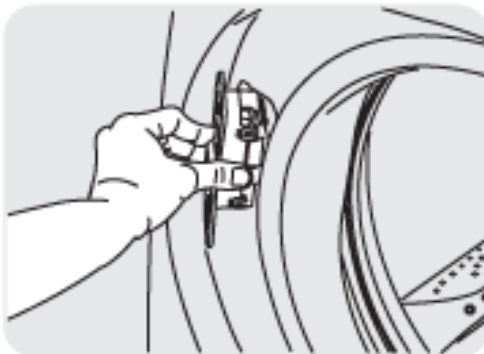

- 4 Secure the lock with 2 short, coarse-thread, panhead screws.

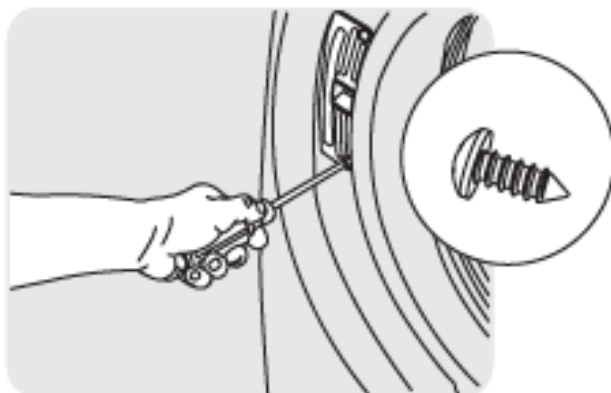

F) Reattaching Hinge to Front Panel

- 1 Rotate the hinge and move it to the opposite opening.
- 2 Connect the harness to the hinge retainer by inserting it in the retention terminal and gently pushing until you hear the fastening tab click.
- 3 Gently pull on the harness to be sure it is secure.

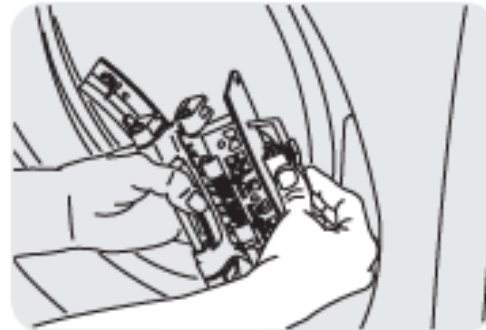

- 4 Use the side locating pins to align the hinge and install 1 short, fine-thread, counter-sunk screw in the center hole of hinge side.

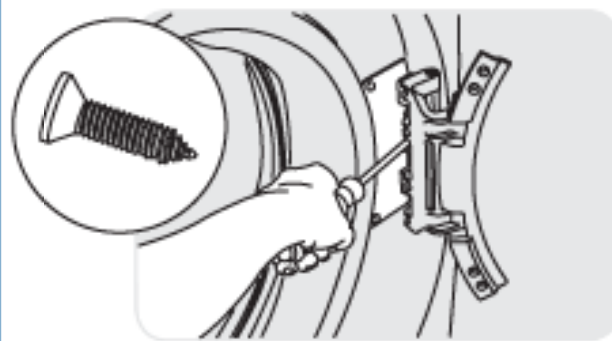

- 5 Install the other 2 short, fine-thread, counter-sunk screws in the upper and lower holes of hinge side.
- 6 Install 2 short, coarse-thread, panhead screws through hinge plate.

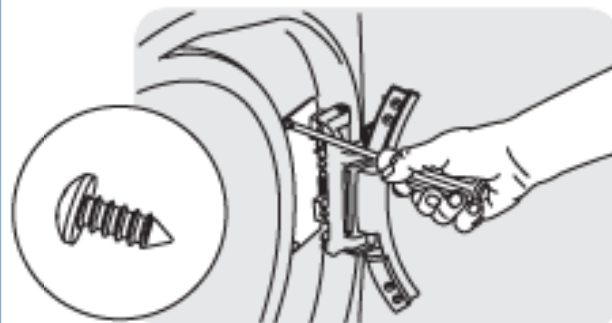

G) Removing Striker Plate

- 1 Remove 2 long, coarse-thread, counter-sunk screws and striker plate.

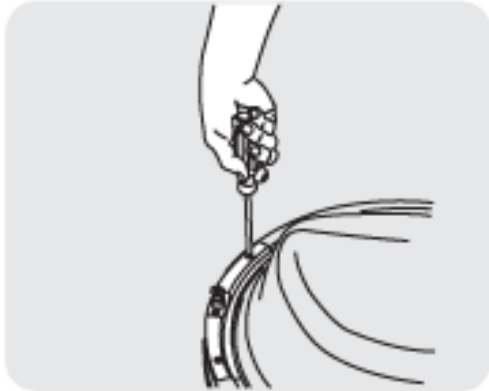

- 2 Set the striker plate to the side for later.

H) Removing Latch Indicator

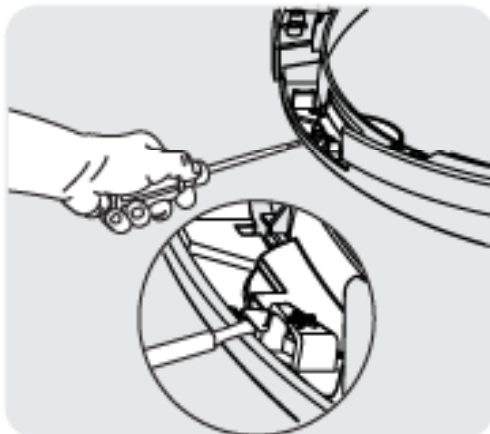

- 1 Insert flat blade screwdriver into open slot of latch indicator.
- 2 Gently pry upward to release tab.

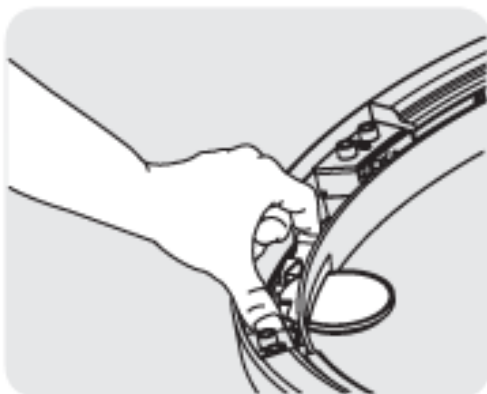

- 3 Pull the indicator out and set it aside.

I) Removing Hole Plug

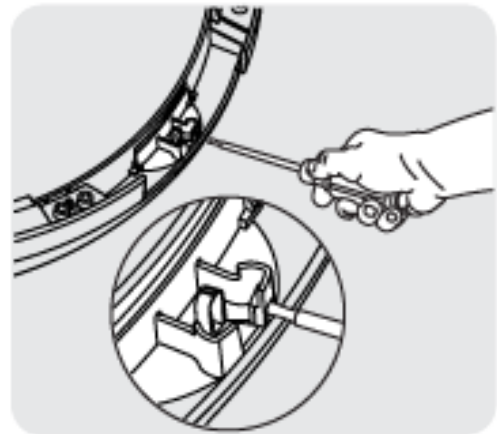

- 1 Insert flat blade screwdriver into open slot of hole plug.
- 2 Gently pry upward to release tab.

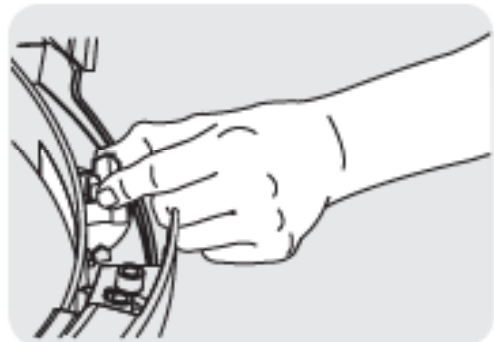

- 3 Pull the hole plug out and set it aside.

J) Reinserting Latch Indicator

- 1 Rotate the latch indicator and move it to the opposite hole in the door.

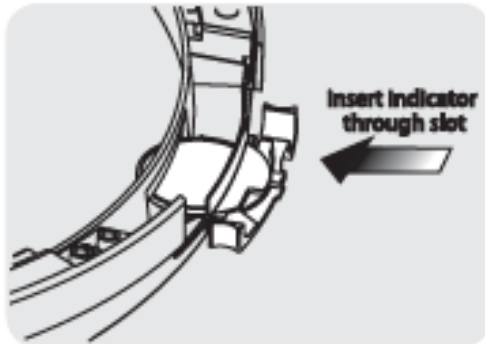

- 2 Firmly insert the two small tabs on either side of the latch indicator into the two slots on either side of the hole in the door.

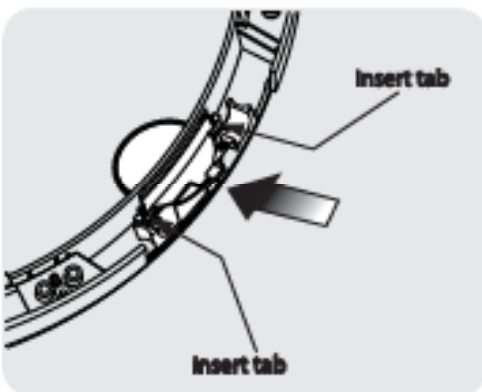

- 3 Firmly press downward on the indicator until the tab snaps in place.

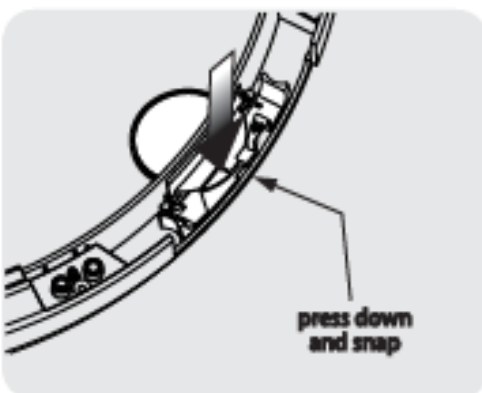

K) Reattaching Striker Plate

- 1 Rotate the striker plate and move it to the opposite side of door above the indicator.
- 2 Reattach with 2 long, coarse-thread, counter-sunk screws.

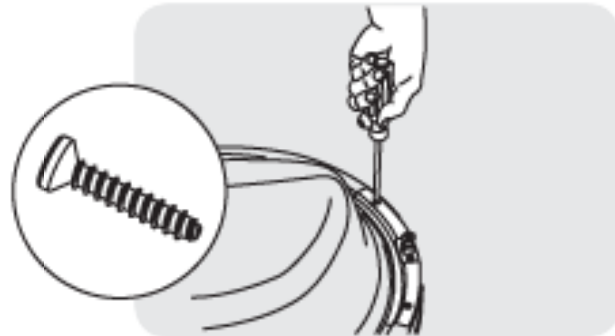

L) Reinserting Hole Plug

- 1 Rotate the hole plug and move it to the opposite hole in the door.
- 2 Firmly insert the two small tabs on either side of the hole plug into the two slots on either side of the hole in the door.

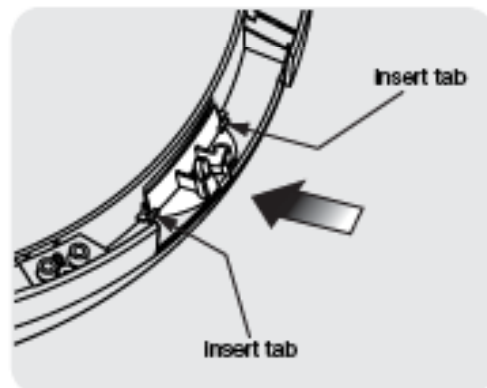

- 3 Firmly press downward on the hole plug until the tab snaps in place.



Reattaching door and hardware

M) Reattaching Door Assembly

- 1 Open the hinge to a 90 degree angle.
- 2 Install the door onto the hinge locating pins.

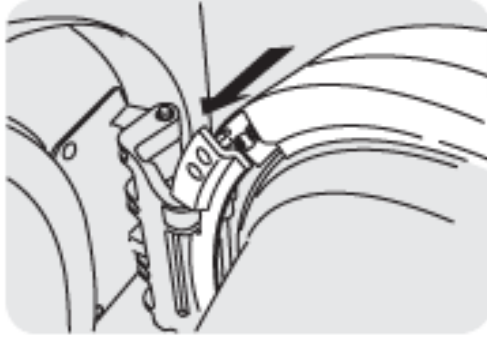

- 3 Secure the door with 4 long, coarse-thread, counter-sunk screws.

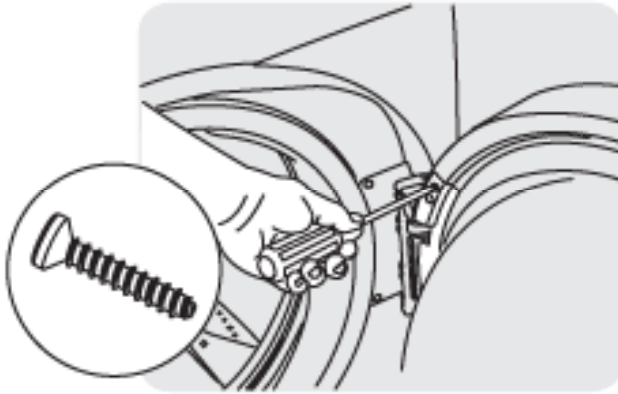

- 4 Close the door and test the operation of the latch.

N) Reversing Trim Ring

- 1 Trim ring orientation is marked on the back.
- 2 Remove the trim ring cover plate. To remove the cover plate from the right, pivot point is up. To remove the cover plate from the left, pivot point is down.

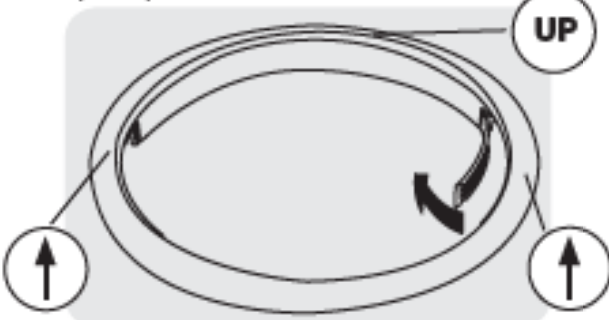

- 3 Rotate the trim ring cover plate and move it to the opposite opening in the trim and reinsert.

O) Reinstalling Trim Ring

- 1 Close the door.
- 2 Orient the trim so 12 position is approximately $\frac{3}{4}$ " to the left of top center. The opening in the trim ring should be on the hinge side.
- 3 Insert the trim ring in the slots and rotate it clockwise approximately $\frac{3}{4}$ ".

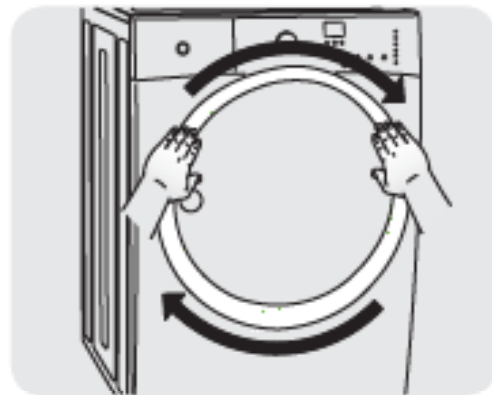

P) Reinstalling Trim Plug

- 1 Open the door to a 90 degree angle.
- 2 Install the trim plug with 1 long, coarse-thread, panhead screw.

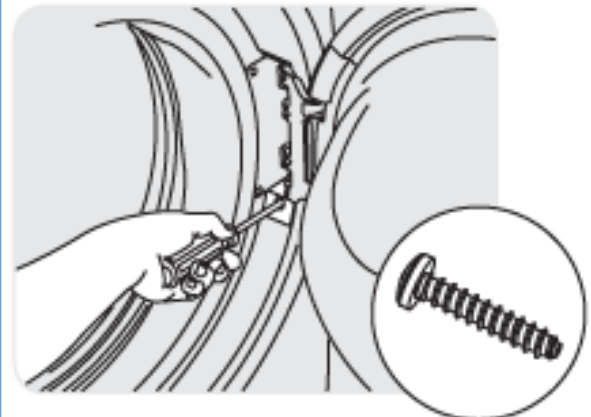

- Q) Plug in washer and continue operation.

Accessories

MATCHING STORAGE PEDESTAL

Island White Pedestal - P/N EPWD15IW

Mediterranean Blue - P/N EPWD15MB

Silver Sands Pedestal - P/N EPWD15SS

Turquoise Sky Pedestal - P/N EPWD15TS

A storage pedestal accessory, specifically designed for this washer may be used to elevate the dryer for ease of use. This pedestal will add about 15" (38.1 cm) to the height of your unit for a total height of 53" (134.62 cm).

DRYER STACKING KIT

P/N 134700400

A kit for stacking the matching dryer on top of this washer is available with the purchase of the matching dryer.

DRAIN HOSE EXTENSION KIT

P/N 137098000

In order to reach standpipe heights or distances beyond the reach of the drain hose supplied, order the DRAIN HOSE EXTENSION KIT.

MOBILE HOME INSTALLATION KIT

P/N 137067200

Installation in a mobile home requires the use of a MOBILE HOME INSTALLATION KIT.

UNIVERSAL APPLIANCE WRENCH

P/N 137019200

Your washer was supplied with a UNIVERSAL APPLIANCE WRENCH. If you desire another wrench, you may order one.

CAUTION

Failure to use accessories manufactured by (or approved by) the manufacturer could result in personal injury, property damage or damage to the washer.

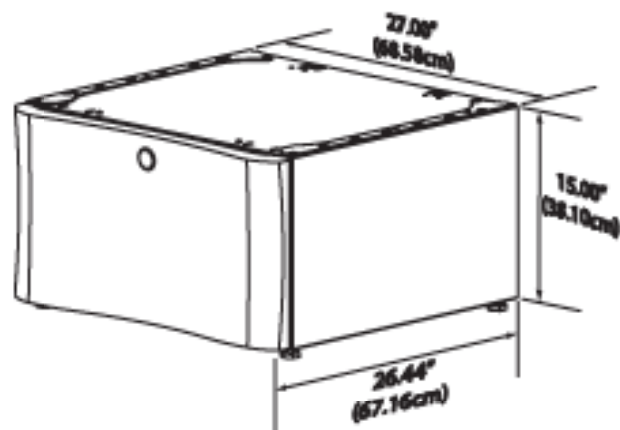

Replacement parts: 1-877-4ELECTROLUX (1-877-435-3287)

If replacements parts are needed for your washer, contact the source where you purchased your washer, call 1-877-4ELECTROLUX (1-877-435-3287), or visit our website, www.electroluxappliances.com, for the Electrolux Authorized Parts Distributor nearest you.

WARNING

ELECTRICAL HAZARD

Label all wires prior to disconnection when servicing controls. Wiring errors can cause improper and dangerous operation. Verify proper operation after servicing.