

Use & Care Guide

Over the Range Microwave Oven

Guía de Uso y Cuidado

Horno microondas sobre la estufa

Mode d'emploi et d'entretien

Four à micro-ondes au dessus de la cuisinière



 **Electrolux**

Please read and save this guide

Thank you for choosing **Electrolux**, the new premium brand in home appliances. This Use & Care Guide is part of our commitment to customer satisfaction and product quality throughout the service life of your new appliance.

We view your purchase as the beginning of a relationship. To ensure our ability to continue serving you, please use this page to record important product information.

Keep a record for quick reference

Purchase date

Electrolux model number

Electrolux serial number (see picture for location)

NOTE

Registering your product with Electrolux enhances our ability to serve you. You can register online at www.electroluxappliances.com or by dropping your Product Registration Card in the mail.

Questions?

For toll-free telephone support in the U.S. and Canada:
1-877-4ELECTROLUX (1-877-435-3287)

For online support and Internet production information visit <http://www.electroluxappliances.com>

PRECAUTIONS TO AVOID POSSIBLE EXPOSURE TO EXCESSIVE MICROWAVE ENERGY

- (a) Do not attempt to operate this oven with the door open since open-door operation can result in harmful exposure to microwave energy. It is important not to defeat or tamper with the safety interlocks.
- (b) Do not place any object between the oven front face and the door or allow soil or cleaner residue to accumulate on sealing surfaces.
- (c) Do not operate the oven if it is damaged. It is particularly important that the oven door close properly and that there is no damage to the: (1) door (bent), (2) hinges and latches (broken or loosened), (3) door seals and sealing surfaces.
- (d) The oven should not be adjusted or repaired by anyone except properly qualified service personnel.

FINDING INFORMATION	2	SENSOR COOKING	16-17
PRECAUTIONS TO AVOID POSSIBLE EXPOSURE TO EXCESSIVE MICROWAVE ENERGY	2	Sensor Cook	16
TABLE OF CONTENTS	3	Sensor Cook Chart	17
IMPORTANT SAFETY INSTRUCTIONS	4-5	Sensor Reheat	17
GROUNDING INSTRUCTIONS	6	ONE TOUCH COOK	18-20
UNPACKING AND EXAMING YOUR OVEN	6	Popcorn.....	18
INFORMATION YOU NEED TO KNOW	7-10	Veggies	18
About Your Oven	7	Snacks.....	19
About Microwave Cooking.....	7	Snacks Chart.....	19
About Safety	8	Melt/Soften.....	20
About Children and the Microwave.....	8	Melt/Soften Chart.....	20
About Food	9	Keep Warm.....	20
About Utensils and Coverings	10	AUTO DEFROST	21-24
PART NAMES	11	Convection	25-31
CONTROL PANEL	12	Convection Preheat.....	25
BEFORE OPERATING	13	Convection	26
To Set the Clock	13	Convection Guidelines.....	27-29
Stop/Clear	13	Fast Cook.....	30
MANUAL COOKING	13-15	Fast Cook Guidelines.....	31
Time Cook.....	13	CONVENIENT FEATURES	32-35
Interrupting Cooking	13	CLEANING AND CARE	36-38
Using One Touch Start	13	SERVICE CALL CHECK	39
Using Add 30 Sec.	14	SPECIFICATIONS	40
Setting Timed Cooking With Power Level.....	14	WARRANTY INFORMATIONS	41
Setting Two-Stage Cooking.....	14		
To Set Power Level.....	15		
Using the Rack	15		

IMPORTANT SAFETY INSTRUCTIONS

When using electrical appliances basic safety precautions should be followed, including the following:



WARNING

To reduce the risk of burns, electric shock, fire, injury to persons or exposure to excessive microwave energy:

1. **Read all instructions before using the appliance.**
2. Read and follow the specific **“PRECAUTIONS TO AVOID POSSIBLE EXPOSURE TO EXCESSIVE MICROWAVE ENERGY”** on page 2.
3. This appliance must be grounded. Connect only to properly grounded outlet. See “Grounding Instructions” on page 6.
4. Install or locate this appliance only in accordance with the provided installation instructions.
5. Some products such as whole eggs and sealed containers—for example, closed glass jars—are able to explode and should not be heated in this oven.
6. Use this appliance only for its intended use as described in this manual. Do not use corrosive chemicals or vapors in this appliance. This type of oven is specifically designed to heat, cook or dry food. It is not designed for industrial or laboratory use.
7. As with any appliance, close supervision is necessary when used by children.
8. Do not operate this appliance if it has a damaged cord or plug, if it is not working properly or if it has been damaged or dropped.
9. This appliance should be serviced only by qualified service personnel. Contact nearest Electrolux Authorized Servicer for examination, repair or adjustment.
10. Do not cover or block any openings on the appliance.
11. Do not store or use this appliance outdoors. Do not use this product near water—for example, near a kitchen sink, in a wet basement, near a swimming pool, or similar locations.
12. Do not immerse cord or plug in water.
13. Keep cord away from heated surfaces.
14. Do not let cord hang over edge of table or counter.
15. See door surface cleaning instructions on page 22.
16. Do not mount over a sink.
17. Do not store anything directly on top of the appliance surface when the appliance is in operation.
18. To reduce the risk of fire in the oven cavity:
 - a. **Do not overcook food. Carefully attend to appliance when paper, plastic or other combustible materials are placed inside the oven to facilitate cooking.**
 - b. Remove wire twist-ties from paper or plastic bags before placing bag in oven.
 - c. **If materials inside the oven ignite, keep oven door closed, turn oven off and disconnect the power cord or shut off power at the fuse or circuit breaker panel.**
 - d. Do not use the cavity for storage purposes. Do not leave paper products, cooking utensils or food in the cavity when not in use.
19. Liquids, such as water, coffee or tea are able to be overheated beyond the boiling point without appearing to be boiling. Visible bubbling or boiling when the container is removed from the Microwave Oven is not always present. **THIS COULD RESULT IN VERY HOT LIQUIDS SUDDENLY BOILING OVER WHEN A SPOON OR OTHER UTENSIL IS INSERTED INTO THE LIQUID.**

To reduce the risk of injury to persons:

 - a. Do not overheat the liquid.
 - b. Stir the liquid both before and halfway through heating it.
 - c. Do not use straight-sided containers with narrow necks. Use a wide-mouthed container .
 - d. After heating, allow the container to stand in the Microwave Oven at least for 20 seconds before removing the container.
 - e. Use extreme care when inserting a spoon or other utensil into the container.
20. Clean ventilation openings and grease filters frequently—grease should not be allowed to accumulate on ventilation openings, louver or grease filters.
21. Use care when cleaning the louver and the grease filters. Corrosive cleaning agents, such as lye-based oven cleaners, may damage the louver and the grease filters.
22. When flaming food under the hood, turn the fan on.
23. This appliance is suitable for use above both gas and electric cooking equipment 36" wide or less.

SAVE THESE INSTRUCTIONS

24. When using the convection or combination cooking functions, both the outside and inside of the oven will become hot. Always use hot pads to remove containers of food and cooking accessories such as the oven shelf, round wire rack and glass tray.

25. Do not clean with metal scouring pads. Pieces can burn off the pad and touch electrical parts involving risk of electric shock.

26. *Thermometer*—Do not use regular cooking or oven thermometers when cooking by microwave or combination. The metal and mercury in these thermometers could cause *arcing* and possible damage to the oven. Do not use a thermometer in food you are microwaving unless the thermometer is designed or recommended for use in the microwave oven.



WARNING

If you see arcing, press the **Stop/Clear** button and correct the problem.

ARCING

Arcing is the microwave term for sparks in the oven. Arcing is caused by:

- The metal shelf not installed correctly so it touches the microwave wall.
- Metal or foil touching the side of the oven.
- Foil not molded to food (upturned edges act like antennas).
- Metal, such as twist-ties, poultry pins, or gold-rimmed dishes, in the microwave.
- Recycled paper towels containing small metal pieces being used in the microwave.

Federal Communications Commission Radio Frequency Interference Statement (U.S.A. Only)

This equipment generates and uses ISM frequency energy and if not installed and used properly, that is in strict accordance with the manufacturer's instructions, may cause interference to radio and television reception. It has been type tested and found to comply with limits for ISM Equipment pursuant to part 18 of FCC Rules, which are designed to provide reasonable protection against such interference in a residential installation.

However, there is no guarantee that interference will not occur in a particular installation. If this equipment does cause interference to radio or television reception, which can be determined by turning the equipment off and on, the user is encouraged to try to correct the interference by one or more of the following:

- Reorient the receiving antenna of the radio or television.
- Relocate the microwave oven with respect to the receiver.
- Move the microwave oven away from the receiver.
- Plug the microwave oven into a different outlet so that the microwave oven and the receiver are on different branch circuits.

The manufacturer is not responsible for any radio or television interference caused by unauthorized modification to this microwave oven. It is the responsibility of the user to correct such interference.

6 GROUNDING INSTRUCTIONS

This appliance must be grounded. This oven is equipped with a cord having a grounding wire with a grounding plug. It must be plugged into a wall receptacle that is properly installed and grounded in accordance with the National Electrical Code and local codes and ordinances. In the event of an electrical short circuit, grounding reduces risk of electric shock by providing an escape wire for the electric current.



WARNING

Improper use of the grounding plug can result in a risk of electric shock.

Electrical Requirements

The oven is equipped with a 3-prong grounding plug. DO NOT UNDER ANY CIRCUMSTANCES CUT OR REMOVE THE GROUNDING PIN FROM THE PLUG.

DO NOT USE AN EXTENSION CORD.

If the power supply cord is too short, have a qualified electrician or serviceman install an outlet near the appliance.

The Power Supply Cord and plug must be connected to a separate 120 Volt AC, 60 Hz, 15 Amp, or more branch circuit, single grounded receptacle. The receptacle should be located inside the cabinet directly above the Microwave Oven mounting location as shown in Figure 1.

NOTES:

1. If you have any questions about the grounding or electrical instructions, consult a qualified electrician or service person.
2. Neither Electrolux nor the dealer can accept any liability for damage to the oven or personal injury resulting from failure to observe the correct electrical connection procedures.

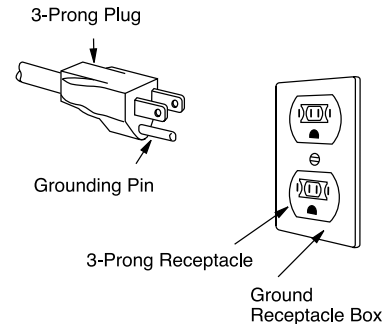
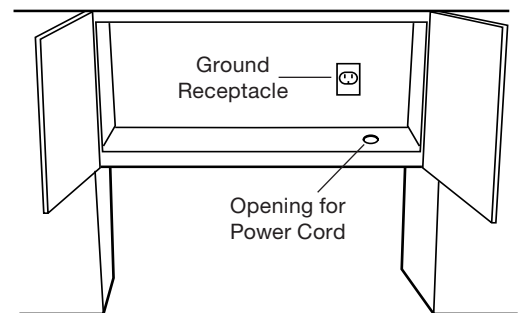

Figure 1



UNPACKING AND EXAMING YOUR OVEN

Open the bottom of the carton, bend the carton flaps back and tilt the oven over to rest on plasticfoam pad. Lift carton off oven and remove all packing materials, WALL and TOP CABINET TEMPLATES. SAVE THE CARTON AS IT MAY MAKE INSTALLATION EASIER.

1. Remove the feature sticker from the outside of the door, if there is one.
2. Check to see that there is a WALL TEMPLATE and TOP CABINET TEMPLATE. Read enclosures and SAVE the Use and Care Guide.

Check the oven for any damage, such as misaligned or bent door, damaged door seals and sealing surfaces, broken or loose door hinges and latches and dents inside the cavity or on the door. If there is any damage, do not operate the oven and contact your dealer or ELECTROLUX AUTHORIZED SERVICER. See Installation Instructions for more details.

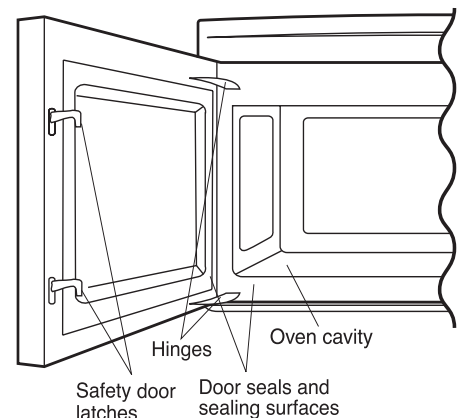

About Your Oven

This Use and Care Guide is valuable: read it carefully and always save it for reference.

NEVER use the oven without the turntable and support nor turn the turntable over so that a large dish could be placed in the oven. The turntable will turn both clockwise and counterclockwise.

ALWAYS have food in the Microwave Oven when it is on to absorb the microwave energy.

When using the oven at power levels below 100%, you may hear the magnetron cycling on and off. It is normal for the exterior of the oven to be warm to the touch when cooking or reheating.

Condensation is a normal part of microwave cooking. Room humidity and the moisture in food will influence the amount of moisture that condenses in the oven. Generally, covered foods will not cause as much condensation as uncovered ones. Ventilation openings must not be blocked.

The Microwave Oven is for food preparation only. It should not be used to dry clothes or newspapers.

Your Microwave Oven is rated 1050 watts by using the IEC Test Procedure. In using recipes or package directions, check food a minute or two before the minimum time and add time accordingly.

About Microwave Cooking

- Arrange food carefully. Place thickest areas towards outside of dish.
- Watch cooking time. Cook for the shortest amount of time indicated and add more as needed. Food severely overcooked can smoke or ignite.
- Cover foods while cooking. Check recipe or cookbook for suggestions: paper towels, wax paper, microwave plastic wrap or a lid. Covers prevent spattering and help foods to cook evenly.
- Shield with small flat pieces of aluminum foil any thin areas of meat or poultry to prevent overcooking before dense, thick areas are cooked thoroughly.
- Stir foods from outside to center of dish once or twice during cooking, if possible.
- Turn foods over once during microwaving to speed cooking of such foods as chicken and hamburgers. Large items like roasts must be turned over at least once.
- Rearrange foods such as meatballs halfway through cooking both from top to bottom and from the center of the dish to the outside.
- Add standing time. Remove food from oven and stir, if possible. Cover for standing time which allows the food to finish cooking without overcooking.
- Check for doneness. Look for signs indicating that cooking temperatures have been reached.
Doneness signs include:
 - Food steams throughout, not just at edge.
 - Center bottom of dish is very hot to the touch.
 - Poultry thigh joints move easily.
 - Meat and poultry show no pinkness.
 - Fish is opaque and flakes easily with a fork.

About Safety

- Check foods to see that they are cooked to the United States Department of Agriculture's recommended temperatures.

Temp	Food
145°F (63°C)	For beef, lamb or veal cut into steaks, chops or roasts MEDIUM RARE
160°F (71°C)	For fresh pork, ground meat, fish, seafood, egg dishes, frozen prepared food and beef, lamb or veal cut into steaks, chops or roasts cooked to MEDIUM
165°F (74°C)	For leftover, ready-to-reheat refrigerated, deli and carry out "fresh" food, whole chicken or turkey, chicken or turkey breasts and ground poultry used in chicken or turkey burgers, boneless white poultry. NOTE: Do not cook whole, stuffed poultry. Cook stuffing separately to 165°F.

To test for doneness, insert a meat thermometer in a thick or dense area away from fat or bone. NEVER leave the thermometer in the food during cooking, unless it is approved for microwave use.

- ALWAYS use potholders to prevent burns when handling utensils that are in contact with hot food. Enough heat from the food can transfer through utensils to cause skin burns.
- Avoid steam burns by directing steam away from the face and hands. Slowly lift the farthest edge of a dish's covering and carefully open popcorn and oven cooking bags away from the face.
- Stay near the oven while it's in use and check cooking progress frequently so that there is no chance of overcooking food.
- NEVER use the cavity for storing cookbooks or other items.
- Select, store and handle food carefully to preserve its high quality and minimize the spread of foodborne bacteria.
- Keep waveguide cover clean. Food residue can cause arcing and/or fires.
- Use care when removing items from the oven so that the utensil, your clothes or accessories do not touch the safety door latches.
- Keep aluminum foil used for shielding at least 1 inch away from walls, ceiling and door.

About Children and the Microwave

Children below the age of 7 should use the microwave oven with a supervising person very near to them. Between the ages of 7 and 12, the supervising person should be in the same room.

The child must be able to reach the oven comfortably; if not, he/she should stand on a sturdy stool.

At no time should anyone be allowed to lean or swing on the oven door.

Children should be taught all safety precautions: use potholders, remove coverings carefully, pay special attention to packages that crisp food because they may be extra hot.

Don't assume that because a child has mastered one cooking skill he/she can cook everything.

Children need to learn that the microwave oven is not a toy. See page 32 for Child Lock feature.

About Food

Food	Do	Don't
Eggs, sausages, nuts, seeds, fruits & vegetables	<ul style="list-style-type: none"> • Puncture egg yolks before cooking to prevent "explosion". • Pierce skins of potatoes, apples, squash, hot dogs and sausages so that steam escapes. 	<ul style="list-style-type: none"> • Cook eggs in shells. • Reheat whole eggs. • Dry nuts or seeds in shells.
Popcorn	<ul style="list-style-type: none"> • Use specially bagged popcorn for microwave cooking. • Listen while popping corn for the popping to slow to 1 or 2 seconds or use special popcorn pad. 	<ul style="list-style-type: none"> • Pop popcorn in regular brown bags or glass bowls. • Exceed maximum time on popcorn package.
Baby food	<ul style="list-style-type: none"> • Transfer baby food to small dish and heat carefully, stirring often. Check temperature before serving. • Put nipples on bottles after heating and shake thoroughly. "Wrist" test before feeding. 	<ul style="list-style-type: none"> • Heat disposable bottles. • Heat bottles with nipples on. • Heat baby food in original jars.
General	<ul style="list-style-type: none"> • Cut baked goods with filling after heating to release steam and avoid burns. • Stir liquids briskly before and after heating to avoid "eruption". • Use deep bowl, when cooking liquids or cereals, to prevent boilovers. 	<ul style="list-style-type: none"> • Heat or cook in closed glass jars or air tight containers. • Can in the microwave as harmful bacteria may not be destroyed. • Deep fat fry. • Dry wood, gourds, herbs or wet papers.

About Utensils and Coverings

It is not necessary to buy all new cookware. Many pieces already in your kitchen can be used successfully in your new Over the Range Microwave Oven. Make sure the utensil does not touch the interior walls during cooking.

Use these utensils for safe microwave cooking and reheating:

- glass ceramic (Pyroceram[®]), such as Corningware[®].
- heat-resistant glass (Pyrex[®])
- microwave-safe plastics
- paper plates
- microwave-safe pottery, stoneware and porcelain
- browning dish (Do not exceed recommended preheating time. Follow manufacturer's directions.)

These items can be used for short time reheating of foods that have little fat or sugar in them:

- wood, straw, wicker

DO NOT USE

- metal pans and bakeware
- dishes with metallic trim
- non-heat-resistant glass
- non-microwave-safe plastics (margarine tubs)
- recycled paper products
- brown paper bags
- food storage bags
- metal twist-ties

Should you wish to check if a dish is safe for microwaving, place the empty dish in the oven and microwave on HIGH for 30 seconds. A dish which becomes very hot should not be used.

The following coverings are ideal:

- Paper towels are good for covering foods for reheating and absorbing fat while cooking bacon.
- Wax paper can be used for cooking and reheating.
- Plastic wrap that is specially marked for microwave use can be used for cooking and reheating. DO NOT allow plastic wrap to touch food. Vent so steam can escape.
- Lids that are microwave-safe are a good choice because heat is kept near the food to hasten cooking.
- Oven cooking bags are good for large meats or foods that need tenderizing. DO NOT use metal twist ties. Remember to slit bag so steam can escape.

How to use aluminum foil in your Over the Range Microwave Oven:

- Small flat pieces of aluminum foil placed smoothly on the food can be used to shield areas that are either defrosting or cooking too quickly.
- Foil should not come closer than one inch to any surface of the oven.

Should you have questions about utensils or coverings, check a good microwave cookbook or follow recipe suggestions.

Accessories

There are many microwave accessories available for purchase. Evaluate carefully before you purchase so that they meet your needs. A microwave-safe thermometer will assist you in determining correct doneness and assure you that foods have been cooked to safe temperatures. Electrolux is not responsible for any damage to the oven when accessories are used.

MICROWAVE OVEN FEATURES

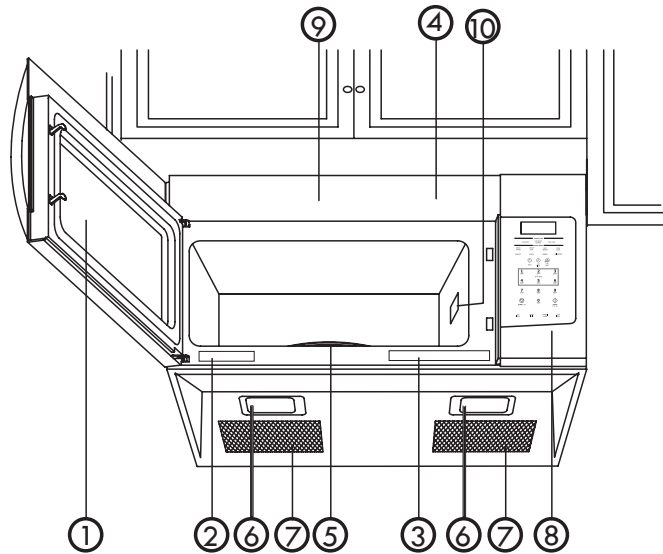

The microwave oven is designed to make your cooking experience as enjoyable and productive as possible. To get you up and running quickly, the following is a list of the oven's basic features:

1. **Metal Shielded Window:** The shield prevents microwaves from escaping. It is designed as a screen to allow you to view food as it cooks.
2. **Model and Serial Number Plate**
3. **Cooking Guide label**

4. Vent Top

5. Glass Turntable:

The turntable reverses rotation each time the microwave oven door is opened and closed. This helps cook food evenly. Do not operate the microwave oven without the turntable in place.

To Install:

1. Place the support on the oven cavity bottom.
2. Place the glass turntable on the support. Fit the raised, curved lines in the center of the turntable bottom between the three spokes of the hub. The rollers on the support should fit inside the turntable bottom ridge.

6. Cooktop Light

7. Grease Filters:

 See "Caring for the Filters" section.

8. Control Panel:

 Touch the pads on this panel to perform all functions.

9. Charcoal Filter:(behind Vent Top):

See "Caring for the Filters" section.

NOTE: Not all models come with a charcoal filter.

10. Waveguide Cover: DO NOT REMOVE.

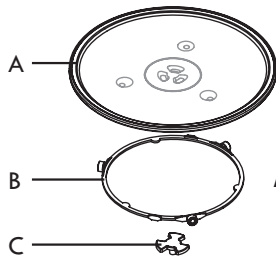

- A. Glass Turntable
- B. Support
- C. Hub

CONTROL PANEL FEATURES

Your microwave oven control panel lets you select the desired cooking function quickly and easily. All you have to do is touch the necessary Command Pad. The following is a list of all the Command and Number Pads located on the control panel.

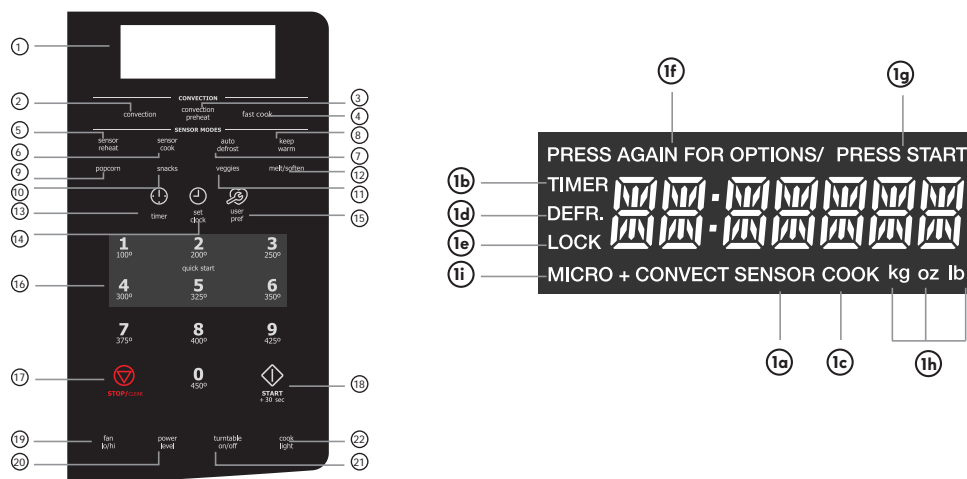

- 1. Display:** The display includes a clock and indicators that show the time of day, cooking time settings, cook powers, Fast Cook, sensor, quantities, weights and cooking functions selected.
 - 1a. SENSOR:** Icon displayed when using sensor cook.
 - 1b. TIMER:** Icon displayed when timer is being set or running.
 - 1c. COOK:** Icon displayed when starting microwave cooking.
 - 1d. DEFR:** Icon displayed when defrosting food
 - 1e. LOCK:** Icon displayed in control lock.
 - 1f. PRESS AGAIN FOR OPTIONS:** Icon displayed when additional options are available.
 - 1g. PRESS START:** Icon displayed when a valid function can be started.
 - 1h. kg,oz,lb:** Icon displayed when choosing the weight.
 - 1i. MICRO+CONVECT:** Icon displayed when using Fast Cook.
- 2. Convection:** Touch this pad when setting a convection bake or roast.
- 3. Convection Preheat:** Touch this pad when setting a convection bake or roast with preheating.
- 4. Fast Cook:** Touch this pad when setting a combination convection microwave and convection cook.
- 5. Sensor Reheat:** Touch this pad to reheat microwavable foods without entering a cook time or power.
- 6. Sensor Cook:** Touch this pad to cook microwavable foods without entering a cook time or power.
- 7. Auto Defrost:** Touch this pad, followed by Number Pads, to thaw frozen meat, poultry, fish by weight,
- 8. Keep Warm:** Touch this pad to keep food warm.
- 9. Popcorn:** Touch this pad to pop one of three bag sizes of popcorn without entering a cook time or power. Remove metal rack before cooking popcorn.
- 10. Snacks:** Touch this pad to select one of several preprogrammed items.
- 11. Veggies:** Touch this pad to cook Potatoes, fresh or frozen vegetables without entering a cook time or power.
- 12. Melt/Soften:** Touch this pad to melt or soften selected items.
- 13. Timer:** Touch this pad to set the kitchen timer.
- 14. Clock:** Touch this pad to enter the correct time of day.
- 15. User pref:** Touch this pad to set options.
- 16. Number Pads:** Touch number pads to enter time, cook power, quantity, weight.
- 17. STOP/CLEAR:** Touch this pad to erase an incorrect command, cancel a program during cooking, or to clear the Display.
- 18a. START :** Touch this pad to start or restart a function.
- 18b. Add 30 Sec. :** Touch this pad to cook for 30 seconds at 100% cook power, or to add extra time to your current cooking cycle.
- 19. Fan lo/hi:** Touch this pad to choose one of two vent speeds.
- 20. Power level:** Touch this pad after the cook time to set the amount of microwave energy released to cook the food.
- 21. Turntable On/Off:** Touch this pad to turn on or off the turntable during a cooking cycle.
- 22. Cook Light :** Touch this pad to turn the light on high, night (low) or off.

- Before operating your new oven make sure you read and understand this Use and Care Guide completely.
- The clock can be disabled when the microwave is first plugged in and the STOP key is selected.
To re-enable the clock follow clock instructions.

To Set the Clock

- Suppose you want to enter the correct time of day 10:59

Procedure	
Step	Touch
1. set clock	12:00 ENTER TIME
2. (1) (0) (5) (9)	10:59 <small>PRESS START</small>
3. 	10:59

NOTE

1. If you begin to enter in an incorrect time (e.g. 2:89) the 8 is an invalid digit and cannot be entered. Enter the correct time.
2. If you touch STOP while setting the clock, the display will show the last time of day set or a blank display if no time of day has been set.

STOP clear

Press the **STOP clear** to:

1. Erase if you make a mistake during programming.
2. Cancel timer and the signal after cooking.
3. Stop the oven temporarily during cooking.
4. Return the time of day to the display.
5. Cancel a program during cooking, press twice.

MANUAL COOKING

Time Cooking

Your Over the Range Microwave Oven can be programmed for 99 minutes 99 seconds (99 :99). Always enter the seconds after the minutes, even if they are both zeros.

- Suppose you want to cook for five minutes, 30 seconds at 100% power,

Procedure	
Step	Touch
1. (5) (3) (0)	5:30 <small>PRESS START</small>
2. 	5:30 <small>COOK</small> Time counting down

Interrupting Cooking

You can stop the oven during a cycle by opening the door. The oven stops heating and the fan turns off, but the light stays on.

To restart cooking, close the door and Touch  .

If you do not want to continue cooking, open the door and touch **STOP/CLEAR** .

Using One Touch Start

This is a time saving pad that will automatically start cooking 2 seconds after selected. Numeric key 1-6 can be touched for 1-6 minute automatic start cooking feature.



Procedure	
Step	Touch
1. (2)	2:00 <small>COOK</small> Time counting down

14 MANUAL COOKING

Using Add 30 Sec.

This is a time-saving pad. It is a simplified feature that lets you quickly set and start microwave cooking at 100% power.

- Suppose you want to cook for one minute.

Procedure	
Step	Touch
1. 	:30 _{COOK}
2. 	1:00 _{COOK} Time counting down

NOTE

Each time you touch ADD 30 SEC, it will add 30 seconds up to 99 minutes 99 seconds.

Setting Timed Cooking With Power Level

This feature lets you program a specific cook time and power. For best results, there are 10 power level settings in addition to HIGH (100%) power.

- Suppose you want to cook for five minutes, 30 seconds at 80% power.

Procedure	
Step	Touch
1. (5) (3) (0)	5:30 ^{PRESS START}
2. Power Level x 3	PL-80 ^{PRESS START}
3. 	5:30 _{COOK} Time counting down

NOTE

If you do not select a power level, the oven will automatically cook at HIGH (100%) power.

Setting Two-Stage Cooking

For best results, some recipes call for different power levels during a cook cycle. You can program your oven for two power level stages during the cooking cycle.

- Suppose you want to set a 2-stage cook cycle. The first stage is a 3 minute cook time at 80% cook power then a 7 minute cook time at 50% cook power.

Procedure	
Step	Touch
1. (3) (0) (0)	3:00 ^{PRESS START} To set a 3 minute cook time for first stage.
2. power level x 3	PL-80 ^{PRESS START}
3. (7) (0) (0)	7:00 ^{PRESS START} To set a 7 minute cook power for the second stage.
4. power level x 6	PL-50 ^{PRESS START}

NOTE

You can program a "0" power second stage for standing time inside the oven.

5. 	3:00 _{COOK} Time counting down
---	--

To Set Power Level

There are eleven preset power levels. Using lower power levels increases the cooking time which is recommended for foods such as cheese, milk and long slow cooking of meats. Consult cookbook or recipes for specific recommendations.

PRESS POWER LEVEL PAD NUMBER OF TIMES FOR DESIRED POWER	APPROXIMATE PERCENTAGE OF POWER	COMMON WORDS FOR POWER LEVELS
POWER LEVEL x 1	100%	High
POWER LEVEL x 2	90%	
POWER LEVEL x 3	80%	
POWER LEVEL x 4	70%	Medium High
POWER LEVEL x 5	60%	
POWER LEVEL x 6	50%	Medium
POWER LEVEL x 7	40%	
POWER LEVEL x 8	30%	Med Low/Defrost
POWER LEVEL x 9	20%	
POWER LEVEL x 10	10%	Low
POWER LEVEL x 11	0%	

Using the Rack

The rack allows several foods to be cooked or reheated at one time. However, for the best cooking and reheating, use Turntable ON function and cook with SENSOR COOKING or AUTO COOKING without the rack. When the rack is used, set time and power level manually. Allow plenty of space around and between the dishes. Pay close attention to the cooking and reheating progress. Reposition the foods and reverse them from the rack to turntable and/or stir them at least once during any cooking or reheating time. After cooking or reheating, stir if possible. Using a lower power level will assist in better cooking and reheating uniformity.

Avoid:

- Storing the rack in the microwave oven when not in use.
- Popping popcorn with the rack in the microwave oven.
- Using any browning dish on the rack.
- Using SENSOR COOKING and AUTO COOKING with the rack.
- Cooking directly on the rack—use microwave-safe cookware.

NOTE

Turntable on/off function can be used in Manual Operation. See page 35.

Manual Defrost

If the food that you wish to defrost is not listed on the Defrost chart or is above or below the limits in the Amount column on the Defrost chart (see page 22-23), you need to defrost manually.

You can defrost any frozen food, either raw or previously cooked, by using power level for 30%.

For either raw or previously cooked frozen food the rule of thumb is approximately 4 minutes per pound. For example, defrost 4 minutes for 1 pound of frozen spaghetti sauce.

Always stop the oven periodically to remove or separate the portions that are defrosted. If food is not defrosted at the end of the estimated defrosting time, program the oven in 1 minute increments on power level 30% until totally defrosted.

When using plastic containers from the freezer, defrost only long enough to remove from the plastic in order to place in a microwave-safe dish.

16 SENSOR COOKING

Sensor cooking has an electronic controlled sensor that detects the vapor (moisture and humidity) emitted from the food as it heats. The sensor adjusts the cooking times and power level for various foods and quantities automatically.

Using Sensor Settings:

1. Be sure the exterior of the cooking container and the interior of the oven are dry. Wipe off any moisture with a dry cloth or paper towel.
2. The oven works with foods at normal storage temperature. For example, popcorn would be at room temperature.
3. More or less food than the quantity listed in the chart should be cooked following the guidelines in any microwave cookbook.
4. During the first part of SENSOR COOKING, food name will appear in the display. Do not open the oven door or press the **STOP clear** pad during this part of the cycle. The measurement of vapor will be interrupted. When the sensor detects the vapor emitted from the food, remainder of cooking time will appear. Door may be opened when remaining cooking time appears in the display. At this time, you may stir or season food, as desired.
5. If the sensor does not detect vapor properly when popping popcorn, the oven will turn off, and the correct time of day will be displayed. If the sensor does not detect vapor properly when cooking other foods, AN ERROR CODE will be displayed, and the oven will turn off.
6. Check food for temperature after cooking. If additional time is needed, continue to cook manually.

Covering Foods:

Some foods cook better when covered.

1. Casserole lid.
2. Plastic wrap: Use plastic wrap recommended for microwave cooking. Cover dish loosely; allow approximately 1/2 inch to remain uncovered to allow steam to escape. Plastic wrap should not touch food.
3. Wax paper: Cover dish completely; fold excess wrap under dish to secure. If dish is wider than paper, overlap two pieces at least one inch to cover.

Be careful when removing any covering to allow steam to escape away from you.







NOTE for SENSOR COOKING

1. The final cooking result will vary according to the food condition (e.g. initial temperature, shape, quality). Check food for temperature after cooking. If additional time is needed, continue to cook manually.
2. Stay near the oven while it's in use and check cooking progress frequently so that there is no chance of overcooking food.
3. When SENSOR COOKING are selected Turntable On is automatically set for optimum cooking.

Sensor Cook

You can cook foods by pressing the **sensor cook** pad multiple times. You don't need to calculate cooking time or power level.

- Suppose you want to cook frozen breakfast .

Procedure	
Step	Touch
1. sensor cook	<small>PRESS AGAIN FOR OPTIONS/ PRESS START</small> 
2. sensor cook	<small>PRESS AGAIN FOR OPTIONS/ PRESS START</small> 
3. sensor cook	<small>PRESS AGAIN FOR OPTIONS/ PRESS START</small> 
4. sensor cook	<small>PRESS AGAIN FOR OPTIONS/ PRESS START</small> 
5.  START plus 30 sec	

Sensor Cook chart

FOOD	AMOUNT	PROCEDURE
1. Bacon	1-3 slices	Place bacon strips on a microwave bacon rack for best results. (Use dinner plate lined with paper towels if rack is not available).
2. Frozen Dinner	10 oz./ 20 oz.	Place in a appropriately sized microwave container. Cover with plastic wrap . After cooking, stir and allow to stand for 3 minutes.
3. Rice	1-2 cups Use medium or long grain rice. Cook instant rice according to directions on the package.	Place rice and twice as much liquid (water, chicken or vegetable stock) in a 2 quart microwave dish. Cover with plastic wrap and vent. After cooking, allow to stand for 10 minutes. Stir for fluffier rice.
4. Frozen Breakfast	8/12 oz.	Place in a appropriately sized microwave container. Cover with plastic wrap . After cooking, stir and allow to stand for 3 minutes.
5. Frozen Pizza	12 oz.	Remove from package. Place on an appropriately sized microwavable plate. For prepackaged microwavable pizza follow the instructions on the package.

Sensor Reheat

- Suppose you want to reheat casserole with sensor reheat.

Procedure	
Step	Touch
1. sensor reheat	<small>PRESS AGAIN FOR OPTIONS/ PRESS START</small> BEVERAGE <small>SENSOR</small>
2. sensor reheat	<small>PRESS AGAIN FOR OPTIONS/ PRESS START</small> PIZZA <small>SENSOR</small>
3. sensor reheat	<small>PRESS AGAIN FOR OPTIONS/ PRESS START</small> SOUP SAUCE <small>SENSOR</small>
4. sensor reheat	<small>PRESS AGAIN FOR OPTIONS/ PRESS START</small> CASSEROLE <small>SENSOR</small>
5.  START plus 30 sec	CASSEROLE <small>SENSOR COOK</small>

Sensor Reheat chart

FOOD	AMOUNT	PROCEDURE
1. Beverage	1-3 Cups	Do not cover.
2. Pizza	12 Oz	Place pizza slices on a paper towel-lined microwave-safe plate in the center of the turntable.
3. Soup/Sauce	1-2 Cups	Place in shallow microwavable casserole. Cover with vented plastic wrap. After cooking, stir and let stand 3 minutes.
4. Casserole/ Lasagna	1-4 Servings	Place in a microwavable bowl or casserole. Cover with vented plastic wrap. After cooking, stir and let stand 3 minutes

18 ONE TOUCH COOK

Popcorn

The Popcorn quick touch pad lets you pop 3.3, 3.0, 1.75 ounce bags of commercially packaged microwave popcorn. Pop only one package at a time. If you are using a microwave popcorn popper, follow manufacturer's instructions.

- Suppose you want to pop a 3.3 oz. popcorn.

Procedure	
Step	Touch
1. popcorn	<small>PRESS AGAIN FOR OPTIONS/ PRESS START</small> 3.3 <small>oz</small>
2.  START plus 30 sec	POPCORN <small>COOK</small> Time counting down
Amount	Press popcorn pad
3.30 oz.	once
3.00 oz.	2 times
1.75 oz.	3 times

NOTE

1. Remove the metal shelf from microwave oven when cooking popcorn. Do not use regular paper bags. Do not re-pop unpopped kernels. Do not pop popcorn in glass cookware.

Veggies

The Veggies quick touch pad lets you cook potatoes, fresh and frozen vegetables.

- Suppose you want to cook frozen veggies.

Procedure	
Step	Touch
1. veggies	<small>PRESS AGAIN FOR OPTIONS/ PRESS START</small> POTATO <small>SENSOR</small>
2. veggies	<small>PRESS AGAIN FOR OPTIONS/ PRESS START</small> FRESH VEGGIES
3. veggies	<small>PRESS AGAIN FOR OPTIONS/ PRESS START</small> FROZEN VEGGIES
4.  START plus 30 sec	FROZEN VEGGIES <small>COOK</small> Time counting down



Key	Food	Amount
Veggies x1	Potato	1-4
Veggies x2	Fresh Veggies	1-4 cups
Veggies x3	Frozen Veggies	1-4 cups

Touch Veggie key repeatedly to switch between Potato, Fresh and Frozen selections.

Snacks

Snack Menu is for cooking/heating foods that take a short amount of time!

- Suppose you want to reheat 2 cups of beverage.

Procedure	
Step	Touch
1. snacks	<small>PRESS AGAIN FOR OPTIONS/ PRESS START</small> BEVERAGE
2.  START plus 30 sec	1-3 CUP
3.  2	<small>PRESS START</small> 2 CUPS
4.  START plus 30 sec	BEVERAGE <small>COOK</small> Time counting down



Snacks Chart

FOOD	AMOUNT	PROCEDURE
1. Beverage	1 - 3 cups	To reheat beverages. Stir liquid briskly before and after heating to avoid "eruption" .
2. Frozen MW Pizza	(6 - 8 oz) (170 - 225 g)	Use for frozen microwave pizza. Remove from package and unwrap. Follow package directions for use of package and/or silver crisping disk.
3. Hot Dogs	1 - 6 pieces	Place hot dog in bun. Wrap each with paper towel or napkin.
4. Meal in a Cup	2.39 oz	This setting is ideal for individual portions of canned food packed in a small microwaveable container, usually 6 to 8 ounces. Remove inner metal lid and replace outer microwaveable lid. After cooking, stir food and allow to stand 1 or 2 minutes.
5. Frozen Kid's Meal	8.8 oz	Use this pad for frozen, convenience foods. It will give satisfactory results for most brands. You may wish to try several and choose your favorite. Remove package from outer wrapping and follow package directions for covering. After cooking, let stand, covered for 1 to 3 minutes.
6. Soup	1-4 cups	Place in shallow microwavable casserole. Cover with vented plastic wrap. After cooking, stir and let stand 3 minutes.

Melt/Soften

The oven uses low power to melt and soften items. See the following table.

- Suppose you want to melt 2 sticks of Butter.

Procedure	
Step	Touch
1. melt/soften	<small>PRESS AGAIN FOR OPTIONS/ PRESS START</small> MELT BUTTER
2.  <small>START plus 30 sec</small>	ENTER 1-2 STK
3. 	<small>PRESS START</small> 2 STICK
4.  <small>START plus 30 sec</small>	MELT BUTTER <small>COOK</small> Time counting down





Melt/Soften Chart

CATEGORY	AMOUNT	DIRECTION
BUTTER	1 or 2 sticks	Unwrap and place in microwavable container. No need to cover butter. Stir at the end of cooking to complete melting.
CHOCOLATE	2, 4 or 8 oz.	Chocolate chips or squares of baking chocolate may be used. Unwrap squares and place in microwavable container. Stir at the end of cycle to complete melting.
ICE CREAM	Pint, 1.5 Quart.	Place container in oven. Ice cream will be soft enough to make scooping easier.
CREAM CHEESE	3 or 8 oz.	Unwrap and place in microwavable container. Cream cheese will be at room temperature and ready for use in recipe.

Keep Warm

The default keep warm temperature is 170 degrees.

- Suppose you want to keep warm for 20 minutes.

Procedure	
Step	Touch
1. keep warm	<small>PRESS START</small> ENTER TIME
2.    	<small>PRESS START</small> 20:00
3.  <small>START plus 30 sec</small>	20:00 <small>CONVECT</small> Time counting down

NOTE

If you do not set a keep warm time, just press Convection Keep Warm then touch START, you can keep warm up to 90 minutes.

Auto Defrost



The auto defrost feature provides you with the best defrosting method for frozen foods. The cooking guide will show you which defrost sequence is recommended for the food you are defrosting.

For added convenience, the Auto Defrost includes a built-in beep mechanism that reminds you to check, turn over, separate, or rearrange the food in order to get the best defrost results. Three different defrosting levels are provided:

1. **MEAT**
2. **POULTRY**
3. **FISH**
4. **BREAD**

Available weight is 0.1-6.0 lbs

- Suppose you want to defrost 1.2 lbs of fish.

Procedure	
Step	Touch
1. auto defrost	<small>PRESS AGAIN FOR OPTIONS/ PRESS START</small> MEAT
2. auto defrost	<small>PRESS AGAIN FOR OPTIONS/ PRESS START</small> POULTRY
3. auto defrost	<small>PRESS AGAIN FOR OPTIONS/ PRESS START</small> FISH
4.  START plus 30 sec	ENTER WEIGHT <small>RD</small>
5. ① and ② To enter weight	<small>PRESS START</small> 1.2 <small>RD</small>
6.  START plus 30 sec	<small>DEFR.</small> FISH Time counting down

NOTE

The oven will beep during the DEFROST cycle. At this time, open the door and turn, separate, or rearrange the food. Remove any portions that have thawed. Return frozen portions to the oven and touch START to resume the defrost cycle.

Operating Tips

- For best results, remove fish, shell fish, meat and poultry from its original closed paper or plastic package (wrapper). Otherwise, the wrap will hold steam and juice close to the foods, which can cause the outer surface of the foods to cook.
- For best results, roll your ground meat into a ball before freezing. During the DEFROST cycle, the microwave will signal when it is time to turn the meat over. Scrape off any excess frost from the meat and continue defrosting.
- Place foods in a shallow container or on a microwave roasting rack to catch drippings.

This table shows food type selections and the weights you can set for each type. For best results, loosen or remove covering on food.

KEY PRESS	Category	WEIGHTS YOU CAN SET (tenths of a pound)
Defrost	Meat	0.1 to 6.0
Defrost	Poultry	0.1 to 6.0
Defrost	Fish	0.1 to 6.0
Defrost	Bread	0.1 to 6.0

Weight conversion table

You are probably used to measuring food in pounds and ounces that are fractions of a pound (for example, 4 ounces equals 1/4 pound). However, in order to enter food weight in Auto Defrost, you must specify pounds and tenths of a pound.

If the weight on the food package is in fractions of a pound, you can use the following table to convert the weight to decimals.

Equivalent Weight	
OUNCES	DECIMAL WEIGHT
1.6	.10
3.2	.20
4.0	.25 One-Quarter Pound
4.8	.30
6.4	.40
8.0	.50 One-Half Pound
9.6	.60
11.2	.70
12.0	.75 Three-Quarters Pound
12.8	.80
14.4	.90
16.0	1.0 One Pound

NOTE

If between two decimal weights, choose the lower weight for the best defrosting results.

Auto Defrost Table

NOTE: Meat of irregular shape and large, fatty cuts of meat should have the narrow or fatty areas shielded with foil at the beginning of the defrost sequence.

Meat Settings

FOOD	SETTING	AT BEEP	SPECIAL INSTRUCTIONS
BEEF			
Ground Beef, Bulk	MEAT	Remove thawed portions with fork. Turn over. Return remainder to oven.	Do not defrost less than 1/4 lb. Freeze in ball shape.
Ground Beef, Patties	MEAT	Separate and rearrange.	Do not defrost less than 2 oz. patties. Depress center when freezing.
Round Steak	MEAT	Turn over. Cover warm areas with aluminum foil.	Place in a microwave safe dish.
Tenderloin Steak	MEAT	Turn over. Cover warm areas with aluminum foil.	Place in a microwave safe dish.
Stew Beef	MEAT	Remove thawed portions with fork. Separate remainder.	Place in a microwave safe dish.
Pot Roast, Chuck Roast	MEAT	Return remainder to oven.	Place in a microwave safe dish.
Rib Roast	MEAT	Turn over. Cover warm areas with aluminum foil.	Place in a microwave safe dish.
Rolled Rump Roast	MEAT	Turn over. Cover warm areas with aluminum foil.	Place in a microwave safe dish.
LAMB			
Cubes for Stew	MEAT	Turn over. Cover warm areas with aluminum foil.	Place in a microwave safe dish.
Chops (1 inch thick)	MEAT	Remove thawed portions with fork. Return remainder to oven.	Place in a microwave safe dish.
PORK			
Chops (1/2 inch thick)	MEAT	Separate and rearrange.	Place in a microwave safe dish.
Hot Dogs	MEAT	Separate and rearrange.	Place in a microwave safe dish.
Spareribs Country-style Ribs	MEAT	Turn over. Cover warm areas with aluminum foil.	Place in a microwave safe dish.
Sausage, Links	MEAT	Separate and rearrange.	Place in a microwave safe dish.
Sausage, Bulk	MEAT	Remove thawed portions with fork. Turn over. Return remainder to oven.	Place in a microwave safe dish.
Loin Roast, Boneless	MEAT	Turn over. Cover warm areas with aluminum foil.	Place in a microwave safe dish.

Auto Defrost Table (Continued)

Poultry Settings

FOOD	SETTING	AT BEEP	SPECIAL INSTRUCTIONS
CHICKEN Whole (up to 6 lbs) Cut-up	POULTRY	Turn over breast side down. Cover warm areas with aluminum foil. Separate pieces and rearrange. Turn over. Cover warm areas with aluminum foil.	Place chicken breast-side up in a microwave safe dish. Finish defrosting by immersing in cold water. Remove giblets when chicken is partially defrosted. Place in a microwave safe dish. Finish defrosting by immersing in cold water.
CORNISH HENS Whole	POULTRY	Turn over. Cover warm areas with aluminum foil.	Place in a microwave safe dish. Finish defrosting by immersing in cold water.
TURKEY Breast (up to 6 lbs)	POULTRY	Turn over. Cover warm areas with aluminum foil.	Place in a microwave safe dish. Finish defrosting by immersing in cold water.

Fish Settings

FOOD	SETTING	AT BEEP	SPECIAL INSTRUCTIONS
FISH Fillets	FISH	Turn over. Separate fillets when partially thawed, if possible.	Place in a microwave safe dish. Carefully separate fillets under cold water.
Steaks	FISH	Separate and rearrange.	Place in a microwave safe dish. Run cold water over to finish defrosting.
Whole	FISH	Turn over	Place in a microwave safe dish. Cover head and tail with foil; do not let foil touch sides of microwave. Finish defrosting by immersing in cold water.
SHELLFISH Crab meat	FISH	Break apart. Turn over.	Place in a microwave safe dish.
Lobster tails	FISH	Turn over and rearrange.	Place in a microwave safe dish.
Shrimp	FISH	Separate and rearrange.	Place in a microwave safe dish.
Scallops	FISH	Separate and rearrange.	Place in a microwave safe dish.

Defrosting Tips

- When using Auto Defrost, the weight to be entered is the net weight in pounds and tenths of pounds (the weight of the food minus the container).
- Before Starting, make sure to remove any and all metal twist-ties that often come with frozen food bags, and replace them with strings or elastic bands.
- Open containers, such as cartons, before placing in the oven.
- Always slit or pierce plastic pouches or packaging.
- If food is foil wrapped, remove foil and place food in a suitable container.
- Slit the skin of skinned food, such as sausage.
- Bend plastic pouches of food to ensure even defrosting.
- Always underestimate defrosting time. If defrosted food is still icy in the center, return it to the microwave oven for more defrosting.
- The length of defrosting time varies according to how solidly the food is frozen.
- The shape of the package affects how quickly food will defrost. Shallow packages will defrost more quickly than a deep block.
- As food begins to defrost, separate the pieces. Separated pieces defrost more easily.
- Use small pieces of aluminum foil to shield parts of food such as chicken wings, leg tips, fish tails, or areas that start to get warm. Make sure the foil does not touch the sides, top, or bottom of the oven. The foil can damage the oven lining.
- For better results, let food stand after defrosting.
- Turn over food during defrosting or standing time. Break apart and remove food as required.

Tips for Convection Cooking

This section gives you cooking instructions and procedures for operating each convection function. Please read these instructions carefully.

Convection cooking circulates hot air through the oven cavity with a fan. The constantly moving air surrounds the food to heat the outer portion quickly, creating even browning and sealed-in flavor by the constant motion of hot air over the food surfaces. Your oven uses convection cooking whenever you use the Convection Button. **DO NOT USE THE OVEN WITHOUT THE TURNTABLE IN PLACE.**



1. Always use the metal rack on the turntable when convection cooking.
2. Do not cover turntable or metal rack with aluminum foil. It interferes with the flow of air that cooks the food.
3. Round pizza pans are excellent cooking utensils for many convection-only items. Choose pans that do not have extended handles.
4. Use convection cooking for items like souffles, breads, cookies, angel food cakes, pizza, and for some meat and fish.
5. You do not need to use any special techniques to adapt your favorite oven recipes to convection cooking; however, you need to lower oven temperature by 25°F from recommended temperature mentioned in package instructions when cooking packaged food in convection mode.
6. When baking cakes, cookies, breads, rolls, or other baked foods, most recipes call for preheating. Preheat the empty oven just as you do a regular oven. You can start heavier dense foods such as meats, casseroles, and poultry without preheating.
7. All heat-proof cookware or metal utensils can be used in convection cooking.
8. Use metal utensils only for convection cooking. Never use for microwave or combination cooking since arcing and damage to the oven may occur.
9. After preheating if you do not open the door, the oven will automatically hold at the preheated temperature for 30 minutes.

PRECAUTIONS

- The oven cavity, door, turntable, roller rest, metal tray, metal rack, and cooking utensils will become very hot. USE THICK OVEN GLOVES when removing the food, cooking utensils, metal rack, metal tray, and turntable from the oven after convection cooking.
- Do not use lightweight plastic containers, plastic wraps, or paper products during any convection.

Convection Preheat

- Suppose you want to preheat to 400 degrees.

Procedure	
Step	Touch
1. convection preheat	PREHEAT ENTER TEMP
2. 	PRESS START 400 F
3.  START plus 30 sec	PREHEAT CONVECT



The display will show PREHEAT up to 200 deg F. then display temperature in 25 degree increments (e.g. 225, 250). up to the set temperature.

NOTE

- When the oven reaches the set preheat temperature, three(3) tones will sound and the display will scroll the message "PREHEAT END". The oven will automatically hold that temperature for 30 minutes.
- During convection cooking, the exhaust fan in the vent hood will automatically turn on at the low speed setting to protect the oven.

Convection

- Suppose you want to set the convection cooking at 350 °F. for 20 minutes without preheating.

Procedure	
Step	Touch
1. convection	BAKE/ROAST ENTER TEMP
2. (6)	<small>PRESS START</small> 350 F
3. 	ENTER TIME
4. <small>START plus 30 sec</small>	<small>PRESS START</small> 20:00
5. (2) (0) (0) (0)	
5.  <small>START plus 30 sec</small>	20:00 <small>CONVECT COOK</small> Time counting down

NOTE

The temperature range has 10 steps from 100 °F to 450 °F.

Number Pad	Temperature
1	100° F
2	200° F
3	250° F
4	300° F
5	325° F
6	350° F
7	375° F
8	400° F
9	425° F
0	450° F

Convection Baking Guidelines

1. Dark or non-shiny finishes, glass, and pyroceram absorb heat which may result in dry, crisp crusts.
2. Preheating the oven is recommended when baking foods by convection.
3. To prevent uneven heating and save energy, open the oven door to check food as little as possible.

Food	Oven Temp.	Time, Min.	Comments	
Breads	Refrigerated Biscuits	375°F	11 to 14	Allow additional time for large biscuits.
	Corn Bread	350°F	35 to 40	
	Muffins	425°F	18 to 22	Remove from pans immediately and cool slightly on wire rack. Pierce each popover with a fork after removing from oven to allow steam to escape.
	Popovers	325°F	45 to 55	
	Nut Bread or Fruit Bread	325°F	60 to 70	
	Yeast Bread	375°F	16 to 23	
	Plain or Sweet Rolls	350°F	13 to 16	
Cakes	Devil's Food	350°F	35 to 40	Place cake pan on rack. If using a 9X13 cake pan turn off the turntable.
	Fudge brownies	350°F	26 to 30	
	Coffee Cake	325°F	30 to 35	
	Cup Cakes	325°F	20 to 25	
	Fruit Cake (loaf)	275°F	90 to 100	
	Gingerbread	300°F	25 to 30	
	Butter Cakes, Cake	325°F	35 to 45	
	Tube Cake	325°F	35 to 45	
	Pound Cake	325°F	30 to 40	Cool in pan 10 minutes before inverting on wire rack.
Cookies	Chocolate Chip	350°F	11 to 14	Place metal tray on rack. Allow extra time for frozen cookie dough. Place metal tray on rack.
	Sugar	350°F	11 to 14	
Fruits, Other Desserts	Baked Apples or Pears	350°F	35 to 40	Bake in cookware with shallow sides. Pudding is done when knife inserted near center comes out clean.
	Bread Pudding	300°F	35 to 40	
	Cream Puffs	400°F	30 to 35	Puncture puffs twice with toothpick to release steam after 25 minutes of baking time. When done, turn oven off and let shells stand in oven 1 hour to dry.
	Meringue Shells	300°F	30 to 35	

NOTES

- The temperatures in the table above are a guideline for your reference. Follow package or recipe instructions.
- The baking time in the table above is only a guideline for your reference. You need to adjust time according to the food condition or your preference. Check readiness at the minimum time.

Convection Baking Guidelines (cont'd)

Food		Oven Temp.	Time, Min.	Comments
Pies, Pastries	Frozen Pie	400°F	50 to 60	Place metal tray on rack and place in cold oven. Preheat oven, tray and rack to 400°F. When preheated, place frozen pie on metal tray and bake according to package time or until crust is browned and filling is hot.
	Meringue-Topped	450°F	9 to 11	Follow package directions for preparation.
	Two-Crust	400°F	50 to 55	Follow package directions for preparation.
	Quiche	350°F	30 to 35	Let stand 5 minutes before cutting.
	Pastry Shell	400°F	10 to 16	Pierce pastry with fork to prevent shrinkage.
Casseroles	Meat, Chicken, Seafood Combinations	350°F	20 to 40	Cook times vary with casserole size and ingredients.
	Pasta	350°F	25 to 45	Cook times vary with casserole size and ingredients.
	Potatoes, scalloped	350°F	55 to 60	Let stand 5 minutes before serving.
	Vegetable	350°F	25 to 35	Cook times vary with casserole size and ingredients.
Convenience Foods	Frozen Bread Dough	350°F	30 to 35	Follow package directions for preparation.
	Frozen Entree	325°F	70 to 80	Follow package directions for preparation.
	Pizza Rising Crust	400°F	25 to 35	Follow package directions for preparation. Pizza should not extend over the rack.
	Frozen Pizza	400°F	17 to 21	Follow package directions for preparation. Pizza should not extend over the rack.
	French Fries Crinkle	450°F	15 to 19	Follow package directions for preparation.
	Cut Frozen Waffle	400°F	5 to 7	Follow package directions for preparation.
	Frozen Cheese Sticks	450°F	6 to 8	Follow package directions for preparation.
	Frozen Turnovers	450°F	18 to 22	Follow package directions for preparation.
Main Dishes	Meat Loaf	400°F	30 to 40	Let stand 5 minutes after cooking.
	Oven-Baked Stew	325°F	80 to 90	Brown meat before combining with liquid and vegetables.
	Swiss Steak Stuffed Peppers	350°F 350°F	60 to 70 40 to 45	Let stand 2 minutes after cooking. Use green, red, or yellow peppers.
Vegetables	Acorn Squash Halves	375°F	55 to 60	Add ½ cup water to dish. Turn squash halves cut side up after 30 minutes of cook time and cover.
	Baked Potatoes Twice-Baked Potatoes	425°F 400°F	50 to 60 25 to 30	Pierce skin with fork before baking.

NOTES

- The temperatures in the table above are a guideline for your reference. Follow package or recipe instructions.
- The baking time in the table above is only a guideline for your reference. You need to adjust time according to the food condition or your preference. Check readiness at the minimum time.

Meat roasting guidelines for convection cooking

Food	Oven Temp.	Time, Min. / lb.
Beef	Rib roast, bone-in	325°F 23 to 25
	Rib roast, boneless	325°F 28 to 33
	Tenderloin	300°F 15 to 20
	Pot Roast	300°F 30 to 35
	Chuck, Rump Roast	300°F 30 to 35
Ham	Meat Loaf (2 lbs.)	400°F 65 to 75
	Canned (3-lb. fully cooked)	325°F 18 to 20
	Butt (5-lb. fully cooked)	325°F 18 to 20
	Shank (5-lb. fully cooked)	325°F 18 to 20
Lamb	Bone-in	300°F 20 to 25
	Boneless	300°F 25 to 30
Pork	Bone-in	300°F 20 to 30
	Boneless	300°F 20 to 30
Poultry	Whole Chicken (2½ to 3½ lbs.)	375°F 25 to 35
	Chicken Pieces (2½ to 3½ lbs.)	425°F 10 to 12
	Duckling (4 to 5 lbs.)	375°F 30 to 35
	Turkey Breast (4 to 6 lbs.)	325°F 21 to 25
Seafood	Fish, whole (3 to 5 lbs.)	400°F 13 to 18
	Lobster Tails (6 to 8-oz. each)	350°F 8 to 9

NOTES

- The roasting time in the table above is only a guideline for your reference. You need to adjust the time according to the food condition or your preference. Check readiness at the minimum time.
- Use a meat thermometer to check the internal temperature of the food.

Tips for Fast Cook

This section gives you instructions to operate Fast Cook function. Please read these instructions carefully. Sometimes combination microwave-convection cooking is suggested to get the best cooking results since it shortens the cooking time for foods that normally need a long time to cook. This cooking process also leaves meats juicy on the inside and crispy on the outside. In combination cooking, the convection heat and microwave energy alternate automatically.

Helpful Hints for Fast Cook



- Meats** may be roasted directly on the metal rack or in a shallow roasting pan placed on the rack. When using the metal rack, please check your cooking guide for information on proper use.
- Less tender** cuts of beef can be roasted and tenderized using oven cooking bags.
- When baking**, check for doneness after cooking time is up. If not completely done, let stand in oven for a few minutes to complete cooking.

Precautions

- All cookware used for combination cooking must be BOTH microwave-safe and oven-safe.
- During Fast Cook baking, some baking cookware may cause arcing when it comes in contact with the oven walls or metal accessory racks. Arcing is a discharge of electricity that occurs when microwaves come in contact with metal.
 - If arcing occurs, immediately stop the cooking cycle and place a microwavable safe dish between the pan and the metal rack.
 - We recommend you use the metal rack supplied with your oven. It has rubber feet that helps prevent arcing.
 - If arcing occurs with other baking cookware, do not use them for combination cooking.

Fast Cook

- Suppose you want to bake 15 minutes at 325 degrees default.

Procedure	
Step	Touch
1. fast cook	<small>PRESS AGAIN FOR OPTIONS/ PRESS START</small> BAKE 325 F
2. 	ENTER TIME
3. 	<small>PRESS START</small> 15:00
4. 	<small>MICRO + CONVECT COOK</small> 15:00 Time counting down

Bake (Degrees F)	Key	Microwave Setting
325	Default	10%
250	3	10%
300	4	10%
325	5	10%
350	6	10%
375	7	10%
400	8	10%

Roast (Degrees F)	Key	Microwave Setting
300	Default	30%
325	5	30%
350	6	30%
375	7	30%
400	8	30%
425	9	30%
450	0	30%

Combination Roast Cooking Guide

Food	Oven Temp.	Time, Min. / lb.
Beef	Turn over after half of cooking time.	
Rib roast, bone-in	325°F	10 to 14
Rib roast, boneless	325°F	10 to 14
Beef Tenderloin	375°F	10 to 14
Chuck, Rump or Pot Roast	300°F	12 to 22
Ham	Turn over after half of cooking time.	
Canned (3-lb. fully cooked)	300°F	7 to 9
Butt (5-lb. fully cooked)	300°F	7 to 9
Shank (5-lb. fully cooked)	300°F	7 to 9
Lamb	Turn over after half of cooking time.	
Bone-in (2 to 4 lbs.)		
Medium	300°F	13 to 18
Well	300°F	18 to 23
Boneless (2 to 4 lbs.)		
Medium	300°F	14 to 19
Well	300°F	19 to 24
Poultry	Turn over after half of cooking time.	
Whole Chicken (2½ to 6 lbs.)	375°F	15 to 17
Chicken Pieces (2½ to 6 lbs.)	375°F	15 to 18
Cornish Hens (untied)		
Unstuffed	425°F	15 to 18
Stuffed	375°F	22 to 25
Duckling	375°F	15 to 18
Turkey Breast (4 to 6 lbs.)	300°F	11 to 15
Seafood		
Fish		
1-lb. fillets	350°F	7 to 10
Lobster Tails (6 to 8-oz. each)	350°F	10 to 15
Shrimp (1 to 2 lbs.)	350°F	9 to 14
Scallops (1 to 2 lbs.)	350°F	8 to 13

NOTES

- The roasting time in the table above is only a guideline for your reference. You need to adjust the time according to the food condition or your preference. Check doneness at the minimum time.
- Use a meat thermometer to check the internal temperature of the food.

Combination Bake Cooking Guide

Food	Oven Temp.	Time, Min.	Comments
Pies, Pastries			
Quiche	425°F	15 to 17	Let stand 5 minutes before cutting.
Frozen Entree			
Convenience Foods			
Pizza Rolls, Egg Rolls	375°F	39 to 43	Follow package directions for preparation.
Pizza	450°F	4 to 6	Follow package directions for preparation.
Vegetables			
Baked Potatoes	450°F	23 to 26	Pierce skin with a fork before baking. Place on rack.

NOTES

- The time in the table above is only a guideline for your reference. You need to adjust time according to the food condition or your preference. Check doneness at the minimum time on the package.

1. Setting Clock

The clock can be disabled when the microwave is first plugged in and the STOP key is selected. To re-enable the clock follow clock instructions.

- Suppose you want to set the clock for 10:59.

Procedure	
Step	Touch
1. set clock	12:00 ENTER TIME
2. ① ① ⑤ ⑨	10:59 <small>PRESS START</small>
3. 	10:59

NOTE

1. If you begin to enter in an incorrect time (e.g. 2:89) the 8 is an invalid digit and cannot be entered. Enter the correct time.
2. If you touch STOP while setting the clock, the display will show the last time of day set or a blank display if no time of day has been set.



2. User Pref

The microwave oven has settings that allow you to customize the operation for your convenience. Below is the table showing the various settings. Touch the User Pref key multiple times to scroll to the desired setting function.

Key press	Option
User Pref x1	Control Lock
User Pref x2	Volume On/Low/Med/High
User Pref x3	Weight lb/kg
User Pref x4	Demo

(1). Setting Control Lock On/Off

- Suppose you want to turn ON Control Lock

Procedure	
Step	Touch
1. user pref	<small>PRESS AGAIN FOR OPTIONS/ PRESS START</small> CONTROL LOCK
2. 	Time of day if time of day was set LOCK
To turn OFF the Control Lock, touch User Pref then touch  .	

(2).Turning Volume Off/Low/Med/High

Audible signals are available to guide you when setting and using your oven.

- A **programming tone** will sound each time you touch a pad.
- **Three tones** signal the end of a Kitchen Timer countdown.
- **Three tones** signal the end of a cooking cycle.
- Suppose you want to turn audible signal off.

Procedure	
Step	Touch
1. user pref	<small>PRESS AGAIN FOR OPTIONS/ PRESS START</small> CONTROL LOCK
	<small>PRESS AGAIN FOR OPTIONS/ PRESS START</small> VOLUME ON
2. user pref	<small>PRESS AGAIN FOR OPTIONS/ PRESS START</small> VOLUME LOW
	<small>PRESS AGAIN FOR OPTIONS/ PRESS START</small> VOLUME MED
	<small>PRESS AGAIN FOR OPTIONS/ PRESS START</small> VOLUME HIGH
3.  START plus 30 sec	OFF

NOTE

When START is pressed and the previous setting was ON then it will be set to OFF. If you want to turn the audible signal back ON you will have to again press four times and then START.

When the cooking cycle is completed END will be displayed and the audible signal will sound if the sound is turned on.

(3).Setting Weight Ib/Kg

- Suppose you want to toggle weight between pounds & kilograms.

Procedure	
Step	Touch
1. user pref	<small>PRESS AGAIN FOR OPTIONS/ PRESS START</small> CONTROL LOCK
	<small>PRESS AGAIN FOR OPTIONS/ PRESS START</small> VOLUME ON
2. user pref	<small>PRESS AGAIN FOR OPTIONS/ PRESS START</small> VOLUME LOW
	<small>PRESS AGAIN FOR OPTIONS/ PRESS START</small> VOLUME MED
	<small>PRESS AGAIN FOR OPTIONS/ PRESS START</small> VOLUME HIGH
3. user pref	<small>PRESS AGAIN FOR OPTIONS/ PRESS START</small> KG / LB
4.  START plus 30 sec	KG <small>kg</small>

NOTE

If the display shows kg, pressing the START button will reset the oven controls to lbs. To return to kg, you will have to again press five times and then START.

(4).Setting Demo Mode On/Of

- Suppose you want to enter Demo mode.

Procedure	
Step	Touch
1. user pref	<small>PRESS AGAIN FOR OPTIONS/ PRESS START</small> CONTROL LOCK
2. user pref	<small>PRESS AGAIN FOR OPTIONS/ PRESS START</small> VOLUME ON <small>PRESS AGAIN FOR OPTIONS/ PRESS START</small> VOLUME LOW <small>PRESS AGAIN FOR OPTIONS/ PRESS START</small> VOLUME MED <small>PRESS AGAIN FOR OPTIONS/ PRESS START</small> VOLUME HIGH
3. user pref	<small>PRESS AGAIN FOR OPTIONS/ PRESS START</small> KG / LB
4. user pref	<small>PRESS AGAIN FOR OPTIONS/ PRESS START</small> DEMO OFF
5.  START plus 30 sec	ON

NOTE

When START is pressed and the previous setting was OFF then it will be set to ON. If you want to turn the demo mode back OFF you will have to again press four times and then START.

3. Setting Kitchen Timer

Your microwave oven can be used as a kitchen timer. You can set up to 99 minutes, 99 seconds. The kitchen timer can be used while the microwave oven is running.

- Suppose you want to set for three minutes.

Procedure	
Step	Touch
1. timer	
2.	
3.	

NOTE

Timer count down does not stop even if the door is open. To cancel the timer, press the " STOP" key once.

4. Using Vent Fan

The pad controls the 2-speed vent fan. If the vent fan is OFF the first touch of the Vent pad will turn the fan on LOW, second touch HIGH and third touch OFF.

- Suppose you want to set the vent fan speed to LOW from the OFF position.

Procedure	
Step	Touch
1. fan lo/hi	
2. fan lo/hi	

Turn off fan when desired

NOTE

If the temperature from the range or cooktop below the oven gets too hot, the vent fan will automatically turn on to protect the oven. It may stay on up to an hour to cool the oven. When this occurs, the Vent pad will not turn the fan off.

5. Using Cooktop Light

The pad controls the cooktop light. If the light is OFF the first touch of the light pad will turn the light ON (high), second touch Nite (low) and third touch OFF.

- Suppose you want to set the light for HIGH from the OFF position.

Procedure	
Step	Touch
1. cook light	

6. Setting Turntable On/Off

Press **Turntable On-Off** to turn the turntable on or off.

For best cooking results, leave the turntable on. It can be turned off for large dishes.

Procedure	
Step	Touch
1. turntable on/off	
2. turntable on/off	

NOTE

Sometimes the turntable can become hot to the touch during and after cooking. Do not run the oven empty without food in it.

Caring for Your Microwave Oven

In order to ensure that your microwave oven looks good and works well for a long time, you should maintain it properly. For proper care, please follow these instructions carefully.

For interior surfaces: Wash often with warm, sudsy water and a sponge or soft cloth. Use only mild, nonabrasive soaps or a mild detergent. Be sure to keep the areas clean where the door and oven frame touch when closed. Wipe well with clean cloth.

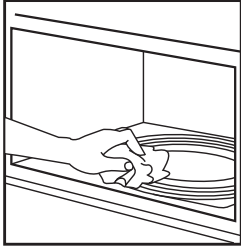

Over time, surfaces may stain as a result of food particles splattering during cooking. This is normal.

For stubborn soil: Boil a cup of water in the oven for two to three minutes. Steam will soften the soil. To get rid of odors inside the oven, boil a cup of water with some lemon juice or vinegar in it. **NOTE:** Use the Clean option in Clock & Settings for a preset timed cycle for stubborn soil cleaning.

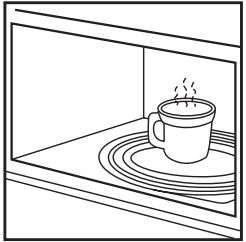

For exterior surfaces and control panel: Use a soft cloth with spray glass cleaner. Apply the spray glass cleaner to the soft cloth; do not spray directly on the oven.

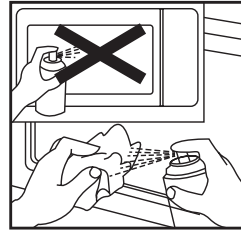

NOTE: Abrasive cleansers, steel wool pads, gritty wash cloths, some paper towels, etc., can damage the control panel and the interior and exterior oven surfaces.

To clean glass turntable and turntable support: Wash in mild, sudsy water. For heavily soiled areas, use a mild cleanser and scouring sponge. The glass turntable and turntable support are dishwasher safe.

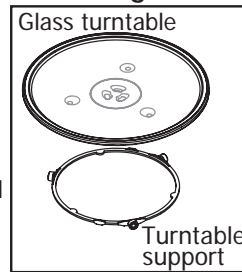

Caring for the Filters

The grease filters should be removed and cleaned often; at least once a month.

NOTE: Models are shipped for recirculating exhaust (To duct air outside reference the Installation Instructions book included with your microwave.). Some models have a disposable charcoal filter installed to help remove smoke and odors. The charcoal filter cannot be cleaned and should be replaced every 6 to 12 months.

Grease filters

1. Unplug microwave oven or disconnect power.

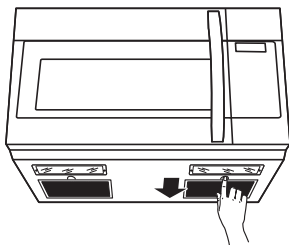

2. To remove grease filters, slide each filter to the side. Pull filters downward and push to the other side the filter will drop out.

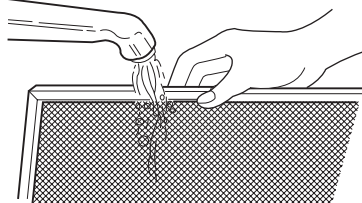

3. Soak grease filters in hot water and a mild detergent. Scrub and swish to remove embedded dirt and grease. Rinse well and shake to dry. Do not clean filters with ammonia, corrosive cleaning agents, such as lye-based oven cleaners, or place them in a dishwasher. The filters will turn black or become damaged.

4. To replace grease filters, slide filter in the frame slot on one side of the opening. Push filter upward and push to the other side to lock into place.

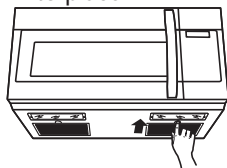

5. Plug in microwave oven or reconnect power.

NOTE: Do not operate the hood without the grease filters in place.

Charcoal filters

1. Unplug microwave oven or disconnect power.

2. Open the microwave door and remove the two vent mounting screws located on top of the microwave using a #1 Phillips screwdriver.

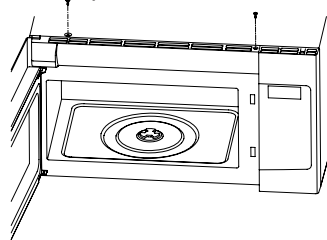

3. Slide the vent left and tip forward. Lift out to remove.

4. Lift the bottom of the charcoal filter. Slide the filter straight out.

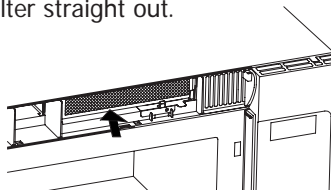

5. Slide a new charcoal filter into place. The filter should rest like the picture shown below.

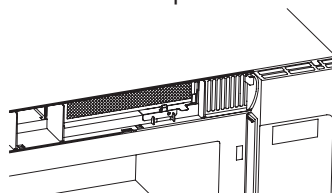

6. Reinstall the vent by sliding the bottom of the vent into place. Push the vent top into position and slide right into place. Replace the two vent mounting screws located on top of the microwave using a #1 Phillips screwdriver.

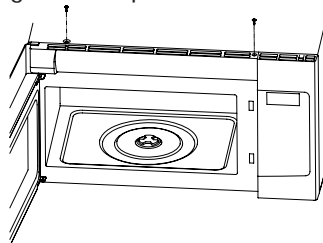

7. Close the microwave door. Plug in microwave oven or reconnect power.

Replacing The Cooktop And oven Cavity lights

The cooktop lights

1. Unplug microwave oven or disconnect power.



2. Remove the bulb cover mounting screw for the specific bulb you want to replace.
3. Replace bulb with candelabra-base 30-watt bulb.
4. Plug in microwave oven or reconnect power.

The oven cavity light

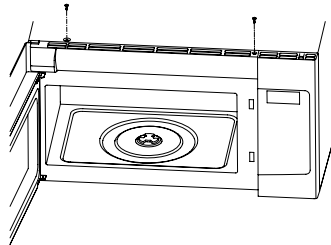

1. Unplug microwave oven or disconnect power.
2. Open the microwave door and remove the two vent mounting screws located on top of the microwave using a # 1 Phillips screwdriver.
3. Slide the vent left and tip forward, then lift out to remove.

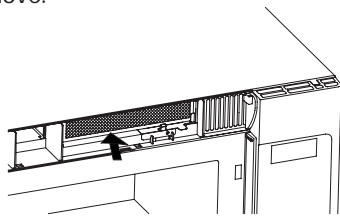

4. Lift the bottom of the charcoal filter. Slide the filter straight out.

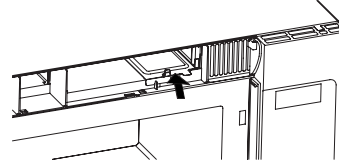

5. Lift up the bulb holder.
6. Replace the bulb with a candelabra-base 30-watt bulb .
7. Replace the bulb holder.
8. Slide the charcoal filter into place. The filter should rest like the picture shown below.

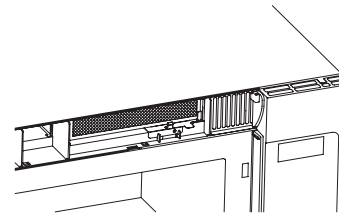

9. Reinstall the vent by sliding the bottom of the vent into place. Push the vent top into position and slide right into place. Replace the two vent mounting screws located on top of the microwave using a # 1 Phillips screwdriver.

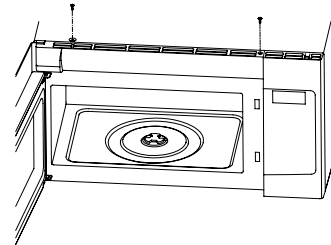

10. Close the microwave door. Plug in microwave oven or reconnect power.

Please check the following before calling for service:

Place one cup of water in a glass measuring cup in the oven and close the door securely.

Operate the oven for one minute at HIGH 100%.

- | | | | |
|----------|--|-----------|----------|
| A | Does the microwave oven light come on? | YES _____ | NO _____ |
| B | Does the cooling fan work? (Put your hand at top above Display.) | YES _____ | NO _____ |
| C | Does the turntable rotate? (It is normal for the turntable to turn in either direction.) | YES _____ | NO _____ |
| D | Is the water in the microwave oven warm? | YES _____ | NO _____ |

If "NO" is the answer to any of the above questions, please check electrical outlet, fuse and/or circuit breaker. If they are functioning properly, CONTACT YOUR NEAREST ELECTROLUX AUTHORIZED SERVICER.

A microwave oven should never be serviced by a "do-it-yourself" repair person.

NOTES

1. If time appearing in the display is counting down very rapidly, check Demonstration Mode on page 34 and cancel.

SPECIFICATIONS

AC Line Voltage:	Single phase 120V, 60Hz, AC only
AC Power Required:	1500 W 13.5 amps. (for EI30SM35QS)
Output Power:*	900 watts
Output Power:*(convection):	1300 watts
Frequency:	2450 MHz (Group 2/Class B)**
Overall Dimensions(WxHxD)	29 7/8" X 16 13/32" X 15 1/32"
Oven Cavity Dimensions(WxHxD)	20 1/4" X 9 1/4" X 14 13/32"
Microwave Oven Capacity***:	1.5 Cu. Ft.
Weight:	Approx. (net) 63.8 lb, (gross) 69.3 lb
Work/Night Light:	2 bulbs 30w each (incandescent light bulbs)
Oven Light:	1 bulb 30w (incandescent light bulbs)

* The International Electrotechnical Commission's standardized method for measuring output wattage. This test method is widely recognized.

** This is the classification of ISM (Industrial, Scientific and Medical) equipment described in the International Standard CISPR11. (for EI30SM35QS)

*** Internal capacity is calculated by measuring maximum width, depth and height. Actual capacity for holding food is less.

In compliance with standards set by:

FCC - Federal Communications Commission Authorized.

DHHS - Complies with Department of Health and Human Services (DHHS) rule, CFR, Title 21, Chapter I, Subchapter J.



- This symbol on the nameplate means the product is listed by Underwriters Laboratories, Inc.

Major Appliance Warranty Information

Your appliance is covered by a one year limited warranty. For one year from your original date of purchase, Electrolux will repair or replace any parts of this appliance that prove to be defective in materials or workmanship when such appliance is installed, used, and maintained in accordance with the provided instructions. In addition, the magnetron tube of your appliance is covered by a two through five year limited warranty. During the 2nd through 5th years from your original date of purchase, Electrolux will provide a replacement magnetron tube for your appliance which has proven to be defective in materials or workmanship when your appliance is installed, used, and maintained in accordance with the provided instructions.

Exclusions

This warranty does not cover the following:

1. Products with original serial numbers that have been removed, altered or cannot be readily determined.
2. Product that has been transferred from its original owner to another party or removed outside the USA or Canada.
3. Rust on the interior or exterior of the unit.
4. Products purchased "as-is" are not covered by this warranty.
5. Food loss due to any refrigerator or freezer failures.
6. Products used in a commercial setting.
7. Service calls which do not involve malfunction or defects in materials or workmanship, or for appliances not in ordinary household use or used other than in accordance with the provided instructions.
8. Service calls to correct the installation of your appliance or to instruct you how to use your appliance.
9. Expenses for making the appliance accessible for servicing, such as removal of trim, cupboards, shelves, etc., which are not a part of the appliance when it is shipped from the factory.
10. Service calls to repair or replace appliance light bulbs, air filters, water filters, other consumables, or knobs, handles, or other cosmetic parts.
11. Labor or in-home service costs during the additional limited warranty periods beyond the first year from your original date of purchase.
12. Pickup and delivery costs; your appliance is designed to be repaired in the home.
13. Surcharges including, but not limited to, any after hour, weekend, or holiday service calls, tolls, ferry trip charges, or mileage expense for service calls to remote areas, including the state of Alaska.
14. Damages to the finish of appliance or home incurred during transportation or installation, including but not limited to floors, cabinets, walls, etc.
15. Damages caused by: services performed by unauthorized service companies; use of parts other than genuine Electrolux parts or parts obtained from persons other than authorized service companies; or external causes such as abuse, misuse, inadequate power supply, accidents, fires, or acts of God.

DISCLAIMER OF IMPLIED WARRANTIES; LIMITATION OF REMEDIES

CUSTOMER'S SOLE AND EXCLUSIVE REMEDY UNDER THIS LIMITED WARRANTY SHALL BE REPAIR OR REPLACEMENT AS PROVIDED HEREIN. **CLAIMS BASED ON IMPLIED WARRANTIES, INCLUDING WARRANTIES OF MERCHANTABILITY OR FITNESS FOR A PARTICULAR PURPOSE, ARE LIMITED TO ONE YEAR OR THE SHORTEST PERIOD ALLOWED BY LAW, BUT NOT LESS THAN ONE YEAR.** ELECTROLUX SHALL NOT BE LIABLE FOR CONSEQUENTIAL OR INCIDENTAL DAMAGES SUCH AS PROPERTY DAMAGE AND INCIDENTAL EXPENSES RESULTING FROM ANY BREACH OF THIS WRITTEN LIMITED WARRANTY OR ANY IMPLIED WARRANTY. SOME STATES AND PROVINCES DO NOT ALLOW THE EXCLUSION OR LIMITATION OF INCIDENTAL OR CONSEQUENTIAL DAMAGES, OR LIMITATIONS ON THE DURATION OF IMPLIED WARRANTIES, SO THESE LIMITATIONS OR EXCLUSIONS MAY NOT APPLY TO YOU. THIS WRITTEN WARRANTY GIVES YOU SPECIFIC LEGAL RIGHTS. YOU MAY ALSO HAVE OTHER RIGHTS THAT VARY FROM STATE TO STATE.

If You Need Service

Keep your receipt, delivery slip, or some other appropriate payment record to establish the warranty period should service be required. If service is performed, it is in your best interest to obtain and keep all receipts. Service under this warranty must be obtained by contacting Electrolux at the addresses or phone numbers below.

This warranty only applies in the USA, Puerto Rico and Canada. In the USA and Puerto Rico, your appliance is warranted by Electrolux Major Appliances North America, a division of Electrolux Home Products, Inc. In Canada, your appliance is warranted by Electrolux Canada Corp. Electrolux authorizes no person to change or add to any obligations under this warranty. Obligations for service and parts under this warranty must be performed by Electrolux or an authorized service company. Product features or specifications as described or illustrated are subject to change without notice.

USA

1-877-435-3287

Electrolux Home Products, Inc.,
10200 David Taylor Drive
Charlotte, NC 28262

Canada

1-800-265-8352

Electrolux Canada Corp.
5855 Terry Fox Way
Mississauga, Ontario, Canada L5V 3E4

