

Double Wall Ovens

EI30EW45J S, EI30EW45K W, EI30EW45K B



Luxury-Glide® Oven Rack

With a ball bearing system, oven rack is so smooth it extends effortlessly.



Perfect Convection3®

Our convection technology features a third convection element for consistently even results, up to 30% faster cooking times and even more baking options.



Luxury-Design® Lighting

Our ramp-up designer halogen lighting is as beautiful as it is functional.



Sure-2-Fit® Capacity

Coordinate an entire meal — our ovens feature 4.2 cu. ft. of cooking space with three adjustable baking racks.

30" ELECTRIC DOUBLE WALL OVENS

Configuration	Double
Control Panel Features	
IQ-Touch™ Electronic Oven Controls	Yes
Keypad Entry of Time & Temperature	Yes
Electronic Clock & Timer	Yes
Temperature Display	Yes
Toggle Control	Yes
Automatic Oven (Delay, Cook & Off)	Yes
Lockout	Yes
Automatic Oven Shutoff – 12 Hour	Yes
Programmable for °F or °C	Yes
Luxury-Design® Halogen Oven Light Touch Pad	Yes
Oven Features	
Oven Cavity (both ovens)	4.2 Cu. Ft.
Hidden Bake Element	Yes
Electric Bake Element – 2200 Watts	Yes
Eight-Pass Broil Element – 4000 Watts	Yes
Convection Element – 2500 Watts	Yes
Cobalt Blue Interior	Yes
Self-Clean Options with Door Lock	3
Perfect Convection3® with Variable 2-Speed Fans	Yes
Cooking Modes – Bake, Broil, Convection Bake, Convection Roast, Convection Broil, Keep Warm, Slow Cook	7
Baking Options – Dehydrate, Bread Proof, My Favorite, Rapid Preheat, Delay Bake, Convection Convert	6
Luxury-Design® Lighting with Dual 40W Halogen Bulbs	Yes
Luxury-Glide® Racks	1
Conventional Racks	2
Convection Roasting Rack	Yes
Additional Features	
Signature Soft-Arc Oven Door and Handle Design	Yes
Luxury-Hold™ Oven Doors	Yes
Extra-Large Glass Windows	Yes
Sabbath Mode (Star-K® Certified)	Yes
Accessories	
Porcelain Broiler Pan and Insert	Included
3"-high Bottom Trim: S – PN# 903114-9110, W – PN# 903114-9101, B – PN# 903114-9100	Optional
Specifications	
Color –	
Stainless Steel	S
White	W
Black	B
Oven Cavity Dimensions –	
Height	16-1/2"
Width	24-1/8"
Depth	18-1/32"
Product Dimensions –	
Height (Including 1" Bottom Trim)	50-7/16"
Width	30"
Depth (to Front Door Corner) (with 90° Door Open)	24-1/2" 44"
Power Supply Connection Location	
Connected Load (kW Rating) @ 240/208 Volts	8.0/6.0
Amps @ 240/208 Volts	33.0/29.0
Minimum Circuit Required (Amps)	40
Armored Electrical Cable	Included
Shipping Weight (Approx.)	395 Lbs.

NOTE: Always consult local and national electric codes. Refer to Product Installation Guide for detailed installation instructions on the web at electroluxappliances.com. Specifications subject to change.

Double Wall Ovens

EI30EW45J S, EI30EW45K W, EI30EW45K B

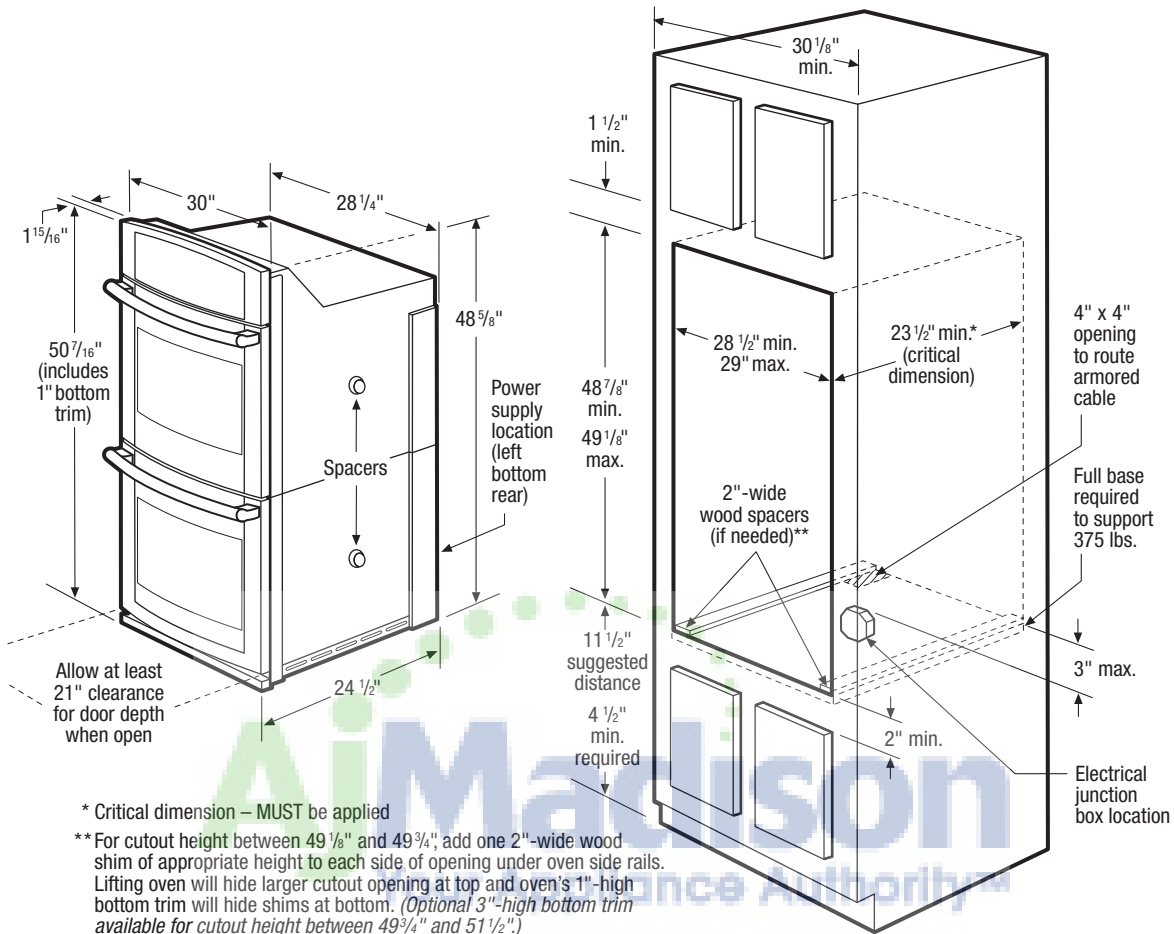

800-570-3355

30" Electric Double Wall Oven Specifications

- Product Weight – 375 Lbs.
- Single phase 3- or 4-wire cable, 120/240 or 120/208 Volt, 60 Hertz AC only electrical supply with ground required on separate circuit fused on both sides of line.
- Connected Load (kW Rating) @ 240/208 Volts = 8.0/6.0kW
- Amps @ 240/208 Volts = 33.0/29.0 Amps
- Recommended Circuit Breaker – 40 Amps
- Always consult local and national electric codes.
- Minimum 21" clearance for oven door depth when open.
- Suggested distance from floor is 11-1/2". Minimum required distance is 4-1/2".
- Minimum 23-1/2" deep cutout dimension is critical for proper installation, to ensure that oven's faceplate will fit flush against cabinet front.
- To adapt oven to fit cutout height between 49-1/8" and 49-3/4", add one 2"-wide wood shim of appropriate height to each side of opening under oven side rails. Lifting oven will hide larger cutout opening at top and oven's 1"-high bottom trim will hide shims at bottom. (Standard 1"-High Bottom Trim included.)

- To adapt oven to fit cutout height between 49-3/4" and 51-1/2", optional 3"-High Bottom Trim available.
- Full oven base of solid plywood or similar material required, capable of supporting 375 Lbs.
- Base must be level and cabinet front must be square.
- Double Wall Ovens are NOT approved to be used in stackable or side-by-side installation.

Note: For planning purposes only. Refer to Product Installation Guide on the web at electroluxappliances.com for detailed instructions.

Optional Accessories

- 3"-High Bottom Trim: S – (PN# 903114-9110), W – (PN# 903114-9101), B – (PN# 903114-9100).

Electrolux Major Appliances, N.A.

USA • 10200 David Taylor Drive • Charlotte, NC 28262 • 1-877-4electrolux (1-877-435-3287) • electroluxappliances.com
 CANADA • 5855 Terry Fox Way • Mississauga, ON L5V 3E4 • 1-800-265-8352 • electroluxappliances.ca

EI30EW45K 06/11

© 2011 Electrolux Home Products, Inc.



High standards of quality at Electrolux Home Products, Inc. mean we are constantly working to improve our products. We reserve the right to change specifications or discontinue models without notice.

Printed in the U.S.A.

Use these dimensions and clearance instructions for planning purposes only. For detailed installation instructions, refer to installation guide, packed with product, or on the web at electroluxappliances.com.

Front

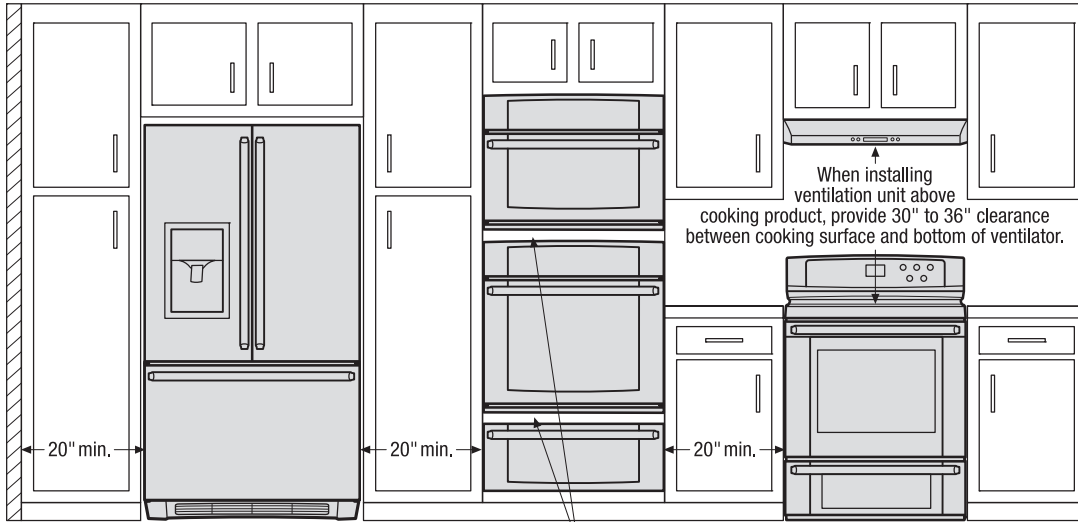

When installing appliances adjacent to each other, 20" minimum distance between each appliance required.

When installing built-in cooking appliances in combination, 2" minimum visible gap between appliance faceplates required.

Top

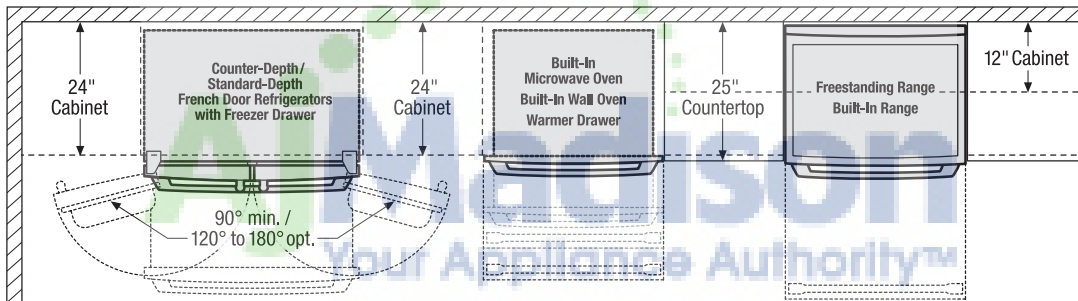

When installing refrigerator adjacent to wall, cabinet or another appliance that extends beyond front edge of unit, 20" minimum clearance recommended to allow for optimum 120° to 180° door swing, providing complete drawer/crisper access and removal.

When installing appliance with sliding drawer or drop-down door directly across from obstructions, provide sufficient clearance for drawer extension or door swing.

Front

To ensure optimum performance, avoid installing refrigeration appliances in direct sunlight or near heat source.

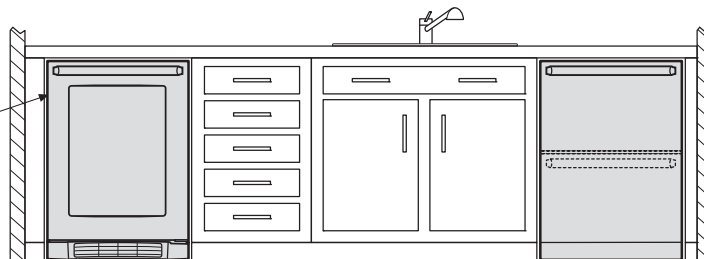

Top

When installing appliance with side-swing door adjacent to wall, cabinet, or other obstruction that extends beyond front edge of appliance, door swing and handle clearance must be sufficient to allow access to appliance interior.

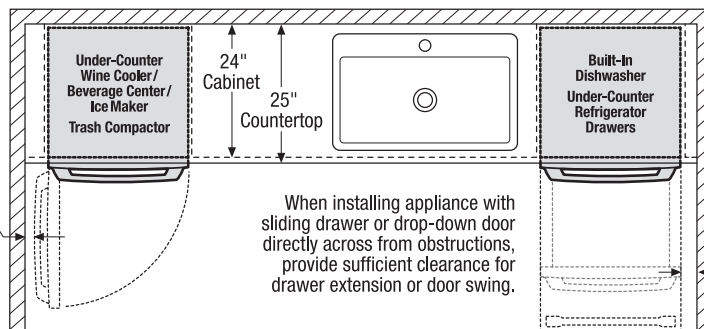

When installing appliance with sliding drawer or drop-down door directly across from obstructions, provide sufficient clearance for drawer extension or door swing.

When installing appliance with sliding drawer or drop-down door adjacent to wall, cabinet, or other obstruction that extends beyond front edge of appliance, allow 2" minimum clearance between drawer or door and obstruction.

Electrolux Major Appliances, N.A.

USA • 10200 David Taylor Drive • Charlotte, NC 28262 • 1-877-4electrolux (1-877-435-3287) • electroluxappliances.com
 CANADA • 5855 Terry Fox Way • Mississauga, ON L5V 3E4 • 1-800-265-8352 • electroluxappliances.ca

Use these dimensions and clearance instructions for planning purposes only. For detailed installation instructions, refer to installation guide, packed with product, or on the web at electroluxappliances.com.

Front

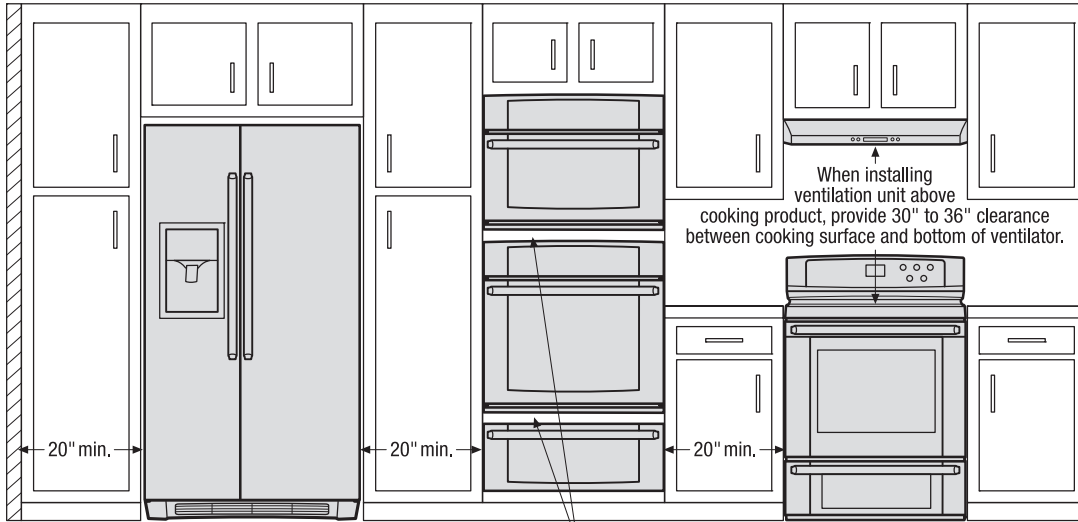

When installing appliances adjacent to each other, 20" minimum distance between each appliance required.

When installing built-in cooking appliances in combination, 2" minimum visible gap between appliance faceplates required.

Top

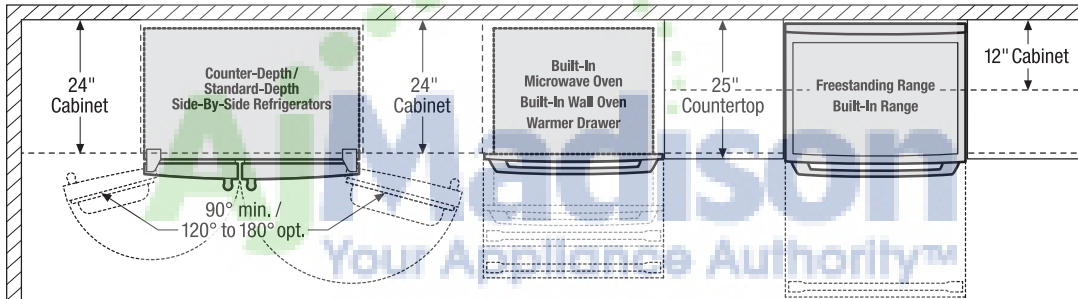

When installing refrigerator adjacent to wall, cabinet or another appliance that extends beyond front edge of unit, 20" minimum clearance recommended to allow for optimum 120° to 180° door swing, providing complete drawer/crisper access and removal.

When installing appliance with sliding drawer or drop-down door directly across from obstructions, provide sufficient clearance for drawer extension or door swing.

Front

To ensure optimum performance, avoid installing refrigeration appliances in direct sunlight or near heat source.

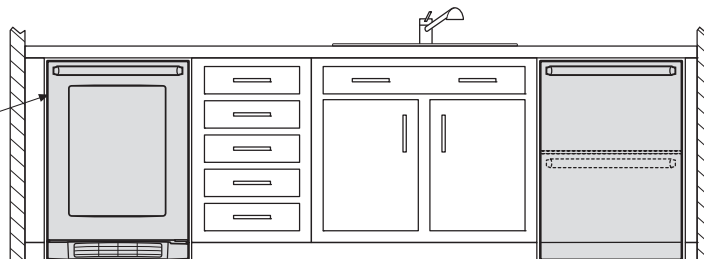

Top

When installing appliance with side-swing door adjacent to wall, cabinet, or other obstruction that extends beyond front edge of appliance, door swing and handle clearance must be sufficient to allow access to appliance interior.

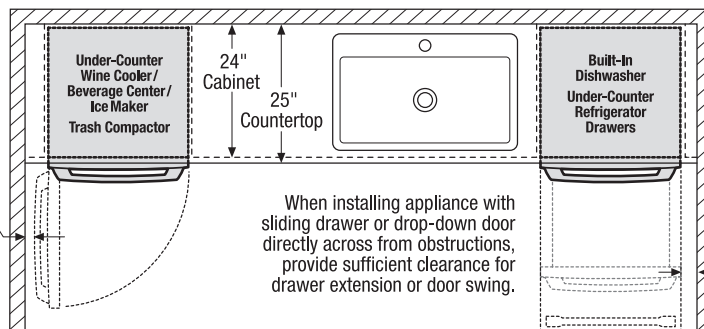

When installing appliance with sliding drawer or drop-down door directly across from obstructions, provide sufficient clearance for drawer extension or door swing.

When installing appliance with sliding drawer or drop-down door adjacent to wall, cabinet, or other obstruction that extends beyond front edge of appliance, allow 2" minimum clearance between drawer or door and obstruction.

Electrolux Major Appliances, N.A.

USA • 10200 David Taylor Drive • Charlotte, NC 28262 • 1-877-4electrolux (1-877-435-3287) • electroluxappliances.com
 CANADA • 5855 Terry Fox Way • Mississauga, ON L5V 3E4 • 1-800-265-8352 • electroluxappliances.ca