

Electric Built-In Ranges

EI30ES55J S, EI30ES55L W, EI30ES55L B



Luxury-Glide® Oven Rack

With a ball bearing system, oven rack is so smooth it extends effortlessly.



Flex-2-Fit® Elements

Elements adjust up to three sizes, so the element fits the cookware, not the other way around.



Perfect Convection®

Our convection technology features a third convection element for consistently even results, up to 30% faster cooking times and even more baking options.



Luxury-Design® Lighting

Our ramp-up designer halogen lighting is as beautiful as it is functional.

30" ELECTRIC BUILT-IN RANGES

Control Panel Features

| | |
|------------------------------------|-----|
| IQ-Touch™ Electronic Oven Control | Yes |
| Glide-2-Set® Element Controls | Yes |
| Keypad Entry of Time & Temperature | Yes |
| Electronic Clock & Timer | Yes |
| Temperature Display | Yes |
| Automatic Oven (Delay, Cook & Off) | Yes |

Cooktop Features

| | |
|---|-----|
| Flex-2-Fit® Ceramic Glass Smoothtop | Yes |
| 9" to 12" Dual Expandable Element – 1800W/3000W | 1 |
| 6" to 9" Dual Expandable Element – 1600W/3000W | 1 |
| 5" to 7" Dual Expandable Element – 750W/1800W | 1 |
| 6" Electric Element – 1200W | 2 |
| Hot-Surface Indicator Light | Yes |
| Surface Controls | Yes |

Oven Features

| | |
|--|-------------|
| Capacity | 4.2 Cu. Ft. |
| Hidden Bake Element | Yes |
| Eight-Pass Bake Element – 2500 Watts | Yes |
| Eight-Pass Broil Element – 4000 Watts | Yes |
| Convection Element – 2500 Watts | Yes |
| Cobalt Blue Interior | Yes |
| Self-Clean Options with Door Lock | 3 |
| Perfect Convection® with Variable 2-Speed Fan | Yes |
| Cooking Modes – Bake, Broil, Convection Bake, Convection Roast, Convection Broil, Keep Warm, Slow Cook | 7 |
| Baking Options – Dehydrate, Bread Proof, My Favorites, Rapid Preheat, Delay Bake, Convection Convert | 6 |
| Luxury-Design® Lighting with Dual 40W Halogen Bulbs | Yes |
| Luxury-Glide® Racks | 1 |
| Conventional Racks | 2 |
| Convection Roasting Rack | Yes |

Additional Features

| | |
|----------------------------------|-----|
| Luxury-Hold® Oven Door | Yes |
| Extra-Large Glass Window | Yes |
| Warmer Drawer | Yes |
| Adjustable Leveling Legs | Yes |
| Sabbath Mode (Star-K® Certified) | Yes |
| A.D.A. Compliant* | Yes |

Accessories

| | |
|---|----------|
| Porcelain Broiler Pan and Insert | Included |
| Cleaning Sponge | Included |
| Grill/Griddle – PN# 318251611 | Optional |
| 2" Rear Filler Kit, Side Panel Kit, Backguard Kit, Side Trim Kit – See Back for Part Numbers | Optional |

Specifications

| | |
|--|---------------------|
| Color – | |
| Stainless Steel | S |
| White | W |
| Black | B |
| Oven Cavity Dimensions – | |
| Height | 16-1/2" |
| Width | 24-1/8" |
| Depth | 18-1/32" |
| Product Dimensions – | |
| Height (Adjustable) | 35-3/4" – 36-5/8" |
| Width | 30" |
| Depth (to Center of Arc) (with 90° Door Open) | 28-5/16" 45-1/2" |
| Power Supply Connection Location | Left Bottom Rear |
| Connected Load (kW Rating) @ 240/208 Volts | 15.3/11.7 |
| Amps @ 240/208 Volts | 63.8/56.3 |
| Minimum Circuit Required (Amps) | 50 |
| Shipping Weight (Approx.) | 258 Lbs. |

*When properly installed, meets the appliance standards in the Americans with Disabilities Act and the Architectural Barriers Act Accessibility Guidelines as published by the United States Access Board on June 23, 2004, as amended August 5, 2005.

NOTE: Always consult local and national electric codes. Refer to Product Installation Guide for detailed installation instructions on the web at electroluxappliances.com. Specifications subject to change.

Electric Built-In Ranges

EI30ES55J S, EI30ES55L W, EI30ES55L B

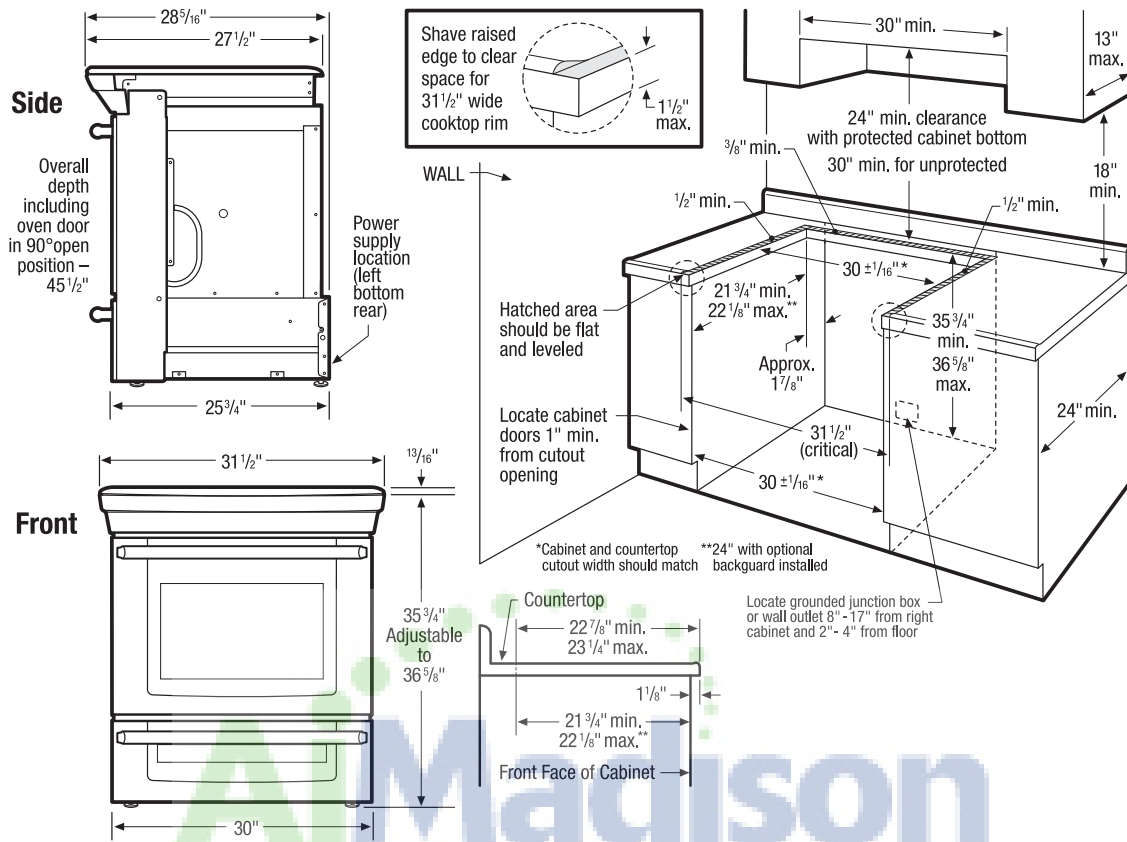

30" Electric Built-In Range Specifications

- Product Weight – 238 Lbs.
- Single phase 3- or 4-wire cable, 120/240 or 120/208 Volt, 60 Hertz, fused on both sides of line with ground. (If local code permits, range may be connected by hard-wiring or by means of power supply cord kit.)
- Connected Load (kW Rating) @ 240/208 Volts = 15.3/11.7 kW
- Amps @ 240/208 Volts = 63.8/56.3 Amps
- Recommended Circuit Breaker – 50 Amps
- Always consult local and national electric codes.
- Make sure all wall coverings around range can withstand heat generated by range.
- Linoleum or any other synthetic floor covering located beneath range, must be capable of withstanding minimum heat of 90° F above room temperature without shrinking, warping or discoloring. Insulating pad or 1/4" -thick plywood required between range and a carpeted floor.
- Countertop MUST be level in all directions and adjustable range height at least 1/16" greater than tallest cabinet height, to ensure metal rangetop flange will fit properly on countertop edge.
- When installing optional Backguard Kit, cutout depth of 21-3/4" minimum / 22-1/8" maximum needs increased to 24".
- Overhead cabinetry should not exceed a 13" maximum depth.
- Absolute minimum horizontal distance between overhead cabinets installed to either side of appliance must be no less than maximum width of appliance.
- Allow 24" minimum clearance between rangetop and bottom of cabinet when bottom of wood or metal cabinet is protected by not less than 1/4" flame-retardant millboard covered with not less than No. 28 MSG sheet steel, 0.015" stainless steel, 0.024" aluminum or 0.020" copper. Allow 30" minimum clearance when cabinet is unprotected.
- To reduce risk of fire when using overhead cabinetry, install range hood that projects horizontally a recommended minimum of 5" beyond bottom of cabinets.

- When installing range into existing cutout depth greater than 22-1/8", optional 2" Rear Filler Kit available.

Countertop Preparation

- For detailed preparation instructions, refer to installation guide on the web.
- Flat square-finish (flat) countertop requires no preparation since rangetop flange lays directly on countertop edge.
 - Formed front-edged countertops require front molded edge to be shaved flat 3/4" from each front corner of opening.
 - Tile countertops may need cut back 3/4" from each front corner of opening and/or rounded edge flattened.
 - For existing cutout width greater than 30-1/16" reduce the 3/4" overlap dimension or for cutout width of 29", replace actual side trim panels with smaller side trim panels, available with optional Side Trim Kit (refer to detailed kit installation instructions).

Note: For planning purposes only. Refer to Product Installation Guide on the web at electroluxappliances.com for detailed instructions.

Optional Accessories

- Grill/Griddle – (PN# 318251611).
- 2" Rear Filler Kit: S – (PN# 903113-901S), W – (PN# 903113-9011), B – (PN# 903113-9010).
- Side Panel Kit: S – (PN# 903102-901S), W – (PN# 903102-9011), B – (PN# 903102-9010).
- Backguard Kit: S – (PN# 903111-901S), W – (PN# 903111-9011), B – (PN# 903111-9010).
- Side Trim Kit: S – (PN# 903110-901S), W – (PN# 903110-9011), B – (PN# 903110-9010).

Electrolux Major Appliances, N.A.

USA • 10200 David Taylor Drive • Charlotte, NC 28262 • 1-877-4electrolux (1-877-435-3287) • electroluxappliances.com
 CANADA • 5855 Terry Fox Way • Mississauga, ON L5V 3E4 • 1-800-265-8352 • electroluxappliances.ca

EI30ES55L 01/12

© 2012 Electrolux Home Products, Inc.



High standards of quality at Electrolux Home Products, Inc. mean we are constantly working to improve our products. We reserve the right to change specifications or discontinue models without notice.

General Installation Guidelines

For Installation with All Refrigerator or All Freezer



Use these dimensions and clearance instructions for planning purposes only. For detailed installation instructions, refer to installation guide, packed with product, or on the web at electroluxappliances.com.

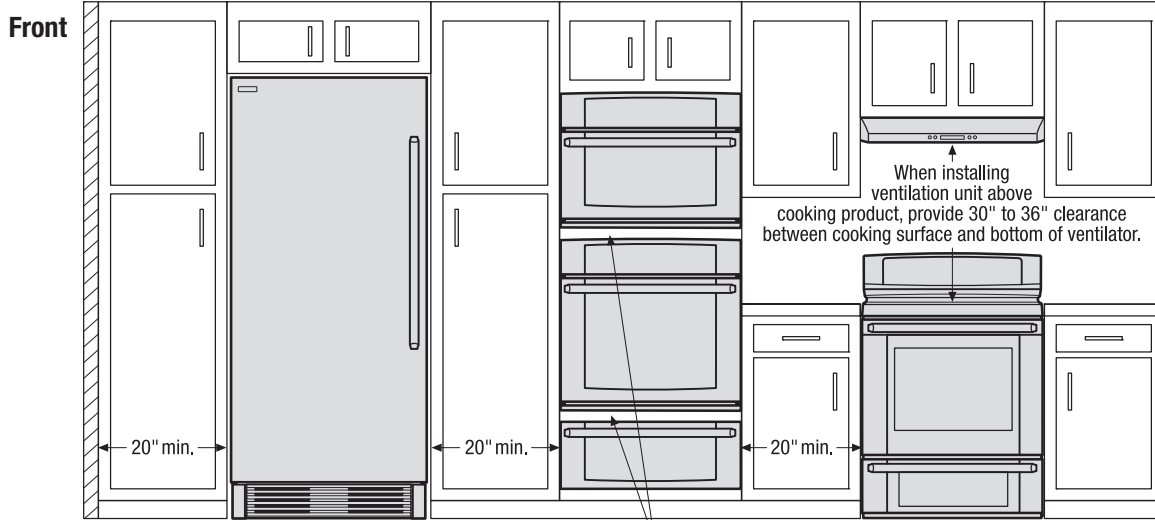

When installing appliances adjacent to each other, 20" minimum distance between each appliance required.

When installing built-in cooking appliances in combination, 2" minimum visible gap between appliance faceplates required.

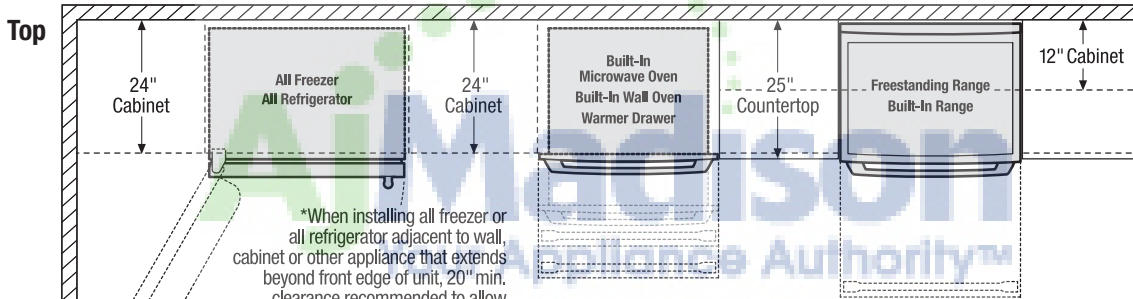

*When installing all freezer or all refrigerator adjacent to wall, cabinet or other appliance that extends beyond front edge of unit, 20" min. clearance recommended to allow for optimum 140° door swing, providing complete drawer/crisper access and removal. (Absolute 4" minimum clearance will ONLY allow for 90° door swing which will provide limited drawer/crisper access with restricted removal.)

When installing appliance with sliding drawer or drop-down door directly across from obstructions, provide sufficient clearance for drawer extension or door swing.

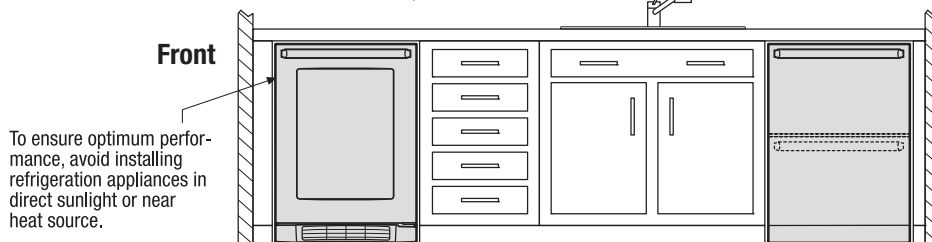

To ensure optimum performance, avoid installing refrigeration appliances in direct sunlight or near heat source.

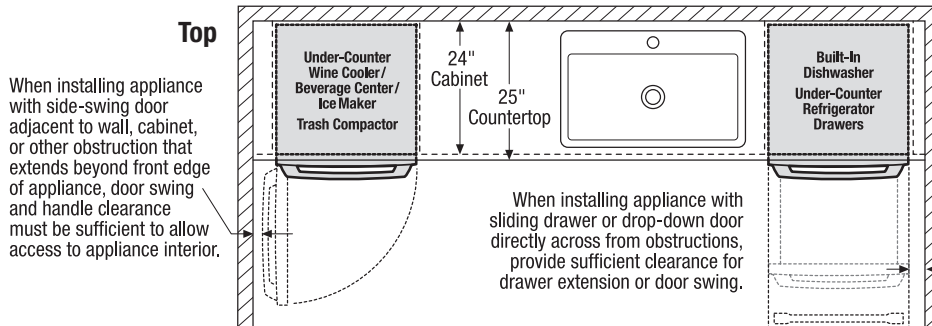

When installing appliance with side-swing door adjacent to wall, cabinet, or other obstruction that extends beyond front edge of appliance, door swing and handle clearance must be sufficient to allow access to appliance interior.

When installing appliance with sliding drawer or drop-down door directly across from obstructions, provide sufficient clearance for drawer extension or door swing.

When installing appliance with sliding drawer or drop-down door adjacent to wall, cabinet, or other obstruction that extends beyond front edge of appliance, allow 2" minimum clearance between drawer or door and obstruction.

Electrolux Major Appliances, N.A.

USA • 10200 David Taylor Drive • Charlotte, NC 28262 • 1-877-4electrolux (1-877-435-3287) • electroluxappliances.com
 CANADA • 5855 Terry Fox Way • Mississauga, ON L5V 3E4 • 1-800-265-8352 • electroluxappliances.ca

General Installation Guidelines

For Installation with French Door Refrigerator



Use these dimensions and clearance instructions for planning purposes only. For detailed installation instructions, refer to installation guide, packed with product, or on the web at electroluxappliances.com.

Front

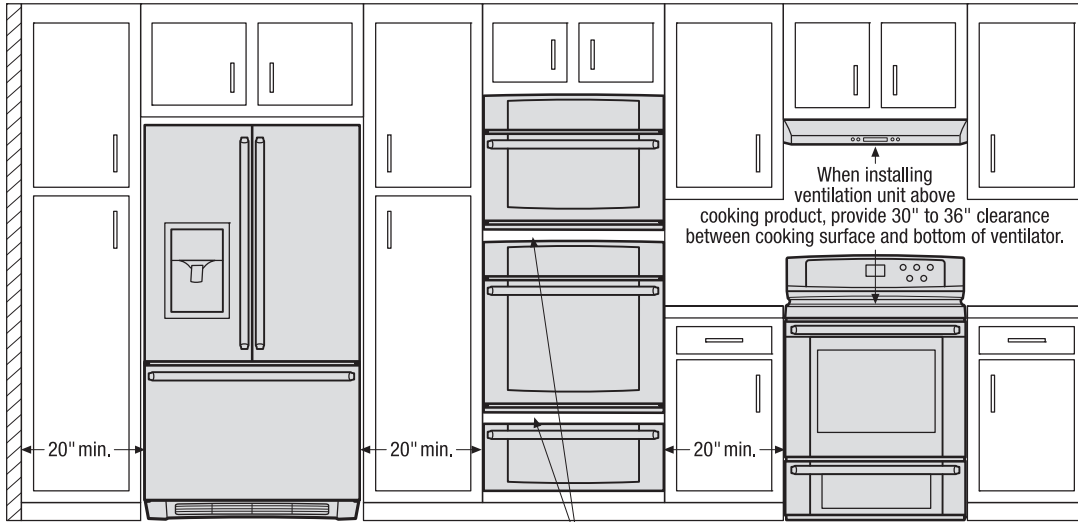

When installing appliances adjacent to each other, 20" minimum distance between each appliance required.

When installing built-in cooking appliances in combination, 2" minimum visible gap between appliance faceplates required.

Top

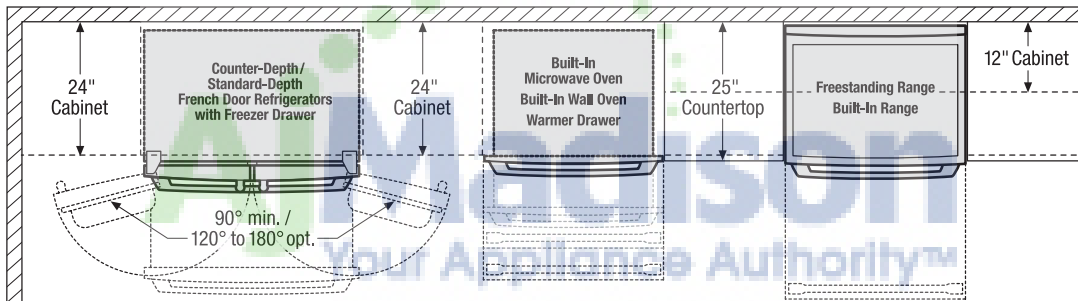

When installing refrigerator adjacent to wall, cabinet or another appliance that extends beyond front edge of unit, 20" minimum clearance recommended to allow for optimum 120° to 180° door swing, providing complete drawer/crisper access and removal.

When installing appliance with sliding drawer or drop-down door directly across from obstructions, provide sufficient clearance for drawer extension or door swing.

Front

To ensure optimum performance, avoid installing refrigeration appliances in direct sunlight or near heat source.

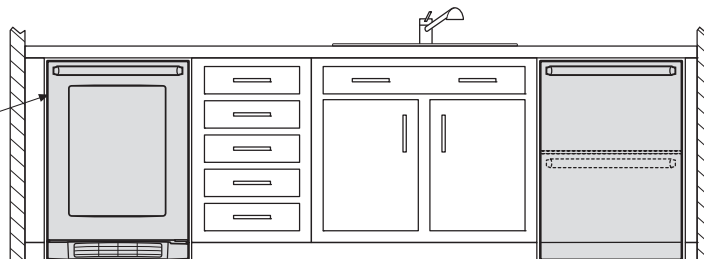

Top

When installing appliance with side-swing door adjacent to wall, cabinet, or other obstruction that extends beyond front edge of appliance, door swing and handle clearance must be sufficient to allow access to appliance interior.

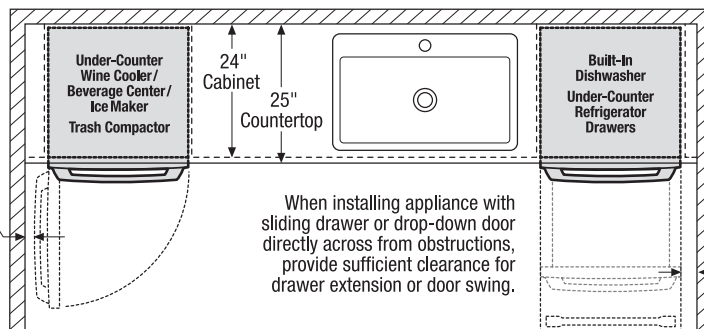

When installing appliance with sliding drawer or drop-down door adjacent to wall, cabinet, or other obstruction that extends beyond front edge of appliance, allow 2" minimum clearance between drawer or door and obstruction.

Electrolux Major Appliances, N.A.

USA • 10200 David Taylor Drive • Charlotte, NC 28262 • 1-877-4electrolux (1-877-435-3287) • electroluxappliances.com
 CANADA • 5855 Terry Fox Way • Mississauga, ON L5V 3E4 • 1-800-265-8352 • electroluxappliances.ca

General Installation Guidelines

For Installation with Side-by-Side Refrigerator



Use these dimensions and clearance instructions for planning purposes only. For detailed installation instructions, refer to installation guide, packed with product, or on the web at electroluxappliances.com.

Front

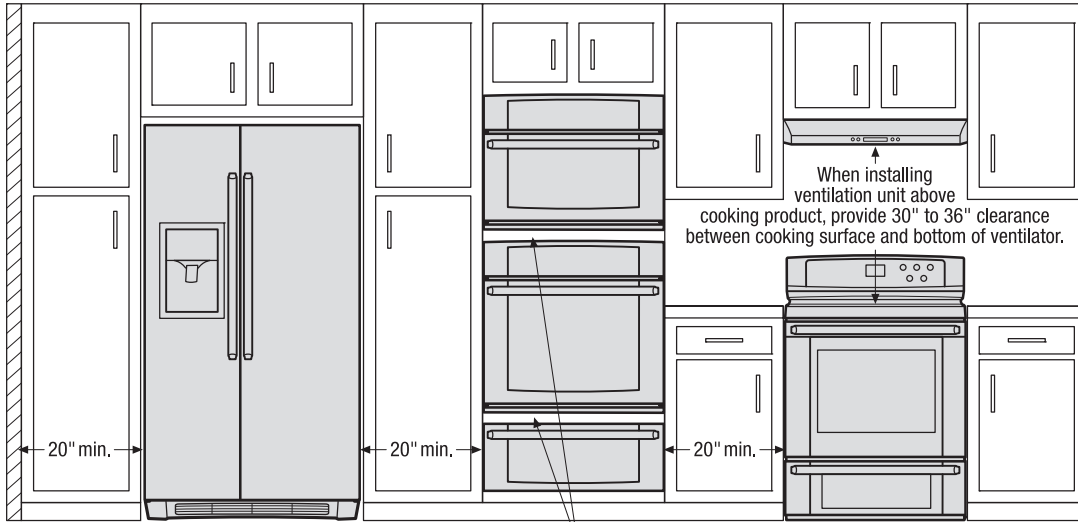

When installing appliances adjacent to each other, 20" minimum distance between each appliance required.

When installing built-in cooking appliances in combination, 2" minimum visible gap between appliance faceplates required.

Top

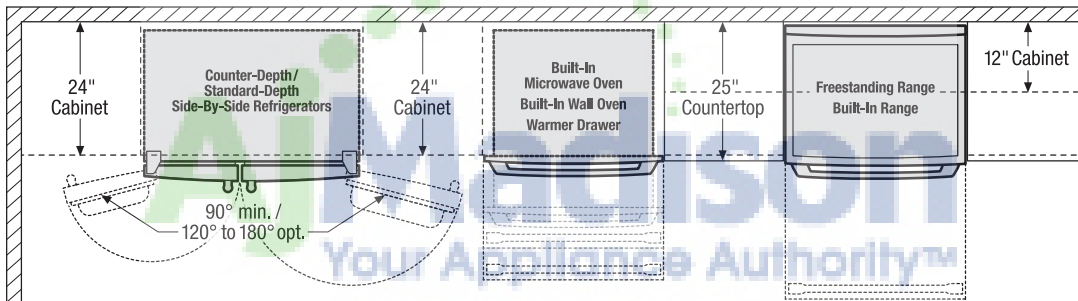

When installing refrigerator adjacent to wall, cabinet or another appliance that extends beyond front edge of unit, 20" minimum clearance recommended to allow for optimum 120° to 180° door swing, providing complete drawer/crisper access and removal.

When installing appliance with sliding drawer or drop-down door directly across from obstructions, provide sufficient clearance for drawer extension or door swing.

Front

To ensure optimum performance, avoid installing refrigeration appliances in direct sunlight or near heat source.

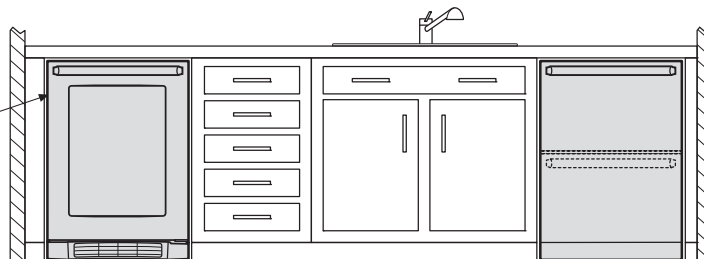

Top

When installing appliance with side-swing door adjacent to wall, cabinet, or other obstruction that extends beyond front edge of appliance, door swing and handle clearance must be sufficient to allow access to appliance interior.

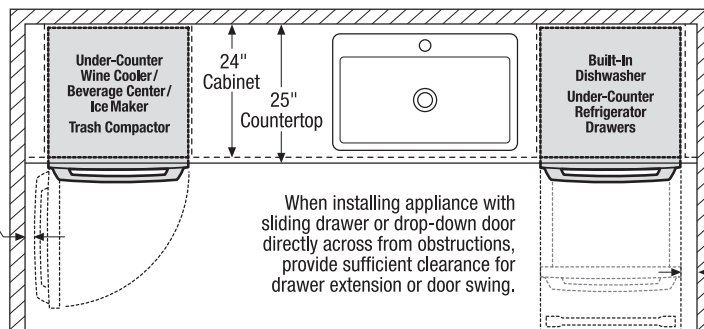

When installing appliance with sliding drawer or drop-down door directly across from obstructions, provide sufficient clearance for drawer extension or door swing.

When installing appliance with sliding drawer or drop-down door adjacent to wall, cabinet, or other obstruction that extends beyond front edge of appliance, allow 2" minimum clearance between drawer or door and obstruction.

Electrolux Major Appliances, N.A.

USA • 10200 David Taylor Drive • Charlotte, NC 28262 • 1-877-4electrolux (1-877-435-3287) • electroluxappliances.com
 CANADA • 5855 Terry Fox Way • Mississauga, ON L5V 3E4 • 1-800-265-8352 • electroluxappliances.ca