



**OPERATING MANUAL
MODE D'EMPLOI
MANUAL DE FUNCIONAMIENTO**

COOLING MODEL

**ROOM AIR CONDITIONER
WALL MOUNTED TYPE**

**Indoor Unit
MW09C1E
MW12C1E**

**Outdoor Unit
MR09C1E
MR12C1E**

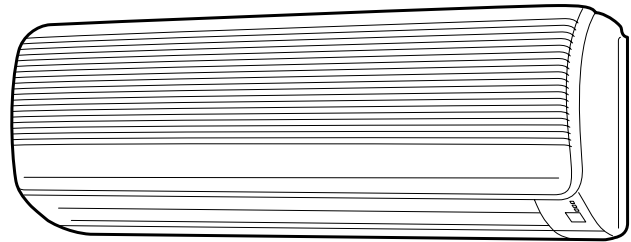

English

Français

Español

**KEEP THIS OPERATION MANUAL
FOR FUTURE REFERENCE**

- Refer to the fold-out page on the cover.

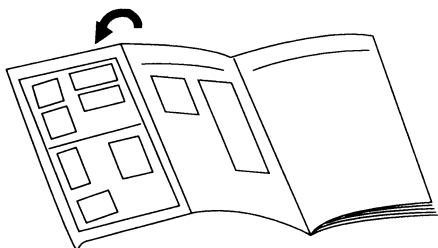

Fig. 1

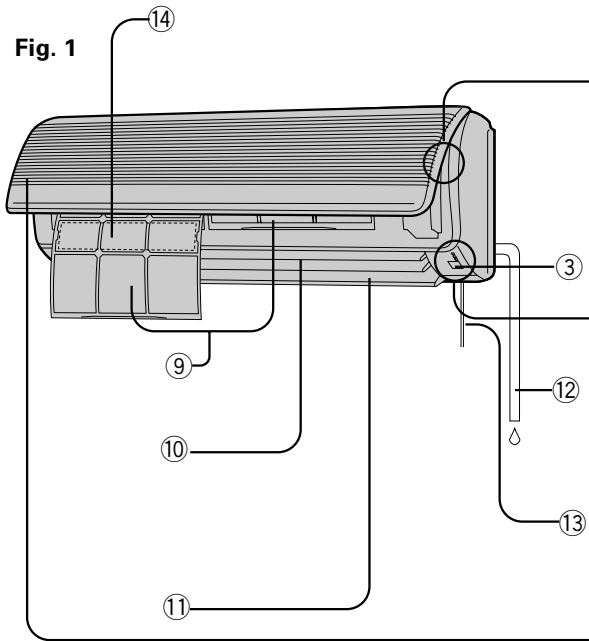

Fig. 2

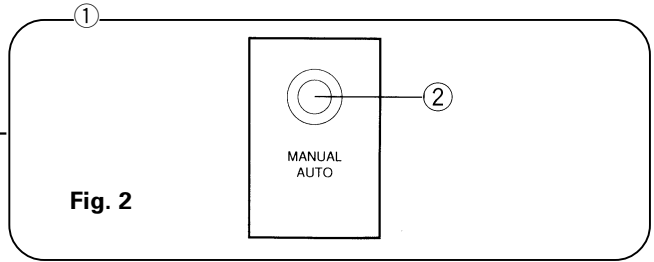

Fig. 3

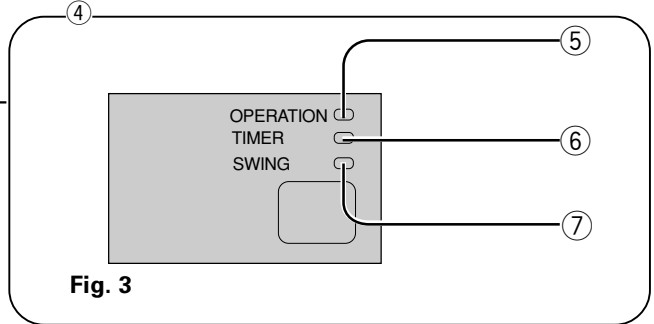

Fig. 4

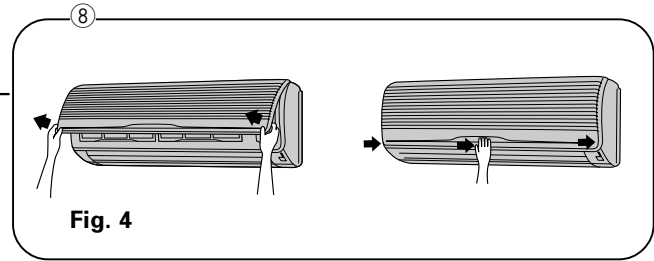

Fig. 5

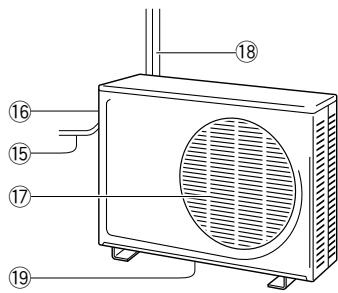

Fig. 6

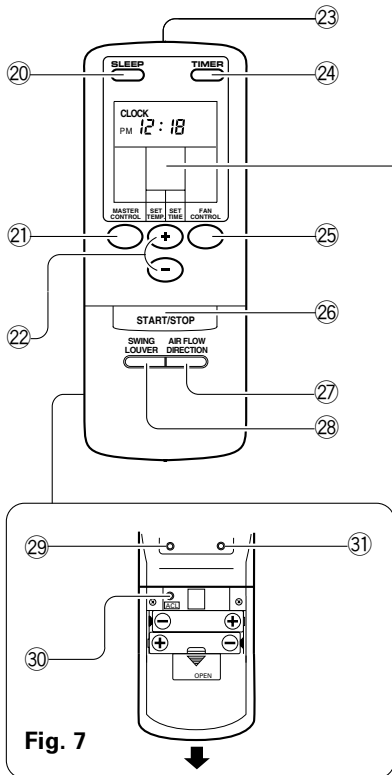

Fig. 7

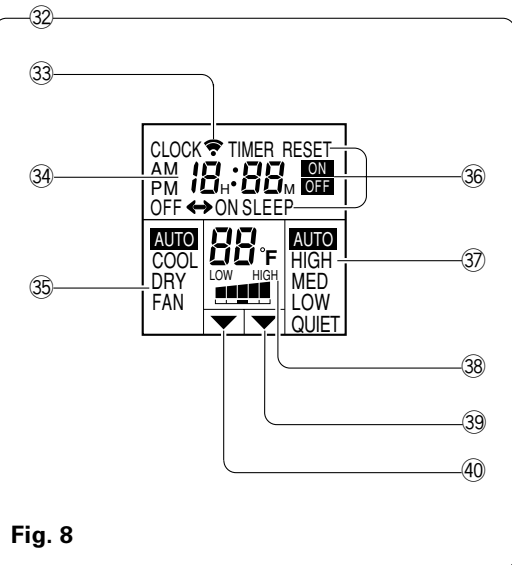



Fig. 8

CONTENTS

SAFETY PRECAUTIONS	En-1	ADJUSTING THE DIRECTION OF	
FEATURES AND FUNCTIONS	En-4	AIR CIRCULATION	En-11
NAME OF PARTS	En-5	SWING OPERATION	En-12
PREPARATION	En-6	MANUAL AUTO OPERATION	En-12
OPERATION	En-7	CLEANING AND CARE	En-13
TIMER OPERATION	En-9	TROUBLESHOOTING	En-16
SLEEP TIMER OPERATION	En-10	OPERATING TIPS	En-17

SAFETY PRECAUTIONS

- Before using the appliance, read these "SAFETY PRECAUTIONS" thoroughly and operate in the correct way.
- The instructions in this section all relate to safety; be sure to maintain safe operating conditions.
- "CAUTION" and "WARNING" have the following meanings in these instructions:





 WARNING	This mark indicates procedures which, if improperly performed, might lead to the death or serious injury of the user.
 CAUTION	This mark indicates procedures which, if improperly performed, might possibly result in personal harm to the user, or damage to property.

Safety Symbols





 △ The triangular symbol indicates WARNING, CAUTION and DANGER items.

 ⊘ This symbol indicates prohibited operations. The prohibited action is indicated both within the symbol, and in nearby explanations.

 ● This symbol indicates instructions regarding operations which are to be performed by the user.

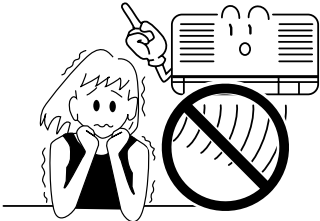
 WARNING	
Do not attempt to install this air conditioner by yourself.	
<ul style="list-style-type: none"> ● Consult authorized service personnel for all installations. 	
Consult authorized service personnel for any repairs.	
<ul style="list-style-type: none"> ● Do not attempt to remove parts, or service the unit yourself, since you may be exposed to dangerous electrical shock. This appliance contains no user-serviceable parts. 	
When moving, consult authorized service personnel for disconnection and installation of the unit.	

PRECAUTIONS

 WARNING	
<p>Do not stay in direct cooling airflow for long periods.</p> <ul style="list-style-type: none"> ● Excessive direct exposure to chilled air could be bad for your health. ● Be especially careful when going to bed, and in rooms where infants, aged, or sick people are staying. 	
	
<p>Do not insert fingers or objects into the outlet port or intake grilles.</p> <ul style="list-style-type: none"> ● A fan operates at high speed inside the unit, and personal injury could result. ● Be particularly careful regarding small children. 	
	
<p>In the event of a malfunction (burning smell, etc.), immediately stop operation, disconnect the power, and <u>consult authorized service personnel</u>.</p> <ul style="list-style-type: none"> ● Continuing to operate the unit under such conditions could lead to hazard of fire or electrical shock. 	
	
 CAUTION	
<p>Be careful to provide adequate ventilation particularly when using the unit in combination with other heating apparatus.</p> <ul style="list-style-type: none"> ● Insufficient ventilation could lead to oxygen starvation. 	<p>Do not place animals or plants in the direct path of the air flow.</p>
<p>Do not climb on, or place objects on, the air conditioner.</p> <ul style="list-style-type: none"> ● Personal injury could result from a falling object, or if the unit tips over. 	<p>Do not direct air flow at fireplaces or heating apparatuses.</p> <ul style="list-style-type: none"> ● Direct air blowing on fires could result in improper combustion or fire.
<p>Do not hang on or cover the air conditioner.</p>	<p>Do not set flower vases or water containers on top of air conditioners.</p> <ul style="list-style-type: none"> ● Water leaking inside the unit could damage electrical insulation, leading to danger of electrical shock.
<p>Do not expose the air conditioner directly to water.</p> <ul style="list-style-type: none"> ● Electrical insulation could be damaged, resulting in electrical shock. 	<p>Do not operate the air conditioner with wet hands.</p> <ul style="list-style-type: none"> ● Electrical shock could result.

PRECAUTIONS

 CAUTION	
<p>Turn off power source when not using the unit for extended periods.</p>	<p>Always turn off power whenever cleaning the air conditioner or changing the air filter.</p> <ul style="list-style-type: none"> ● A fan operates at high speed inside the unit, and personal injury could result.
<p>Take precautions to prevent infants from accidentally swallowing batteries.</p>	<p>Check the condition of the installation for damage.</p> <ul style="list-style-type: none"> ● After lengthy use, arrange for visit by authorized service personnel to check installation condition.
<p>Do not drink the water drained from the air conditioner.</p>	<p>Do not use in applications involving the storage of foods, plants or animals, precision equipment, or art works.</p> <ul style="list-style-type: none"> ● The quality of the stored items may deteriorate.
<p>Take out the batteries from the remote control unit when not using for a long time.</p> <ul style="list-style-type: none"> ● Take out the batteries to prevent troubles caused by battery liquid leakage. ● If leaking battery fluid comes in contact with your skin, eyes, or mouth, immediately wash with copious amounts of water, and consult your physician. 	<p>Do not touch the heat exchanger radiator fins.</p> <ul style="list-style-type: none"> ● Personal injury could result. ● Be particularly careful when cleaning. ● Bending or damage to the fins will affect the efficiency of the unit.
<p>Always operate with the air filter installed.</p> <ul style="list-style-type: none"> ● Operating the unit without the air filter could cause excessive dirt to collect on internal parts, leading to malfunction. 	<p>Do not block or cover the intake grille and outlet port.</p> <ul style="list-style-type: none"> ● Obstructing the ports will reduce operating efficiency, leading to improper operation and possible damage.
<p>Install the indoor unit and remote control unit at least one meter from any television sets or radio.</p> <ul style="list-style-type: none"> ● Signal radiation could be induced into the system to give erroneous operation. 	<p>Avoid installing the air conditioner near a fireplace or other heating apparatus.</p> <ul style="list-style-type: none"> ● Exposure to excessive heat could result in deformation of the outer case.
<p>When installing the indoor unit and outdoor unit, take precautions to prevent access by infants.</p> <ul style="list-style-type: none"> ● Unexpected accidents could occur. 	<p>Be sure to attach the intake grille securely.</p>
<p>Do not use inflammable gases near the air conditioner.</p>	

FEATURES AND FUNCTIONS

AUTOMATIC OPERATION

Merely press the START/STOP button, and the unit will begin automatic operation in either the Heating, Cooling, Dry, or Monitor modes as appropriate, in accordance with the thermostat setting and the actual temperature of the room.

SLEEP TIMER

When the SLEEP timer button is pressed during cooling mode, the thermostat setting is gradually raised during the period of operation. When the set time is reached, the unit automatically turns off.

WIRELESS REMOTE CONTROL UNIT

The WIRELESS REMOTE CONTROL UNIT allows convenient control of air conditioner operation.

SWING OPERATION

The Air Flow Direction Louvers swings automatically up and down so that the air speeds to every nook and corner of your room.

REMOVABLE INTAKE GRILLE

The indoor unit's INTAKE GRILLE can be removed for easy cleaning and maintenance.

MILDEW-RESISTANT FILTER

The AIR FILTER has been treated to resist mildew growth, thus allowing cleaner use and easier care.

SUPER QUIET OPERATION

When the FAN CONTROL button is used to select QUIET, the unit begins super-quiet operation; the indoor unit's airflow is reduced for quieter operation.

NAME OF PARTS

Fig. 1 Indoor Unit

- ① **Operating Control Panel (Fig. 2)**
- ② **MANUAL AUTO button**

- ③ **Remote Control Signal Receiver**

- ④ **Indicator Lamps (Fig. 3)**
- ⑤ **OPERATION Indicator Lamp (red)**
- ⑥ **TIMER Indicator Lamp (green)**
 - If the TIMER Indicator Lamp flashes when the timer is operating, it indicates that a fault has occurred with the timer setting (See Page 17 Auto Restart).
- ⑦ **SWING Indicator Lamp (orange)**

- ⑧ **Intake Grille (Fig. 4)**
- ⑨ **Air Filter**
- ⑩ **Air Flow Direction Louver**
- ⑪ **Right-Left Louvers**
(behind Air Flow Direction Louver)
- ⑫ **Drain Hose**
- ⑬ **Inter Unit-Line**
- ⑭ **Air Cleaning Filter (optional)**

Fig. 5 Outdoor Unit

- ⑮ **Power Supply**
- ⑯ **Intake Port**
- ⑰ **Outlet Port**
- ⑱ **Pipe Unit**
- ⑲ **Drain port (bottom)**

Fig. 6 Remote Control Unit

- ⑳ **SLEEP button**
- ㉑ **MASTER CONTROL button**
- ㉒ **SET TEMP. /SET TIME button (+ / -)**
- ㉓ **Signal Transmitter**
- ㉔ **TIMER button**
- ㉕ **FAN CONTROL button**
- ㉖ **START / STOP button**
- ㉗ **AIR FLOW DIRECTION button**
- ㉘ **SWING LOUVER button**

Rear side (Fig. 7)

- ㉙ **TIME ADJUST button**
- ㉚ **ACL button**
(located inside battery compartment)
- ㉛ **TEST RUN button**
 - This button is used when installing the unit, and should not be used under normal conditions, as it will cause the air conditioner's thermostat function to operate incorrectly.
 - If this button is pressed during normal operation, the unit will switch to test operation mode, and the Indoor Unit's OPERATION Indicator Lamp and TIMER Indicator Lamp will begin to flash simultaneously.
 - To stop the test operation mode, press the START/STOP button to stop the air conditioner.

㉜ Remote Control Unit Display (Fig. 8)

- ㉜ **Transmit Indicator**
- ㉝ **Clock Display**
- ㉞ **Operating Mode Display**
- ㉟ **Timer Mode Display**
- ㊱ **Fan Speed Display**
- ㊲ **Temperature Set Display**
- ㊳ **Timer Set Indicator**
- ㊴ **Temperature Set Indicator**

PREPARATION

Turn on the Power

In the case of a direct line connection, turn on the circuit breaker.

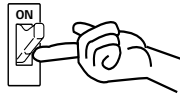

Load Batteries (AAA x 2)

1 Press and slide the battery compartment lid on the reverse side to open it.

Slide in the direction of the arrow while pressing the ▼ mark.

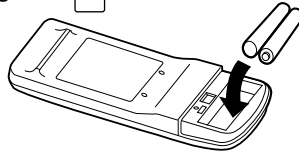

2 Insert batteries.

Be sure to align the battery polarities (+/−) correctly.

3 Close the battery compartment lid.

Set the Current Time

1 Press the TIME ADJUST button (Fig. 7 29).

Use the tip of a ball-point pen or other small object to press the button.

2 Use the (+) / (−) SET TEMP. SET TIME buttons (Fig. 6 22) to adjust the clock to the current time.

(+) button: Press to advance the time.

(−) button: Press to reverse the time.

(Each time the buttons are pressed, the time will be advanced/reversed in one-minute steps; hold the buttons depressed to change the time quickly in ten-minute steps).

3 Press the TIME ADJUST button again.

This completes the time setting and starts the clock.

⚠ CAUTION!

- Take care to prevent infants from accidentally swallowing batteries.
- When not using the remote control unit for an extended period, remove the batteries to avoid possible leakage and damage to the unit.
- If leaking battery fluid comes in contact with your skin, eyes, or mouth, immediately wash with copious amounts of water, and consult your physician.
- Dead batteries should be removed quickly and disposed of properly, either by placing in a public battery collection receptacle, or by returning to appropriate authority.
- Do not attempt to recharge dry batteries.

Never mix new and used batteries, or batteries of different types. Batteries should last about one year under normal use. If the remote control unit's operating range becomes appreciably reduced, replace the batteries and press the ACL button (Fig. 7 30) with the tip of a ballpoint pen or other small object.

To Use the Remote Control Unit

- The Remote Control Unit must be pointed at signal receiver (Fig. 1 3) to operate correctly.
- Operating Range: About 7 meters.
- When a signal is properly received by the air conditioner, a beep be heard.
- If no beep is heard, press the Remote Control Unit button again.

Remote Control Unit Holder

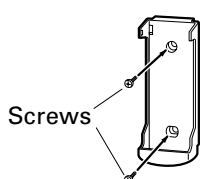

① Mount the Holder.

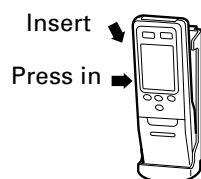

② Set the Remote Control Unit.

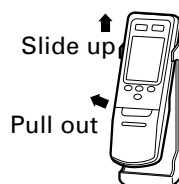

③ To remove the Remote Control Unit.

OPERATION

To Select Mode Operation

- 1 Press the START/STOP button (Fig. 6 26).**
The Indoor Unit's OPERATION Indicator Lamp (red) (Fig.3 5) will light.
The air conditioner will start operation.
- 2 Press the MASTER CONTROL button (Fig.6 21) to select the desired mode.**
Each time the button is pressed, the mode will change in the following order.



About three seconds later, the entire display will reappear.

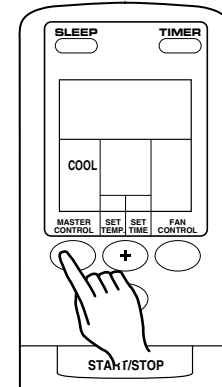

Example: When set to COOL

To Set the Thermostat

Press the TEMPERATURE set button.

- + button: Press to increase the thermostat setting.
- button: Press to lower the thermostat setting.

● Thermostat setting range:

- Cooling/Drying 64°F to 88°F
- Fan..... 62°F to 88°F

About three seconds later, the entire display will reappear.

NOTE:

- The thermostat setting should be considered a standard value, and may differ somewhat from the actual room temperature.
- During Fan mode, set the unit to "--" for continuous fan operation regardless of room temperature.

The thermostat setting should be considered a standard value, and may differ somewhat from the actual room temperature.

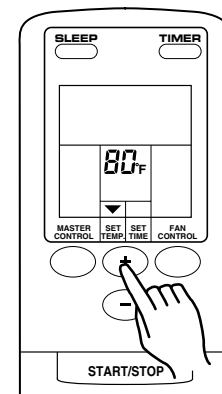

Example: When set to 80°F.

To Set the Fan Speed

Press the FAN CONTROL button (Fig. 6 25).

Each time the button is pressed, the fan speed changes in the following order:

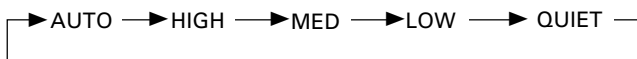

About three seconds later, the entire display will reappear.

When set to AUTO:

Cooling: As the room temperature approaches that of the thermostat setting, the fan speed becomes slower.

Fan: The fan will operate at the optimum speed in accordance with the room temperature in the vicinity of the indoor unit.

When set to QUIET:

SUPER QUIET operation begins. The indoor unit's airflow will be reduced for quieter operation.

- SUPER QUIET operation cannot be used during Dry mode. (The same is true when dry mode is selected during AUTO mode operation.)
- Cooling performance will be reduced somewhat during SUPER QUIET operation.

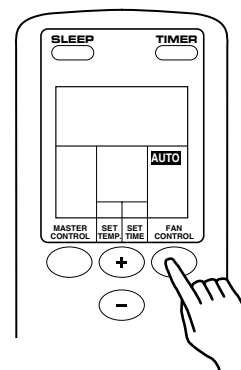

Example: When set to AUTO.

In order to increase the drying effect during quiet cooling operation, the fan of the indoor unit may stop.

OPERATION

To Select Automatic Operation

Press the **MASTER CONTROL** button to select **AUTO**.

The operating mode "AUTO" will appear alone in the display. The transmit indicator will flash to indicate the command has been sent, and about three seconds later the entire display panel will reappear.

To Set the Thermostat

Press the **TEMPERATURE** set button.

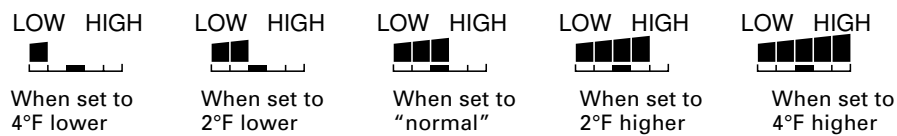

About three seconds later, the entire display will reappear.

NOTE: The thermostat setting should be considered a standard value, and may differ somewhat from the actual room temperature.

To Stop Operation

Press the **START/STOP** button.

The OPERATION indicator lamp (red) (Fig. 3 ⑤) will go out.

About Mode Operation

AUTO:

- Depending on the room temperature at the time operation begins, the operating mode will be switched automatically as shown in the accompanying table.
- Also, depending on the operating mode, the room temperature setting will cause the "standard" temperature to be set as shown.

Actual Room Temperature	Operating Mode	Thermostat Setting (standard setting)
88°F or above	Cooling	82°F
82°F to 88°F	Cooling	80°F
78°F to 82°F	Dry	76°F
74°F to 78°F	Dry	72°F
Below 74°F	Dry	68°F

The operating mode and standard thermostat settings are selected automatically when operation begins.

- When automatic operation is initiated, the fan will run at very low speed for about one minute while the unit detects and selects the proper operating mode.
- Once the operating mode has been set, the mode will not change even if the room temperature changes.
- If the START/STOP button is pressed to recommence operation within two hours after stopping automatic operation, the unit will begin operating from the same mode as before.

Cooling: Use to cool your room.

Dry:

- Use for gently cooling while dehumidifying your room.
- You cannot heat the room during Dry mode.
- During Dry mode, the unit will operate at low speed; in order to adjust room humidity, the indoor unit's fan may stop from time to time. Also, the fan may operate at very low speed when detecting room humidity.
- The fan speed cannot be changed manually when Dry mode has been selected.

Fan:

- Use to circulate warm air from ceiling area throughout room when using space heaters.

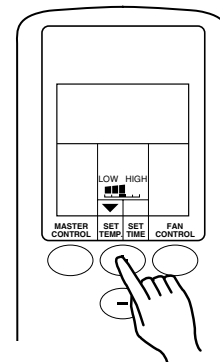
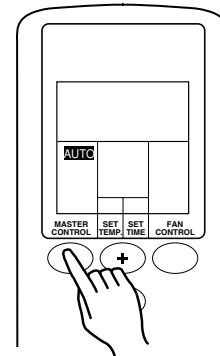

Example: When set to "normal".

During Cooling/Dry mode:
Set the thermostat to a temperature setting that is lower than the current room temperature. The Cooling and Dry modes will not operate if the thermostat is set higher than the actual room temperature (in Cooling mode, the fan alone will operate).

During Fan mode:

- Fan operation begins when room temperature in the vicinity of the air conditioner rises above the set thermostat temperature; when the temperature drops, fan operation stops.
- If the air emitted feels too cool, raise the thermostat setting.

TIMER OPERATION

Before using the timer function, be sure that the Remote Control Unit is set to the correct current time (See Page 6).

To Use the ON timer or OFF timer

1 Press the START/STOP button (Fig. 6 ②⑥). (if the unit is already operating, proceed to step 2).

The indoor unit's OPERATION Indicator Lamp (red) (Fig. 3 ⑤) will light.

2 Press the TIMER button (Fig. 6 ②④) to select the OFF timer or ON timer operation.

Each time the button is pressed the timer function changes in the following order:

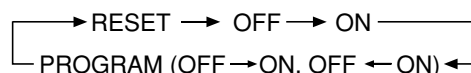

The indoor unit's TIMER Indicator lamp (green) (Fig. 3 ⑥) will light.

3 Use the SET TEMP.SET TIME button (Fig. 6 ②②) to adjust the desired OFF time or ON time.

Set the time while the time display is flashing (the flashing will continue for about five seconds).

+ button: Press to advance the time.

- button: Press to reverse the time.

About five seconds later, the entire display will reappear.

To Cancel the Timer

Use the TIMER button to select "TIMER RESET."

The air conditioner will return to normal operation.

To Change the Timer Setting

Perform steps 2 and 3.

To Stop Air Conditioner Operation while the Timer is Operating

Press the START/STOP button.

To Change Operating Conditions

If you wish to change operating conditions (Mode, Fan Speed, Thermostat Setting), after making the timer setting wait until the entire display reappears, then press the appropriate buttons to change the operating condition desired.

To Use the Program timer

1 Press the START/STOP button (Fig. 6 ②⑥). (if the unit is already operating, proceed to step 2).

The indoor unit's OPERATION Indicator Lamp (red) (Fig. 3 ⑤) will light.

2 Set the desired times for OFF timer and ON timer.

See the section "To Use the ON Timer or OFF Timer" to set the desired mode and times.

About three seconds later, the entire display will reappear.

The indoor unit's TIMER Indicator Lamp (green) (Fig. 3 ⑥) will light.

3 Press the TIMER button (Fig. 6 ②④) to select the PROGRAM timer operation (either OFF → ON or OFF ← ON will display).

The display will alternately show "OFF timer" and "ON timer", then change to show the time setting for the operation to occur first.

- The PROGRAM timer will begin operation. (If the ON timer has been selected to operate first, the unit will stop operating at this point).

About five seconds later, the entire display will reappear.

To Cancel the Timer

Use the TIMER button to select "TIMER RESET."

The air conditioner will return to normal operation.

To Change the Timer Setting

1. Follow the instructions given in the section "To Use the ON Timer or OFF Timer" to select the timer setting you wish to change.
2. Press the TIMER button to select either OFF → ON or OFF ← ON.

To Stop Air Conditioner Operation while the Timer is Operating

Press the START/STOP button.

To Change Operating Conditions

If you wish to change operating conditions (Mode, Fan Speed, Thermostat Setting), after making the timer setting wait until the entire display reappears, then press the appropriate buttons to change the operating condition desired.

About the Program timer

- The PROGRAM timer allows you to integrate OFF timer and ON timer operations in a single sequence. The sequence can involve one transition from OFF timer to ON timer, or from ON timer to OFF timer, within a twenty-four hour period.
- The first timer function to operate will be the one set nearest to the current time. The order of operation is indicated by the arrow in the Remote Control Unit's display (OFF → ON, or OFF ← ON).
- One example of Program timer use might be to have the air conditioner automatically stop (OFF timer) after you go to sleep, then start (ON timer) automatically in the morning before you arise.

SLEEP TIMER OPERATION

Unlike other timer functions, the SLEEP timer is used to set the length of time until air conditioner operation is stopped.

To Use the SLEEP Timer

While the air conditioner is operating or stopped, press the SLEEP button (Fig. 6 ⑳).

The indoor unit's OPERATION Indicator Lamp (red) (Fig 3. ⑤) lights and the TIMER Indicator Lamp (green) (Fig 3. ⑥) light.

To Change the Timer Setting

Press the SLEEP button (Fig 6. ⑳) once again and set the time using the SET TIME buttons (Fig 6. ㉑).

Set the time while the Timer Mode Display is flashing (the flashing will continue about five seconds).

+ button: Press to advance the time.

- button: Press to reverse the time.

About five seconds later, the entire display will reappear.

To Cancel the Timer:

Use the TIMER button to select "TIMER RESET".
The air conditioner will return to normal operation.

To Stop the Air Conditioner During Timer Operation:

Press the START/STOP button.

About the SLEEP timer

To prevent excessive cooling during sleep, the SLEEP timer function automatically modifies the thermostat setting in accordance with the time setting. When the set time has elapsed, the air conditioner completely stops.

During Cooling/Dry operation:

When the SLEEP timer is set, the thermostat setting is automatically raised 2°F every sixty minutes. When the thermostat has been raised a total of 4°F, the thermostat setting at that time is maintained until the set time has elapsed, at which time the air conditioner automatically turns off.

SLEEP timer setting

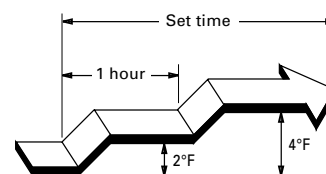

ADJUSTING THE DIRECTION OF AIR CIRCULATION

Vertical (up-down) direction of airflow is adjusted by pressing the Remote Control Unit's AIR FLOW DIRECTION button. Horizontal (right-left) airflow direction is adjusted manually, by moving the Air Flow Direction Louvers. Whenever making horizontal airflow adjustments, start air conditioner operation and be sure that the vertical air direction louvers are stopped.

Vertical Air Direction Adjustment

Press the AIR FLOW DIRECTION button (Fig. 6 ⑰).

Each time the button is pressed, the air direction range will change as follows:

Cooling/ Dry mode	① ⇄ ② ⇄ ③ ⇄ (⑥) ^{NOTE}	
Fan mode	③ ⇄ ② ⇄ ① ⇄ ⑦ ⇄ ⑥ ⇄ ⑤ ⇄ ④	

- Use the air direction adjustments within the ranges shown above.
- The vertical airflow direction is set automatically as shown, in accordance with the type of operation selected.
 - During Cooling/Dry mode: Horizontal flow ①
 - During Fan mode: Downward flow ⑥
- During AUTO mode operation, for the first minute after beginning operation, airflow will be horizontal ①; the air direction cannot be adjusted during this period.

NOTE

You can select the air direction ①, ②, ③, or ⑥ (downward) by pressing the AIR FLOW DIRECTION button.
Use the air direction ⑥ when you want to cool yourself for a while after taking a bath or shower, or after coming back home in summer months.
But, for prevention of condensation on the louver, the air direction ⑥ is automatically released after 30 minutes and turned to the air direction ③.

CAUTION

- Never place fingers or foreign objects inside the outlet ports, since the internal fan operates at high speed and could cause personal injury.

- Always use the remote control unit's AIR FLOW DIRECTION button to adjust the vertical airflow louvers. Attempting to move them manually could result in improper operation; in this case, stop operation and restart. The louvers should begin to operate properly again.

- When used in a room with infants, children, elderly or sick persons, the air direction and room temperature should be considered carefully when making settings.

Right-Left Adjustment

Adjust the Right-Left Louvers

- Move the Right-Left Louvers to adjust air flow in the direction you prefer.

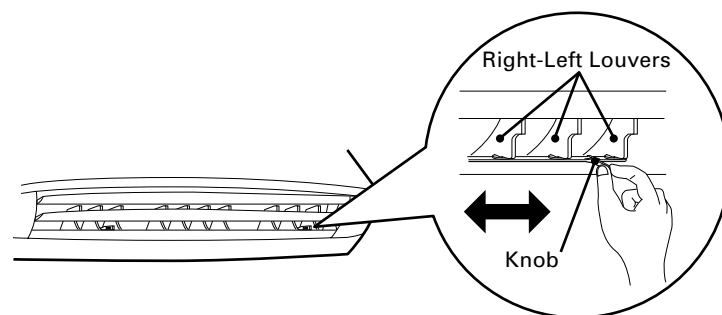

SWING OPERATION

Begin air conditioner operation before performing this procedure.

To Select SWING Operation

Press the **SWING LOUVER** button (Fig.6 ⑳).

The SWING Indicator Lamp (orange) (Fig. 3 ㉑) will light.
In this mode, the Air Flow Direction Louvers will swing automatically to direct the airflow both up and down.

To Stop SWING Operation

Press the **SWING LOUVER** button (Fig.6 ㉑) once again.

The SWING Indicator Lamp (orange) (Fig. 3 ㉑) will go out.
Airflow direction will return to the setting before swing was begun.

About Swing Operation

- The SWING range is as follows:

Cooling/ Dry mode	① ⇄ ③ , (④ ⇄ ⑦) ^{NOTE}	
Fan mode	① ⇄ ③ , ④ ⇄ ⑦	

- The SWING operation may stop temporarily when the air conditioner's fan is not operating or when operating at very low speeds.
- The airflow direction can not be adjusted during SWING operation even when the AIR FLOW DIRECTION button is pressed.

NOTE

The air swings between ④ and ⑦ by pressing the SWING LOUVER button after selecting the air direction ⑥ (downward) by pressing the AIR FLOW DIRECTION button.

Use this operation when you want to cool yourself for a while after taking a bath or shower, or after coming back home in summer months.

But, for prevention of condensation on the louver, the swing of the air direction ④ ↔ ⑦ is automatically released after 30 minutes and turned to the swing of the air direction ① ↔ ③.

MANUAL AUTO OPERATION

Use the MANUAL AUTO operation in the event the Remote Control Unit is lost or otherwise unavailable.

How To Use the Main Unit Controls

Press the **MANUAL AUTO** button (Fig. 2 ㉒) on the main unit control panel.

To stop operation, press the MANUAL AUTO button once again.

(Controls are located inside the Intake Grille)

- When the air conditioner is operated with the controls on the Main Unit, it will operate under the same mode as the AUTO mode selected on the Remote Control Unit (see page 8).
- The fan speed selected will be "AUTO" and the thermostat setting will be standard.

CLEANING AND CARE



WARNING

Before cleaning the unit, be sure to stop the unit and disconnect the power.

1. Disconnect the power.
 2. Turn off the electrical breaker.
- A fan operates at high speed inside the unit, and personal injury could result.

When cleaning the air conditioner, turn off the electrical breaker.

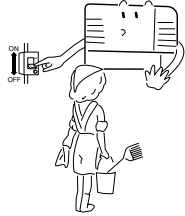

Never use water that is hotter than 100°F. The body may warp or change color.



The unit can be damaged by gasoline, benzine, thinners, insecticides and other chemical agents.



Do not use inflammable sprays such as lacquer or hair spray near the air conditioner.

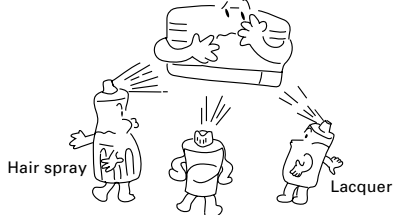

Cleaning the Indoor Unit

Clean the indoor unit by wiping with a cloth dipped in cool or warm water, then wipe with another soft, clean, dry cloth.

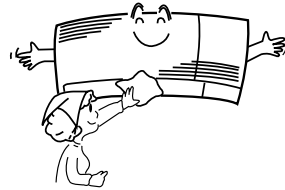

When Not Using the Unit for Extended Periods (One Month or More)

Operate the unit on fan mode for about one-half day on a day with clear weather, to assure that the internal parts are dry (see page 7).



CAUTION

When not using the unit for extended periods, disconnect the power for safety.

Inspections and Repairs

Depending on the conditions of use, the internal parts of an air conditioner will become dirty after about two or three seasons of use, and performance may be affected. For this reason, regular professional maintenance is recommended. Consult authorized service personnel.

Cleaning the Intake Grille

1. Open the Intake Grille.

- ① Place your fingers at both lower ends of the grille panel, and lift forward; if the grille seems to catch partway through its movement, continue lifting upward to remove.
- ② Pull past the intermediate catch and open the Intake Grille wide so that it becomes horizontal.

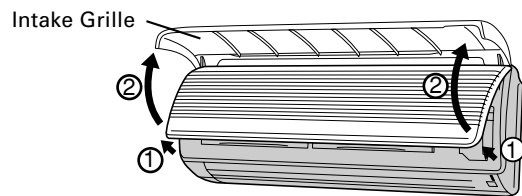

2. Unlock the Intake Grille.

Hold the Intake Grille with one hand and pull the Knobs on the right and the left all the way to unlock the Intake Grille.

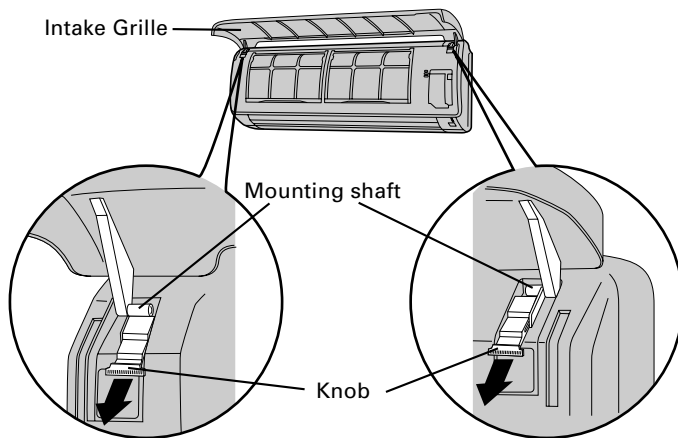

Raise the horizontal Intake Grille to remove it.

3. Clean with water.

Remove dust with a vacuum cleaner; wipe the unit with warm water, then dry with a clean, soft cloth.

4. Set the mounting shaft of the Intake Grille into the bearings at the top of the panel.

- ① Pull the Knobs all the way.
- ② Hold the grille horizontal and set the left and right mounting shafts into the bearings at the top of the panel.

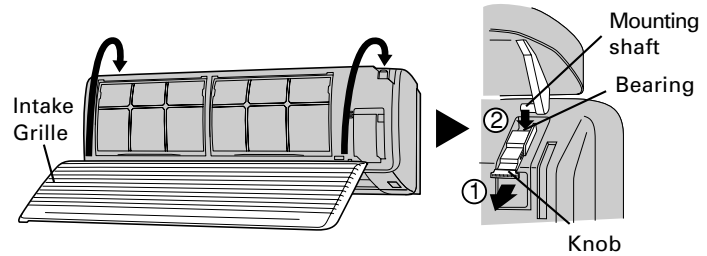

5. Lock the Intake Grille.

Hold the Intake Grille with one hand and push the Knobs on the right and the left all the way in to lock the Intake Grille mounting shafts.

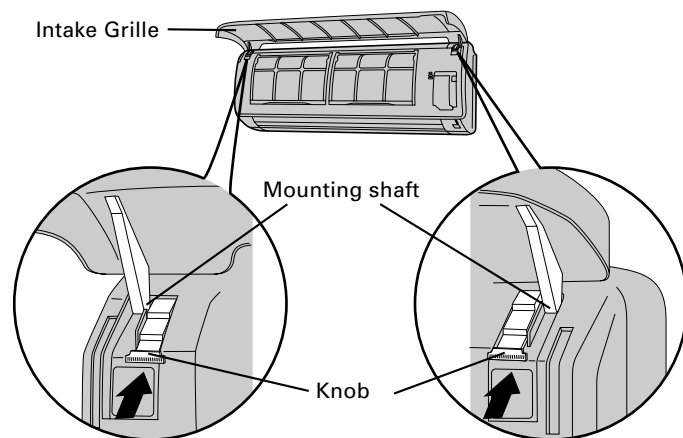

6. Close the Intake Grille.

Push the lower edge of the Intake Grille at both ends and at the center to close it.

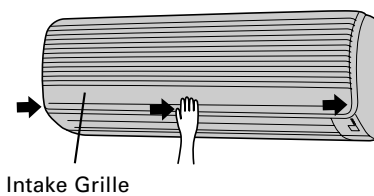

⚠ CAUTION

Do not operate with open Intake Grille, as this can cause accidents.

CLEANING AND CARE

Cleaning the Air Filter

1. Open the Intake Grille, and remove the Air Filter.

Lift up the air filter's handle, disconnect the two lower tabs and pull out.

Air filter handle

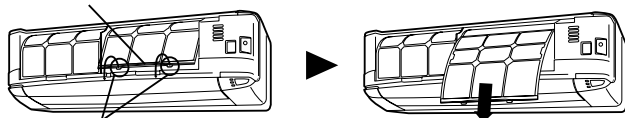

Hooks (two places)

2. Remove dust with a vacuum cleaner or by washing.

After washing, allow to dry thoroughly in a shaded place.

3. Replace the Air Filter and close the Intake Grille.

① Align the sides of the Air Filter with the panel, and push in fully, making sure the two lower tabs are returned properly to their holes in the panel.

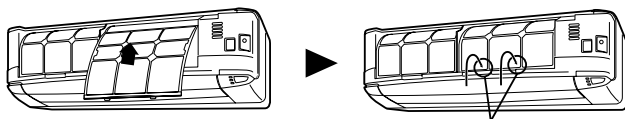

② Close the Intake Grille.

Hooks (two places)

(For purposes of example, the illustration shows the unit without Intake Grille installed.)

- Dust can be cleaned from the Air Filter either with a vacuum cleaner, or by washing the filter in a solution of mild detergent and warm water. If you wash the filter, be sure to allow it to dry thoroughly in a shady place before reinstalling.
- If dirt is allowed to accumulate on the Air Filter, air flow will be reduced, lowering operating efficiency and increasing noise.
- During periods of normal use, the Air Filters should be cleaned every two weeks.

When using the optional Air Cleaning Filter

- Install the optional Air Cleaning Filter set (UTR-FA03) as instructed (Instruction Manual are furnished with the Air Cleaning Filter set).

- When used for extended periods, the unit may accumulate dirt inside, reducing its performance. We recommend that the unit be inspected regularly, in addition to your own cleaning and care. For more information, consult authorized service personnel.
- When cleaning the unit's body, do not use water hotter than 40°C, harsh abrasive cleansers, or volatile agents like benzene or thinner.
- Do not expose the unit body to liquid insecticides or hairsprays.
- When shutting down the unit for one month or more, first allow the fan mode to operate continuously for about onehalf day to allow internal parts to dry thoroughly.

TROUBLE SHOOTING



WARNING!

In the event of a malfunction (burning smell, etc.), immediately stop operation, disconnect the Power and consult authorized service personnel.
Merely turning off the unit's power switch will not completely disconnect the unit from the power source. Always be sure to disconnect the Power or turn off your circuit breaker to ensure that power is completely off.

Before requesting service, perform the following checks:

	Symptom	Problem	See Page
NORMAL FUNCTIONS	Doesn't operate immediately:	<ul style="list-style-type: none"> ● If the unit is stopped and then immediately started again, the compressor will not operate for about 3 minutes, in order to prevent fuse blowouts. ● Whenever the Power is disconnected and then reconnected to a power outlet, the protection circuit will operate for about 3 minutes, preventing unit operation during that period. 	—
	Noise is heard:	<ul style="list-style-type: none"> ● During operation and immediately after stopping the unit, the sound of water flowing in the air conditioner's piping may be heard. Also, noise may be particularly noticeable for about 2 to 3 minutes after starting operation (sound of coolant flowing). ● During operation, a slight squeaking sound may be heard. This is the result of minute expansion and contraction of the front cover due to temperature changes. 	—
	Smells:	<ul style="list-style-type: none"> ● Some smell may be emitted from the indoor unit. This smell is the result of room smells (furniture, tobacco, etc.) which have been taken into the air conditioner. 	—
	Mist or steam are emitted:	<ul style="list-style-type: none"> ● During Cooling or Dry operation, a thin mist may be seen emitted from the indoor unit. This results from the sudden Cooling of room air by the air emitted from the air conditioner, resulting in condensation and misting. 	—
	Airflow is weak or stops:	<ul style="list-style-type: none"> ● The fan may operate at very low speed during Dry operation or when the unit is monitoring the room's temperature. 	7
		<ul style="list-style-type: none"> ● During SUPER QUIET operation, the fan will operate at very low speed. 	7
<ul style="list-style-type: none"> ● In the monitor AUTO operation, the fan will operate at very low speed. 		7	

TROUBLE SHOOTING

	Symptom	Items to Check	See Page
CHECK ONCE MORE	Doesn't operate at all:	<ul style="list-style-type: none"> ● Has there been a power failure? ● Has a fuse blown out, or a circuit breaker been tripped? 	—
		<ul style="list-style-type: none"> ● Is the POWER switch set to the OFF position? 	6
		<ul style="list-style-type: none"> ● Is the timer operating? 	9 - 10
	Poor Cooling performance:	<ul style="list-style-type: none"> ● Is the air filter dirty? ● Are the air conditioner's intake grille or outlet port blocked? ● Did you adjust the room temperature settings (thermostat) correctly? ● Is there a window or door open? ● Is a window allowing bright sunlight to enter? (Close the curtains.) ● Are there heating apparatus and computers inside the room, or are there too many people in the room? 	—
		<ul style="list-style-type: none"> ● Is the unit set for SUPER QUIET operation? 	
The unit operates differently from the remote control unit's setting:	<ul style="list-style-type: none"> ● Are the Remote Control Unit's batteries dead? ● Are the Remote Control Unit's batteries loaded properly? 	7 6	



WARNING!

If the problem persists after performing these checks, or if you notice burning smells, or the TIMER Indicator Lamp (Fig. 3, ⑥) flashes, immediately stop operation, disconnect the Power and consult authorized service personnel.

OPERATING TIPS

Operation and Performance

In Event of Power Interruption

Auto Restart

- The air conditioner power has been interrupted by a power failure. The air conditioner will then restart automatically in its previous mode when the power is restored.
- Operated by settings before the power failure. Then, the Air Flow Direction Louvers will automatically change to their standard direction.
- If a power failure occurs during TIMER operation, the timer will be reset and the unit will begin (or stop) operation at the new time setting. In the event that this kind of timer fault occurs, the TIMER Indicator Lamp (green) will flash (see page 5).
- Use of other electrical appliances (electric shaver, etc.) or nearby use of a wireless radio transmitter may cause the air conditioner to malfunction. In this event, temporarily disconnect the Power, reconnect it, and then use the Remote Control Unit to resume operation.

OPERATING TIPS

Temperature and Humidity Range

		Cooling and Dry Mode
Indoor temperature	Maximum	95°F DB / 71°F WB
	Minimum	64°F DB / 55°F WB
Outdoor temperature	Maximum	115°F DB
	Minimum	32°F DB
Indoor humidity	Outdoor Temperature 68°F or above	About 80% or less If the unit is used for long periods under high-humidity conditions, condensation may form on the surface of the indoor unit, and drip onto the floor or other objects underneath.
	Outdoor Temperature below 68°F	About 50% or less If the unit is used for long periods under high-humidity conditions, condensation may form on the surface of the indoor unit, and drip onto the floor or other objects underneath.

DB : Dry Bulb Temperature
WB : Wet Bulb Temperature

- If the air conditioner is used under higher temperature conditioner than those listed, the built-in protection circuit may operate to prevent internal circuit damage. Also, during Cooling and Dry modes, if the unit is used under conditions of lower temperature than those listed above, the heat-exchanger may freeze, leading to water leakage and other damage.
- Do not use this unit for any purposes other than the Cooling, and Dehumidifying, and air-circulation of rooms in ordinary dwellings.



SPECIFICATIONS

MODEL		
INDOOR UNIT	MW09C1E	MW12C1E
OUTDOOR UNIT	MR09C1E	MR12C1E
TYPE	COOLING MODEL	COOLING MODEL
POWER	115V-60Hz	115V-60Hz
COOLING		
CAPACITY	9400BTU/h	12200BTU/h
INPUT	950W	1250W
CURRENT	9.0A	11.1A
REFRIGERANT	R22 1.50lbs.	R22 2.64lbs.

- These specifications listed in the above table were measured under the following conditions.

- TEMPERATURE

INDOOR	80° F DB / 67° F WB
OUTDOOR	95° F DB / 75° F WB

- Position of the AIRFLOW DIRECTION flap. For ADJUSTING THE DIRECTION OF AIR CIRCULATION on Page En-11, use position ②.
- PIPING LENGTH 25ft

FICHE TECHNIQUE

MODELE		
UNITE INTERIEURE	MW09C1E	MW12C1E
UNITE EXTERIEURE	MR09C1E	MR12C1E
TYPE	MODÈLE REFRIGERATION	MODÈLE REFRIGERATION
PUISSANCE	115V-60Hz	115V-60Hz
REFROIDISSEMENT		
CAPACITE	9400BTU/h	12200BTU/h
ENTREE	950W	1250W
INTENSITÉ	9,0A	11,1A
REFRIGERANT	R22 1,50lbs.	R22 2,64lbs.

- Ces spécifications figurant dans le tableau ci-dessus ont été mesurées sous les conditions suivantes.

- TEMPERATURE

INTERIEURE	80° F DB / 67° F WB
EXTERIEURE	95° F DB / 75° F WB

- Position du volet de direction de flux d'air. Pour le réglage de direction de circulation d'air à la page Fr-11, utiliser la position ②.
- LONGUEUR DE TUYAUTAG 25ft

ESPECIFICACIONES

MODELO		
UNIDAD INTERIOR	MW09C1E	MW12C1E
UNIDAD EXTERIOR	MR09C1E	MR12C1E
TIPO	MODELO DE REFRIGERACIÓN	MODELO DE REFRIGERACIÓN
ALIMENTACIÓN	115V-60Hz	115V-60Hz
REFRIGERACIÓN		
CAPACIDAD	9400BTU/h	12200BTU/h
ENTRADA	950W	1250W
CORRIENTE	9,0A	11,1A
REFRIGERANTE	R22 1,50lbs.	R22 2,64lbs.

- Las especificaciones mencionadas en la tabla de arriba se basan en las mediciones bajo las condiciones siguientes.

- TEMPERATURA

INTERIOR	80° F DB / 67° F WB
EXTERIOR	95° F DB / 75° F WB

- Posición para ajustar la lama deflectora de la DIRECCIÓN DEL FLUJO DE AIRE. Para el AJUSTE DE LA DIRECCIÓN DE CIRCULACIÓN DEL AIRE en la página Sp-11, emplee la posición ②.
- LONGITUD DE LOS TUBOS 25ft



Friedrich Air Conditioning Co.
4200 North Pan Am Expressway
Post Office Box 1540
San Antonio, Texas 78218
Tel. (210) 357-4400 FAX (210) 357-4480
Visit us at www.friedrich.com